



Scotchlok™

Moisture Resistant Self-Stripping Electrical Tap Connector 804

Data Sheet



Application

Use 3M™ Scotchlok™ Tap Connector 804 to electrically connect a (tap) wire end to a through (run) wire, insulate and provide a moisture resistant seal for the connection.

Wire Range

18-16 AWG (0,75-1,0 mm²) solid and stranded, 14 AWG (1,5 mm²) stranded tinned or untinned copper insulated conductors. For use with common thermoplastic insulated wires with a maximum insulation diameter of .145 inches (3,5 mm).

Maximum recommended current for general purpose applications: 18 AWG - 7 Amps, 16 AWG - 10 Amps, 14 AWG - 15 Amps

Construction

U-Contact - Tin plated brass, .03 in. (8mm) thick

Insulator - Polypropylene

Color - Blue

UL 94-V-2

Sealant - Mineral Oil Base

Dielectric Grease

Weight

.0042 lb. (1,90 gm)

Recommended Installation Tools

3M™ Crimping Tool No. E-9BM

9" Linemans Pliers

8" Mechanics (slip joint) pliers

Engineering Specification

Self-Stripping Electrical Tap Connector (as manufactured by 3M, part No. 804) capable of connecting a tap wire to a run wire and providing a moisture seal, in the wire range of 18-16 AWG (0,75-1,0 mm²) solid or stranded, and 14 AWG (1,5 mm²) stranded, tinned or untinned copper insulated wire, with a maximum insulation diameter, of .145 inches (3,5 mm). The connector shall be rated 600 volts and have an insulation temperature rating of 90°C (194°F).

Regulatory Agencies

UL Listed as a Pressure Cable Connector

Tested per UL Standard 486C

UL File No. E23438

Operating Temperature: 90°C (194°F)

Voltage Rating: 600 volts max. building wire;

1000 volts max. signs and fixtures

Federal Specification W-S-610:

"Commercial package only"

Type	Class	Kind	Style
1	1	cu	G

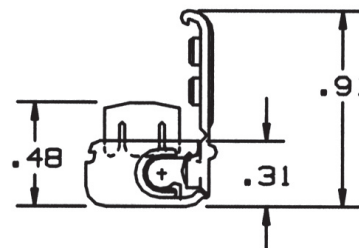
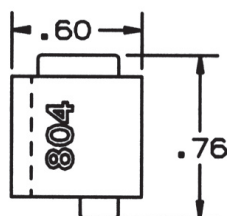

Installation Instructions

⚠ WARNING

Turn power off before installing or removing terminal. All electrical work should be done according to appropriate electrical codes.

1. Open hinged side wall.

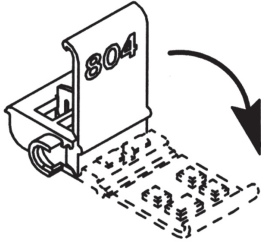

2. Place unstripped run wire inside run channel and close hinged side wall.

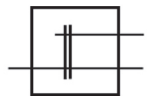
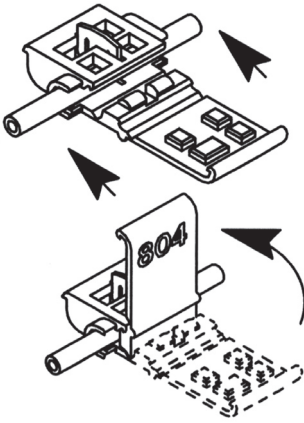

Tap Connector

3. Insert unstripped tap wire completely into tap port.

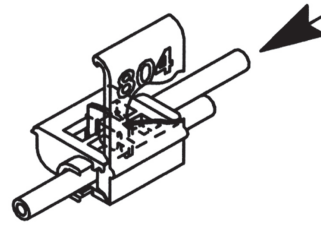

4. Hold tool perpendicular to the wire and make the connection by crimping the u-contact down flush with the top of the insulator.

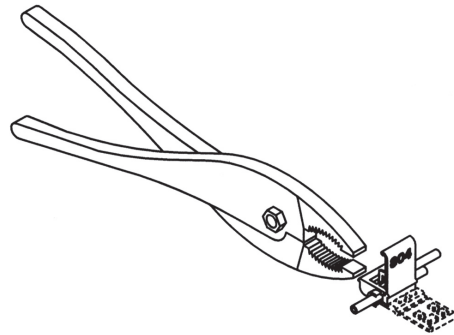

5. Close cover until latched.

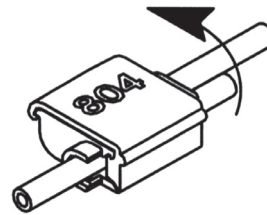

3M and Scotchlok are trademarks of 3M Company.



is a trademark of Underwriters Laboratories.

Important Notice

All statements, technical information, and recommendations related to 3M's products are based on information believed to be reliable, but the accuracy or completeness is not guaranteed. Before using this product, you must evaluate it and determine if it is suitable for your intended application. You assume all risks and liability associated with such use. Any statements related to the product which are not contained in 3M's current publications, or any contrary statements contained on your purchase order shall have no force or effect unless expressly agreed upon, in writing, by an authorized officer of 3M.

Warranty; Limited Remedy; Limited Liability.

This product will be free from defects in material and manufacture for a period of one (1) year from the time of purchase. **3M MAKES NO OTHER WARRANTIES INCLUDING, BUT NOT LIMITED TO, ANY IMPLIED WARRANTY OF MERCHANTABILITY OR FITNESS FOR A PARTICULAR PURPOSE.** If this product is defective within the warranty period stated above, your exclusive remedy shall be, at 3M's option, to replace or repair the 3M product or refund the purchase price of the 3M product. **Except where prohibited by law, 3M will not be liable for any indirect, special, incidental or consequential loss or damage arising from this 3M product, regardless of the legal theory asserted.**

3M

Electrical Markets Division

6801 River Place Blvd.
Austin, TX 78726-9000
800-626-8381
Fax 800-828-9329
www.3M.com/electrical



Recycled paper
40% Pre-consumer waste paper
10% Post-consumer waste paper

Litho in USA
© 3M 2006 78-8126-5923-9-B

X-ON Electronics

Largest Supplier of Electrical and Electronic Components

Click to view similar products for [Terminals](#) category:

Click to view products by [3M](#) manufacturer:

Other Similar products are found below :

[00-054007-01074-6](#) [00-054007-70206-1](#) [00-054007-70210-8](#) [00-054007-70217-7](#) [00-054007-70226-9](#) [00-054007-70228-3](#) [00-054007-70248-1](#) [00-054007-70256-6](#) [00-054007-70301-3](#) [00-054007-70316-7](#) [00-054007-49560-4](#) [00-054007-70209-2](#) [00-054007-70225-2](#) [00-054007-70227-6](#) [00-054007-70231-3](#) [00-054007-70241-2](#) [00-054007-70242-9](#) [00-054007-70244-3](#) [00-054007-70246-7](#) [00-054007-70263-4](#) [00-054007-70288-7](#) [00-054007-70290-0](#) [00-054007-70300-6](#) [00-054007-70304-4](#) [01-2065-1-0216](#) [01-2900-1-04412](#) [00581P0075](#) [600TS-10](#) [60205-1](#) [604200-1](#) [605601-1](#) [60598-1-CUT-TAPE](#) [61314-6-C](#) [61810-3](#) [61-S](#) [62149-1](#) [626-0194](#) [62-NBM-A](#) [63-S](#) [640179-1](#) [M55155/059I03](#) [M55155/079C01](#) [M55155/099B03](#) [M55155/099H02](#) [M55155/109H01](#) [M55155/109H02](#) [M55155/12XH05](#) [M55155/16XH02](#) [M55155/29-5S](#) [M55155/29XJ08](#)