



Science.  
Applied to Life.™

# 3M Packaging Solutions Guide

Right tapes.  
Right system.  
Right partner.

3M Closure and Masking Systems Division  
April 2019

# At 3M, we never forget our success was sealed by a roll of tape.

A single inventive way of solving a customer's problem more than 86 years ago led to a breakthrough that became known as "Scotch® Tape"; an invention that changed the world. Today, the curious minds at 3M continue to maintain the legacy of the original Scotch® Tape by meeting customer needs everyday and never compromising on performance.

Reliable performance proven over time has formed a bond of trust with Scotch® Tape. This is why it remains the number one brand for packaging, bundling, reinforcing solutions and more. At 3M, we stake our reputation on delivering the very best, most reliable tapes every day so you can trust Scotch® Tape to protect your reputation, as well.

You can double down on dependability by combining Scotch® Box Sealing Tapes with 3M-Matic™ Case Sealers. With nearly a half-century of experience in building case sealing equipment, 3M delivers the "total package" in packaging systems.

In a world where so many unexpected events can impact your results, Scotch® Tapes and 3M packaging solutions have got you covered — with dependable, high quality products and systems to meet your ever-changing requirements.

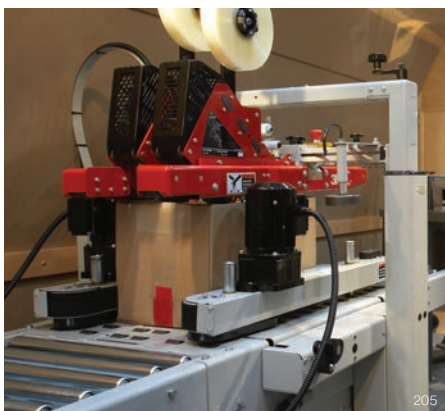

# Right tapes. Right system. Right partner.

## 3M Packaging Solutions



### Packaging Equipment and Dispensers

3M-Matic™ Case Sealers Selection Overview .....	6-7
3M-Matic™ Adjustable Case Sealers .....	8-9
3M-Matic™ Random Case Sealers .....	10
3M™ AccuGlide™ Taping Head Technology .....	11
Customized 3M-Matic™ Equipment .....	11
Non-RSC Closure Solutions.....	12
3M-Matic™ Case Sealers Replacement Parts and Accessories .....	13
Scotch® and Tartan™ Manual Tape Dispensers.....	14-16
3M Systems Tape Agreement .....	17



### Box Sealing Tapes

Scotch® and Tartan™ Box Sealing Tapes.....	21
Scotch® Recycled Corrugate Tapes.....	22
Scotch® Custom Printed Box Sealing Tapes.....	23
Scotch® Cold Temperature Tape.....	24
Scotch® Security Tapes .....	24-25
Scotch® Specialty Box Sealing Tapes .....	25
Light Duty Packaging Tapes .....	26-27



### High Strength Tapes

High Strength Tapes .....	29
High Strength Filament Tapes.....	30-31
Tensitized Polypropylene Tapes .....	32
Scotch® Reinforced Strapping Tapes.....	33
Scotch® Stretchable Tapes .....	34

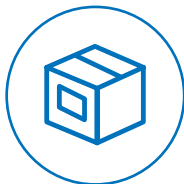

### Custom Packing Solutions

3M™ Carry Handles.....	36-37
Scotch® Multipack Tapes.....	38
Bag Sealing Tapes .....	39
3M™ Tape Pads .....	39
Scotch® Bag Conveying Tape .....	40
3M™ Hang Tabs.....	40
Scotch® Pouch Tapes.....	41
Label Protection Tapes .....	41
3M™ Packing List Envelopes .....	42
Remote Sensing Tapes .....	43
Scotch® Tear Strip Tapes .....	44

<b>Glossary</b> .....	45-46
-----------------------	-------

<b>Numerical Index</b> .....	47
------------------------------	----

<b>Product Name Index</b> .....	48-49
---------------------------------	-------

**Combi**  
Packaging Systems LLC

**3M-Matic**  
Case Sealing Systems

## ERECTING & PACKING

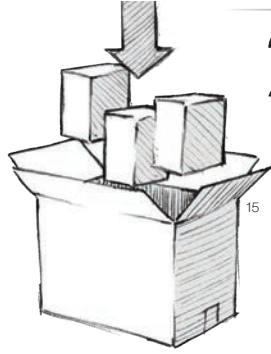

Case erectors  
Ergo packs

Throughput & speed

3M™ AccuGlide™ Tape  
Head Technology

**3M-Matic**  
Case Sealing Systems

Consistency  
Security  
Protection

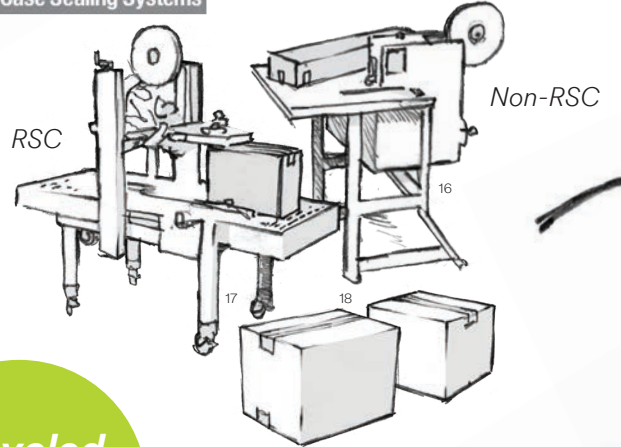

## SEALING

Semi-automatic  
Hand applied  
Bag sealing



**Scotch**

Recycled  
corrugate?  
No problem!

**Scotch**

Protection  
Control  
Security

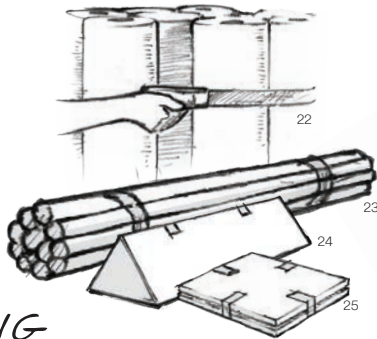

## BUNDLING

### L-CLIP CLOSURE

## PACKING STATIONS

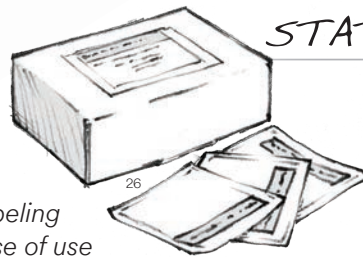

Labeling  
Ease of use

Document attachment  
Label protection  
Patching

**Tech support**  
Before & after  
the sale

**Scotch** **3M**

# The Total Package

Pack it. Close it. Move it. Sell it. Use it.

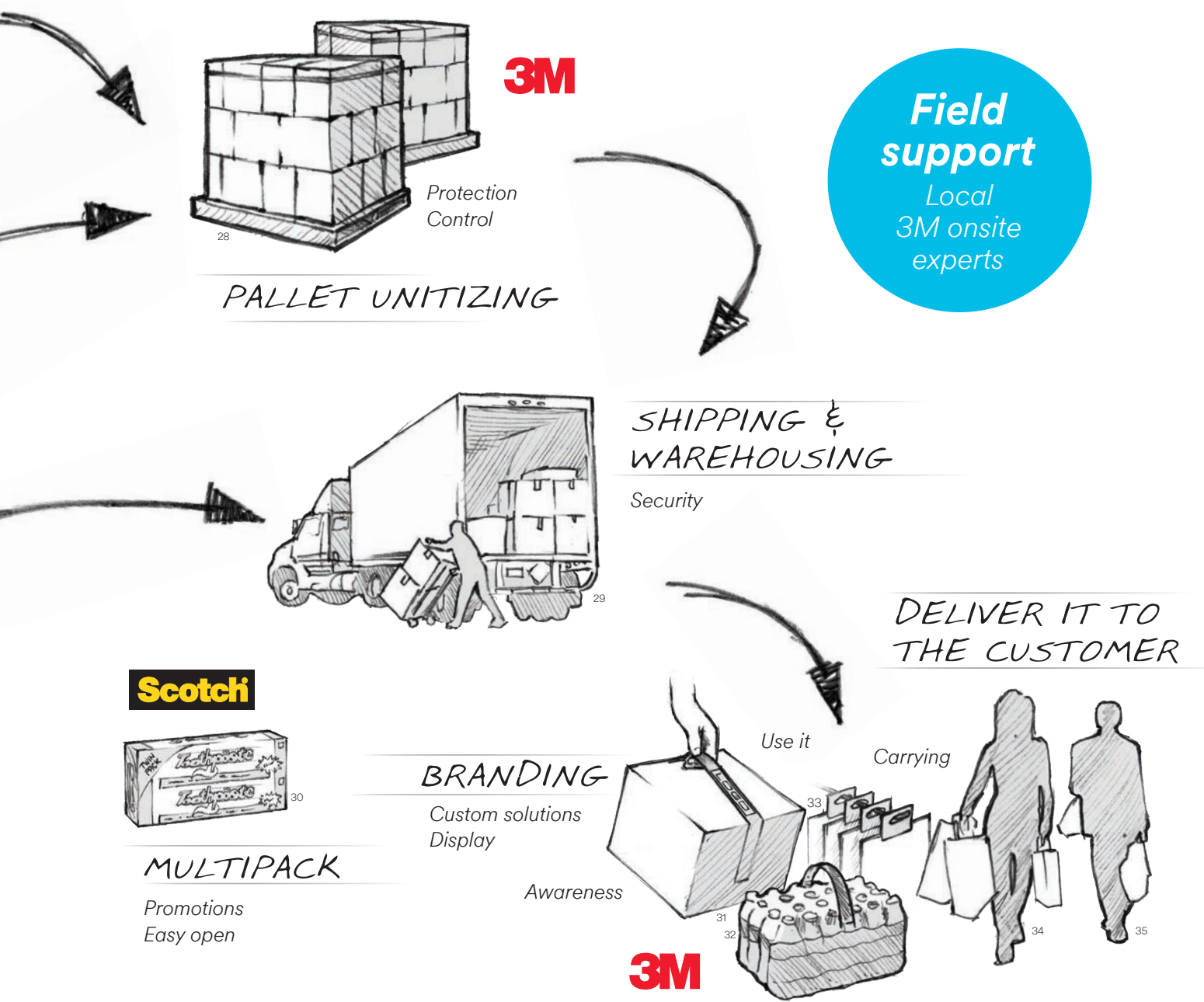

**Field support**  
Local  
3M onsite  
experts



# Packaging Equipment & Dispensers

How do you get your packages securely sealed, out the door and into the hands of your customers in the fastest, most efficient manner? It starts with 3M-Matic™ Case Sealers. For 50 years, packaging facilities everywhere have relied on these productivity-enhancing solutions for consistent, efficient case sealing, day after day.



**3M-Matic™**  
Case Sealers  
ANNIVERSARY CELEBRATION  
Consistent. Reliable. Tough.  
**3M**

**3M-Matic™**  
Case Sealing Systems

## 3M-Matic™ Case Sealer

### Things to Consider When Selecting a Case Sealer

1

**Do you pre-form your boxes?  
What style box do you use?**

- RSC (Regular Slotted Carton)
- FPF (Five Panel Fold)
- Full overlap

3

**What closure method do you use?**

- RGT (Reinforced Gum Tape)
- Pressure-sensitive box sealing tape
- Glue
- Staples

2

**How many boxes do you  
seal per day?**

4

**Do you seal your boxes  
in uniform or random  
production runs?**

# 3M-Matic™ Case Sealers Selection Overview



38

For Sealing Uniform Size Boxes

## Manually Adjustable, Semi-Automatic Affordable for Low Volume



**a20**

Up to 30 cs/min  
Up to 65 lbs  
Bottom belt drive

40



**a80\***

Up to 30 cs/min  
Up to 65 lbs  
Side belt drives

41

## Manually Adjustable, Semi-Automatic



**8000af**

Up to 40 cs/min  
Up to 85 lbs  
Side belt drives

210

\*Available with 3 inch taping head.

## Manually Adjustable, Semi-Automatic Affordable for Low Volume



**200a\***

Up to 40 cs/min  
Up to 85 lbs  
Bottom belt drive

211



**800ab**

Narrow cases  
Bottom only taping  
Up to 40 cs/min  
Up to 85 lbs  
Side belt drives

44



**800asb**

Small cases  
Up to 28 cs/min  
Up to 85 lbs  
Side belt drives

194



**7000a Pro**

Up to 40 cs/min  
Up to 85 lbs  
Top/bottom belt drives

195



**8000a**

Up to 40 cs/min  
Up to 85 lbs  
Side belt drives

191

\*Available with 3 inch taping head.





# 3M-Matic™ Case Sealers Selection Overview



39

For Sealing Various Size Boxes

## Self-Adjusting, Semi-Automatic



**800r\*** 49  
Up to 20 cs/min  
Up to 85 lbs  
Side belt drives



**800rks†** 50  
Up to 10 cs/min  
Up to 200 lbs  
Top/bottom side belt drives



**7000r Pro\*** 192  
Up to 24 cs/min  
Up to 85 lbs  
Top/bottom belt drives



**7000r HS Pro\*** 209  
Up to 28 cs/min  
Up to 60 lbs  
Top/bottom belt drives

\*Available with 3 inch taping head.

†Comes standard with 3 inch taping head.

## Non-RSC Box



**S867** 52  
3M-Matic™ L-Clip Applicator S867 is a semi-automatic unit that applies 4.5 inch L-Clips of Scotch® Filament Tapes and Scotch® Box Sealing Tapes at up to 50 clips/min.



**S867 II** 64  
3M-Matic™ Dual L-Clip Applicator S867 II applies two 4.5 inch L-Clips of Scotch® Filament or Reinforced Strapping Tape on the same edge at up to 50 clips/min.

## Self-Adjusting, Fully-Automatic Flap Folding



**800rf\*** 51  
Up to 10 cs/min  
Up to 65 lbs  
Side belt drives

\*Available with 3 inch taping head.

**3M-Matic Helpline: 1-800-328-1390**

When you have a question, simply call the toll-free helpline, open to take your calls Monday through Friday, 8:00am to 4:30pm Eastern Standard Time. Messages will be taken 24 hours a day for next working day response.

### Belt Drive Key

2 = Bottom belt drives  
7 = Top and bottom belt drives  
8 = Side belt drives

### Box Type

a = Adjustable, for batch runs  
r = Random, for mixed runs

### Additional Capability

b = Bottom only  
f = Flap folding  
ks = King size  
sb = Small box

# 3M-Matic™ Adjustable Case Sealers



## Gain productivity with quick height and width adjustments.

With quick manual adjustment, these rugged units reliably and accurately seal runs of the same size cartons for a variety of markets: food and beverage, medical devices, pharmaceutical, electronics, retail, manufacturing and distribution centers to name a few.



**3M-Matic™ Adjustable Case Sealer a20** is an adjustable bottom belt drive case sealer to dependably seal uniform cases at up to 30 per minute.



**3M-Matic™ Case Sealer 200a** is an adjustable bottom belt drive case sealer to dependably seal uniform cases at up to 40 per minute.



**3M-Matic™ Adjustable Case Sealer 7000a Pro** is an adjustable top and bottom belt drive to dependably seal uniform cases at up to 40 per minute.



**3M-Matic™ Adjustable Case Sealer 700a-s** has advanced features to seal uniform cases at up to 30 per minute. Dual masts with dual lead screws for stability and uniform height adjustments. Adjustable top and bottom belt drive system for reliable conveyance of heavier or tall/light boxes. Compression rollers position each box for precise tape sealing. Stainless construction for corrosive environments.

## Bottom Belt Drive Systems

Machine	Drive System	Box Size Capacity (inches)						Power Requirements		Operating Rate (cs/min)	Belt-Drive Speed (ft/min (m/s))	Taping Head	Comments
		Minimum			Maximum			Electrical	Air				
		L	W	H	L	W	H						
a20	Bottom	6.0	6.5	4.25	N/L	21.5	21.5	115VAC 60Hz 2.8A 360W	No Air	Up to 30	78 (0,4)	2" 3M™ AccuGlide™ 2+	Entry Level
a20-s				[3.5]									Stainless Steel
200a	Bottom	6.0	6.5	4.5	N/L	21.5	24.5	115VAC 60Hz 1.9A 220W	No Air	Up to 40	100 (0,5)	2" 3M™ AccuGlide™ 3 3" 3M™ AccuGlide™ 3	Semi-Automatic Adjustable
200a3			[3.75]										

Standard size capabilities are listed above. If additional sizes can be met, they are indicated by [Taping Head] or [Machine Configuration]. Changing the taping head or machine configuration will allow for enhanced box height range indicated in the chart above. Please refer to the Instructions and Parts List or 3M representative for more detail.

## Top and Bottom Belt Drive Systems

Machine	Drive System	Box Size Capacity (inches)						Power Requirements		Operating Rate (cs/min)	Belt-Drive Speed (ft/min (m/s))	Taping Head	Comments
		Minimum			Maximum			Electrical	Air				
		L	W	H	L	W	H						
700a-s	Top and Bottom	6.0	6.0	4.75	N/L	21.5	24.5	115VAC 60Hz 3.8A 440W	No Air	Up to 30	78 (0,4)	2" 3M™ AccuGlide™ 2+ Stainless Steel	For Corrosive Environment
7000a Pro	Top and Bottom	6.0	6.5	4.75	N/L	26.5	28.0	115VAC 60Hz 3.8A 440W	No Air	Up to 40	100 (0,5)	2" 3M™ AccuGlide™ 3 3" 3M™ AccuGlide™ 3	Extended size capabilities are possible, please contact 3M
7000a3 Pro													

Standard size capabilities are listed above. If additional sizes can be met, they are indicated by [Taping Head] or [Machine Configuration]. Changing the taping head or machine configuration will allow for enhanced box height range indicated in the chart above. Please refer to the Instructions and Parts List or 3M representative for more detail.



# 3M-Matic™ Adjustable Case Sealers



**a80**  
**3M-Matic™ Adjustable Case Sealer a80** is an adjustable side belt drive case sealer that dependably seals uniform size cases.

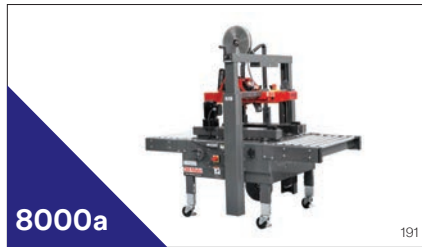

**8000a**  
**3M-Matic™ Side Belt Adjustable Case Sealer 8000a** is an adjustable side belt drive case sealer. Seals up to 40 cases per minute, using tape widths from 36mm to 48mm, and also 72mm tape.



**800asb**  
**3M-Matic™ Case Sealer 800asb** is an adjustable side belt drive case sealer. Seals up to 28 cases per minute, using tape width of 36mm.

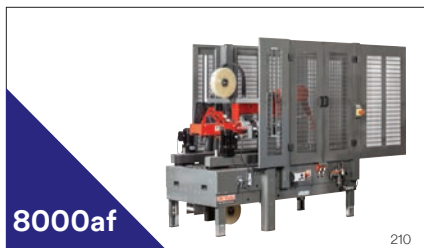

**8000af**  
**3M-Matic™ Case Sealer 8000af** is an automatic flap folding machine that seals both the top and bottom of a box without an operator.



**800ab**  
**3M-Matic™ Case Sealer 800ab** is an adjustable side belt drive case sealer. Applies bottom seal only at rates up to 40 cases per minute, using tape widths from 36mm to 48mm, and also 72mm tape.



**3M-Matic™ T-table Attachment** is a 6" x 44" t-table attachment for use with 3M-Matic™ Case Sealers a80 and a80-3.

## Side Belt Drive Systems

Machine	Drive System	Box Size Capacity (inches)						Power Requirements		Operating Rate (cs/min)	Belt-Drive Speed ft/min (m/s)	Taping Head	Comments
		Minimum			Maximum			Electrical	Air				
		L	W	H	L	W	H						
a80	Side	6.0	4.75	4.5	N/L	21.5	21.5	115VAC 60Hz 3.8A 440W	No Air	Up to 30	78 (0,4)	2" 3M™ AccuGlide™ 2+	Entry Level
a80-3			5.75									3" 3M™ AccuGlide™ 2+	
a80b	Side	6.0	4.75	3.5	N/L	21.5	N/L	115VAC 60Hz 3.8A 440W	No Air	Up to 30	78 (0,4)	2" 3M™ AccuGlide™ 2+	Entry Level Bottom Taping Only
a80b-3			5.75									3" 3M™ AccuGlide™ 2+	
8000a	Side	6.0	4.5	4.75	N/L	21.5	28.5	115VAC 60Hz 3.8A 440W	No Air	Up to 40	100 (0,5)	2" 3M™ AccuGlide™ 3	Extended size capabilities are possible, please contact 3M
8000a3			5.5	4.75			28.5					3" 3M™ AccuGlide™ 3	
800asb	Side	6.0	3.9	2.75	N/L	21.5	22.25	115VAC 60Hz 3.8A 440W	No Air	Up to 28	57 (0,3)	1.5" 3M™ AccuGlide™ II	Small Box
800ab	Side	6.0	5.5		N/L	21.5	N/L	115VAC 60Hz 3.8A 440W	No Air	Up to 40	100 (0,5)	2" 3M™ AccuGlide™ 3	Bottom Taping Only
800ab3												3" 3M™ AccuGlide™ 3	
8000af	Side	6.0	4.75	4.5	30	21.5	28.5	115VAC 60Hz 3.8A 440W	2.5 SCFM @ 85 PSIG	Up to 40	100 (0,5)	2" 3M™ AccuGlide™ 3	Flap-Folding
8000af3			5.75									3" 3M™ AccuGlide™ 3	
a80-t	Side	6.0	4.75	4.5	N/L	21.5	21.5	115VAC 60Hz 3.8A 440W	No Air	Up to 30	78 (0,4)	2" 3M™ AccuGlide™ 2+	Entry Level Pack Station

Standard size capabilities are listed above. If additional sizes can be met, they are indicated by [Taping Head] or [Machine Configuration]. Changing the taping head or machine configuration will allow for enhanced box height range indicated in the chart above. Please refer to the Instructions and Parts List or 3M representative for more detail.

# 3M-Matic™ Random Case Sealers



## Gain productivity with automatic height and width adjustments.

Adjusting automatically, these rugged units reliably and accurately seal runs of random size cartons for a variety of markets: food and beverage, medical devices, pharmaceuticals, electronics, retail, manufacturing and distribution centers. The 3M™ AccuGlide™ 2+ and 3 Taping Heads securely apply tape with low impact to protect even lightweight cases.



**7000r Pro**  
**3M-Matic™ Random Case Sealer 7000r Pro** is a semi-automatic random case sealer that automatically adjusts for case height and width and is capable of sealing 24 cases per minute, using tape widths from 36mm to 48mm wide.

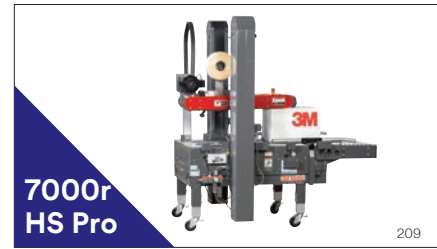

**7000r HS Pro**  
**3M-Matic™ Random Case Sealer 7000r High Speed Pro** is a random size case sealer designed to automatically adjust to a variety of box sizes. It can seal up to 28 different case sizes per minute.



**800r**  
**3M-Matic™ Case Sealer 800r** is a semi-automatic random case sealer automatically adjusts for case height and width. Top and bottom seal at rates up to 20 cases per minute, using tape widths from 36mm to 48mm wide.



**800rks**  
**3M-Matic™ Case Sealer 800rks** is a random king size case sealer that automatically adjusts for case height and width and is capable of sealing up to 10 cases per minute, using tape widths from 48mm to 72mm wide.



**800rfs**  
**3M-Matic™ Case Sealer 800rf Type 40800** is a fully automatic random size case sealer that automatically adjusts for various case sizes and folds the top minor and major flaps up to 10 cases per minute. Using tape widths from 36mm to 48mm tape widths.

## Top and Bottom Belt Drive Systems

Machine	Drive System	Box Size Capacity (inches)						Power Requirements		Operating Rate (cs/min)	Belt-Drive Speed ft/min (m/s)	Taping Head	Comments
		Minimum			Maximum			Electrical	Air				
		L	W	H	L	W	H						
<b>7000r Pro</b>	Top and Bottom	6.0	6.5	4.5	N/L	26.5	26.0	115VAC 60Hz 3.8A 440W	3.75 SCFM @ 85 PSIG	Up to 24	100 (0,5)	2" 3M™ AccuGlide™ 3	Extended size capabilities are possible, please contact 3M
<b>7000r3 Pro</b>												3" 3M™ AccuGlide™ 3	
<b>7000r HS Pro</b>	Top and Bottom	7.0	7.0	3.5	N/L	26.0	27.0	115VAC 60Hz 9.5A 1140W	15 SCFM @ 90 PSIG	Up to 28	150 (0,76)	2" 3M™ AccuGlide™ 4	
<b>7000r3 HS Pro</b>				2.7*								38.13*	

\*Requires special setup.

## Side Belt Drive Systems

Machine	Drive System	Box Size Capacity (inches)						Power Requirements		Operating Rate (cs/min)	Belt-Drive Speed ft/min (m/s)	Taping Head	Comments
		Minimum			Maximum			Electrical	Air				
		L	W	H	L	W	H						
<b>800r</b>	Side	8.0	4.0	5.0	N/L	20.0	21.0 [25,25]	115VAC 60Hz 3.8A 440W	3.75 SCFM @ 85 PSIG	Up to 20	100 (0,5)	2" 3M™ AccuGlide™ 3	Semi-Automatic Random
<b>800r3</b>												3" 3M™ AccuGlide™ 3	
<b>800rks</b>	Side	15.0	6.0	12.0	N/L	30.0	50.0	208/240VAC 3Ph 60Hz 6.6A 1500W	6.25 SCFM @ 85 PSIG	Up to 10	78 (0,4)	3" 3M™ AccuGlide™ 2+	Random King Size
<b>800rf</b>	Side	8.0	5.5	6.0	24.0	20.0	20.0	208/240VAC 3Ph 60Hz 5.5A 1300W	7.0 SCFM @ 75 PSIG	Up to 10	100 (0,5)	2" 3M™ AccuGlide™ 3	Fully-Automatic
<b>800rf3</b>												3" 3M™ AccuGlide™ 3	

Standard size capabilities are listed above. If additional sizes can be met, they are indicated by [Taping Head] or [Machine Configuration]. Changing the taping head or machine configuration will allow for enhanced box height range indicated in the chart above. Please refer to the Instructions and Parts List or 3M representative for more detail.



# 3M™ AccuGlide™ Taping Head Technology

## 3M taping heads for easy and accurate case sealing.

3M™ AccuGlide™ Taping Heads are a curvilinear design that applies tape securely with low impact that helps protect even lightweight cartons and contents. Since the combination of box sealing tape and taping head determines carton closure performance, 3M is continually improving both to meet your requirements for productivity and reliability.



### 3M™ AccuGlide™ 4

Narrow profile taping head designed to fit any case sealing system. Great for higher speed packaging lines.



### 3M™ AccuGlide™ 3

Raising the speed limit to 100 ft. per minute for easy, consistent and accurate case sealing.



### 3M™ AccuGlide™ 2+

Speeds up to 80 ft. per minute. Stainless steel option available.



### 3M™ AccuGlide™ NPH

Designed for case sealers with narrow taping head cavity. Applies tape at up to 100 ft. per minute.



### 3M™ AccuGlide™ LHB

A low height box taping head that exerts minimum force on case and utilizes shorter tape legs.



### 3M™ AccuGlide™ HST

Heads available to apply 48mm and 72mm wide tape at case speeds of up to 150 ft. per minute. Unique precision shaft and ball bushing slide ensure precise application.

## Customized 3M-Matic™ Equipment

### Built around your product needs.

A leading player in case sealing equipment, 3M realizes it's not one size fits all. We have a unique capability to take an existing 3M-Matic™ Case Sealer and customize it to securely seal your unique cartons. Some of our capabilities include width and height modifications, accommodating lighter or heavy weight boxes, and integrating unique tape set ups.



Side Taping

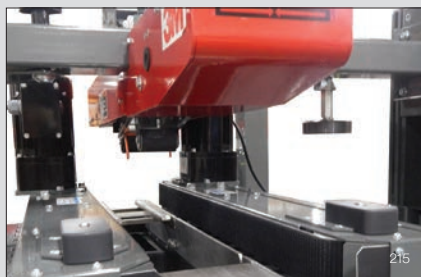

Box Lift for Low Height Cases



Wide Roll Taping

# Non-RSC Closure Solutions

**A range of solutions can help increase throughput while decreasing packaging costs.**

- Solutions for start-ups
- Automation for large companies

## 3M-Matic™ L-Clip Applicator S867 and S867II

To save cost and time, apply pre-fed 4.5-inch L-Clips of Scotch® Filament or Reinforced Strapping Tapes at up to 50 clips per minute to five panel fold, full overlap, telescoping, tuck fold and other non-standard packages. Dual head applies two clips simultaneously as close as 8 inches apart.



3M-Matic™ Dual L-Clip Applicator S867II

64



Scotch® Filament Tape Box Sealer S634

69



3M-Matic™ L-Clip Applicator S867 with optional U-Clip adapter.

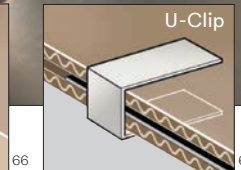

66

65

67

## Table Top L-Clip Applicators

Features	Box Sealer S634
Tape Type(s)	Filament Tape Light Duty Packaging Tape, Upper Scotch® Packaging Tape
Can L-Clip These Package Types	Corrugate
Applied Tape Length	4.5 inch (114mm)
Tape Width Options	0.375–1.5 inch (9.5–36mm)
Cutting Method	Serrated blade cuts tape as box passes L-Clip application mechanism

## Great L-Clip Closure Solution for Non-RSC Box Styles

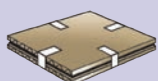

U-Clip Package

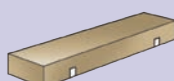

Telescoping Box

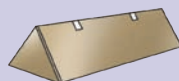

Custom Box

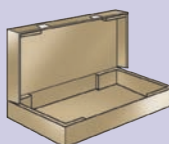

One Piece Box



F.O.L.

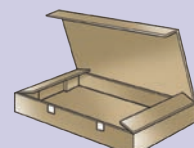

Five Panel Box

68



# 3M-Matic™ Case Sealers Replacement Parts and Accessories

## Genuine 3M Parts to maintain optimal performance of 3M-Matic™ Case Sealers.

Engineered for rugged duty with steel construction and epoxy coated surfaces, 3M-Matic™ Case Sealers may have parts that wear and need occasional replacement. 3M maintains stock of a full range of replacement parts from typical wear parts such as blades, belts, and springs to safety labels to bushings and cylinders. With over 5,000 stocked SKUs, replacement parts are available for prompt delivery to your location whether you are doing preventive maintenance or rebuilding a 3M-Matic™ Case Sealer after years of service.

Regular preventive maintenance of your equipment and quality parts are keys to performance of both newer case sealers or models that have been running for 30 years.



**For replacement parts contact CSPD at Combi:  
1-800-344-9883**

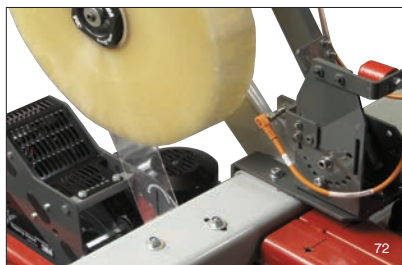

### Application Monitor

With top and bottom sensors, the case sealer mounted programmable logic controller alerts the operator when tape is not applied to the box or not cut, or when tape supply is low on the roll.



### Low Tape Indicator Light Kit

An option for 3M-Matic™ Case Sealers. Indicates when tape is getting low.



### 3-Flap Folder

For increased productivity, easily attached flap folder assists operator in folding the minor (front) and two major (side) flaps of RSCs before taping.



### Infeed/Exit Conveyor

Ball bearing steel rollers in a steel frame bolts to the 3M-Matic™ Case Sealer to provide a smooth transition in existing conveyor lines. Provides pack area surface at infeed. Available also in stainless steel.



### Box Hold Down Attachment

Holds RSCs on the optional infeed conveyor to free the operator's hands for case filling.



### Locking/Swivel Casters

When packaging operations need to be reconfigured or moved, 3M-Matic™ Case Sealers roll to the job on these heavy duty casters. Toe-operated lever locks case sealer in place.

# Scotch® and Tartan™ Manual Tape Dispensers

## Scotch® Box Sealing Tape Dispenser HR80/HR83

Portable, lightweight, easy to operate, hand-held dispenser with a retractable blade.



## Scotch® Low Noise Box Sealing Tape Dispenser H150/H153

A hand-held, roll-on, pistol-grip dispenser designed to reduce the noise of tape unwind.



## Tartan™ Box Sealing Hand Dispenser HR933

Tape dispenser with a retractable blade.

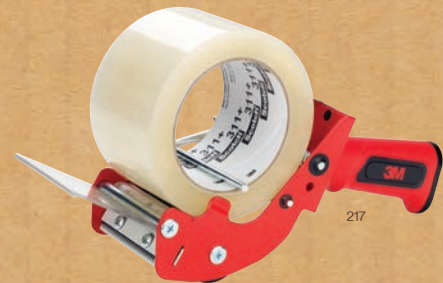

## Scotch® Heavy-Duty Dispensers

Manual heavy-duty dispensers for use with 3M™ Narrow Width Film Tapes.

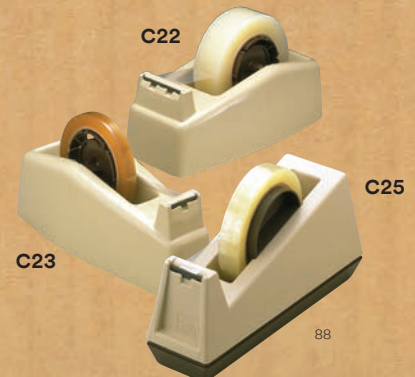





## Scotch® Box Sealing Tape Dispensers

Hand-held dispensers for use with specially formulated Scotch® Box Sealing Tapes.



## Scotch® Filament Tape Dispensers

Hand-held dispensers for use with Scotch® High Strength Filament Tapes.



## Scotch® Bag Sealers

Applies tape in an adhesive-to-adhesive flag seal.

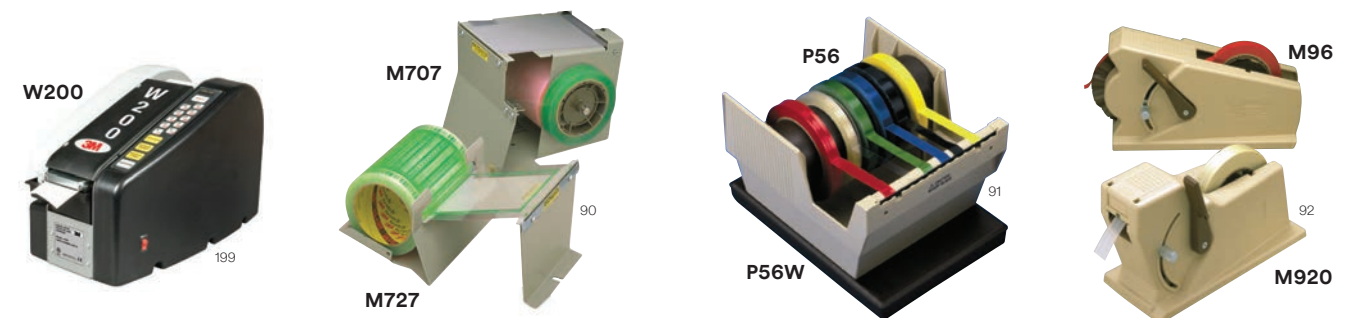

### 3M™ Electric Water Activated Tape Dispenser

Dispenser has a heated water reservoir that speeds tape activation. Dispenses a pre-set length of water-activated tape at the push of a button. (Manual version also available.)

### Scotch® Label Protection Dispensers

Tabletop and portable dispensers designed specifically for 3M™ Label Protection and Pouch Tapes.

### Scotch® Multi-Roll Dispenser

Dispenser for pull and tear of up to 6 inches total width of tapes. P56W offers weighted base. (P52/P52W also available for up to 2" total width tape.)

### Scotch® Definite Length Dispensers

Dispensers that deliver a uniform length of 3M™ Narrow Width Tape and Scotch® Filament Tapes every time quickly and easily. (M82 and M900 are also available for wider tape dispensing.)

# Scotch® and Tartan™ Manual Tape Dispensers

## Easy dispensing for manufacturing, office, commercial and retail jobs.

All Scotch® and Tartan™ Manual Tape Dispensers for box sealing tapes, filament tapes, film tapes, label protection tapes and pouch tapes are application-designed to meet the needs of the customer. Select from a variety of hand-held and heavy duty pull-and-tear table top dispensers.

Product	Product Description	Max Tape Width
<b>Hand-Held Box Sealing Tape Dispensers</b>		
H122	Durable plastic dispenser with built-in brake for precise seals	48mm
H123	Lightweight, compact metal tape dispenser	72mm
H128	Heavy-duty durable metal tape dispenser	48mm
H129	Quick and easy one hand method to apply, cut, and buff the tape closures	48mm
H150	Tape dispenser designed to reduce the noise of tape unwind during application	48mm
H153	Tape dispenser designed to reduce the noise of tape unwind during application	72mm
H180	Portable and easy to operate pistol grip dispenser	48mm
H183	Portable and easy to operate pistol grip dispenser	72mm
H190	Pistol grip dispenser features pull apart design	48mm
H192	Ergonomical tape dispenser with hand brake	48mm
H320	Ultra-light, economical, plastic tape dispenser	48mm
HB902	Economical, compact, and lightweight tape dispenser	48mm
HB903	Economical pistol grip tape dispenser	48mm
HR80	Portable, lightweight, easy to operate, dispenser with a retractable blade	48mm
HR83	Portable, lightweight, easy to operate, dispenser with a retractable blade	72mm
HR933	Tape dispenser with a retractable blade	72mm
<b>Hand-Held Filament Tape Dispensers</b>		
H10	Durable, lightweight plastic tape dispenser	24mm
H12	Portable, plastic dispenser features a hand brake to add tension to the tape roll	24mm
H121	Durable, metal dispenser allows operator to add tension for a tighter tape application	24mm
H128	Heavy-duty, metal dispenser commonly used to dispense tapes 8959 and 890	48mm
H130	Portable, plastic dispenser features a hand brake to add tension to the tape roll	18mm
H131	Quick and easy one hand method to apply, cut, and buff the tape closures	18mm
H133	Quick and easy one hand method to apply, cut, and buff the tape closures	18mm
HB901	Economical and portable tape dispenser	24mm
<b>Table Top Dispensers</b>		
C22	Weighted dispenser for easy pull and cut tape dispensing	2 in
C23	Weighted dispenser for easy pull and cut tape dispensing	1 in
C25	Weighted dispenser for easy pull and cut tape dispensing	1 in
HB900	Weighted, slip-proof base for quick and easy one-handed operation	1 in
M82	Definite length dispenser handles multiple rolls of tape commonly dispensed with filament and light duty tapes	96mm
M96	Definite length dispenser — dispenses tape in lengths of 3/4 inch to 5 inch per stroke	1 in
M900	Durable, metal construction dispenses a uniform length of packaging tape from 1-1/2 inch to 16 inch	3 in
M920	Definite length dispenser — dispenses tape in lengths of 1/2 inch to 4 inch per stroke	1 in
P52	Mainline tabletop manual pull and cut dispenser with multiple roll capacity	2 in
P52W	Mainline tabletop manual pull and cut dispenser with multiple roll capacity (comes with weighted base)	2 in
P56	Mainline tabletop manual pull and cut dispenser with multiple roll capacity	6 in
P56W	Mainline tabletop manual pull and cut dispenser with multiple roll capacity (comes with weighted base)	6 in
P448	Metal dispenser that handles multiple rolls for easy dispensing	8 in
S634	Semi-automatically applies L-Clip of tape to a box using filament or light duty tapes	18mm
W100	Manually dispenses pre-set length of water-activated tapes	3 in
W200	Electronic dispenser — dispenses a pre-set length of water-activated tape at the push of a button	3 in
<b>Specialty Tape Dispensers</b>		
H38	Durable dispenser specially designed for stretch tapes 8884 and 8886	36mm
M707	Heavy duty metal dispenser with auxiliary holder and cutter for 3/4-inch rolls of tape — commonly used with tapes 821 and 823	4 in
M727	Metal construction provides easy dispensing of pouch tapes 824, 827 and 829	5 in
M797	Metal construction provides easy dispensing of pouch tape 827	6 in
P400	Bag sealer — applies tape in an adhesive-to-adhesive — flag seal (includes bag trimmer)	3/4 in



# 3M Systems Tape Agreement

- Save on the overall cost of your case sealing equipment
- Accelerate your packaging equipment Return on Investment
- Receive valuable parts and accessories at no charge
- Help increase productivity and uptime
- Choose options that best fit your needs

**Save money**  
Help accelerate your ROI



The more tape you purchase, the greater your savings!



**BUY a new 3M-Matic™ Case Sealer plus Scotch® Box Sealing Tape and GET a cash rebate or accessories at no additional charge!**

## Earn Cash Rebates\*

- ☛ Earn cash rebates when you purchase a new 3M-Matic™ Case Sealer or Combi Packaging Systems equipment and purchase qualifying amounts of Scotch® Box Sealing Tape in accordance with the terms of the program.

## Add Credits Towards a New Case Sealer\*\*

- ☑ **Spare parts kits or parts vouchers:**  
Earn free spare parts for your 3M-Matic™ Case Sealer when you purchase qualifying amounts of Scotch® Box Sealing Tape
- ☑ **3M™ AccuGlide™ Taping Heads:**  
Earn free 3M™ AccuGlide™ Taping Heads for your 3M-Matic™ Case Sealer when you purchase qualifying amounts of Scotch® Box Sealing Tape
- ☑ **Scotch® Manual Tape Dispenser**  
Earn a free dispenser when you purchase qualifying amounts of Scotch® Box Sealing Tape



**Sign a second 3M Systems Tape Agreement, get another taping accessory at no additional charge.†**  
3M tape dispensers available with qualifying purchases.

\*Rebate check is paid directly from 3M to customer after completing purchase of 3M-Matic™ Case Sealing Equipment and qualifying tape products. Fixed dollar amount of rebate is determined by the model. Other conditions may apply. Contact your 3M Representative for more details.

\*\*3M™ AccuGlide™ Taping Heads, Spare Parts Kits and Hand Dispensers are shipped up front to customer upon signing new tape purchase agreement. Parts Vouchers can be used as needed during the agreement term.

†Purchase requirements for initial Systems Tape Agreement must be satisfied in order to enter into a second agreement.



# Box Sealing Tapes

Delivering quality with tapes that keep production lines moving with less interruption and ensure packages are sealed on arrival.



# The full job of a package is containment, protection and communication.

## Technology that really delivers.

- Seal cartons reliably without the mess, dwell time and equipment maintenance of hot melt adhesive
- Two choices of pressure sensitive adhesive, each with a different combination of properties
- Backing choices for specific performance properties

3M eliminates 99% of organic solvents in production of Scotch® Box Sealing Tape.

Our Scotch® Recycled Corrugate Tape 3073 is made with an adhesive that contains over 10% bio-based content. All recycled corrugate tapes use recycled materials in the core to help with your sustainability goals.

Visit [3M.com/sustainability](http://3M.com/sustainability) for more goals.



**Caring for the environment now and for the future.**

## Scotch® Box Sealing Tapes solve common package sealing problems:



Problem: Tabbing

**Solution:** Easy unwind and high initial adhesion of Scotch® Box Sealing Tapes reduce tabbing downtime and rework.



Problem: Tape popping

**Solution:** Initial adhesion and holding power of Scotch® Box Sealing Tapes ensure a secure sealing throughout a supply chain.

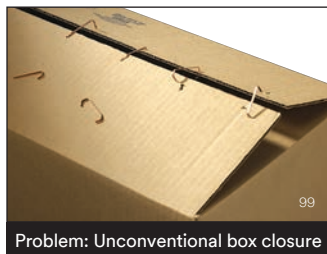

Problem: Unconventional box closure

**Solution:** Scotch® Box Sealing Tapes close securely without the holes, waste, appearance, sharp points and disposal of staples.



Problem: Temperature/Humidity

**Solution:** Scotch® Box Sealing Tapes resist moisture encountered in storage and shipping through the supply chain.

## Tape Backing and Adhesive Selection Guide

<b>Step 1</b> Select Tape Backing	<b>Polyester</b>	<ul style="list-style-type: none"> <li>• Strongest backing</li> <li>• Excellent abrasion resistance</li> <li>• Moisture and chemical resistance</li> </ul>	<ul style="list-style-type: none"> <li>• Highest temperature resistance</li> <li>• Transparency</li> </ul>
	<b>Polypropylene</b>	<ul style="list-style-type: none"> <li>• Strong backing</li> <li>• Good abrasion resistance</li> <li>• Good conformability</li> </ul>	<ul style="list-style-type: none"> <li>• Most economical</li> <li>• Transparency</li> </ul>
<b>Step 2</b> Select Tape Adhesive	<b>Synthetic Rubber</b>	<ul style="list-style-type: none"> <li>• Excellent holding power</li> <li>• Good initial adhesion above 40°F</li> <li>• Meets ASTM D-5486 government specification</li> </ul>	
	<b>Acrylic</b>	<ul style="list-style-type: none"> <li>• Excellent initial adhesion over a broad temperature range</li> <li>• Extremely long performance life</li> <li>• UV and chemical resistance</li> </ul>	

Delivering service and support to help you select the right 3M product for your application. On-site consultation with experienced 3M engineers and sales specialists are standing by to help.

# Box Sealing Tape Selector

Use this selector to help determine a box sealing tape that meets your packaging needs. **The suggestions provided by this method must be confirmed by testing.** Additional packaging and shipping factors should also be considered.

Circle the point value that best describes your operations		
	Point Value	Points
<b>1. How much does the filled box weigh?</b>		
a. 10 pounds	10	
b. 20 pounds	20	
c. 30 pounds	25	
d. 40 pounds	30	
e. 50 pounds	35	
f. 70 pounds	45	
g. 80 pounds	50	
h. 100 pounds	60	
<b>2. What is the carton burst/ECT test?</b>		
a. 150 SW/26	5	
b. 175 SW/29	10	
c. 200 SW/32	15	
d. 250 SW/40	20	
e. 275 SW/44	25	
f. 350 SW/55	30	
g. 200 DW/42	35	
h. 275 DW/48	40	
i. 350 DW/51	45	
<b>3. What is the value of contents?</b>		
a. <\$100	10	
b. \$100-\$1000	25	
c. >\$1000	40	
<b>4. What is the method of shipment?</b>		
a. Palletized and unitized	5	
b. Palletized but not unitized	15	
c. Single	30	
<b>5. Type of carrier</b>		
a. Company truck	5	
b. Commercial transport/LTL	15	
c. UPS/USPS/FEDEX	30	
<b>Total Points</b>		

Choose an effective closure...choose 3M		
205		
195		72mm
180		
165		72mm
150		
135		48mm
120		48mm
105		
90		42mm
75	72mm	
60	48mm	
45		36mm
	42mm	
35		36mm
	36mm	
	<b>Scotch® Box Sealing Tape Recommended for Testing</b>	
<b>Your Total Points</b>	<b>3071</b>	<b>373</b>
	<b>371</b>	<b>313</b>
	<b>371+</b>	<b>3073</b>
	<b>311+</b>	<b>355</b>

These suggestions are based on experience, but there are factors which could alter the overall performance. **For example:**

Cartons with center seam gap greater than 3/4" or over packed/under packed cartons should be tested with 3" (72mm) wide tape

Hard-to-stick surfaces and Recycled Corrugate Boxes, test Scotch® Recycled Corrugate Tape 371+, 3071 and 3073

Box sealing tapes are available custom printed and with standard security messages

Applications when tape is applied under 40°F, test Scotch® Box Sealing Tape 311+, 313 and 3073

If your package is unusual in size, shape, or load, try the 3M Technical Service Request (TSR) Program. Using the 3M TSR Program, a 3M representative will work with you on initial testing of a Scotch® Box Sealing Tape. One or two best options will be identified then a sample of your substrate is brought to the 3M Laboratories and tested for stress or other factors the product will encounter. The 3M test results will help you select the best box sealing tape for your manufacturing process and customer needs.



# Scotch® and Tartan™ Box Sealing Tapes

## Dependability for food and beverage, electronics, e-fulfillment, pharmaceuticals and more.

With choices of polyester or polypropylene backings and synthetic rubber or acrylic adhesives, you have dependability for a wide variety of box types, sizes, contents, handling situations and storage conditions.

- Reliability even with the stresses of over packed or under packed boxes
- Quick, easy application by hand, manual dispensers or 3M-Matic™ Case Sealers
- Choice of lengths, widths, backings, adhesives and colors to meet specific needs

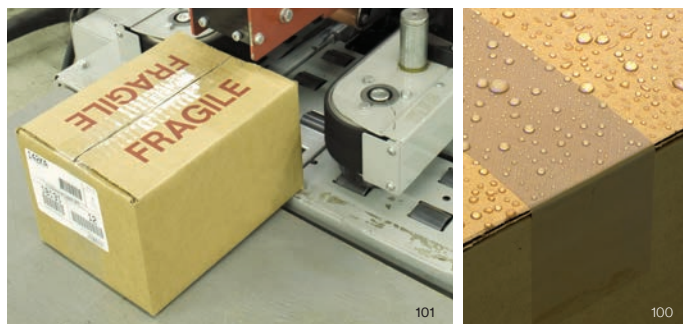

Consistent quality of Scotch® Box Sealing Tapes means fewer interruptions on your packaging line.

Scotch® Box Sealing Tapes with polyester backing and synthetic rubber adhesive resist the moisture in storage and shipping.



Product	Tape Structure (Backing/Adhesive)	Adhesion to Steel oz/in (N/100mm)	Tensile Strength lbs/in (N/100mm)	Elongation at Break (%)	Backing Thickness mils (mm)	Total Thickness mils (mm)	Available Colors/Comments
<b>ASTM Test Method</b>		<b>D-3330</b>	<b>D-3759</b>	<b>D-3759</b>	<b>D-3652</b>	<b>D-3652</b>	
<b>Scotch® Box Sealing Tapes</b>							
<b>311+</b>		38 (42)	25 (438)	125	1.1 (0.028)	2.05 (0.052)	
<b>313</b>	Polypropylene/ Acrylic	32 (35)	35 (613)	125	1.6 (0.041)	2.55 (0.065)	Clear
<b>315</b>		38 (41.5)	23 (403)	200	2.3 (0.058)	3.5 (0.089)	
<b>351</b>	Polyester/ Synthetic Rubber	78 (85)	67 (1174)	130	2.0 (0.051)	3.43 (0.087)	Clear, Tan or Custom Printed
<b>353</b>		45 (49)	25 (438)	110	1.0 (0.025)	1.9 (0.048)	Clear, Tan
<b>355</b>		78 (85)	67 (1174)	130	2.0 (0.051)	3.43 (0.087)	Clear, Tan or Custom Printed
<b>371</b>	Polypropylene/ Synthetic Rubber	40 (44)	22 (385)	160	1.2 (0.030)	1.8 (0.046)	Clear, Tan, Blue, Green, Orange, Red, White, Yellow or Custom Printed
<b>371+</b>		42 (46)	22 (385)	160	1.2 (0.030)	1.9 (0.050)	Clear or Custom Printed
<b>373</b>		50 (55)	30 (525)	160	1.6 (0.041)	2.5 (0.064)	Clear, Tan, Blue, Green, Orange, Red, White, Yellow or Custom Printed
<b>375</b>		55 (60)	35 (613)	160	2.0 (0.051)	3.1 (0.079)	Clear, Tan or Custom Printed
<b>Tartan™ Box Sealing Tapes</b>							
<b>302</b>	Polypropylene/ Acrylic	14 (15)	18 (309)	110	1.0 (0.025)	1.7 (0.042)	Clear, Tan
<b>305</b>		16 (18)	18 (309)	110	1.0 (0.025)	1.8 (0.045)	
<b>369</b>	Polypropylene/ Synthetic Rubber	30 (33)	19 (333)	160	1.0 (0.025)	1.6 (0.041)	

**Note:** This technical information and data should be considered representative or typical only and should not be used for specification purposes.



# Scotch® Recycled Corrugate Tapes

With environmental standards changing rapidly and companies constantly seeking new ways to reduce costs and improve their environmental footprint, packaging materials are in a constant state of flux. Scotch® Recycled Corrugate Tapes are designed to help you stay on top of the changes.

- They're tackier than conventional box sealing tapes
- Made with a proprietary adhesive designed specifically for recycled corrugate cartons

Who knows what kind of abuse your box goes through after it leaves your facility? Make sure it stays sealed with Scotch® High Tack Box Sealing Tape 371+.

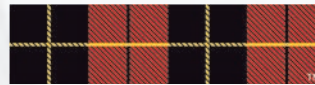

It's not sealed until it's Scotch® Sealed.

## Excellent performance — even on highly recycled corrugated boxes.

Be confident your boxes will stay closed throughout the entire supply chain with industrial-strength Scotch® High Tack Box Sealing Tape 371+.

- Adheres to a wide range of materials, including corrugated boxes with 100% recycled content
- Polypropylene backing with synthetic rubber adhesive conforms around edges and rough surfaces
- Good edge tear and split resistance
- Resists abrasion, moisture, chemicals and scuffing
- Easy to unwind and dispense by hand, with manual dispensers, or with 3M-Matic™ Case Sealers



Product	Tape Structure (Backing/Adhesive)	Adhesion to Steel oz/in (N/100mm)	Tensile Strength lbs/in (N/100mm)	Elongation at Break (%)	Backing Thickness mils (mm)	Total Thickness mils (mm)	Available Colors/Comments
<b>ASTM Test Method</b>		<b>D-3330</b>	<b>D-3759</b>	<b>D-3759</b>	<b>D-3652</b>	<b>D-3652</b>	
<b>311+</b>	Polypropylene/Acrylic	38 (42)	25 (438)	125	1.1 (0.028)	2.05 (0.052)	Clear
<b>371+</b>	Polypropylene/Synthetic Rubber	42 (46)	22 (385)	160	1.2 (0.030)	1.9 (0.050)	Clear and Custom Printed; 10% bio-based content and for use on recycled corrugate cartons
<b>3073</b>		46 (50)	30 (525)	160	1.6 (0.041)	2.6 (0.066)	

Note: This technical information and data should be considered representative or typical only and should not be used for specification purposes.





# Scotch® Custom Printed Box Sealing Tapes

## Let them know exactly who the package came from.

With every delivery, Scotch® Custom Printed Box Sealing Tape helps you differentiate your packages from the competitors. Whether you include your logo, tagline or other promotional messaging, your package will surely get noticed.

- Printed message won't rub off during transit
- Can be used to print handing instructions or labeling, replacing the need to carry large inventories of various printed cartons
- Adds security by discouraging tampering



224

Easily conforms around edges	✓
Strong seal on rough surfaces	✓
Holds through wide temperature variations	✓
Resists moisture in storage and shipping	✓
Resists nicks and abrasions	✓
Ideal for food and beverage	✓
Quick, easy application	✓



225

Scotch® Box Sealing Tapes can be custom printed in up to 10 colors. Choose from the entire library of Pantone® Inks to match your logo brand or theme.

Product	Tape Structure (Backing/Adhesive)	Adhesion to Steel oz/in (N/100mm)	Tensile Strength lbs/in (N/100mm)	Elongation at Break (%)	Backing Thickness mils (mm)	Total Thickness mils (mm)	Available Colors/Comments
ASTM Test Method		D-3330	D-3759	D-3759	D-3652	D-3652	
355CP	Polyester/ Synthetic Rubber	78 (85)	67 (1174)	130	2.0 (0.051)	3.43 (0.087)	Clear, Tan
371CP	Polypropylene/ Synthetic Rubber	40 (44)	22 (385)	160	1.2 (0.030)	1.8 (0.046)	Clear, Tan, Blue, Green, Orange, Red, White, Yellow
373CP		50 (55)	30 (525)	160	1.6 (0.041)	2.5 (0.064)	Clear, Tan, Blue, Green, Orange, Red, White, Yellow
375CP		55 (60)	35 (613)	160	2.0 (0.051)	3.1 (0.079)	Clear, Tan
3071CP		45 (49)	22 (385)	160	1.2 (0.030)	2.1 (0.053)	For use on recycled corrugate cartons
3073CP		46 (50)	30 (525)	160	1.6 (0.041)	2.6 (0.066)	10% bio-based content and for use on recycled corrugate cartons

PANTONE® is the property of Pantone LLC.

**Note:** This technical information and data should be considered representative or typical only and should not be used for specification purposes.

# Scotch® Cold Temperature Tape

## Extreme performance even in cold temperatures.

- Adheres to a variety of surfaces, including on corrugated boxes with over 70% recycled content.
- Can be applied at freezer and refrigeration temperatures of 20°F to 50°F (-6.6°C to 10°C).
- Once applied, performs well on fiberboard boxes subjected to temperatures below 32°F (0°C).
- Quick, easy application by hand, manual dispensers or 3M-Matic™ Case Sealers.



246



226



102

For box packing, sealing and storage below 40°F, Scotch® Box Sealing Tape 311+ seal with a rubber adhesive modified for reliability in the cold.

Product	Tape Structure (Backing/Adhesive)	Adhesion to Steel oz/in (N/100mm)	Tensile Strength lbs/in (N/100mm)	Elongation at Break (%)	Backing Thickness mils (mm)	Total Thickness mils (mm)	Available Colors/Comments
<b>ASTM Test Method</b>		<b>D-3330</b>	<b>D-3759</b>	<b>D-3759</b>	<b>D-3652</b>	<b>D-3652</b>	
<b>311+</b>	Polypropylene/Acrylic	38 (42)	25 (438)	125	1.1 (0.028)	2.05 (0.052)	Clear

# Scotch® Security Tapes

## Deter package tampering.

Scotch® Security Box Sealing Tapes are ideal for sealing packages and securing loads with high value contents. Printed messages communicate the need for careful package inspection prior to acceptance and reduce theft during the shipping process. Available with a variety of pre-printed messages.



227



103

228



# Scotch® Specialty Box Sealing Tapes

## Dependability for security, gapped flap cartons and more.

Starting with the same dependability and durability of Scotch® Box Sealing Tapes, specialty tapes add specialized form and/or functional properties for specific applications.



Product	Tape Structure (Backing/Adhesive)	Adhesion to Steel oz/in (N/100mm)	Tensile Strength lbs/in (N/100mm)	Elongation at Break (%)	Backing Thickness mils (mm)	Total Thickness mils (mm)	Available Colors/Comments
<b>ASTM Test Method</b>		<b>D-3330</b>	<b>D-3759</b>	<b>D-3759</b>	<b>D-3652</b>	<b>D-3652</b>	
<b>Box Repair Tapes</b>							
2517	Kraft Paper/Rubber	78 (85)	35 (543)	2	4.5 (0.11)	6.5 (0.16)	Medium Brown, Excellent splicing
2519		41 (45)	45 (790)	2	5.5 (0.14)	7.1 (0.18)	Kraft (Tan)
2525	Flatback Paper/Rubber	69 (75)	49 (858)	2	7.7 (0.19)	9.5 (0.24)	Orange, Premium splicing
2526		69 (75)	50 (858)	4	8.0 (0.20)	9.8 (0.24)	White, Excellent adhesion

Product	Tape Structure (Backing/Adhesive)	Basis Weight	Caliper (mils)	Tensile Strength (lbs / in)	Tear Strength (grams)	Available Colors/Comments
<b>ASTM Test Method</b>		<b>D-646</b>	<b>D-645</b>	<b>D-5803</b>	<b>D-1922</b>	
<b>Water Activated Tapes</b>						
6141	Paper backing/gummed modified cornstarch based adhesive	35	3.5	30	72	Kraft (Tan) or Custom Printed
6142		60	5.5	44	125	
6143		90	7.5	58	200	
6144	Paper backing with filament reinforcement/gummed modified cornstarch based adhesive	23 / 23	4.9	45-50	N/A	Kraft (Tan) or Custom Printed
6145		23 / 23 (Kraft) 30 / 23 (White)	5.0 (Kraft) 7.3 (White)	52-57	N/A	Kraft (Tan), White or Custom Printed
6146		30 / 23	6.5	60-65	N/A	Kraft (Tan) or Custom Printed
6147		23 / 23 (Kraft)	8.5	60-65	N/A	Kraft (Tan) or Custom Printed

Product	Tape Structure (Backing/Adhesive)	Adhesion to Steel oz/in (N/100mm)	Tensile Strength lbs/in (N/100mm)	Elongation at Break (%)	Backing Thickness mils (mm)	Total Thickness mils (mm)	Available Colors/Comments
<b>ASTM Test Method</b>		<b>D-3330</b>	<b>D-3759</b>	<b>D-3759</b>	<b>D-3652</b>	<b>D-3652</b>	
<b>Security Tapes</b>							
3199	Polypropylene/Acrylic	22 (24)	25 (438)	125	1.1 (0.028)	2.05 (0.052)	Clear with Red Type: CHECK SEAL BEFORE ACCEPTING
3732	Polypropylene/Synthetic Rubber	50 (55)	30 (525)	160	1.6 (0.041)	2.5 (0.064)	Tan with Red Type: IF SEAL IS BROKEN CHECK CONTENTS BEFORE ACCEPTING
3771		40 (44)	22 (385)	160	1.2 (0.030)	1.8 (0.046)	White with Red Type: IF SEAL IS BROKEN CHECK CONTENTS BEFORE ACCEPTING
3772		40 (44)	22 (385)	160	1.2 (0.030)	1.8 (0.046)	White with Red Type: FRAGILE HANDLE WITH CARE
3775		40 (44)	22 (385)	160	1.2 (0.030)	1.8 (0.046)	White with Red Type: MIXED MERCHANDISE ENCLOSED
3779		40 (44)	22 (385)	160	1.2 (0.030)	1.8 (0.046)	Clear with Red Type: CHECK SEAL BEFORE ACCEPTING

Note: This technical information and data should be considered representative or typical only and should not be used for specification purposes.

# Light Duty Packaging Tapes

**Versatility with choices of film backings and adhesives for application success.**

## Typical Light Duty Applications

- Garment bundling
- Plastic bag closure
- Party tray closure
- Small box closure
- Document envelope closure
- Inner pack box closure



104



231

## Scotch® Light Duty Packaging Tape 640 Clean Removal Apparel

UPVC backing with clean removal acrylic adhesive for a wide variety of fabric finishes and treatments, including for tabbing shirts and underwear.



232

## Scotch® Light Duty Packaging Tape 605 Cold Temperature

Polypropylene backing with acrylic adhesive for cold temperature applications, such as closing a plastic tray lid.



233

## Scotch® Light Duty Packaging Tape 600 High Clarity

UPVC backing with high tack acrylic adhesive for holding apparel.

## Scotch® Color Coding Tape 690

UPVC backing with natural rubber adhesive for sealing and color coding.



234

## Variety of Surfaces

- Fabrics
- Molded plastics
- Metals
- Clay-coated paperboard
- Corrugated
- Vinyl and films



# Light Duty Packaging Tapes

Product	Color	Backing Material	Backing Thickness mils (mm)	Total Thickness mils (mm)	Tensile Strength lb/in (N/100mm)	Adhesive Type	Adhesion to Steel oz/in (N/100mm)	Elongation (%)	Typical Use	Comments
<b>Light Duty Packaging Tapes</b>										
600	Clear	UPVC	1.5 (0.038)	2.3 (0.058)	28 (490)	Acrylic	32 (35)	45	L-Clip closure, attaching, tabbing and holding	Excellent handling, high clarity and long aging
605	Clear	Polypropylene	1.6 (0.041)	2.5 (0.064)	22 (385)	Acrylic	27 (30)	57	Cold temperature packaging	Cold temperature applications; Complies to FDA Regulations for indirect food contact
610	Clear	Cellophane	1.4 (0.036)	2.3 (0.058)	23 (402)	Natural Rubber	33 (36)	15	Splicing	High heat applications up to 300°F
640	Clear	UPVC	1.2 (0.030)	1.9 (0.048)	32 (560)	Acrylic	22 (25)	65	Tabbing and holding of apparel	Clean removal from wide variety of fabrics and substrates
660	Red	Cellophane	1.4 (0.036)	2.5 (0.064)	20 (350)	Natural Rubber	50 (55)	10	Splicing and easy detection	High heat applications up to 300°F; High adhesion
681	Clear	UPVC	1.5 (0.038)	2.4 (0.061)	25 (438)	Natural Rubber	40 (44)	35	Sealing	Resists moisture and chemicals; Heat shrinkable; Complies with US FDA 21 CFR 175.105 for indirect food contact
690	Black, Blue, Green, Red, Yellow, White	UPVC	1.5 (0.038)	2.3 (0.058)	35 (613)	Natural Rubber	30 (33)	45	Color coding	Resists moisture and chemicals; Heat shrinkable
856	Transparent	Polyester	1.0 (0.025)	2.0 (0.051)	25 (438)	Acrylic	20 (22)	90	Tough backing for good tear resistance	Tough backing for good tear resistance
5910	Clear	Polypropylene	1.2 (0.030)	2.0 (0.051)	18 (315)	Acrylic	16 (17)	90	Utility grade for light duty packaging	Conforms easily
<b>Fingerprint Lifting Tape</b>										
8004	Clear	Polypropylene	1.4 (0.036)	2.0 (0.051)	18 (315)	Acrylic	16 (17)	90	Ultra clear tape; Handles easily	Lift and preserve physical evidence such as fingerprints

## Technologies matched to the applications.

### Choice of Backings

- UPVC for transparency plus moisture, chemical and UV resistance; non-staining and heat-shrinkable
- Polypropylene for transparency plus conformability and flexibility
- Cellophane for heat resistance
- Polyester for strength and abrasion resistance

### Choice of Adhesives

- Acrylic for long aging and UV resistance
- Rubber for high initial bond strength and adhesion to wide variety of materials including hard-to-bond plastics

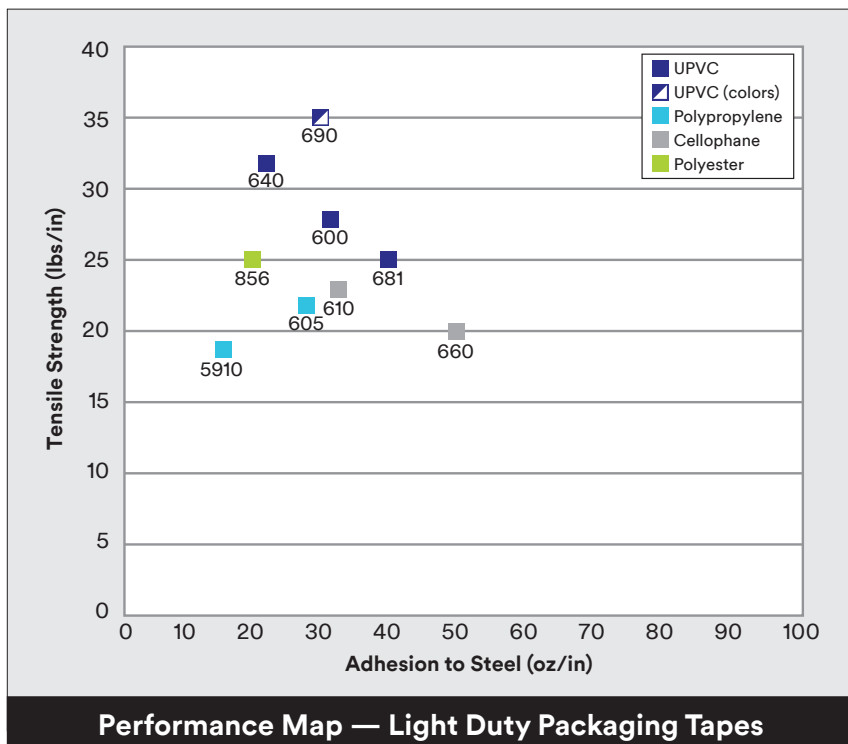

Note: This technical information and data should be considered representative or typical only and should not be used for specification purposes.



# High Strength Tapes

When you need a tape as strong as your reputation, you can count on 3M's consistently reliable, high strength tapes that are engineered to meet virtually any strapping, bundling or reinforcing challenge.



# High Strength Tapes

## For packaging and non-packaging applications.

**Selection:** Our range of high strength tape constructions can help balance your product performance and budget needs.

**Save time and money:** Let 3M's application and technical experts, backed by a robust lab testing capability, help match the right tape to your performance requirements.

**Peace of mind:** Scotch® and 3M brands are among the most innovative and trusted in the world. Our world-class tape manufacturing facilities churn out consistent and reliable products, roll after roll.

## Streamlined selection for application success.

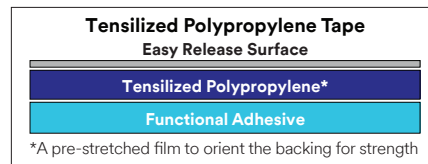
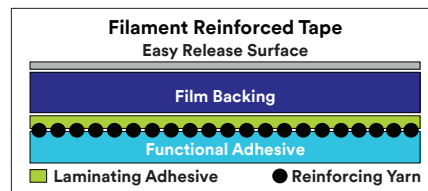

114



Pallet Unitizing



Carpet Bundling



L- and U-Clip Closures



Bundling for Shipping and Handling



PVC Pipe Bundling



Stabilizing Loose Parts

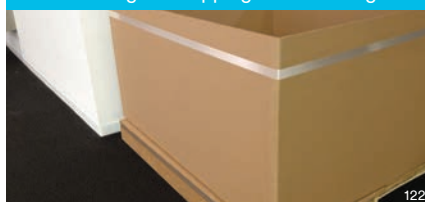

Bulk Bin or Skid Box Banding



Rebar Bundling

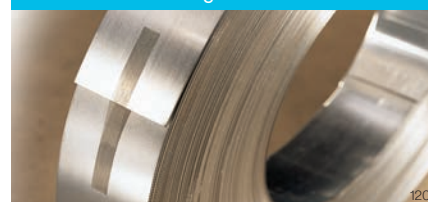

Metal Coil Tabbing

Product	Description	Tensile Strength*
8934	Glass yarn reinforced	100 lbs/in
860	Tensitized polypropylene	110 lbs/in
862	Reinforced strapping tape for strength AND high tape clarity	120 lbs/in

Product	Description	Tensile Strength*
897	Glass yarn reinforced	170 lbs/in
893	Glass yarn reinforced	300 lbs/in
880	Polyester yarn reinforced	270 lbs/in

Product	Description	Tensile Strength*
898	Glass yarn reinforced, first choice for L- or U-Clip closure of non-RSC boxes	380 lbs/in
890MSR	Glass yarn reinforced, modified synthetic rubber adhesive for oily surfaces	600 lbs/in
8899HP	Tensitized polypropylene, clean removal	160 lbs/in

\*ASTM Test Method D-3759.

**Note:** This technical information and data should be considered representative or typical only and should not be used for specification purposes.

# High Strength Filament Tapes

A go-to source for filament tapes since 1946.

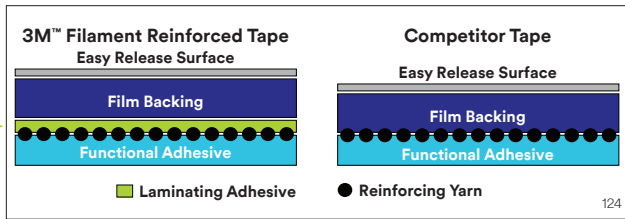

**3M's laminating adhesive layer** provides an extra measure of protection against tape delamination to help ensure tape strength and performance throughout the application. With 3M, you get more consistency, reliability and confidence.



Scotch® High Strength Filament Tape 898



Scotch® High Strength Filament Tape 890MSR (Black)



Tartan™ High Strength Filament Tape 8934



Scotch® High Strength Filament Tape 880

## Technologies matched to the applications.

### Choice of Adhesives

- **SR (Synthetic Rubber):** Versatile, good adhesion to many surfaces
- **MSR (Modified Synthetic Rubber):** Designed for adhesion to oily surfaces
- **RCT:** Designed for adhesion to recycled corrugate and other hard-to-stick-to-surfaces

### Choice of Backings

- **Polypropylene:** Good abrasion, moisture and scuff resistance; excellent conformability
- **Polyester:** Tough, strong backing; handles and dispenses easily

### Choice of Filament

- **Fiberglass:** Higher tensile strength for security and stretch resistance for stability
- **Polyester:** Higher elongation for better shock absorption and impact resistant

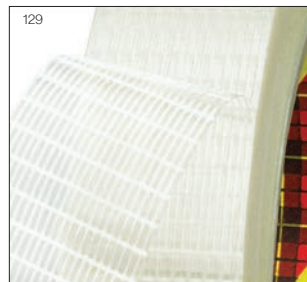

## Scotch® Bi-Directional Filament Tape 8959

- Superior cut and puncture resistance
- Extra box or package security against pilferage
- Highest adhesion in our high strength tape offering

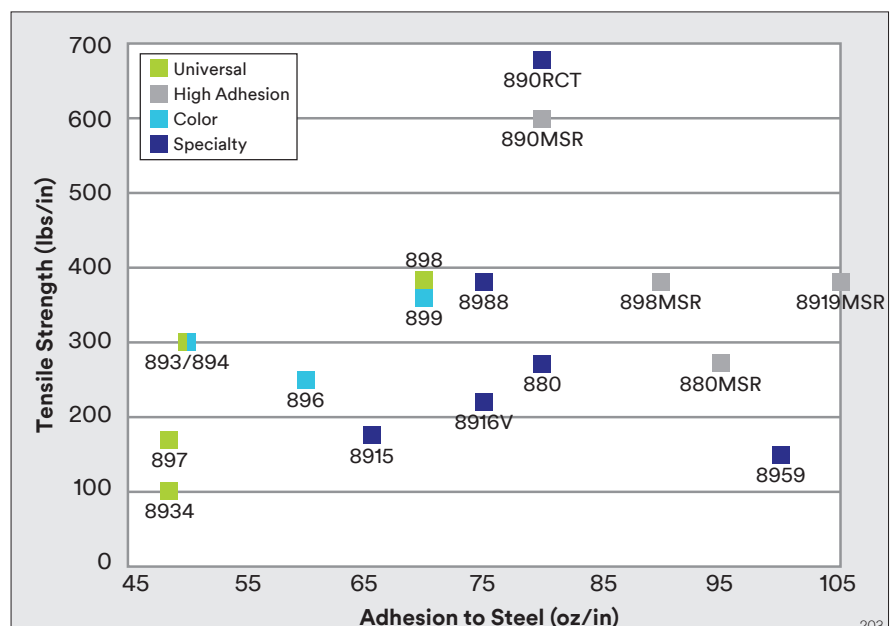

Performance Map — Filament Reinforced Tapes

Note: This technical information and data should be considered representative or typical only and should not be used for specification purposes.





# High Strength Filament Tapes

Product	Tensile Strength lb/in (N/100mm)	Backing Material	Reinforcement	Total Thickness mils (mm)	Adhesive Type	Adhesion Strength oz/in (N/100mm)	Elongation (%)	Backing Color	Typical Use and Comments
<b>ASTM Test Method</b>	<b>D-3759</b>			<b>D-3652</b>		<b>D-3330</b>			
<b>Universal Filament</b>									
<b>898</b>	380 (6655)	Polypropylene	Glass Yarn	6.6 (0.168)	Synthetic Rubber (SR)	70 (77)	5	Clear	L-Clip box closure, General bundling and reinforcing; Very high strength, Versatile, Good adhesion to many substrates
<b>893</b>	300 (5254)	Polypropylene	Glass Yarn	5.3 (0.135)	Synthetic Rubber (SR)	50 (55)	4	Clear	Box closing, palletizing, strapping, bundling and reinforcing; High strength
<b>897</b>	170 (2977)	Polypropylene	Glass Yarn	5.0 (0.127)	Synthetic Rubber (SR)	50 (55)	4	Clear	Box closing, palletizing, strapping, bundling and reinforcing; Medium strength
<b>8934</b>	100 (1751)	Polypropylene	Glass Yarn	4.0 (0.102)	Synthetic Rubber (SR)	48 (53)	3	Clear	Box closing, palletizing, strapping, bundling and reinforcing; Utility
<b>Colored Filament</b>									
<b>899</b>	360 (6305)	Polypropylene	Glass Yarn	6.6 (0.168)	Synthetic Rubber (SR)	70 (77)	3	Red	General bundling and reinforcing; Red color for increased visible and detection
<b>894</b>	300 (5254)	Polypropylene	Glass Yarn	6.0 (0.15)	Synthetic Rubber (SR)	50 (55)	4.5	Black	Pipe bundling and other outdoor applications; High UV resistance
<b>896</b>	240 (4203)	Polypropylene	Glass Yarn	5.4 (0.137)	Synthetic Rubber (SR)	60 (66)	3	White	Heavy box closure, general bundling and reinforcing; White boxes, Color coding
<b>High Adhesion Filament</b>									
<b>890MSR</b>	600 (10508)	Polyester	Glass Yarn	8.0 (0.203)	Modified Synthetic Rubber (MSR)	80 (88)	3	Clear/Black	Metal coil closure; Good adhesion to oily surfaces
<b>898MSR</b>	380 (6655)	Polyester	Glass Yarn	6.0 (0.15)	Modified Synthetic Rubber (MSR)	90 (99)	3	Clear	Metal coil closure; Good adhesion to oily surfaces
<b>8919MSR</b>	380 (6655)	Polyester	Glass Yarn	7.0 (0.180)	Modified Synthetic Rubber (MSR)	105 (110)	3	Clear	Metal coil closure; Good adhesion to oily surfaces, Thicker backing for improved handling
<b>880MSR</b>	270 (4728)	Polyester	Polyester Yarn	7.7 (0.196)	Modified Synthetic Rubber (MSR)	95 (104)	19	Clear	Metal coil closure; Good adhesion to oily surfaces, High cut resistance
<b>Specialty Filament</b>									
<b>890RCT</b>	680 (11909)	Polyester	Glass Yarn	8.0 (0.203)	Synthetic Rubber (RCT)	80 (88)	5	Clear	Basiloid, Heavy appliance lifting; Good adhesion to recycled corrugate
<b>8988</b>	380 (6655)	Polypropylene	Glass Yarn	6.9 (0.175)	Synthetic Rubber (RCT)	75 (82)	3	Clear	L-Clip box closure; Good adhesion to recycled corrugate
<b>880</b>	270 (4728)	Polypropylene	Polyester Yarn	7.7 (0.196)	Synthetic Rubber (SR)	80 (88)	19	Clear	Pipe and conduit, bundling and color coding; Excellent shock resistance
<b>8959</b>	150 (2627)	Polypropylene	Bi-Directional Yarn	5.7 (0.145)	Synthetic Rubber (SR)	100 (109)	6	Clear	Heavy box closure, Splicing, Metal parts bundling; Bi-directional filament for excellent cut and puncture resistance; High adhesion
<b>8916V</b>	210 (3678)	Polypropylene	Glass Yarn	6.8 (0.172)	Synthetic Rubber (SR)	75 (82)	3	Clear/Blue	Appliance, Secure and stabilize parts; Clean removal, Thicker backing
<b>8915</b>	170 (2977)	Polypropylene	Glass Yarn	6.0 (0.15)	Synthetic Rubber (SR)	65 (71)	3	Clear	Appliance, Secure and stabilize parts; Clean removal

**Note:** This technical information and data should be considered representative or typical only and should not be used for specification purposes.

# Tensitized Polypropylene Tapes

## Clean removal.

- MOPP (monoaxially-oriented polypropylene) tape construction
- High strength tapes that hold firm, remove cleanly with no adhesive residue
- Great adhesion to vinyl and other plastics, glass, painted and unpainted metals, or powder coated
- Holds shelving, racks, doors, panels, cords, other parts in place, from plant to install



12



140

Bundle plastic, metal, stainless steel, glass, powdercoat or other coated electronic, appliance or automotive parts during assembly and transportation.

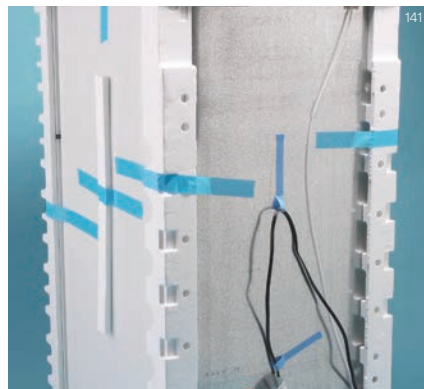

141

Hold packaging materials, spacers, corner boards, power cords and other hard-to-manage parts firmly in place.



201

Appliance racks, shelves, drawers and doors can be secured, from plant to install, then removed cleanly with no adhesive residue.

Product	Tensile Strength lb/in (N/100mm)	Backing Material	Reinforcement	Total Thickness mils (mm)	Adhesive Type	Adhesion Strength oz/in (N/100mm)	Elongation (%)	Color	Typical Use and Comments
<b>ASTM Test Method</b>	<b>D-3759</b>			<b>D-3652</b>		<b>D-3330</b>			
<b>8899HP</b>	160 (2802)	Polypropylene	None	4.8 (0.12)	Rubber	45 (49)	30	Blue/ Ivory/ White	Secure and stabilize parts, clean removal and high/low temperature performance
<b>8898</b>	160 (2802)	Polypropylene	None	4.6 (0.117)	Synthetic Rubber	75 (82)	32	Blue/ Ivory	Appliance, Secure and stabilize parts; Clean removal, High adhesion
<b>860</b>	110 (1926)	Polypropylene	None	2.8 (0.071)	Synthetic Rubber	45 (49)	33	Black	General bundling and strapping; Utility grade for pallet unitizing

Note: This technical information and data should be considered representative or typical only and should not be used for specification purposes.



# Scotch® Reinforced Strapping Tapes

3M's **CLEAREST** high-strength tape available.



## Why 3M?

**Strong:** Polypropylene backing extruded to create monofilament "ribs"

**Secure:** Resists nicking, cutting, tearing or puncturing during handling

**Clear:** No filaments to obstruct graphics

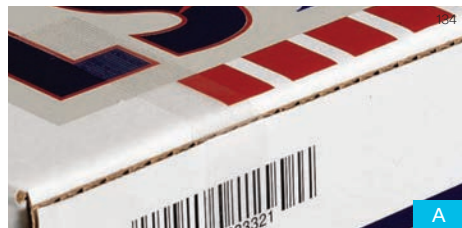

Scotch® Reinforced Strapping Tape 8651



Scotch® Reinforced Strapping Tape 862

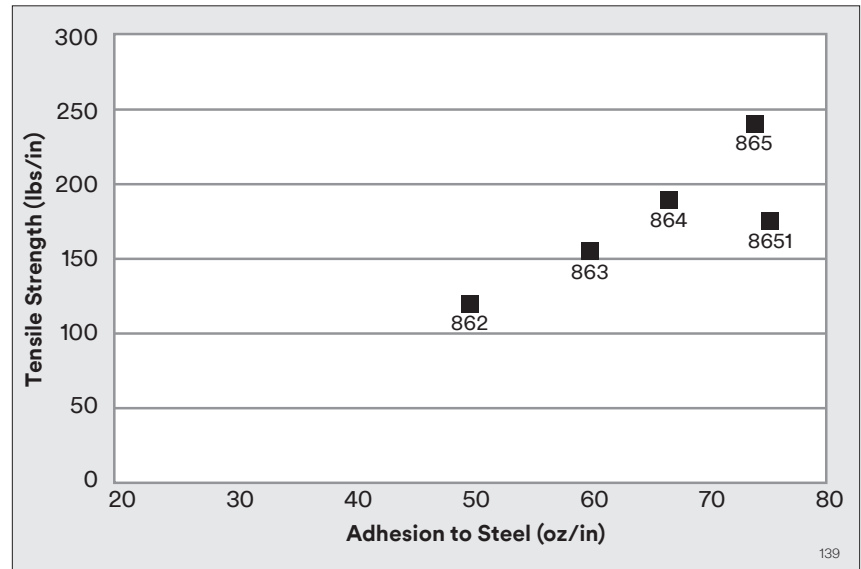

Performance Map — Reinforced Strapping Tapes

Product	Clarity to Showcase Marketing Content	Barcode Scannable	Resists Nicks	Resists Abrasion	Does it Scratch?
A. Reinforced Strapping Tape	Yes	Yes	Yes	Yes	No
B. Reinforced Gummed Paper Tape	No	No	Yes	Somewhat	No
C. Staples	Somewhat	No	N/A	N/A	Yes
D. Filament Tape	Somewhat	No	Yes	Yes	No
E. Tensitized Polypropylene Tape	No	No	No	Yes	No

Product	Tensile Strength lb/in (N/100mm)	Backing Material	Reinforcement	Total Thickness mils (mm)	Adhesive Type	Adhesion Strength oz/in (N/100mm)	Elongation (%)	Color	Typical Use and Comments
<b>ASTM Test Method D-3759</b>		<b>D-3652</b>			<b>D-3330</b>				
865	240 (4203)	Polypropylene	Polypropylene	6.4 (0.163)	Synthetic Rubber	74 (81)	30	Clear	Palletizing; L-Clip box closure; High clarity for use on highly graphic boxes; Bar code readable
864	190 (3327)	Polypropylene	Polypropylene	5.6 (0.142)	Synthetic Rubber	67 (73)	30	Clear	Palletizing; L-Clip box closure; High clarity for use on highly graphic boxes; Bar code readable
8651	175 (3065)	Polypropylene	Polypropylene	5.6 (0.142)	Synthetic Rubber	75 (82)	30	Clear	Palletizing; L-Clip box closure; High clarity for use on highly graphic boxes; Bar code readable
863	155 (2714)	Polypropylene	Polypropylene	5.0 (0.127)	Synthetic Rubber	60 (66)	30	Clear	Palletizing; L-Clip box closure; High clarity for use on highly graphic boxes; Bar code readable
862	120 (2102)	Polypropylene	Polypropylene	4.6 (0.117)	Synthetic Rubber	50 (55)	30	Clear/Black	Pipe Bundling; Black for UV resistance

**Note:** This technical information and data should be considered representative or typical only and should not be used for specification purposes.

# Scotch® Stretchable Tapes

## Tape that gets stronger as it's S-T-R-E-T-C-H-E-D

- Adhesive “de-tackifies” when stretched: holds in place but won't damage carton graphics, shipping instructions or other pallet information when removed
- 650% stretch factor: 55-meter roll yields 357 meters of tape
- Creates ventilated load for shipment of time- and temperature-sensitive goods
- More stability — less waste

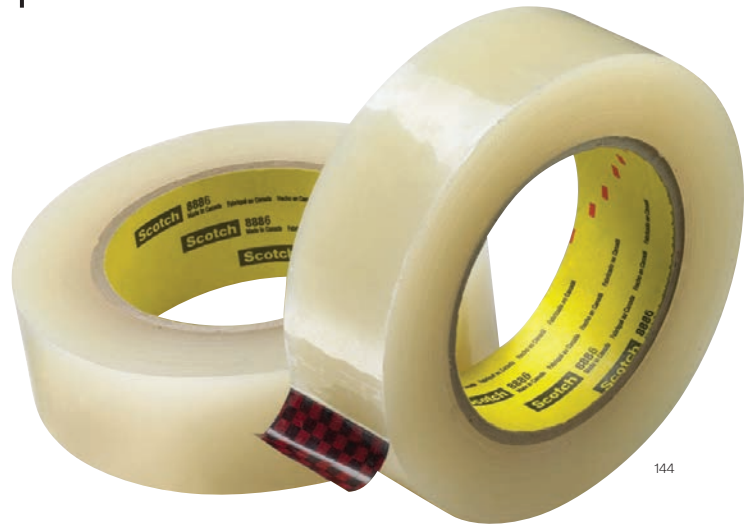

144



145

High yield! One 55-meter roll can unitize 60 or more A- or B-style pallets for intra-plant movement.



146

“X”-pattern can contain loads for shipment anywhere.



147

Less waste! Compare the 3M™ Stretchable Tape waste “ball” on the left versus the size of typical stretch film waste on the right.



148



149



89

### Scotch® Stretchable Tape Dispenser H38

Hand-held dispenser with tensioning/stretching brake for use with Scotch® Stretchable Tapes (see page 16).

Product	Tensile Strength lb/in (N/100mm)	Backing Material	Total Thickness mils (mm)	Adhesive Type	Adhesion Strength oz/in (N/100mm)	Elongation (%)	Color	Comments
ASTM Test Method	D-3759		D-3652		D-3330			
8886	28 (490)	Polyethylene	7.0 (0.18)	Synthetic Rubber	65 (71)	720	Clear	Load containment
8884	20 (350)	Polyethylene	5.0 (0.127)	Synthetic Rubber	70 (77)	710	Clear	Palletizing for intra-plant movement; Load containment; For hand application using Scotch® Stretchable Tape Dispenser H38

Note: This technical information and data should be considered representative or typical only and should not be used for specification purposes.



# Custom Packaging Solutions

# 3M™ Carry Handles

## Applied at Retail Checkout

### Convenience for your customer.

- Pre-cut padded carry handles for easy application
- Quickly and easily transform bulky purchases into travel-friendly packages
- Custom print! Put your BRAND in consumer's hands
- Custom size to meet your store profile
- Great alternative to large retail shopping bag. Save a bag...offer a handle
- Reduce plastic waste by 97%\* by offering a carry handle

\*Based on weight of large plastic bag of 75 grams vs. 3M™ Carry Handle of 2.5 grams.



## Pre-Applied By Manufacturer

### Give your products a lift.

- Differentiate your on-shelf appeal — customers will associate convenience with your brand
- Easily combine two stand up pouches for a unique duo-pouch solution
- Printed handles communicate — drive brand awareness, augment or replace other package information
- Convenience: Promo packs and up-sized SKUs can be easily carried from store to car or bus to home or office
- Ask your 3M Packaging Specialist for details on automated application equipment
- Range of carry handle options — pre-cut (hand applied) or in-line pre-laminated (machine applied)





# 3M™ Carry Handles

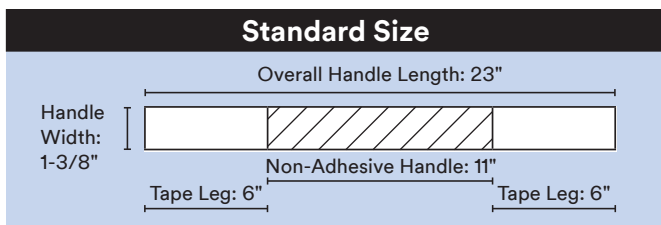

**Weight**

carry handle 2.5g

large retail plastic bag 75.0g

Reduce plastic waste by **97%**



## Pre-cut padded carry handles for hand application.

Product	Weight Holding Capacity (lbs)	Tape Material	Total Thickness mils (mm)	Tensile Strength lb/in (N/100mm)	Adhesive Type	Adhesion oz/in (N/100mm)	Pads per Case	Handles per Case	Handle (W x L)	Tape Leg Length
ASTM Test Method			D-3652	D-3759	D-3330					
8310	10	Polypropylene	3.1 (0.079)	35 (613)	Synthetic Rubber	55 (60)	110	2750	1" x 17"	3"
8315	15	Polypropylene	3.2 (0.081)	35 (613)	Synthetic Rubber	55 (60)	80	2000	1-3/8" x 23"	6"
8320	20	Polyester	3.5 (0.089)	67 (1174)	Synthetic Rubber	78 (85)	110	2750	1" x 17"	3"
8330	30	Polyester	3.5 (0.089)	67 (1174)	Synthetic Rubber	78 (85)	80	2000	1-3/8" x 23"	6"
8340	40	Reinforced Strapping Tape	5.6 (0.142)	190 (3325)	Synthetic Rubber	67 (73)	80	2000	1-3/8" x 23"	6"
8350	50	Filament Tape	7.7 (0.196)	270 (4728)	Synthetic Rubber	80 (88)	80	2000	1-3/8" x 23"	6"

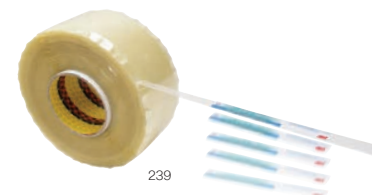

## In-line carry handles for automated application. Enables quick change over of marketing message.

Product	Weight Holding Capacity (lbs)	Tape Material	Adhesive Type	Adhesion oz/in (N/100mm)	Tensile Strength lb/in (N/100mm)	Total Thickness mils (mm)	Roll Type	Roll (W x L)	Core Dia.
8346	20	Polyester	Synthetic Rubber	31 (34)	70 (1220)	3.4 (0.086)	Level- wound	1" x 3280 yd	6"
8347	20	Polypropylene	Synthetic Rubber	50 (55)	103 (1800)	2.56 (0.065)	Level- wound	1" x 5470 yd	6"
8346HP	20	Polyester	Synthetic Rubber	52 (57.0)	67 (1174)	3.4 (0.086)	Level- wound	25mm x 3000m	6"



## Pre-laminated carry handles for automated application. Perfect for long runs with limited change overs.

Product	Weight Holding Capacity (lbs)	Handle Material	Adhesive Type/ Backing	Adhesion oz/in (N/100mm)	Tensile Strength lb/in (N/100mm)	Total Thickness mils (mm)	Roll Size/Format	Core Dia.	Suggested Use
8381	30	Multiple*	Synthetic Rubber/ MOPP	55 (60)	90 (1580)	2.8 (0.071)	MAX OD 380mm (15") Plantery or Level-wound Formats	6"	General purpose
8383	20	Multiple*	Synthetic Rubber/ MOPP	48 (53)	90 (1580)	2.8 (0.071)		6"	Apply on films
8393	20	Multiple*	Synthetic Rubber/ Polyester	50 (55)	50 (880)	2.8 (0.071)		6"	Apply on shrink wrap before tunnel

\*Available materials include: paper (2 grades), clear polyethylene, white polyethylene, polypropylene foam or polyethylene foam.

**Note:** This technical information and data should be considered representative or typical only and should not be used for specification purposes.

# Scotch® Multipack Tapes

## Economical and sustainable alternative to shrink films, banding, boxes and bags.

- Effective way to bundle consumer products into multipacks and value packs
- Clear, strong tape holds firmly and removes cleanly without damaging the primary package graphics
- Custom-print tape option delivers your branding and promotional messaging, as well as multipack barcoding



Marketing messages can be custom printed on this transparent, repositionable tape.

Discrete tape highlights primary packaging.

## A Full Selection of Bundling Options

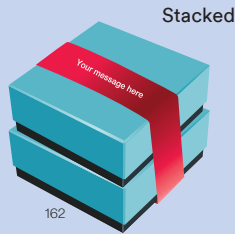

Upright

Custom carry handle option for convenience



Learn more about the Multipack Solution online. You'll find videos, and both tape and equipment details at [3M.com/Multipack](http://3M.com/Multipack)

Product	Color	Backing Material	Backing Thickness mils (mm)	Total Thickness mils (mm)	Tensile Strength lb/in (N/100mm)	Adhesive Type	Adhesion to Steel oz/in (N/100mm)	Elongation (%)	Comments
697	Clear	Polypropylene	1.6 (0.040)	1.9 (0.049)	23 (409)	Acrylic	4.78 (5.23)	77	Clean removal tape designed for multi-unit primary packaging; Apply manually or with automated equipment; 697CP is a custom printed version
697CP									
699	Clear	Polypropylene	1.6 (0.041)	2.6 (0.066)	30 (525)	Synthetic Rubber	46 (50)	160	Designed for bundling multi-unit primary packaging; Combine with 3M™ Carry Handles for bundling pouches; Apply manually or with automated equipment; 699CP is a custom printed version
699CP									

Note: This technical information and data should be considered representative or typical only and should not be used for specification purposes.





# Bag Sealing Tapes

## Stronger, faster, clearer than stitching closure for eye-popping woven polypropylene bags.

Featuring tough, transparent tapes that instantly seal a wide range of bag types and materials. Scotch® Bag Sealing Solutions can accelerate your entire end-of-line operation, while improving the visual impact of your packaging.

- Cut downtime and potentially double your throughput over traditional bag closing systems
- Improve bag appearance and enhance shelf appeal with woven polypropylene bags
- Eliminate the hassles of traditional mechanical stitchers and the messy glue pots that come with adhesive closure systems
- Give customers an easy-open alternative
- Reduce bag leakage and improve quality control

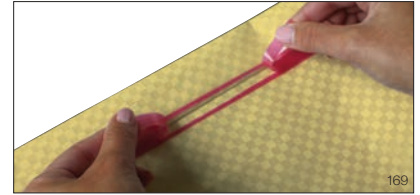

3M™ Transparent Film Tape 8470 with Scotch® Easy Open Tear Strip Tape 8622.



Custom printed tape for proof of factory seal.

Product	Color	Backing Material	Backing Thickness mils (mm)	Total Thickness mils (mm)	Tensile Strength lb/in (N/100mm)	Adhesive Type	Adhesion to Steel oz/in (N/100mm)	Elongation (%)	Comments
8469	Clear	Polyester	2.2 (0.051)	3.0 (0.076)	63 (1104)	Synthetic Rubber	75 (81)	130	Excellent tear, impact and abrasion resistance; 8469CP is a custom printed version
8469CP									
8470	Clear	Polypropylene	2.0 (0.051)	3.1 (0.079)	36 (615)	Synthetic Rubber	55 (60)	160	Good adhesion to variety of surfaces including polypropylene, paper, polyethylene; 8470CP is a custom printed version
8470CP									
8622	Red	Reinforced Polypropylene	8.4 (0.21)		190 (3320)	N/A No Functional Adhesive		30	Easy open feature when used with Scotch® Film Tape for heavy bag sealing

## 3M™ Tape Pads

### No dispenser? No problem!

- **Portable** “peel and stick” convenience, 25 sheets per pad
- **Adheres** to bags, boxes, plastic film, powder coats, metals and glass
- **Removable tab** for easy handling
- **Stores easily** in pockets, drawers, tool boxes and part carts
- **Used to repair, patch, seal, protect, reinforce, close and trap**



3M™ Packaging Tape Pad 3750P



3M™ Tape Sheets 822

Product	Sheet Size(s)	Color	Tape Material	Total Thickness mil (mm)	Tensile Strength lb/in (N/100mm)	Adhesive Type	Adhesion Strength oz/in (N/100mm)	Elongation (%)	Tab
809G	Custom Size	Transparent, Red, Yellow	Polypropylene	3.1 (0.079)	35 (613)	Synthetic Rubber	55 (60)	160	Removable or Permanent
809GP	Custom Size w/ Custom Print								
809S	Custom Size w/ Custom Backsheet	Transparent	Polypropylene	3.1 (0.079)	35 (613)	Synthetic Rubber	55 (60)	160	Removable or Permanent
822	4" x 6"	Transparent	Polypropylene	3.1 (0.079)	35 (613)	Synthetic Rubber	55 (60)	160	Removable
3750P	2" x 6"								

Note: This technical information and data should be considered representative or typical only and should not be used for specification purposes.

# Scotch® Bag Conveying Tape

- A high performance tape designed to convey a food grade preservation bag through the bag manufacturer's forming and packaging process
- Product constructions with or without reinforcement can meet a range of price/performance needs
- The pressure sensitive adhesive is specifically formulated to provide consistent adhesion to polyethylene

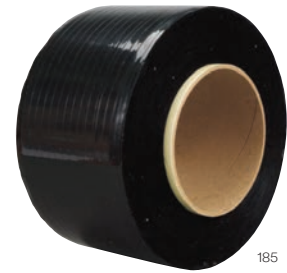

Product	Tensile Strength lb/in (N/100mm)	Backing Material	Reinforcement	Adhesive Type	Adhesion Strength oz/in (N/100mm)	Total Thickness mils (mm)	Elongation (%)	Color	Width(s)	Core Size
ASTM Test Method	D-3759				D-3330	D-3652				
8635	140 (2452)	Polyethylene	None	Synthetic Rubber	62 (68)	4.0 (0.102)	60%	Black	6mm 9mm	6 in

# 3M™ Hang Tabs

- Clear, durable, polyester tabs with a pressure-sensitive adhesive for easy in-store repair of damaged packaging such as torn punches in chipboard header cards
- Clear tabs do not obscure packaging graphics — showcases existing packaging graphics and messaging
- Pre-cut, bendable tab format for convenience and ease of use
- Sticks to most product or packaging surfaces for store display applications

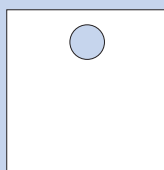
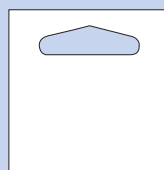

Hole Styles for Hang Tags		
 <p><b>J-Hook</b></p> <p>Consumer-friendly option, encourages item selection from anywhere on peg</p>	 <p><b>Round Hole</b></p> <p>For single-wire pegs</p>	 <p><b>Delta Hole</b></p> <p>For wider double-wire pegs or self-centers on standard pegs</p>



Product	Size (H x W)	Hole Style	Color	Hang Tabs per Pad	Backing Material	Total Thickness mil (mm)	Adhesive Type	Adhesion Strength oz/in (N/100mm)
1072	1-3/8" x 7/8"	J-Hook	Clear	Individual	Polyester	25.8 (0.66)	Synthetic Rubber	175 (192)
1074	1" x 2"	Round	Clear	10 per pad	Polyester	13.5 (0.34)	Synthetic Rubber	55 (60)
1075	2" x 2"	Delta	Clear	10 per pad	Polyester	13.5 (0.34)	Synthetic Rubber	55 (60)
1076	2" x 2"	Round	Clear	10 per pad	Polyester	13.5 (0.34)	Synthetic Rubber	55 (60)

Note: This technical information and data should be considered representative or typical only and should not be used for specification purposes.



# Scotch® Pouch Tapes

## Strong, low-profile attachment solution.

- “Trap it” with unique 3M tape construction — strong adhesive tape area on the edges frame the large, clear non-adhesive window area in the middle
- Attach documents, packing lists, invoices, literature, catalogs, brochures, or even product samples, small part packets or other merchandise
- Synthetic rubber adhesive sticks well to corrugate and many other substrates
- Custom-print option can personalize your message

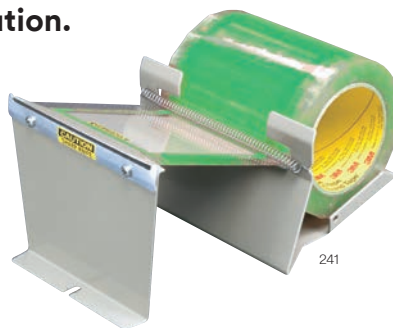

Scotch® Pouch Tape Dispenser M727 with Scotch® Pouch Tape 824RCT — Available in rolls for easy dispensing at pack stations.

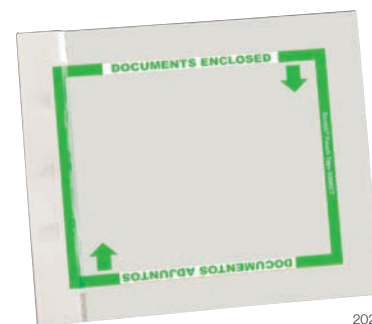

Scotch® Pouch Tape Sheets 830RCT are available in pads for portable back-pocket convenience. No liners help keep work areas clean of debris.

Product	Individual Pouch Size (h x w)	Printed Message	Applications	Core Size	Material Type	Total Thickness mils (mm)	Tensile Strength lb/in (N/100mm)	Adhesive Type	Adhesion Strength oz/in (N/100mm)	Dispenser Options
<b>Pads</b>										
830RCT	5" x 6" 6" x 10"	"Documents Enclosed"	25 per pad	—	Polypropylene	2.6 (0.066)	30 (525)	Synthetic Rubber	46 (50)	—
<b>Rolls</b>										
824RCT	5" x 6" 5" x 8" 6" x 10"	"Documents Enclosed"	500 per roll	3"	Polypropylene	2.6 (0.066)	30 (525)	Synthetic Rubber	46 (50)	M727 or M797

# Label Protection Tapes

## Protect labeled shippers, mailers, envelopes, tubes, drums, tubs.

- Tape material options for use on wide range of substrates
- High clarity for sharp read-through accuracy
- Bright color tape option draws attention to important label content



Product	Roll Width(s) Available	Roll Length	Color	Backing Material	Total Thickness mils (mm)	Tensile Strength lb/in (N/100mm)	Adhesive Type	Adhesion Strength oz/in (N/100mm)	Elongation (%)	Comments
821	2", 3", 4", 5", 6"	72 yd	Pink	Acetate	2.5 (0.063)	12 (210)	Acrylic	25 (27)	15	Low-glare matte finish. Write-on surface; Hand-tearable — no dispenser needed
856	1", 1.5", 2", 3", 4", 6"	72 yd	Clear	Polyester	2.0 (0.051)	25 (438)	Acrylic	20 (22)	90	Excellent transparency and resistance to abrasion, moisture and chemicals; Go-to option for outdoor applications
3565	96mm, 120mm	100m	Clear	Polypropylene	1.9 (0.048)	22 (385)	Synthetic Rubber	40 (44)	160	Excellent transparency and conformability; Resists tearing, splitting, moisture, abrasion and smudges
3765	96mm, 120mm, 144mm	132m	Clear	Polypropylene	1.5 (0.038)	20 (350)	Acrylic	22 (24)	119	Good transparency; Recommended for cold temperature applications

Note: This technical information and data should be considered representative or typical only and should not be used for specification purposes.

# 3M™ Packing List Envelopes

## Wide variety of choices for document control and protection.

- Convenient peel-and-stick document protection
- Non-printed and printed with standard messages
- Custom sizes and/or custom printed messages
- Reclosable 3M™ Zipper Closure Envelope is available in two sizes
- Polyethylene backing/synthetic rubber adhesive/paper liner
- Backing thickness: 2.0 mil;  
Total thickness: 5.0 mil



**Easy Inspection** — For cross border shipping and other inspection situations, zipper closure envelopes open easily and close securely. Tough construction resists moisture and abrasion.











**Secure Adhesion** — High tack pressure sensitive adhesive on the back of the envelope grabs on contact and holds securely even to curved and flexible surfaces.

### T (Top Printed)

<p><b>T1</b> Packing List/ Invoice Enclosed 4.5" x 5.5" 1,000/case</p>  <p style="writing-mode: vertical-rl; transform: rotate(180deg);">side-load</p>	<p><b>T1 INV</b> Invoice Enclosed 4.5" x 5.5" 1,000/case</p>  <p style="writing-mode: vertical-rl; transform: rotate(180deg);">side-load</p>	<p><b>T3</b> Packing List/ Invoice Enclosed 7" x 5.5" 1,000/case</p>  <p style="writing-mode: vertical-rl; transform: rotate(180deg);">top-load</p>
<p><b>T1 PL</b> Packing List Enclosed 4.5" x 5.5" 1,000/case</p>  <p style="writing-mode: vertical-rl; transform: rotate(180deg);">side-load</p>	<p><b>T2</b> Packing List/ Invoice Enclosed 4.5" x 6" 1,000/case</p>  <p style="writing-mode: vertical-rl; transform: rotate(180deg);">side-load</p>	<p><b>T4</b> Packing List/ Invoice Enclosed 5.5" x 10" 1,000/case</p>  <p style="writing-mode: vertical-rl; transform: rotate(180deg);">side-load</p>

### NP (Non-Printed)

<p><b>NP1</b> No Print (Clear) 4.5" x 5.5" 1,000/case</p>  <p style="writing-mode: vertical-rl; transform: rotate(180deg);">side-load</p>	<p><b>NP6</b> No Print (Clear) 9.5" x 12" 1,000/case</p>  <p style="writing-mode: vertical-rl; transform: rotate(180deg);">side-load</p>
<p><b>NP2</b> No Print (Clear) 4.5" x 6" 1,000/case</p>  <p style="writing-mode: vertical-rl; transform: rotate(180deg);">side-load</p>	<p><b>NP9</b> No Print (Clear) 7" x 6" 1,000/case</p>  <p style="writing-mode: vertical-rl; transform: rotate(180deg);">top-load</p>
<p><b>NP3</b> No Print (Clear) 5.5" x 7" 1,000/case</p>  <p style="writing-mode: vertical-rl; transform: rotate(180deg);">top-load</p>	<p><b>FED1</b> No Print (Perfed) 6.75" x 10.75" 500/case</p>  <p style="writing-mode: vertical-rl; transform: rotate(180deg);">top-load</p>
<p><b>NP4</b> No Print (Clear) 5.5" x 10" 1,000/case</p>  <p style="writing-mode: vertical-rl; transform: rotate(180deg);">side-load</p>	
<p><b>NP5</b> No Print (Clear) 7" x 10" 1,000/case</p>  <p style="writing-mode: vertical-rl; transform: rotate(180deg);">side-load</p>	

### F (Full Face Printed)

**F1**  
Packing List/  
Invoice Enclosed  
4.5" x 5.5"  
1,000/case



side-load

### Zipper Closure Envelopes

<p><b>NPZ-L</b> No Print (Clear) 8.5" x 11.5" 500/case</p>	<p><b>NPZ-XL</b> No Print (Clear) 10" x 12.5" 500/case</p>
--	--



side-load



# Remote Sensing Tapes

**3M retroreflective materials make it easy to design sensing systems based on simple, inexpensive photoelectric sensors. They increase readability, range and accuracy with greater control.**

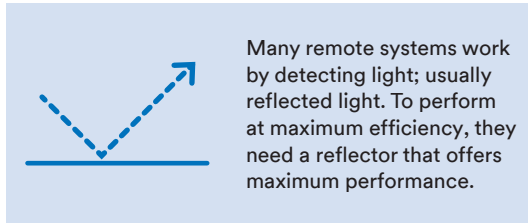

### 3M™ Prismatic Remote Sensing Target 3000X

- Micro-cube corner sheeting made of a flexible synthetic resin which will perform well with polarized light
- Smooth, clear surface can be cleaned easily
- Aggressive pressure sensitive adhesive provides an excellent bond to most clean, wax-free, dry, relatively non-porous, weather resistant surfaces
- Adhesive is protected by a liner which is removed at the time of application and the reflector is pressed into position

### Scotch® Photoelectric Scanning Tape 7800

- Exposed-lens retroreflective tape with a pressure-sensitive adhesive that is designed for use as expendable code marks in automatic warehouse or conveyor operations
- This product affords exceptional contrast with its background for increased accuracy, reliability, and depth-of-field in photoelectric sorting and classification systems and may be employed with automatic on-line applicators or manual dispensers for identification or simple sortation of paperboard shipping containers

### 3M™ Scotchlite™ Photoelectric Grade Smooth Surface Sheeting 7590

- Durable, flexible, wide angle, smooth-surface, retroreflective sheeting, specially designed for use in photoelectric applications such as retroreflective labels or marks
- Sheeting consists of special lens elements enclosed within a transparent resin, having a smooth flat outer surface and is supplied with a low-temperature, pressure-sensitive adhesive protected by a removable liner

### 3M™ Scotchlite™ High Gain Reflective Sheeting 7610

- High gain reflective industrial grade sheeting, exposed-lens, retroreflective, plastic-based material, pre-coated with a pressure-sensitive adhesive
- Adhesive is covered with a removable protective liner that offers a very high retroreflective efficiency and small optical elements

Product	Tape Structure (Backing/Adhesive)	Liner	Format	Typical Luminance Factor		Thickness – Applied (in.)	Temperature Resistance – Intermittent °F (°C)	Lens	Color
				-4 deg.	45 deg.				
3000X	Micro-cube corner sheeting/ acrylic adhesive/paper liner	Yes	Sheets and Rolls	1000x	1500x	0.020	150 (65.5)	Protected	White with linear pattern
7590	Sealed reflective tape/ low temperature synthetic resin/liner	Yes	Rolls	200x	80x	0.007	400 (204)	Protected	Opaque White
7610	Exposed reflective tape/ synthetic resin/liner	Yes	Rolls	900x	700x	0.004	250 (121)	Exposed	Light Gray
7800	Exposed-lens reflective tape/ synthetic resin/linerless	No	Rolls	200x	100x	0.007	500 (260)	Exposed	Medium Gray

**Note:** This technical information and data should be considered representative or typical only and should not be used for specification purposes.

# Scotch® Tear Strip Tape

## Easy access with a simple pull.

For easy opening of packages ranging from overnight envelopes to corrugated fiberboard, the recipient simply grabs and pulls the exposed end of a Scotch® Tear Strip Tape.

- Tensilized polypropylene tears through paper board and light to heavy weight fiber board with high pull-rate success
- Eliminates knives or other sharp edges from opening envelopes and panels
- High pull rate for light to medium weight fiberboard such as CD and book mailers



184

Product	Backing Material	Reinforcement	Adhesive Type	Tensile Strength lb/in (N/100mm)	Total Thickness mils (mm)	Adhesion Strength oz/in (N/100mm)	Elongation (%)	Color	Comments
<b>ASTM Test Method</b>				<b>D-3759</b>	<b>D-3652</b>	<b>D-3330</b>			
<b>8624</b>	Polypropylene	None	Synthetic Rubber	160 (2802)	4.5 (0.114)	65 (71)	30	Blue	Medium-strength tear strip for light- to medium-weight fiberboard packaging materials



245

244

Note: This technical information and data should be considered representative or typical only and should not be used for specification purposes.



# Glossary

This glossary is compiled by the Pressure Sensitive Tape Council (PSTC) and 3M (terms identified with an asterisk). PSTC is the North American trade association for tape manufacturers and affiliate suppliers, dedicated to helping the industry produce quality pressure sensitive adhesive tape products in the global marketplace. Visit [pstc.org](http://pstc.org) for more information.

## **Abrasion Resistance**

The ability of a tape to withstand rubbing and still function satisfactorily.

## **Acrylic Adhesive\***

A pressure sensitive, viscoelastic blend of acrylic-based materials which may be modified by tackifying additives. Acrylic adhesives are a very broad class of materials and come in many types to achieve different properties.

## **Adhesion to Backing**

The bond produced to the backing of the same tape or another tape backing.

## **Adhesive Deposit or Residue**

Adhesive that is pulled away from the tape upon removal and remains on the surface to which it has been applied.

## **Adjustable Case Sealer**

A case sealer that must be manually adjusted for box width and height. Accepts runs of one box size at a time.

## **Article Letters\***

Letters if a MSDS does not exist on a product.

## **Backing**

A relatively thin flexible material to which the adhesive is applied. Theoretically, any material that is reasonably flat, thin and flexible can be used as a tape backing.

## **Backsize**

An occlusive coating applied to the non-pressure sensitive side of a porous backing, such as paper, in order to provide a satisfactory surface that the pressure sensitive adhesive side can contact when the tape is wound into a roll.

## **Caliper**

The thickness (as of a sheet of paper) measured under specified conditions. See also THICKNESS.

## **Co-extruded\***

Refers to film extruded in individual layers with the possibility of different raw materials in each layer providing unique combined film properties.

## **Conformability\***

The ability for a tape to make arcs, circles, go into depressions, go over protrusions and still stay in one piece without slivering or tape lifting or necking down.

## **Containment**

To confine and hold in place.

## **Controlled Unwind\***

When a balance is achieved between too low of an unwind, allowing the tape to prematurely unwind from its own backing, or too high, causing premature slivering or breaking when unwinding from its roll.

## **Elastomer**

An elastic, polymeric substance, such as natural or synthetic rubber.

## **Elongation (Stretch, Ultimate Elongation)**

The distance a tape will stretch in the machine or cross direction before breaking under controlled conditions, expressed as a percentage of original length. Elongation is not necessarily an indication of conformability.

## **Extruded\***

A manufacturing process where material is forced through a nozzle (like extruded film or backing). Better for lay-flat than skived.

## **FOL**

Full overlap.

## **Filaments**

Thin, longitudinal yarns or threads of glass, polyester, nylon or other high strength materials.

## **Holding Power (Shear Adhesion, Shear Resistance)**

The ability of a tape to resist static forces applied in the same plane as the backing. Usually expressed in a time required for a given weight and length of tape to shear free from a vertical panel.

## **Hot Melt (Pressure Sensitive Adhesive)**

A pressure sensitive adhesive, applied to the backing in hot liquid form, which then cools to form a conventional pressure sensitive adhesive.

## **Humidity**

The moisture content of the air. Actual humidity is the number of grams of moisture in the air at any given time. Relative humidity is the percent of moisture relative to the maximum that air at any given temperature can retain without precipitation.

## **Impact Resistance (Shock Resistance)**

The ability of a tape to resist sudden impacts, pulls, or shocks as may sometimes be encountered by packages in transit.

## **L-Clip**

Tape seal applied over the edge of non-RSCs with one leg down the side and the other on the top and/or bottom.

## **Moisture Vapor Transmission Rate**

A measure of the rate of water vapor transmission through a pressure sensitive product usually measured in grams per square meter per 24 hours.

## **MOPP**

Monoaxially-oriented polypropylene tape construction.

## **NPE\***

An NPE number is used to designate an experimental product. NPE products are often provided to customers for evaluation purposes only, and may or may not be commercialized.

## **Non-RCS**

All box structures other than RSC (Regular Slotted Carton).

## **Off-Core**

A roll of tape in which the layers are in correct alignment, but the tape is displaced sideways on the core.

## **Opacity**

The ability of a tape to prevent the transmission of light.

## **Pad**

Pre-cut, tape strips stacked on a pad for easy one-at-a-time removal.

\*Compiled by 3M.

# Glossary

## **PE\***

The abbreviation for polyethylene. Usually extruded in a single (mono) layer.

## **Peel Adhesion**

The force per unit width required to break the bond between a pressure sensitive adhesive tape and the surface to which it has been applied when the tape is peeled back at a controlled angle at a standard rate and condition.

## **PLE**

Packing List Envelope.

## **Pouch Tape**

Tape with adhesive-free area within a perimeter of pressure sensitive adhesive. When applied the adhesive-free area forms a containment pouch.

## **PP\***

Abbreviation for polypropylene. Usually manufactured as a single (mono) layer via a casting process.

## **Pressure Sensitive**

A term commonly used to designate a distinct category of adhesive tapes and adhesives which in dry form (solvent/water free) are aggressively and permanently tacky at room temperature and that firmly adhere to a variety of dissimilar surfaces upon mere contact without the need of more than finger or hand pressure. These products require no activation by water, solvent, or heat in order to exert a strong adhesive holding force toward such materials as paper, plastic, glass, wood, cement, and metal. They have sufficient cohesive holding power and elastic nature so that, despite their aggressive tackiness, they can be handled with the fingers and removed from smooth surfaces without leaving a residue.

## **Quick Stick (Finger Tack, Initial Adhesion, Wet Grab)**

See TACK.

## **Random Case Sealer**

A case sealer that automatically adjusts for case width and height. Typically used for runs of different box sizes.

## **Recouperage**

To salvage goods within a container that has broken or opened during shipment.

## **Release Force**

The measure of the force required to separate a unit width of pressure sensitive tape from a release coated surface at a controlled angle and speed.

## **Remote Sensing**

The technique or process of obtaining data or images from a distance.

## **Retroreflective**

Surface, material, or device that reflects light back to its source.

## **RGT**

Reinforced Gum Tape.

## **RSC**

Regular Slotted Carton.

## **Rubber Adhesive\***

A pressure sensitive, viscoelastic blend of polymeric rubber-based materials and tackifying resin. The rubber materials may be natural or synthetic. Rubber adhesives are a very broad class of materials and come in many types to achieve different properties.

## **Shear Adhesion**

The time required, under specified test conditions (surface area, weight load), to slide a standard area of pressure sensitive tape from a standard flat surface in a direction parallel to the surface.

## **Single Faced (Coated)**

A tape to which a pressure sensitive adhesive is applied to only one side of the backing.

## **Solvent/Chemical Resistant\***

Ability to resist common solvents or chemicals.

## **Surface Energy (Surface Wetting Ability)**

The measure of surface tension in dynes. The lower the surface energy of a substrate, the more difficult it becomes for an adhesive or coating to wet out that surface.

## **Tack**

The property of a pressure sensitive adhesive that allows it to adhere to a surface under very slight pressure. It is determined by the ability of the adhesive to wet quickly the surface it contacts.

## **Tear Resistance**

The force required to propagate a tear in a tape in a given direction after the tear has been initiated.

## **Telescoping**

A sideways sliding of the tape layers, one over another, such that the roll looks like a funnel or a telescope, usually occurring over a period of time.

## **Tensile Strength**

The force required to break a unit width of tape by controlled pulling on opposite ends of the piece.

## **Thickness (Caliper, Gauge)**

The perpendicular distance from one surface of either a tape, backing or adhesive to the other, usually expressed in mils, thousandths of an inch or millimeters. This is usually measured under controlled slight pressure with a special gauge.

## **TSCA\***

Toxic Substances Control Act.

## **U-Clip**

Tape seal applied to an RSC carton with tape legs down both sides of the carton and across the center seam.

## **UL 723\***

UL 723 deals mainly with flammability.

## **Unwind or Unwind Adhesion**

The force required to remove tape from a roll under prescribed conditions.

## **Water Vapor Transmission (WVTR)**

The weight of water vapor allowed through a controlled area of tape within a specified time period and under controlled conditions.

\*Compiled by 3M.





# Numerical Index

200a	8	864	33	7800	43	H122	16
200a3	8	865	33	8000a	9	H123	16
302	21	880	29, 31	8000a3	9	H128	16
305	21	880MSR	31	8000af	9	H129	16
311+	21, 22, 24	890MSR	29, 31	8000af3	9	H130	16
313	21	890RCT	31	8004	27	H131	16
315	21	893	29, 31	8310	37	H133	16
351	21	894	31	8315	37	H150	16
353	21	896	31	8320	37	H153	16
355	21	897	29, 31	8330	37	H180	16
355CP	23	898	29, 31	8340	37	H183	16
369	21	898MSR	31	8346	37	H190	16
371	21	899	31	8346HP	37	H192	16
371+	21, 22	1072	40	8347	37	H320	16
371CP	23	1074	40	8350	37	HB900	16
373	21	1075	40	8381	37	HB901	16
373CP	23	1076	40	8383	37	HB902	16
375	21	2517	25	8393	37	HB903	16
375CP	23	2519	25	8469	39	HR80	16
600	27	2525	25	8469CP	39	HR83	16
605	27	2526	25	8470	39	HR933	16
610	27	3000X	43	8470CP	39	M82	16
640	27	3071CP	23	8622	39	M96	16
660	27	3073	22	8624	44	M707	16
681	27	3073CP	23	8635	40	M727	16
690	27	3199	25	8651	33	M797	16
697	38	3565	41	8884	34	M900	16
697CP	38	3732	25	8886	34	M920	16
699	38	3750P	39	8898	32	P52	16
699CP	38	3765	41	8899HP	29, 32	P52W	16
700a-s	8	3771	25	8915	31	P56	16
800ab	9	3772	25	8916V	31	P56W	16
800ab3	9	3775	25	8919MSR	31	P400	16
800asb	9	3779	25	8934	29, 31	P448	16
800r	10	5910	27	8959	31	S634	16
800r3	10	6141	25	8988	31	S867	12
800rf	10	6142	25	a20	8	S86711	12
800rf3	10	6143	25	a20-s	8	W100	16
800rks	10	6144	25	a80	9	W200	16
809G	39	6145	25	a80-3	9		
809GP	39	6146	25	a80-t	9		
809S	39	6147	25	a80b	9		
824RCT	41	7000a Pro	8	a80b-3	9		
830RCT	41	7000a3 Pro	8	C22	16		
821	41	7000r HS Pro	10	C23	16		
822	39	7000r Pro	10	C25	16		
856	27, 41	7000r3 HS Pro	10	H10	16		
860	29, 32	7000r3 Pro	10	H12	16		
862	29, 33	7590	43	H38	16		
863	33	7610	43	H121	16		

# Product Name Index

## 3M™ AccuGlide™ Taping Heads

2+ .....	11
3 .....	11
4 .....	11
HST .....	11
LHB .....	11
NPH .....	11

## 3M-Matic™ Adjustable Case Sealers

200a .....	8
200a3 .....	8
7000a Pro .....	8
7000a3 Pro .....	8
700a-s .....	8
8000a .....	9
8000a3 .....	9
8000af .....	9
8000af3 .....	9
800ab .....	9
800ab3 .....	9
800asb .....	9
a20 .....	8
a20-s .....	8
a80 .....	9
a80-3 .....	9
a80-t .....	9
a80b .....	9
a80b-3 .....	9

## 3M-Matic™ Random Case Sealers

800r .....	10
800r3 .....	10
800rf .....	10
800rf3 .....	10
800rks .....	10
7000r HS Pro .....	10
7000r Pro .....	10
7000r3 HS Pro .....	10
7000r3 Pro .....	10

## Bag Conveying Tape

8635 .....	40
------------	----

## Bag Sealing Tapes

8469 .....	39
8469CP .....	39
8470 .....	39
8470CP .....	39
8622 .....	39

## Box Repair Tapes

2517 .....	25
2519 .....	25
2525 .....	25
2526 .....	25

## Box Sealing Tapes

311+ .....	21
302 .....	21
305 .....	21
313 .....	21
315 .....	21
351 .....	21
353 .....	21
355 .....	21
369 .....	21
371 .....	21
371+ .....	21
373 .....	21
375 .....	21

## Carry Handles

8310 .....	37
8315 .....	37
8320 .....	37
8330 .....	37
8340 .....	37
8346 .....	37
8346HP .....	37
8347 .....	37
8350 .....	37
8381 .....	37
8383 .....	37
8393 .....	37

## Cold Temperature Tape

311+ .....	24
------------	----

## Custom Printed Box Sealing Tapes

355CP .....	23
371CP .....	23
373CP .....	23
375CP .....	23
3071CP .....	23
3073CP .....	23

## Fingerprint Lifting Tape

8004 .....	27
------------	----

## Hang Tabs

1072 .....	40
1074 .....	40
1075 .....	40
1076 .....	40

## High Strength Filament Tapes

860 .....	29
862 .....	29
880 .....	29, 31
880MSR .....	31
890MSR .....	29, 31
890RCT .....	31
893 .....	29, 31
894 .....	31
896 .....	31
897 .....	29, 31
898 .....	29, 31
898MSR .....	31
899 .....	31
8899HP .....	29
8915 .....	31
8934 .....	29, 31
8959 .....	31
8988 .....	31
8916V .....	31
8919MSR .....	31

## Label Protection Tapes

821 .....	41
856 .....	41
3565 .....	41
3765 .....	41

## Light Duty Packaging Tapes

600 .....	27
605 .....	27
610 .....	27
640 .....	27
660 .....	27
681 .....	27
690 .....	27
856 .....	27
5910 .....	27



# Product Name Index

## Manual Tape Dispensers

C22	16
C23	16
C25	16
H10	16
H12	16
H38	16
H121	16
H122	16
H123	16
H128	16
H129	16
H130	16
H131	16
H133	16
H150	16
H153	16
H180	16
H183	16
H190	16
H192	16
H320	16
HB900	16
HB901	16
HB902	16
HB903	16
HR80	16
HR83	16
HR933	16
M82	16
M96	16
M707	16
M727	16
M797	16
M900	16
M920	16
P52	16
P52W	16
P56	16
P56W	16
P400	16
P448	16
S634	16
W100	16
W200	16

## Multipack Tapes

697	38
697CP	38
699	38
699CP	38

## Non-RSC Closure Solutions

S867	12
S867II	12

## Packing List Envelopes

F1	43
FED1	43
NP1	43
NP2	43
NP3	43
NP4	43
NP5	43
NP6	43
NP9	43
NPZ-L	43
NPZ-XL	43
T1	43
T1 INV	43
T1 PL	43
T2	43
T3	43
T4	43

## Pouch Tapes

824RCT	41
830RCT	41

## Recycled Corrugate Tapes

311+	22
371+	22
3073	22

## Reinforced Strapping Tapes

862	29, 33
863	33
864	33
865	33
8651	33

## Remote Sensing Tapes

3000X	43
7590	43
7610	43
7800	43

## Security Tapes

3199	25
3732	25
3771	25
3772	25
3775	25
3779	25

## Stretchable Tapes

8884	34
8886	34

## Tape Pads

809G	39
809GP	39
809S	39
822	39
3750P	39

## Tear Strip Tape

8624	44
------	----

## Tensitized Polypropylene Tapes

860	29, 32
8898	32
8899HP	29, 32

## Water Activated Tapes

6141	25
6142	25
6143	25
6144	25
6145	25
6146	25
6147	25

# We're here to help.

Need help finding the right product for your packaging needs? Contact us if you need product, technical or application advice or want to collaborate with a 3M technical specialist, or give us a call at 1-800-831-0658.

**3M Custom Packaging Hotline: 1-800-253-2329**

**3M Industrial Technical Support: 1-888-726-8244**

**3M-Matic™ Application Support Helpline: 1-800-328-1390**

**3M-Matic™ and Tape Dispenser Replacement Parts: 1-800-344-9883**

**Product Selection and Use:** Many factors beyond 3M's control and uniquely within user's knowledge and control can affect the use and performance of a 3M product in a particular application. As a result, customer is solely responsible for evaluating the product and determining whether it is appropriate and suitable for customer's application, including conducting a workplace hazard assessment and reviewing all applicable regulations and standards (e.g., OSHA, ANSI, etc.). Failure to properly evaluate, select, and use a 3M product and appropriate safety products, or to meet all applicable safety regulations, may result in injury, sickness, death, and/or harm to property.

**Warranty, Limited Remedy, and Disclaimer:** Unless a different warranty is specifically stated on the applicable 3M product packaging or product literature (in which case such warranty governs), 3M warrants that each 3M product meets the applicable 3M product specification at the time 3M ships the product. 3M MAKES NO OTHER WARRANTIES OR CONDITIONS, EXPRESS OR IMPLIED, INCLUDING, BUT NOT LIMITED TO, ANY IMPLIED WARRANTY OR CONDITION OF MERCHANTABILITY, FITNESS FOR A PARTICULAR PURPOSE, OR ARISING OUT OF A COURSE OF DEALING, CUSTOM, OR USAGE OF TRADE. If a 3M product does not conform to this warranty, then the sole and exclusive remedy is, at 3M's option, replacement of the 3M product or refund of the purchase price.

**Limitation of Liability:** Except for the limited remedy stated above, and except to the extent prohibited by law, 3M will not be liable for any loss or damage arising from or related to the 3M product, whether direct, indirect, special, incidental, or consequential (including, but not limited to, lost profits or business opportunity), regardless of the legal or equitable theory asserted, including, but not limited to, warranty, contract, negligence, or strict liability.

3M, 3M-Matic, AccuGlide, Scotchlite and Tartan are trademarks of 3M Company. Scotch is a registered trademark of 3M Company.



**Closure and Masking Systems Division**  
**3M Center, Building 225-3S-06**  
**St. Paul, MN 55144-1000**

**Phone** 800-362-3550  
**Fax** 877-369-2923  
**Web** 3M.com/Packaging

Please recycle. Printed in USA.  
© 3M 2019. All rights reserved.  
70-0710-0432-2 Rev Apr 2019

## X-ON Electronics

Largest Supplier of Electrical and Electronic Components

*Click to view similar products for [Adhesive Tapes](#) category:*

*Click to view products by [3M](#) manufacturer:*

Other Similar products are found below :

[56-YELLOW-34"X72YD](#) [00-021200-13972-7](#) [021200-64630](#) [60 TAPE \(1"\)](#) [62-GRAY-12"X36YD](#) [62-GRAY-1"X36YD](#) [69-1"X36YD](#) [764-1"x36yd-Red](#) [764-1"x36yd-White](#) [9500PC-3/4](#) [967454-1](#) [1181 19MM X 16,5 METERS](#) [130C-1X15FT](#) [E39-RS1-CA](#) [1900-48mm](#) [22-1/2X36YD](#) [88-SUPER-34X44FT](#) [890103N001](#) [2670](#) [96](#) [EVK-TA-TM047NBH01](#) [20-1"X60YDS](#) [2020-18mmx55m](#) [H150](#) [363](#) [3900-Blue](#) [3939-24mmx55m](#) [44-TAN-14"X90YD](#) [4504-34x18](#) [471-Trans-1"x36yd-Bulk](#) [5414 34X36](#) [35-Gray-1/2](#) [4008-12"X36YD](#) [4104-34"x18yd](#) [4116](#) [444-1"x36yd](#) [4466 1"](#) [4466W-1/2"x36yd](#) [4492B-12"x72yd](#) [4492B-1"x72yd](#) [4496W-12"x36yd](#) [4508-1"x36yd](#) [4516-3/8x36](#) [4726](#) [1/2"X36YD](#) [054007-43154](#) [054007-43152](#) [06149](#) [11-32-2857](#) [5419 1/2"](#) [56 TAPE \(1/2"\)](#)