

### Features

- Supply Voltage: 3V to 36V
- Differential Input Voltage Range to Supply Rail
- Input Rail to  $-V_s$ , Rail to Rail Output
- Fast Response: 10 MHz Bandwidth, 8V/ $\mu$ s Slew Rate, 100ns Overload Recovery
- Low Offset Voltage:
  - ±3mV Maximum at 25°C,
  - ±3.5mV Maximum at -40°C to 85°C
  - ±4mV Maximum at -40°C to 125°C
- Very Low THD+N: 0.0007% at Gain = 1, 20kHz
- Excellent EMIRR: 58dB at 900MHz
- 2KV HBM, 1KV CDM, 150mA Latch Up
- -40°C to 125°C Operation Temperature Range

### Applications

- Audio
- Sensor Interface
- Motor Control

### Description

The TP258X series amplifiers are newest high supply voltage amplifiers with low offset, low power and stable high frequency response. They incorporate 3PEAK's proprietary and patented design techniques to achieve very good AC performance with 10MHz bandwidth, 8V/ $\mu$ s slew rate, and 100ns overload recovery time while drawing only 3mA of quiescent current per amplifier; the TP258X family achieve the best THD+N performance in audio signal range, it's the ideal choices for motor control and audio amplification.

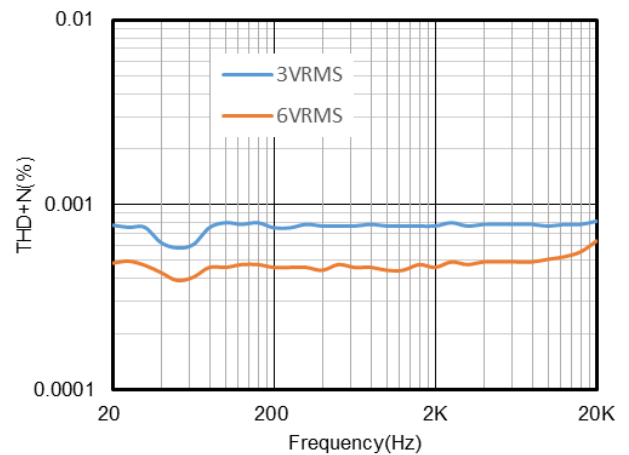

### Pin Configuration

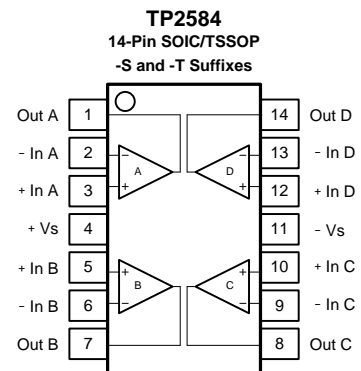
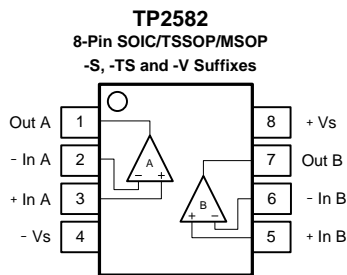
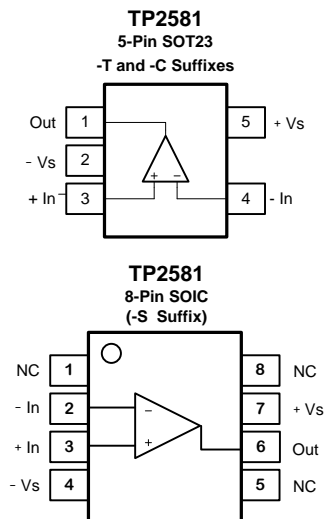

## Table of Contents

Features .....	1
Applications.....	1
Description.....	1
Pin Configuration .....	1
Table of Contents .....	2
Revision History .....	2
Order Information.....	3
Absolute Maximum Ratings <sup>Note 1</sup> .....	4
ESD Rating.....	4
Thermal Information .....	4
Electrical Characteristics .....	5
Typical Performance Characteristics .....	7
Tape and Reel Information .....	10
Package Outline Dimensions.....	11
SOT23-5.....	11
SOIC-8 .....	11
TSSOP-8.....	12
MSOP-8 .....	12
SOIC-14 .....	13
TSSOP-14.....	13

## Revision History

Date	Revision	Notes
2018/7/21	Rev.Pre	Pre-Release Version
2019/3/1	Rev.0	Initial Version
2019/10/23	Rev.0.01	Add new product: TP2581-TR
2019/12/6	Rev.0.02	Update Iq Spec of TP2581
2020/4/25	Rev.A	Add Figure: PSRR vs. Freq, CMRR vs. Freq
2020/7/21	Rev.A.1	Update Figure: PSRR vs. Freq
2020/9/24	Rev.A.2	Update the description of Absolute Maximum Ratings: "Maximum Junction Temperature" -> "Maximum Operating Junction Temperature"

## Order Information

Order Number	Operating Temperature Range	Package	Marking Information	MSL	Transport Media, Quantity
TP2581-SR <sup>Note 2</sup>	-40 to 125°C	8-Pin SOIC	2581 XXXX <sup>Note 1</sup>	3	Tape and Reel, 4000
TP2581-TR	-40 to 125°C	5-Pin SOT23	258XX <sup>Note 1</sup>	3	Tape and Reel, 3000
TP2582-SR	-40 to 125°C	8-Pin SOIC	2582 XXXX <sup>Note 1</sup>	3	Tape and Reel, 4000
TP2582-TSR	-40 to 125°C	8-Pin TSSOP	2582 XXXX <sup>Note 1</sup>	3	Tape and Reel, 3000
TP2582-VR	-40 to 125°C	8-Pin MSOP	2582 XXXX <sup>Note 1</sup>	3	Tape and Reel, 3000
TP2584-SR	-40 to 125°C	14-Pin SOIC	2584 XXXX <sup>Note 1</sup>	3	Tape and Reel, 2500
TP2584-TR	-40 to 125°C	14-Pin TSSOP	2584 XXXX <sup>Note 1</sup>	3	Tape and Reel, 3000

Note 1: "XXXX" and "XX" identify the manufacture site and date code information.

Note 2: The sample will be ready in 1 month.

## Absolute Maximum Ratings <sup>Note 1</sup>

Parameters	Rating
Supply Voltage, (+V <sub>S</sub> )– (-V <sub>S</sub> )	40 V
Input Voltage	(-V <sub>S</sub> ) – 0.3 to (+V <sub>S</sub> ) + 0.3
Differential Input Voltage	(+V <sub>S</sub> ) - (-V <sub>S</sub> )
Input Current: +IN, –IN <sup>Note 2</sup>	±10mA
Output Short-Circuit Duration <sup>Note 3</sup>	Infinite
Maximum Operating Junction Temperature	150°C
Operating Temperature Range	–40 to 125°C
Storage Temperature Range	–65 to 150°C
Lead Temperature (Soldering, 10 sec)	260°C

Note 1: Stresses beyond those listed under Absolute Maximum Ratings may cause permanent damage to the device. Exposure to any Absolute Maximum Rating condition for extended periods may affect device reliability and lifetime.

Note 2: The inputs are protected by ESD protection diodes to each power supply. If the input extends more than 300mV beyond the power supply, the input current should be limited to less than 10mA.

Note 3: A heat sink may be required to keep the junction temperature below the absolute maximum. This depends on the power supply voltage and how many amplifiers are shorted. Thermal resistance varies with the amount of PC board metal connected to the package. The specified values are for short traces connected to the leads.

## ESD Rating

Symbol	Parameter	Condition	Minimum Level	Unit
HBM	Human Body Model ESD	ANSI/ESDA/JEDEC JS-001	2	kV
CDM	Charged Device Model ESD	ANSI/ESDA/JEDEC JS-002	1	kV

## Thermal Information

Package Type	θ <sub>JA</sub>	θ <sub>JC</sub>	Unit
5-Pin SOT23	250	81	°C/W
8-Pin SOIC	158	43	°C/W
8-Pin TSSOP	191	44	°C/W
8-Pin MSOP	210	45	°C/W
14-Pin SOIC	120	36	°C/W
14-Pin TSSOP	180	35	°C/W

## Electrical Characteristics

All test condition is  $V_S = 30V$ ,  $T_A = 25^\circ C$ ,  $R_L = 10k\Omega$ , unless otherwise noted.

Symbol	Parameter	Conditions	$T_A$	Min	Typ	Max	Unit
<b>Power Supply</b>							
$V_S$	Supply Voltage Range			3		36	V
$I_Q$	Quiescent Current per Amplifier	$V_S = 30V$ , TP2581			4.2	5.4	mA
			-40°C to 125°C			5.9	mA
		$V_S = 5V$ , TP2581			3.5	4.9	mA
			-40°C to 125°C			5.2	mA
		$V_S = 30V$ , TP2582/TP2584			3	4	mA
			-40°C to 125°C			4.5	mA
$V_S = 5V$ , TP2582/TP2584			2.5	3.75	mA		
	-40°C to 125°C			4	mA		
PSRR	Power Supply Rejection Ratio	$V_S = 3V$ to 36V		95	120		dB
			-40°C to 125°C	90			dB
<b>Input Characteristics</b>							
$V_{OS}$	Input Offset Voltage	$V_S = 30V$ , $V_{CM} = 0V$ to 28.5V		-3	0.1	3	mV
			-40°C to 85°C	-3.5		3.5	mV
			-40°C to 125°C	-4		4	mV
		$V_S = 5V$ , $V_{CM} = 2.5V$		-3	0.1	3	mV
			-40°C to 125°C	-4		4	mV
$V_{OS\ TC}$	Input Offset Voltage Drift		-40°C to 125°C		2		μV/°C
$I_B$	Input Bias Current				25		pA
			-40°C to 85°C		80		pA
			-40°C to 125°C		1000		pA
$I_{OS}$	Input Offset Current				25		pA
$I_{IN}$	Different Input Current	$V_S = 36V$ , $V_{ID} = 36V$			10		nA
			-40°C to 125°C			100	
$C_{IN}$	Input Capacitance	Differential Mode			5		pF
		Common Mode			2.5		pF
$A_v$	Open-loop Voltage Gain			105	120		dB
			-40°C to 125°C	95			dB
$V_{CMR}$	Common-mode Input Voltage Range			(V-)		(V+) – 1.5	V
CMRR	Common Mode Rejection Ratio	$V_{CM} = 0V$ to 28V		105	130		dB
			-40°C to 125°C	100			dB

Output Characteristics							
V <sub>OH</sub>	Output Swing from Positive Rail	R <sub>LOAD</sub> = 10kΩ to V <sub>S</sub> /2			0.4	0.7	V
			-40°C to 125°C			1.2	V
		R <sub>LOAD</sub> = 2kΩ to V <sub>S</sub> /2			1.3	1.7	V
			-40°C to 125°C			2.5	V
V <sub>OL</sub>	Output Swing from Negative Rail	R <sub>LOAD</sub> = 10kΩ to V <sub>S</sub> /2			0.2	0.5	V
			-40°C to 125°C			1	V
		R <sub>LOAD</sub> = 2kΩ to V <sub>S</sub> /2			0.8	1.2	V
			-40°C to 125°C			2	V
I <sub>SC</sub>	Output Short-Circuit Current			25	32		mA
		-40°C to 85°C	20				mA
		-40°C to 125°C	15				mA
AC Specifications							
GBW	Gain-Bandwidth Product				10		MHz
SR	Slew Rate	G = 1, 10V step			8		V/μs
		Open Loop		6.5	8		V/μs
			-40°C to 125°C	5.5			V/μs
t <sub>OR</sub>	Overload Recovery				100		ns
t <sub>S</sub>	Settling Time, 0.1%	G = 11, 2.5V step			0.8		μs
	Settling Time, 0.01%				1		μs
PM	Phase Margin	V <sub>S</sub> = 36V, R <sub>L</sub> =10K, C <sub>L</sub> =100pF			60		°
GM	Gain Margin	V <sub>S</sub> = 36V, R <sub>L</sub> =10K, C <sub>L</sub> =100pF			15		dB
Noise Performance							
E <sub>N</sub>	Input Voltage Noise	f = 0.1Hz to 10Hz			1.2		μV <sub>RMS</sub>
e <sub>N</sub>	Input Voltage Noise Density	f = 1kHz			35		nV/√Hz
		f = 10kHz			17		nV/√Hz
i <sub>N</sub>	Input Current Noise	f = 1kHz			2		fA/√Hz
THD+N	Total Harmonic Distortion and Noise	f = 1kHz, G = 1, R <sub>L</sub> = 10kΩ, V <sub>OUT</sub> = 6V <sub>RMS</sub>			0.0005		%

## Typical Performance Characteristics

$V_s = \pm 15V$ ,  $V_{CM} = 0V$ ,  $R_L = 10k\Omega$ , unless otherwise specified.

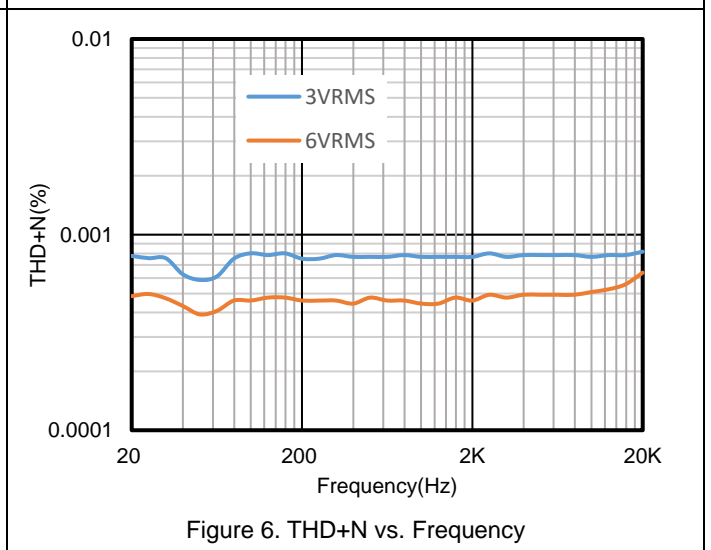
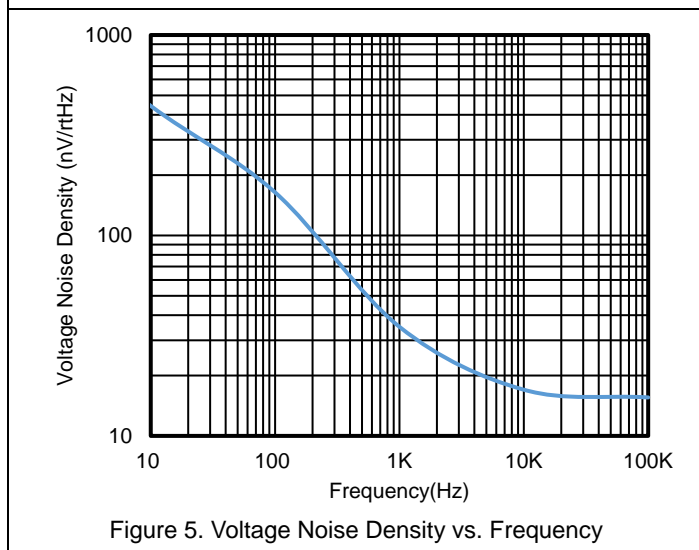
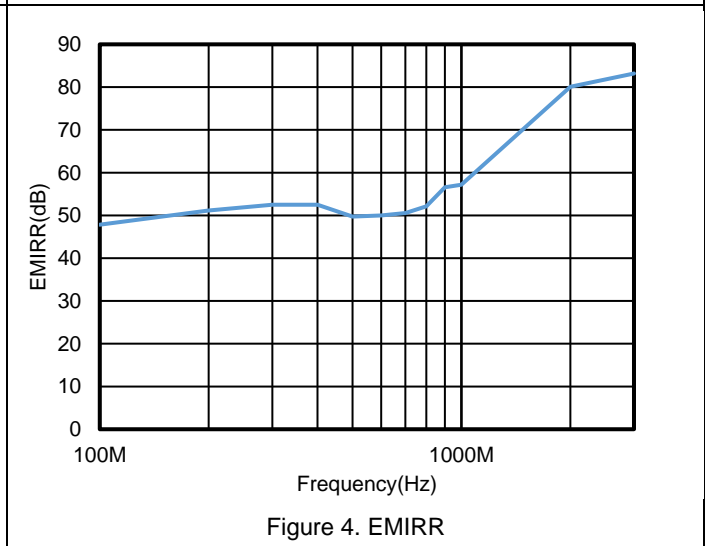
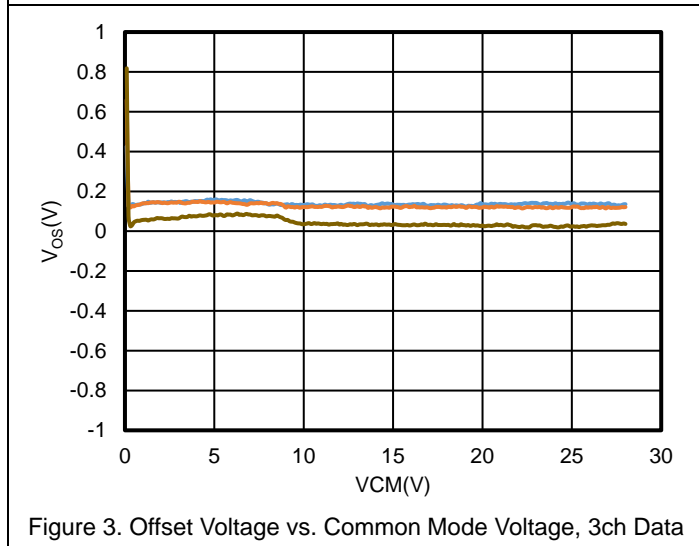
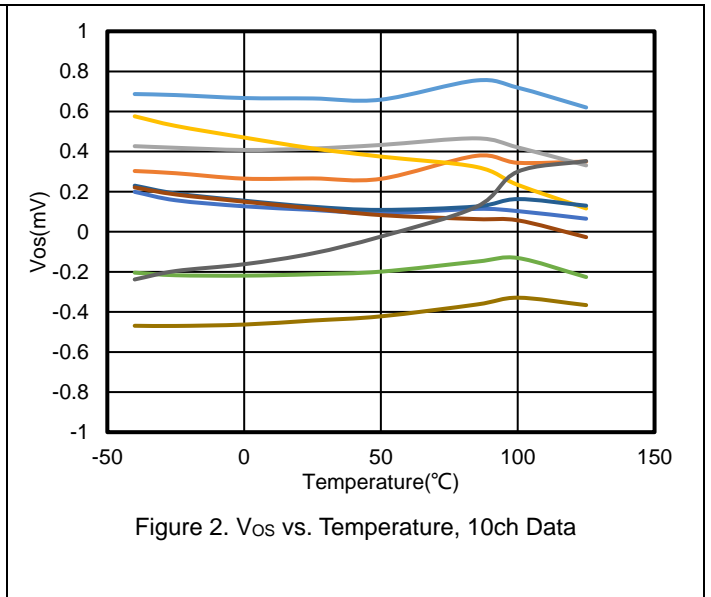
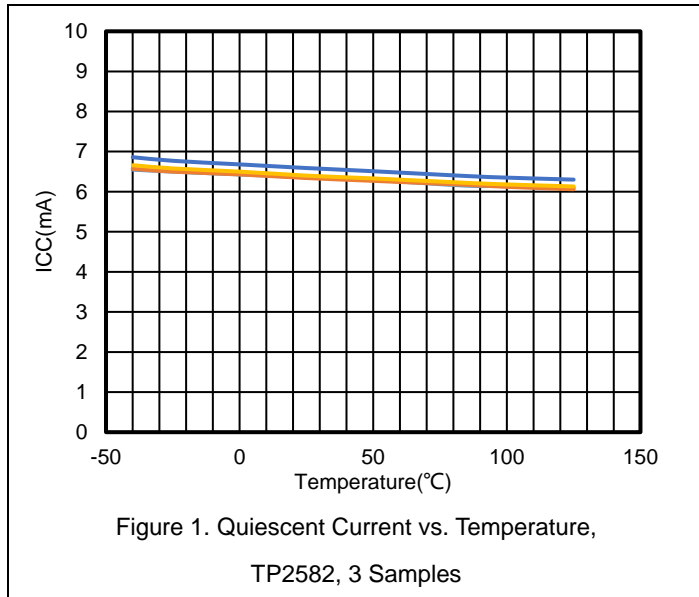

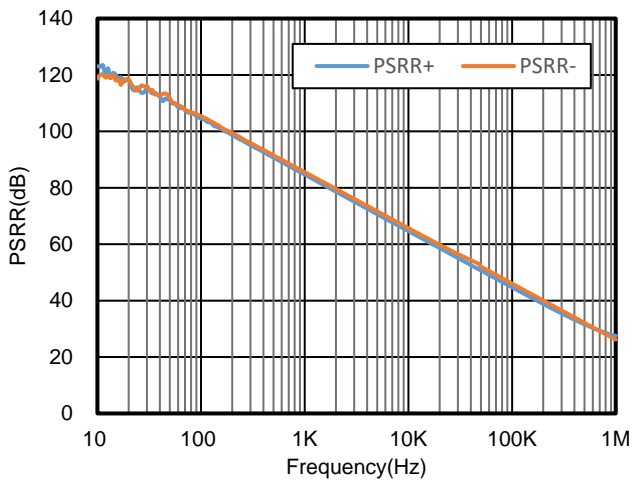

Figure 7. PSRR vs. Frequency

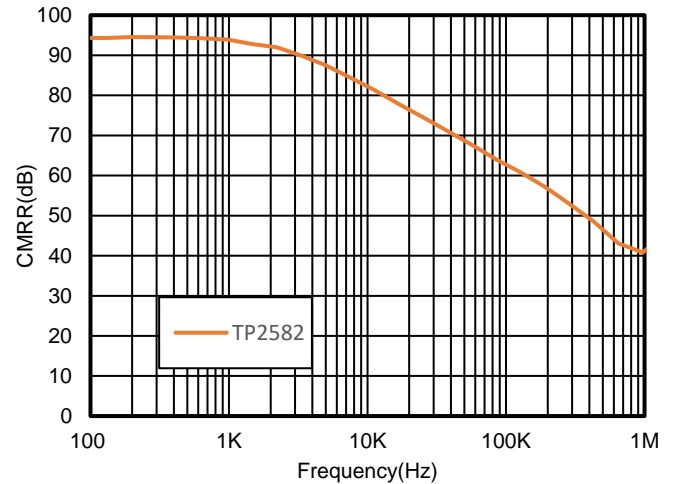

Figure 8. CMRR vs. Frequency

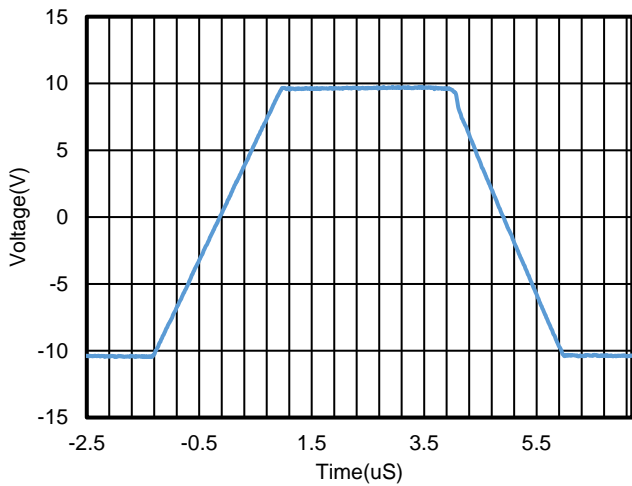

Figure 9. Large Signal Step Response,  
G = 1, R<sub>L</sub> = 10k $\Omega$ , C<sub>L</sub> = 100pF

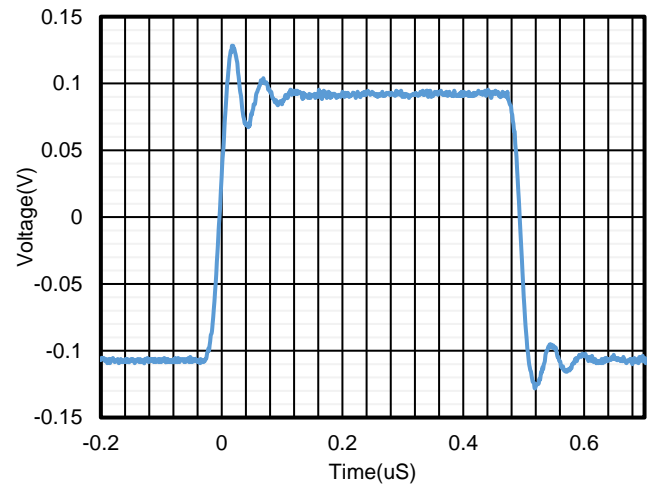

Figure 10. Small Signal Step Response,  
G = 1, R<sub>L</sub> = 10k $\Omega$ , C<sub>L</sub> = 100pF

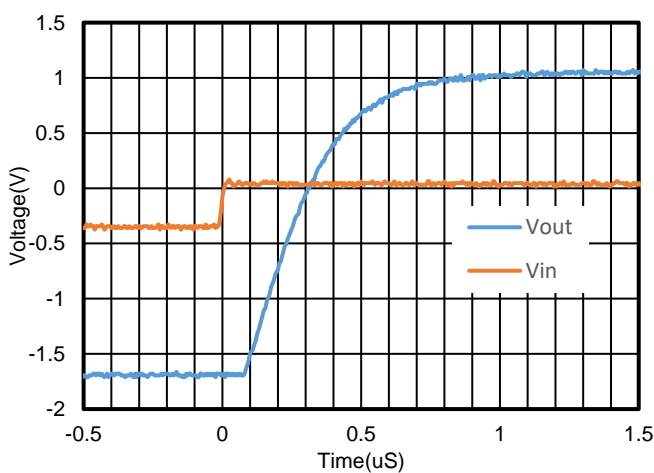

Figure 11. Positive Settling Time,  
V<sub>S</sub> = 3.3V, V<sub>CM</sub> = 1.65V, G = 11

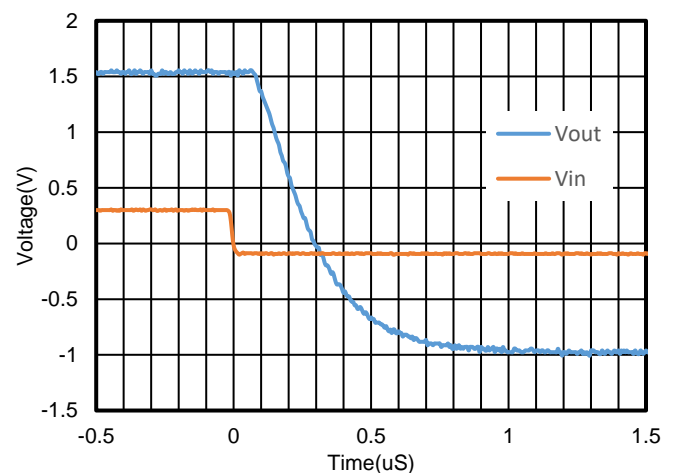

Figure 12. Negative Settling Time,  
V<sub>S</sub> = 3.3V, V<sub>CM</sub> = 1.65V, G = 11



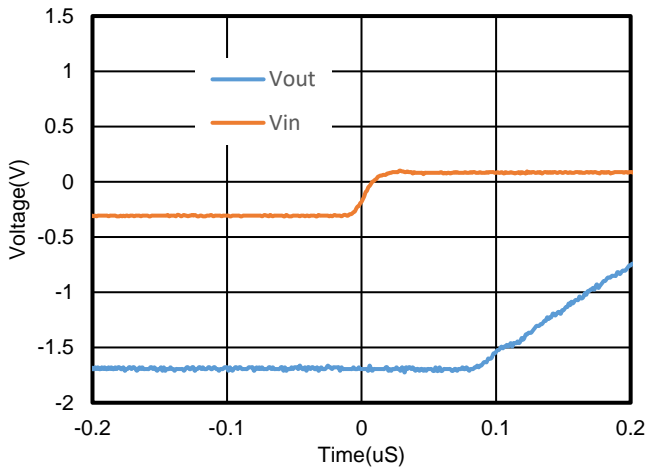

Figure 13. Positive Overload Recovery,  
 $V_S = 3.3V, V_{CM} = 1.65V, G = 11$

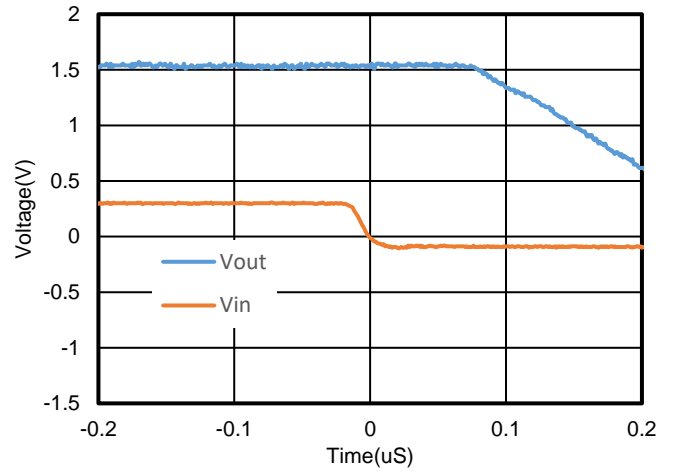
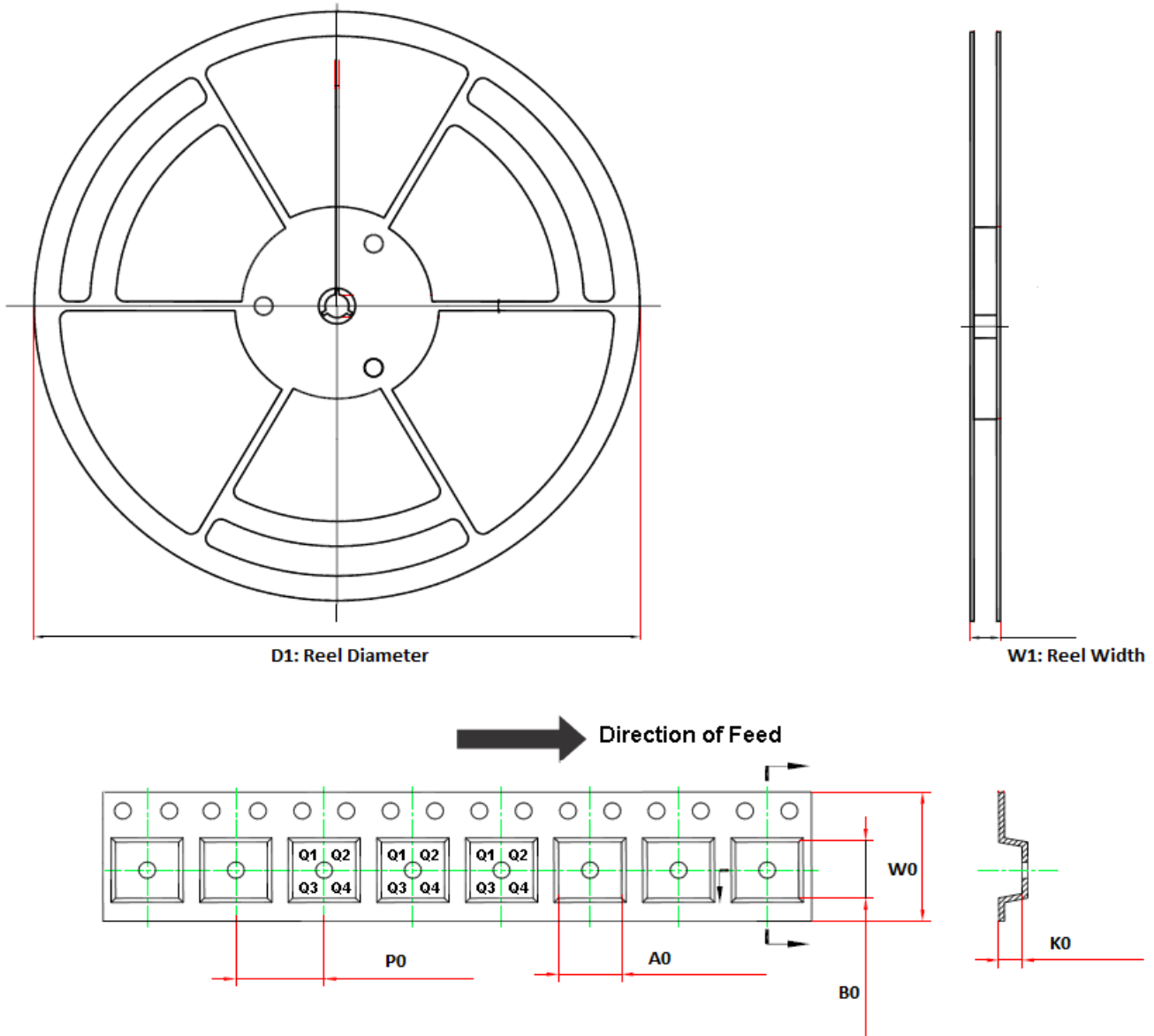

Figure 14. Negative Overload Recovery,  
 $V_S = 3.3V, V_{CM} = 1.65V, G = 11$

### Tape and Reel Information



Order Number	Package	D1	W1	A0	B0	K0	P0	W0	Pin1 Quadrant
TP2581-TR	5-Pin SOT23	180.0	13.1	3.2	3.2	1.4	4.0	8.0	Q3
TP2581-SR	8-Pin SOIC	330.0	17.6	6.4	5.4	2.1	8.0	12.0	Q1
TP2582-SR	8-Pin SOIC	330.0	17.6	6.4	5.4	2.1	8.0	12.0	Q1
TP2582-VR	8-Pin MSOP	330.0	17.6	5.2	3.3	1.5	8.0	12.0	Q1
TP2582-TSR	8-Pin TSSOP	330.0	17.6	6.8	3.3	1.2	8.0	12.0	Q1
TP2584-SR	14-Pin SOIC	330.0	21.6	6.5	9.0	2.1	8.0	16.0	Q1
TP2584-TR	14-Pin TSSOP	330.0	17.6	6.8	5.4	1.2	8.0	12.0	Q1

Package Outline Dimensions

SOT23-5

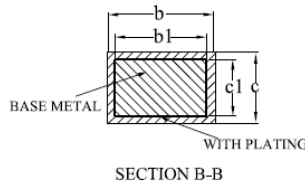
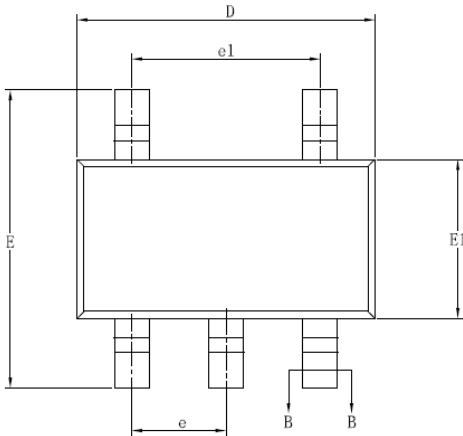
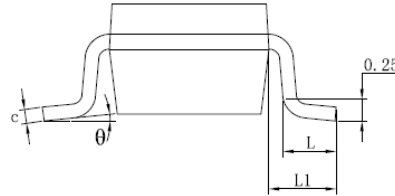
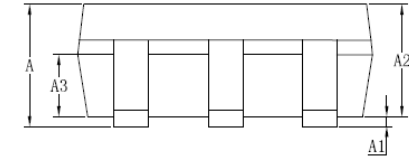

SYMBOL	MILLIMETER		
	MIN	NOM	MAX
A	—	—	1.25
A1	0.04	—	0.10
A2	1.00	1.10	1.20
A3	0.60	0.65	0.70
b	0.33	—	0.41
b1	0.32	0.35	0.38
c	0.15	—	0.19
c1	0.14	0.15	0.16
D	2.82	2.92	3.02
E	2.60	2.80	3.00
E1	1.50	1.60	1.70
e	0.95BSC		
e1	1.90BSC		
L	0.30	—	0.60
L1	0.60REF		
θ	0	—	8°

SOIC-8

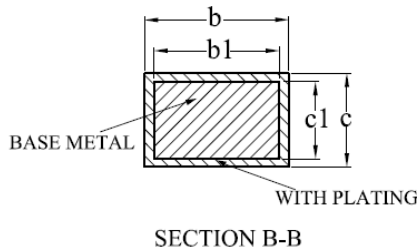
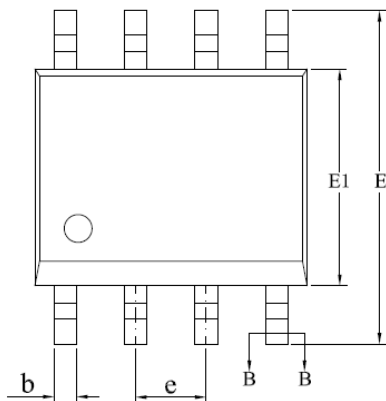
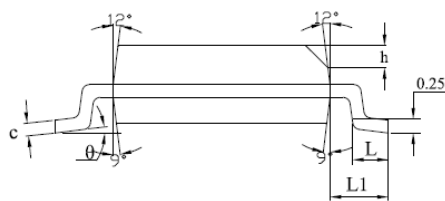
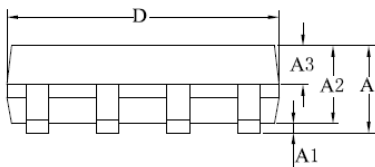

SYMBOL	MILLIMETER		
	MIN	NOM	MAX
A	—	—	1.75
A1	0.10	—	0.225
A2	1.30	1.40	1.50
A3	0.60	0.65	0.70
b	0.39	—	0.47
b1	0.38	0.41	0.44
c	0.20	—	0.24
c1	0.19	0.20	0.21
D	4.80	4.90	5.00
E	5.80	6.00	6.20
E1	3.80	3.90	4.00
e	1.27BSC		
h	0.25	—	0.50
L	0.50	—	0.80
L1	1.05REF		
θ	0	—	8°

TSSOP-8

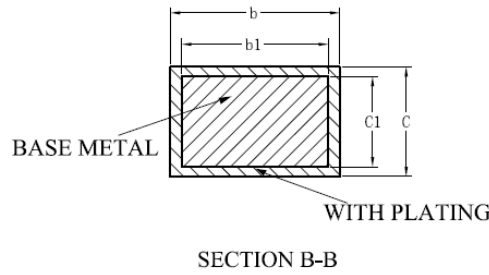
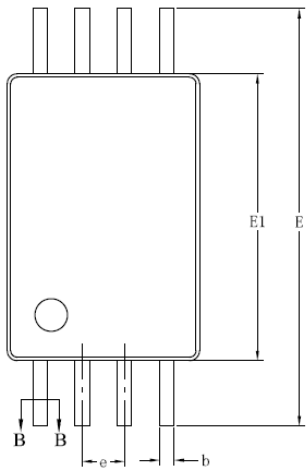
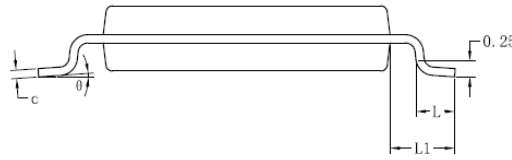
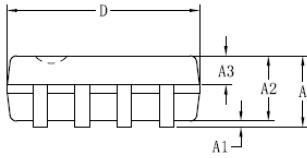

SYMBOL	MILLIMETER		
	MIN	NOM	MAX
A	—	—	1.20
A1	0.05	—	0.15
A2	0.90	1.00	1.05
A3	0.39	0.44	0.49
b	0.20	—	0.28
b1	0.19	0.22	0.25
c	0.13	—	0.17
c1	0.12	0.13	0.14
D	2.90	3.00	3.10
E1	4.30	4.40	4.50
E	6.20	6.40	6.60
e	0.65BSC		
L	0.45	—	0.75
L1	1.00REF		
θ	0	—	8°

MSOP-8

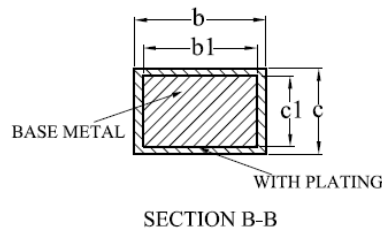
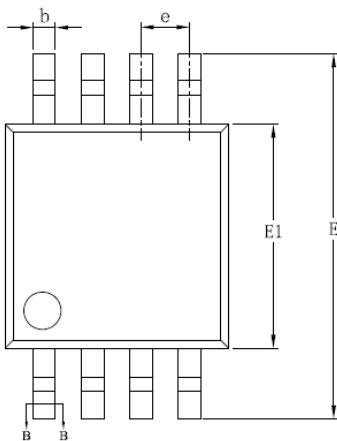
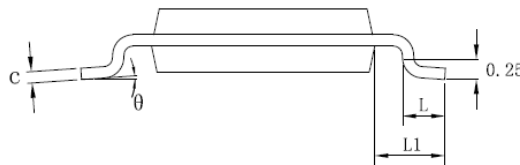
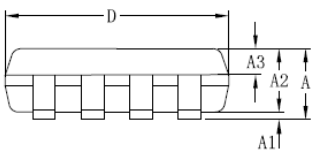

SYMBOL	MILLIMETER		
	MIN	NOM	MAX
A	—	—	1.10
A1	0.05	—	0.15
A2	0.75	0.85	0.95
A3	0.30	0.35	0.40
b	0.28	—	0.36
b1	0.27	0.30	0.33
c	0.15	—	0.19
c1	0.14	0.15	0.16
D	2.90	3.00	3.10
E	4.70	4.90	5.10
E1	2.90	3.00	3.10
e	0.65BSC		
L	0.40	—	0.70
L1	0.95REF		
θ	0	—	8°

SOIC-14

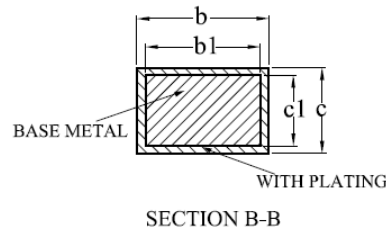
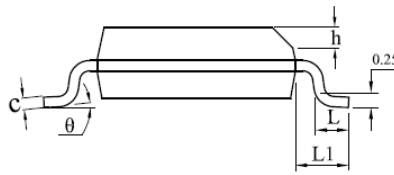
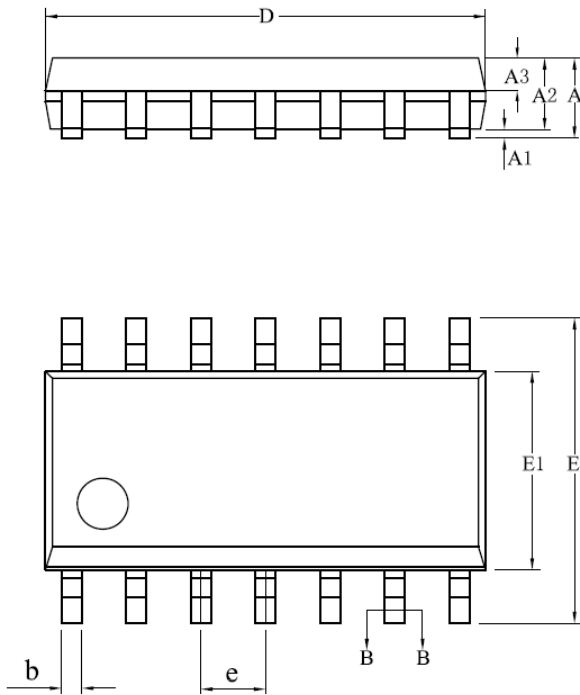

SYMBOL	MILLIMETER		
	MIN	NOM	MAX
A	—	—	1.75
A1	0.05	—	0.225
A2	1.30	1.40	1.50
A3	0.60	0.65	0.70
b	0.39	—	0.47
b1	0.38	0.41	0.44
c	0.20	—	0.24
c1	0.19	0.20	0.21
D	8.55	8.65	8.75
E	5.80	6.00	6.20
E1	3.80	3.90	4.00
e	1.27BSC		
h	0.25	—	0.50
L	0.50	—	0.80
L1	1.05REF		
θ	0	—	8°

TSSOP-14

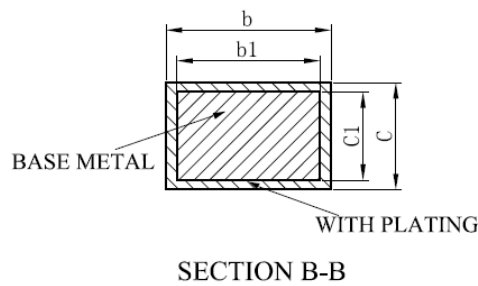
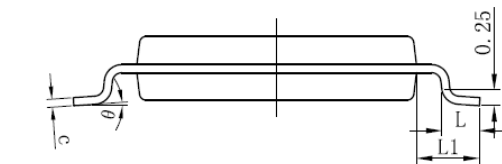
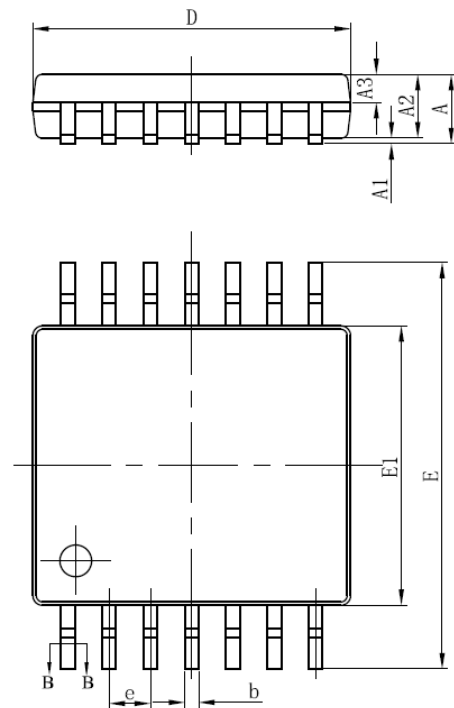

SYMBOL	MILLIMETER		
	MIN	NOM	MAX
A	—	—	1.20
A1	0.05	—	0.15
A2	0.90	1.00	1.05
A3	0.39	0.44	0.49
b	0.20	—	0.28
b1	0.19	0.22	0.25
c	0.13	—	0.17
c1	0.12	0.13	0.14
D	4.90	5.00	5.10
E1	4.30	4.40	4.50
E	6.20	6.40	6.60
e	0.65BSC		
L	0.45	0.60	0.75
L1	1.00BSC		
θ	0	—	8°

---

 ***3PEAK and the 3PEAK logo are registered trademarks of 3PEAK INCORPORATED. All other trademarks are the property of their respective owners.***

---

## X-ON Electronics

Largest Supplier of Electrical and Electronic Components

*Click to view similar products for [Operational Amplifiers - Op Amps](#) category:*

*Click to view products by [3PEAK](#) manufacturer:*

Other Similar products are found below :

[430227FB](#) [UPC451G2-A](#) [UPC824G2-A](#) [LT1678IS8](#) [042225DB](#) [058184EB](#) [UPC822G2-A](#) [UPC258G2-A](#) [NCS5651MNTXG](#)  
[NCV33202DMR2G](#) [NJM324E](#) [NTE925](#) [5962-9080901MCA\\*](#) [AZV358MTR-G1](#) [AP4310AUMTR-AG1](#) [HA1630D02MMEL-E](#)  
[HA1630S01LPEL-E](#) [AZV358MMTR-G1](#) [SCY33178DR2G](#) [NJU77806F3-TE1](#) [NCV5652MUTWG](#) [NCV20034DR2G](#) [NTE778S](#) [NTE871](#)  
[NTE924](#) [NTE937](#) [MCP6V16UT-E/OT](#) [MCP6V17T-E/MS](#) [MCP6V19T-E/ST](#) [SCY6358ADR2G](#) [NCS20282FCTTAG](#) [LM4565FVT-GE2](#)  
[EL5420CRZ-T7A](#) [TSV772IQ2T](#) [NJM2100M-TE1](#) [COS2262MR](#) [COS2252MR](#) [COS5532SRB](#) [COS2272MR](#) [LMV358MR](#) [COS6002MR](#)  
[LMV358SR](#) [LM358SR](#) [RC4580MM/TR](#) [HGV8544M/TR](#) [HGV8541M/TR](#) [HGV8634M/TR](#) [HGV8542M/TR](#) [HGV8544MT/TR](#)  
[LM2904M/TR](#)