

Powerpole® connectors provide cost-effective reliability, design flexibility and safety for your products' manufacture, installation and maintenance.

The housings are modular. They provide 600 Volts continuous, AC or DC operation. Wire sizes range from #14 to #16 AWG (2.1 to 1.3 mm<sup>2</sup>). Contacts are available in reeled and loose piece designs to support all production needs from engineering prototype, low volume and high volumes products.

### FEATURES

- **Make-first/Break-last connection**

*Provides safety and system integrity*

- **Green housing**

*Visual indication of ground terminal*

- **Molded-in dovetails**

*Can be assembled with standard Powerpole PP15, Powerpole PP30 and Powerpole PP45 connectors to make pre-grounded multipole configurations*

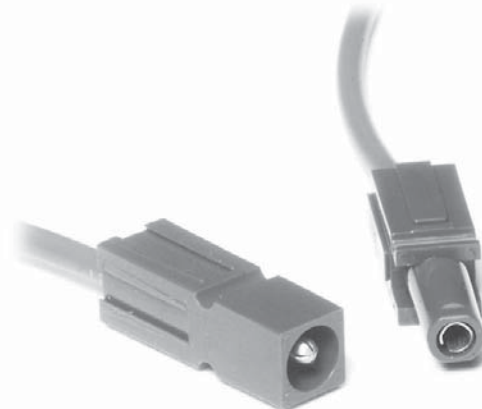

### PRODUCT SPECIFICATIONS

Connector Model	PP10 P & S	Connector Model	PP10 P & S
UL Current Rating (Amperes)*	10*	No load (Contact/Disconnect Cycles)	To 250
UL Voltage Ratings (Volts)**	600*	Avg. Connection/Disconnect (lbf)	5
Contact Barrel Wire Size (AWG)	#14 to #16	Operating Temperature Range °C***	-20° to 105°
(mm <sup>2</sup> )	2.1 to 1.3	°F	-4° to 221°
Maximum Wire Insulation Diameter (inches)	0.137	Flammability Rating of Housing Material	UL94 V-0
(mm)	3.48		
AVG Contact Resistance* (micro-ohms)	2200		
Insulation Withstanding Test Voltage (Volts AC/DC)	2200		
Contact Retention Force (lbf)	25		



\* UL Rated for 65°C largest wire or cable size

\*\* Both AC & DC Voltage

\*\*\* Contact factory for higher temperature rated connectors

### ORDERING INFORMATION

#### Housing & 10 amp Contact

Part Number	Housing Color	Wire	
		AWG	sq. mm
1200G1	Socket, Green	14/16	2.1/1.3
1201G1	Pin, Green	14/16	2.1/1.3

#### Housings Only

Part Number	Description
1204G1	Green housing, socket
1205G1	Green housing, pin

#### Tooling

Part Number	Description
1309G1	Hand tool, #14 to #16
260G3	Applicator only (110V & 220V)
280G2	Applicator and press (110V, 60Hz)
250G1	Press only (110V, 60Hz)
250G2	Press only (220V, 50Hz)

#### 10 amp Contacts

Part Number	Description	Wire	
		AWG	sq. mm
1202G1	Socket, Individual	14/16	2.1/1.3
264G1	Socket, Reel	14/16	2.1/1.3
1203G1	Pin, Individual	14/16	2.1/1.3
263G1	Pin, Reel	14/16	2.1/1.3

Note: For additional colors please contact customer service

HEADQUARTERS: Anderson Power Products®, 13 Pratts Junction Road, Sterling, MA 01564-2305 USA T:978-422-3600 F:978-422-3700

EUROPE: Anderson Power Products® Ltd., Unit 3, Europa Court, Europa Boulevard, Westbrook, Warrington, Cheshire, WA5 7TN United Kingdom T: +44 (0) 1925 428390 F: +44 (0) 1925 428399

ASIA / PACIFIC: IDEAL Anderson Asia Pacific Ltd., Unit 922-928 Topsail Plaza, 11 On Sum Street, Shatin N.T., Hong Kong T: +(852) 2636 0836 F: +(852) 2635 9036

CHINA: IDEAL Anderson Technologies (Shenzhen) Ltd., Block A8 Tantou Western Industrial Park, Songgang Baoan District, Shenzhen, P.R. China 518105 T: +(86) 755 2768 2118 F: +(86) 755 2768 2218

TAIWAN: IDEAL Anderson Asia Pacific Ltd., Taiwan Branch, 4F.-2, No.116, Dadun 20th St., Situn District, Taichung City 407, Taiwan (R.O.C.) T: +(886) 4 2310 6451 F: +(886) 4 2310 6460

[www.andersonpower.com](http://www.andersonpower.com)

## DIMENSIONS

### Housings

Series	-A-		-B-		-C-		-D-	
	mm	in.	mm	in.	mm	in.	mm	in.
PP10 Pin	7.9	0.31	7.9	0.31	24.5	0.97	41.3	1.63
PP10 Socket	7.9	0.31	7.9	0.31	27.5	1.081	41.3	1.63

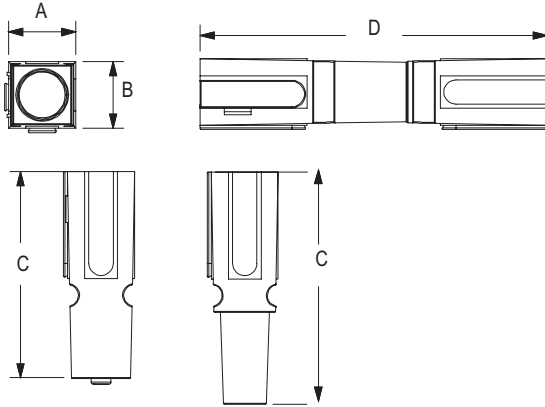

### Contacts

Series	-A-		-B-	
	mm	in.	mm	in.
PP10 Pin	22.4	0.88	2.4	0.093 - OD
PP10 Socket	22.4	0.88	2.3	0.089 - ID

#### Socket Contact

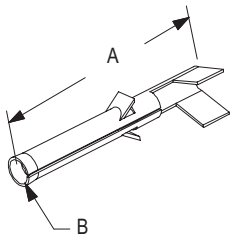

#### Pin Contact

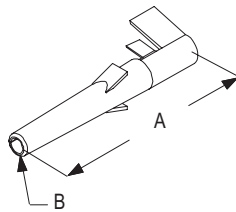

## TEMPERATURE RISE CHARTS

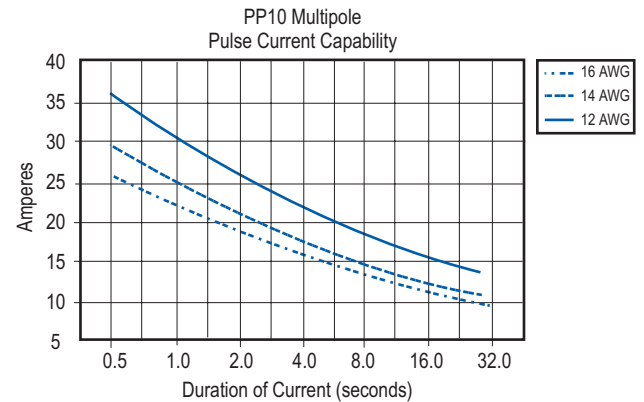
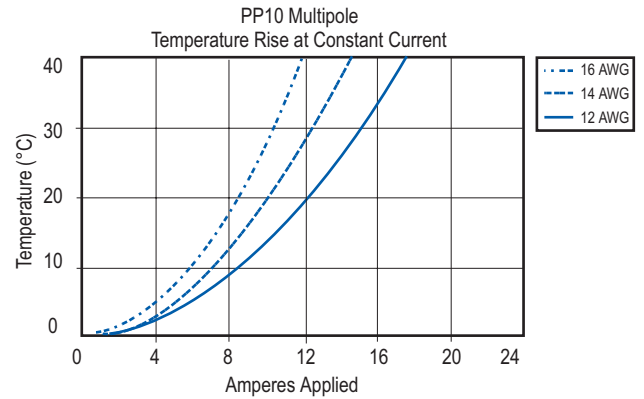
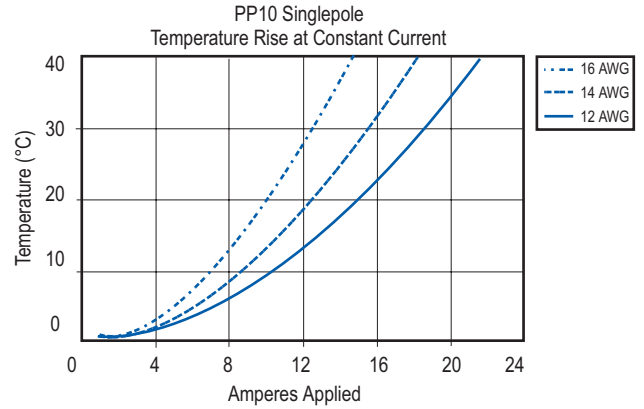

## X-ON Electronics

Largest Supplier of Electrical and Electronic Components

*Click to view similar products for* [Heavy Duty Power Connectors](#) *category:*

*Click to view products by* [Anderson Power Products](#) *manufacturer:*

Other Similar products are found below :

[1424439](#) [1424438](#) [09330062652](#) [2-8675P1](#) [605601-1](#) [6340G1](#) [6341G1](#) [6360G1](#) [6373G1](#) [6374g2](#) [6396G1](#) [647757-1](#) [66394-4](#) [6643411-1](#)  
[6646058-2](#) [6646137-1](#) [6646138-1](#) [6646348-1](#) [6646479-1](#) [6646608-1](#) [6646786-1](#) [6646940-1](#) [6651091-1](#) [6651525-1](#) [6651529-1](#) [6651778-1](#)  
[6651788-1](#) [696465-1](#) [696475-1](#) [73000005059](#) [73000005349](#) [73000005642](#) [73080255059](#) [73080965046](#) [765-15-0080A](#) [765-16-0080B](#)  
[789.700-44](#) [789.700-54](#) [80-1010](#) [80-9](#) [827381-1](#) [829992-1](#) [902-77-02113](#) [PL00U-301-10D10](#) [PM103MOOLOO](#) [PM16S1620S32-50](#)  
[PM212MOOLOO](#) [PM309FOOLOO](#) [PM324FOOLCH](#) [PMHPAF11S03](#)