

# High Reliability, Military D Subminiature, & Non-Magnetic/No-Outgas

Solder Cup



(See page 333)

Crimp



(See page 334-335)

Printed Circuit



(See page 336-338)

## Performance and Material Specifications

### MATERIALS AND FINISHES

	Standard		Military	
	Material	Finish	Material	Finish
Shell	Steel per ASTM A-620	Yellow chromate over cadmium QQ-P-416 Type II Class 2	Steel per ASTM A-620	Yellow chromate over cadmium QQ-P-416 Type II Class 2
Insulator	Diallyl phthalate glass-filled per MIL-M-14, type SDG-F, color green		Diallyl phthalate glass-filled per MIL-M-14, type SDG-F, color green	
Contact	Copper alloy	Gold over nickel	Copper Alloy Crimp Socket has stainless steel hood passivated.	Gold 50 microinches minimum thickness per MIL-G-45204 Type II Grade C Class 1 over copper per MIL-C-14550 Hood: Passivated
Float Mount Hardware	Stainless steel	Passivate per QQ-P-35	Stainless steel	Passivate per QQ-P-35

### PERFORMANCE SPECIFICATIONS

Wire Accommodation (AWG)	Solder - #20 Max. Crimp - #18- #30 Max.
Current Rating	#20; 5 Amp
Temperature Rating	-65°C to +150°C
Contact Resistance	55 @ 7.5 Amp
After Salt Spray, Millivolt Max.	test current

See pages 339 and 340 for complete M24308 cross reference.

### DIELECTRIC WITHSTANDING VOLTAGE

	90° and Straight (Solder/Crimp)			
	Altitude (feet/m)			
	Sea Level	20,000/6,096	50,000/15,240	70,000/21,336
Average Flashover	1700/1500	1000/1000	650/500	500/500
Test	1250/1000	750/650	475/325	375/325

All voltage figures are rms AC 60 rms cps, measured at approximately +25°C, 50% rh. For additional performance specifications refer to MIL-C-24308 Test Extracts on page 385.

## Non-Magnetic/No-Outgas Options

Suffix Code	Residual Magnetism	Shell Material (Finish)	Desired Results
NMB	200 Gamma Residual Magnetism Insulator. (Diallyl Phtalate per MIL-M-14 type SDG-F, color white.)	Bras Shells Per QQ-B-613 (Yellow Chromate over Cadmium per QQ-P-416, Type II, Class 2.)	Non-Magnetic No-Outgas
NMB-K52	200 Gamma Residual Magnetism Insulator. (Diallyl Phtalate per MIL-M-14 type SDG-F, color white.)	Brass Shells Per QQ-B-613 (Gold over copper per MIL-G-45204, Type II, Grade C, Class 1 over copper per MIL-C-14550.)	Non-Magnetic No-Outgas

Note: Look for the **NM** symbol for orderign information.

## Contact Arrangements

### Face View Pin Insert

Shell Size  
Contact Arrangement  
Contact Size

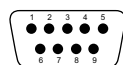

E

9

#20

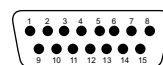

A

15

#20

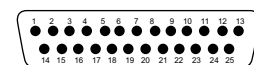

B

25

#20

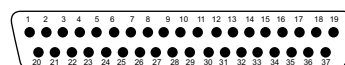

C

37

#20

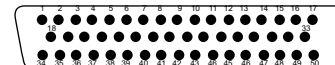

D

50

#20

Shell Size  
Contact Arrangement  
Contact Size

## How to Order High Rel-Solder Cup Connectors (contacts are non-removable)



### Mounting Options Available:

- 4-40 Clinch Nut - Add "E" to Part Number After "M"
- 4-40 Float Mount - Add "Y" to Part Number After "M"
- (Can be used in front or rear panel mount applications)

Example: DBME25S DEMY9P  
DBMME25S DEMMY9P

Performance Specifications - Page 332.

### Receptacles (Includes Socket Contacts) With .120" Through-Mounting Holes

Number of Contacts (Shell Size)	Standard	Military Version	M24308 Cross Reference
9 (E)	DEM9S	DEMM9S	M24308/1-1
15 (A)	DAM15S	DAMM15S	M24308/1-2
25 (B)	DBM25S	DBMM25S	M24308/1-3
37 (C)	DCM37S	DCMM37S	M24308/1-4
50 (D)	DDM50S	DDMM50S	M24308/1-5

### Plugs (Includes Pin Contacts)\* With .120" Through-Mounting Holes

Number of Contacts (Shell Size)	Standard	Military Version	M24308 Cross Reference
9 (E)	DEM9P	DEMM9P	M24308/3-1
15 (A)	DAM15P	DAMM15P	M24308/3-2
25 (B)	DBM25P	DBMM25P	M24308/3-3
37 (C)	DCM37P	DCMM37P	M24308/3-4
50 (D)	DDM50P	DDMM50P	M24308/3-5

**NM** Non-Magnetic/No Outgas-Add desired suffix code with desired option to end of part number.

Example: DEMA9PSNMB  
DEMA9PSNMB-K52

## Dimensions - High Rel Solder Cup Connectors

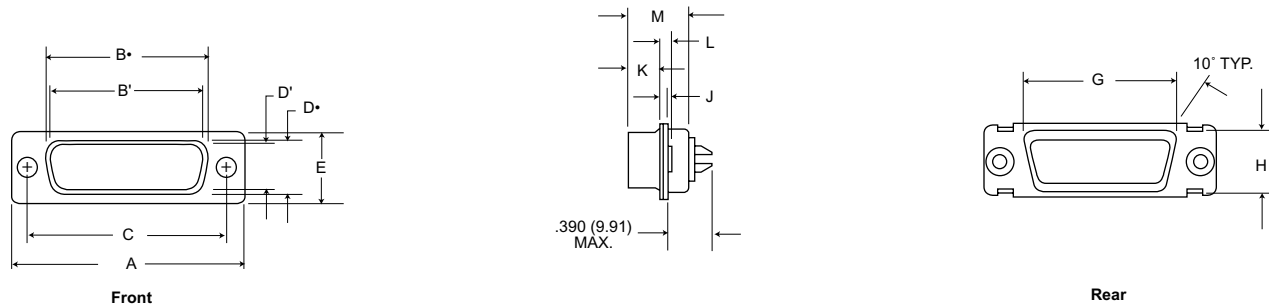

Part Number by Shell Size	A	B+	B'	C	D+	D'	E	G	H	J	K	L	M
DEM-9P	1.213 (30.81)	-	.666 (16.91)	.984 (24.99)	-	.329 (8.36)	.494 (12.55)	.759 (19.28)	.422 (10.72)	.030 (0.76)	.235 (5.94)	.048 (1.22)	.422 (10.72)
DEM-9S	1.213 (30.81)	.643 (16.33)	-	.984 (24.99)	.311 (7.90)	-	.494 (12.55)	.759 (19.28)	.422 (10.72)	.030 (0.76)	.243 (6.17)	.048 (1.22)	.429 (10.90)
DAM-15P	1.541 (39.14)	-	.994 (25.24)	1.312 (33.32)	-	.329 (8.36)	.494 (12.55)	1.083 (27.51)	.422 (10.72)	.030 (0.76)	.235 (5.97)	.048 (1.22)	.422 (10.72)
DAM-15S	1.541 (39.14)	.971 (24.66)	-	1.312 (33.32)	.311 (7.90)	-	.494 (12.55)	1.083 (27.51)	.422 (10.72)	.030 (0.76)	.243 (6.17)	.048 (1.22)	.429 (10.90)
DBM-25P	2.088 (53.03)	-	1.534 (38.96)	1.852 (47.04)	-	.329 (8.36)	.494 (12.55)	1.625 (41.27)	.422 (10.72)	.039 (0.99)	.230 (5.84)	.060 (1.52)	.426 (10.82)
DBM-25S	2.088 (53.03)	1.511 (38.38)	-	1.852 (47.04)	.311 (7.90)	-	.494 (12.55)	1.625 (41.27)	.422 (10.72)	.030 (0.76)	.243 (6.17)	.048 (1.22)	.429 (10.90)
DCM-37P	2.729 (69.31)	-	2.182 (55.42)	2.500 (63.50)	-	.329 (8.36)	.494 (12.55)	2.272 (57.71)	.422 (10.72)	.039 (0.99)	.230 (5.84)	.060 (1.52)	.426 (10.82)
DCM-37S	2.729 (69.31)	2.159 (54.84)	-	2.500 (63.50)	.311 (7.90)	-	.494 (12.55)	2.272 (57.71)	.422 (10.72)	.030 (0.76)	.243 (6.17)	.048 (1.22)	.429 (10.90)
DDM-50P	2.635 (66.92)	-	2.079 (52.81)	2.406 (61.11)	-	.441 (11.20)	.605 (15.37)	2.178 (55.32)	.534 (13.56)	.039 (0.99)	.230 (5.84)	.060 (1.52)	.426 (10.82)
DDM-50S	2.635 (66.92)	2.064 (52.43)	-	2.406 (61.11)	.423 (10.74)	-	.605 (15.37)	2.178 (55.32)	.534 (13.56)	.030 (0.76)	.243 (6.17)	.048 (1.22)	.429 (10.90)

\*Dimensions B, D, G, and H are measured as outside dimensions at the bottom of the draw.  
NOTE: B+ and D+ are the D.D. dims for socket side B' and D' are the I. D. dims. for pin side

## Mounting Option Dimensions - Crimp Components

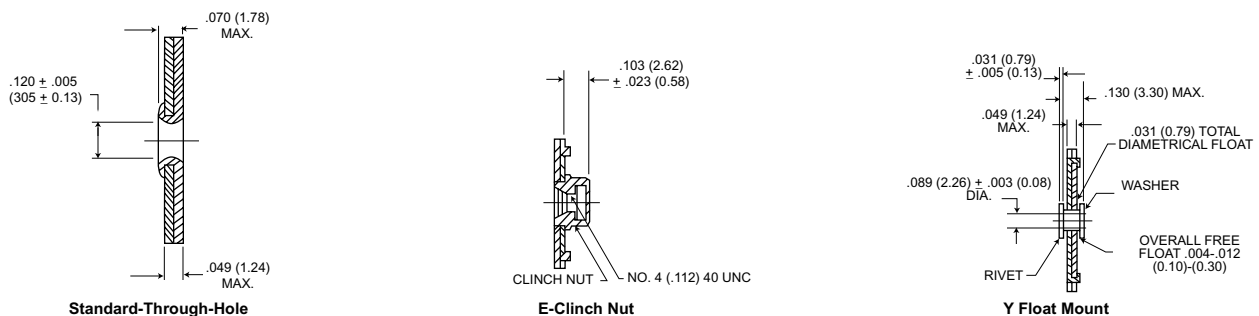

It is recommended that only one assembly, either pin or socket, be float mounted.

Dimensions are shown in inches (millimeters).  
Dimensions subject to change.

## How to Order - Crimp Connectors (contacts are removable)



### Receptacles (Includes Socket Contacts) With .120" Through-Mounting Holes

Number of Contacts (Shell Size)	Standard	Military Version	M24308 Cross Reference
9 (E)	DEMA9S	DEMAM9S	M24308/2-1
15 (A)	DAMA15S	DAMAM15S	M24308/2-2
25 (B)	DBMA25S	DBMAM25S	M24308/2-3
37 (C)	DCMA37S	DCMAM37S	M24308/2-4
50 (D)	DDMA50S	DDMAM50S	M24308/2-5

### Plugs (Includes Pin Contacts)\* With .120" Through-Mounting Holes

Number of Contacts (Shell Size)	Standard	Military Version	M24308 Cross Reference
9 (E)	DEMA9P	DEMAM9P	M24308/4-1
15 (A)	DAMA15P	DAMAM15P	M24308/4-2
25 (B)	DBMA25P	DBMAM25P	M24308/4-3
37 (C)	DCMA37P	DCMAM37P	M24308/4-4
50 (D)	DDMA50P	DDMAM50P	M24308/4-5

To receive these connectors without contacts, add "F0" to end of part number.

Example: DBMA25SF0, DBMAM25SF0.

**NM** Non-Magnetic/No Outgas-Add desired suffix code with desired option to end of part number.

Example: DEMA9PSNMB  
DEMA9PSNMB-K52

Crimp Connectors without contacts, add F0 to end of the part number and change K52 to K47.

Assembly Instructions - Page 363.

Performance Specifications - Page 332.

### Mounting Options Available:

- 4-40 Clinch Nut - Add "E" to Part Number After "M" or "A"
  - 4-40 Flood Mount - Add "Y" to Part Number After "M" or "A"
- (Can be used in front or rear panel mount applications)

Example: DBMAE25S  
DBMAM25S  
DEMAY9P  
DBMAMY9P

## Dimensions - Crimp Connectors

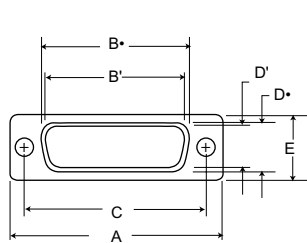

Front

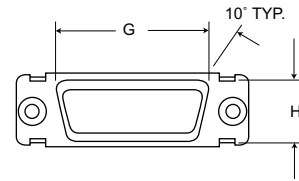
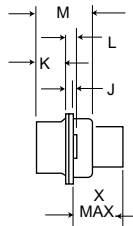

Rear

Part Number by Shell Size	A	B	B'	C	D	D'	E	G	H	J	K	L	M	X Max.
DEMA-9P	1.213 (30.81)	-	.666 (16.91)	.984 (24.99)	-	.329 (8.36)	.494 (12.55)	.759 (19.28)	.422 (10.72)	.030 (0.76)	.235 (5.97)	.048 (1.22)	.422 (10.72)	.345 (8.76)
DEMA-9S	1.213 (30.81)	.643 (16.33)	-	.984 (24.99)	.311 (7.90)	-	.494 (12.55)	.759 (19.28)	.422 (10.72)	.030 (0.76)	.243 (6.17)	.048 (1.22)	.429 (10.90)	.345 (8.76)
DAMA-15P	1.541 (39.14)	-	.994 (25.24)	1.312 (33.32)	-	.329 (8.36)	.494 (12.55)	1.083 (27.51)	.422 (10.72)	.030 (0.76)	.235 (5.97)	.048 (1.22)	.422 (10.72)	.345 (8.76)
DAMA-15S	1.541 (39.14)	.971 (24.66)	-	1.312 (33.32)	.311 (7.90)	-	.494 (12.55)	1.083 (27.51)	.422 (10.72)	.030 (0.76)	.243 (6.17)	.048 (1.22)	.429 (10.90)	.345 (8.76)
DBMA-25P	2.088 (53.03)	-	1.534 (38.96)	1.852 (47.04)	-	.329 (8.36)	.494 (12.55)	1.625 (41.27)	.422 (10.72)	.039 (0.99)	.230 (5.84)	.060 (1.52)	.426 (10.82)	.345 (8.76)
DBMA-25S	2.088 (53.03)	1.511 (38.38)	-	1.852 (47.04)	.311 (7.90)	-	.494 (12.55)	1.625 (41.27)	.422 (10.72)	.030 (0.76)	.243 (6.17)	.048 (1.22)	.429 (10.90)	.345 (8.76)
DCMA-37P	2.729 (69.31)	-	2.182 (55.42)	2.500 (63.50)	-	.329 (8.36)	.494 (12.55)	2.272 (57.71)	.422 (10.72)	.039 (0.99)	.230 (5.84)	.060 (1.52)	.426 (10.82)	.345 (8.76)
DCMA-37S	2.729 (69.31)	2.159 (54.84)	-	2.500 (63.50)	.311 (7.90)	-	.494 (12.55)	2.272 (57.71)	.422 (10.72)	.030 (0.76)	.243 (6.17)	.048 (1.22)	.429 (10.90)	.345 (8.76)
DDMA-50P	2.635 (66.92)	-	2.079 (52.81)	2.406 (61.11)	-	.441 (11.20)	.605 (15.37)	2.178 (55.32)	.534 (13.56)	.039 (0.99)	.230 (5.84)	.060 (1.52)	.426 (10.82)	.345 (8.76)
DDMA-50S	2.635 (66.92)	2.064 (52.43)	-	2.406 (61.11)	.423 (10.74)	-	.605 (15.37)	2.178 (55.32)	.534 (13.56)	.030 (0.76)	.243 (6.17)	.048 (1.22)	.429 (10.90)	.345 (8.76)

## Mounting Option Dimensions - Crimp Components

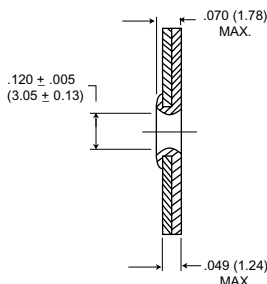

Standard-Through-Hole

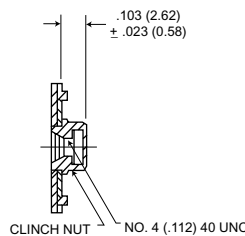

E-Clinch Nut

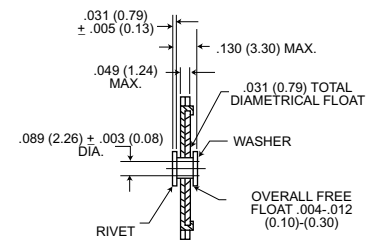

Y Float Mount

It is recommended that only one assembly, either pin or socket, be float mounted.

Dimensions are shown in inches (millimeters).  
Dimensions subject to change.

## High Rel Crimp Contacts

### MATERIALS AND FINISHES

Contact Size	Wire Size Accom.	Standard Finish		Military Finish		NM	
		Pin	Socket	Pin	Socket	NMB	
						Pin	Socket
20	20, 22, 24	330-5291-000	031-1007-000	330-5291-037	031-1007-042	330-5291-037	031-1007-057
20-18	1 #18 & 2 #22	330-5291-001	031-1007-001	330-5291-055	031-1007-054	-	-
20-26	26, 28, 30	330-5291-004	031-1007-004	330-5291-050	031-1007-048	-	-
22D	22, 24, 26, 28			030-2042-002*	031-1147-002*	-	-

### MIL-C-39029 Cross-Reference

Contact Size	Wire Size Accom.	M39029	M24308	Cannon Part No.
20 Pin	20/22/24	/64-369	/11-1	330-5291-037
20 Socket	20/22/24	/36-368	/10-1	031-1007-042
22D Pin	24/26/28	/58-360	/13-1	030-2042-000
22D Socket	22/24/26/28	/57-354	/12-1	031-1147-000

Assembly Instructions - Page 363

\*50 microinch AU over copper, no stripes.

## Tooling

### Insertion/Extraction Tools

#### CIET-20HD

Contact Size	AWG	Plastic Insertion/Extraction		Plastic Extraction	
		Part No.	Description	Part No.	Description
20	20, 22, 24	980-2000-426	CIET-20HD	323-7010-000	CET-20-11
2026	26, 28, 30	980-2000-426	CIET 20HD	323-7010-000	CET-20-11
2018	1 #18	None	None	274-5016-002	CET-20-15
	2 #22	None	None	274-5016-002	CET-20-15
22D	22, 24, 26, 28	274-7048-000	CIET 22D	None	None
High Power	12, 16	274-7003-000	CIET 12	None	None
High Volt	#20	274-7003-000	CIET 12	None	None

### Hand Crimp Tools



#### M22520/1-01

#### M22520/2-01

Contact Size	AWG	Crimp Tool		Locator	
		Part No.	Description	Part No.	Description
		995-0001-584	M22520/2-01	995-0001-604	M22520/2-08
20	20, 22, 24	995-0001-585	M22520/2-01	995-0001-244	TH25
2026	26, 28, 30	995-0001-584	M22520/2-01	995-0001-325	L3198-20HD
2018	1 #18	995-0001-584	M22520/2-01	980-0005-722	K250
	2 #22				
22D	22, 24, 26, 28	995-0001-584	M22520/2-01	995-0001-739	M22520/2-06

### Semi-Automatic Crimp Machines

The CBT-646, Vibra-Bowl Crimper is pneumatically powered, electronically controlled machine. It is designed to semi-automatically crimp closed barrel, machined contacts, as used in the aerospace and commercial industries. The machine will accommodate wire sizes 30 thru 12 AWG. The CBT-646 is actuated automatically upon insertion of a pre-stripped stranded or single conductor wire. The CBT-646 meets all Mil. Spec. requirements for crimping closed barrel contacts.

**Machine Crimp Rate:** 1300 + per hour

**Power Requirements:** Electrical = 115 Vac., 60 Hz, 5A  
Pneumatic = 85 psi., 2 cu. ft. per min.

Products: Most ITT Cannon Commercial and Aerospace closed barrel contacts, wire sizes 30 thru 12 AWG.  
(See connector line for part numbers.)

CBT-646

## How to Order - High-Rel Printed Circuit Mount Connectors

**Straight PC Tail, Receptacles (Includes Socket Contacts) With .120 (3.15) Through-Mounting Holes.**



Number of Contacts (Shell Size)	PC Tails - .030 (0.76) Diameter			Wire Wrap Post - .024 (0.61) Square	
	.127 (3.23) ± .027 (0.69) Long Post	.158 (4.01) ± .027 (0.69) Long Post	.183 (4.65) ± .027 (0.69) Long Post	.405 (10.29) ± .027 (0.69) Long Post (Two Wrap)	.530 (13.46) ± .027 (0.69) Long Post (Three Wrap)
9 (E) Standard	DEM9SE	DEM9SM	DEM9SZ	DEM9SF179	DEM9SF179A
9 (E) Military	DEMM9SE	DEMM9SM	DEMM9SZ	DEMM9SF179	DEMM9SF179A
15 (A) Standard	DAM15SE	DAM15SM	DAM15SZ	DAM15SF179	DAM15SF179A
15 (A) Military	DAMM15SE	DAMM15SM	DAMM15SZ	DAMM15SF179	DAMM15SF179A
25 (B) Standard	DBM25SE	DBM25SM	DBM25SZ	DBM25SF179	DBM25SF179A
25 (B) Military	DBMM25SE	DBMM25SM	DBMM25SZ	DBMM25SF179	DBMM25SF179A
37 (C) Standard	DCM37SE	DCM37SM	DCM37SZ	DCM37SF179	DCM37SF179A
37 (C) Military	DCMM37SE	DCMM37SM	DCMM37SZ	DCMM37SF179	DCMM37SF179A
50 (D) Standard	DDM50SE	DDM50SM	DDM50SZ	DDM50SF179	DDM50SF179A
50 (D) Military	DDMM50SE	DDMM50SM	DDMM50SZ	DDMM50SF179	DDMM50SF179A

**NM Non-Magnetic/No-Outgas** - Add desired suffix code (NMB, NM-K52) to end of part number. Example: DEM95ZNM-B-K52

**Straight PC Tail, Plug (Includes Pin Contacts) With .120 (3.15) Through-Mounting Holes**



Number of Contacts (Shell Size)	PC Tails - .030 (0.76) Diameter			Wire Wrap Post - .024 (0.61) Square	
	.127 (3.23) ± .027 (0.69) Long Post	.158 (4.01) ± .027 (0.69) Long Post	.183 (4.65) ± .027 (0.69) Long Post	.405 (10.29) ± .027 (0.69) Long Post (Two Wrap)	.530 (13.46) ± .027 (0.69) Long Post (Three Wrap)
9 (E) Standard	DEM9PE	DEM9PM	DEM9PZ	DEM9PF179	DEM9PF179A
9 (E) Military	DEMM9PE	DEMM9PM	DEMM9PZ	DEMM9PF179	DEMM9PF179A
15 (A) Standard	DAM15PE	DAM15PM	DAM15PZ	DAM15PF179	DAM15PF179A
15 (A) Military	DAMM15PE	DAMM15PM	DAMM15PZ	DAMM15PF179	DAMM15PF179A
25 (B) Standard	DBM25PE	DBM25PM	DBM25PZ	DBM25PF179	DBM25PF179A
25 (B) Military	DBMM25PE	DBMM25PM	DBMM25PZ	DBMM25PF179	DBMM25PF179A
37 (C) Standard	DCM37PE	DCM37PM	DCM37PZ	DCM37PF179	DCM37PF179A
37 (C) Military	DCMM37PE	DCMM37PM	DCMM37PZ	DCMM37PF179	DCMM37PF179A
50 (D) Standard	DDM50PE	DDM50PM	DDM50PZ	DDM50PF179	DDM50PF179A
50 (D) Military	DDMM50PE	DDMM50PM	DDMM50PZ	DDMM50PF179	DDMM50PF179A

**NM Non-Magnetic/No-Outgas** - Add desired suffix code (NMB, NM-K52) to end of part number. Example: DEM9PZNM-B-K52

## Dimensions

### Printed Circuit Applications

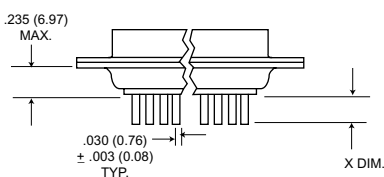

\*All MIL-C-24308 connectors come with .250 (0.10) length spacers.

### Wire Wrapping Applications

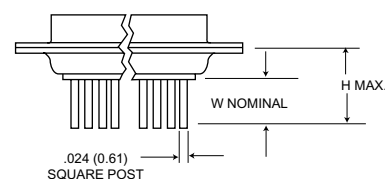

Code (Last Letter of Part Number)	Straight X ± .027 (0.69)	Modification Code	Number of Wraps	W	H
E	.127 (3.22)	F179	2	.405 (10.29)	.655 (16.64)
M	.158 (4.01)	F179A	3	.530 (13.46)	.780 (19.81)
Z	.183 (4.65)				

## How to Order - High-Rel Printed Circuit Mount Connectors

### Right Angle PC Tail Receptacles, With Bracket (.120 (3.15) Though-Holes Only)



Number of Contacts (Shell Size)	PC Tails - .030 (0.76) Diameter		
	.127 (3.23) ± .027 (0.69) Long Post	.158 (4.01) ± .027 (0.69) Long Post	.183 (4.65) ± .027 (0.69) Long Post
9 (E) Standard	DEM9SD	DEM9SL	DEM9SS
9 (E) Military	DEM9SD	DEM9SL	DEM9SS
15 (A) Standard	DAM15SD	DAM15SL	DAM15SS
15 (A) Military	DAMM15SD	DAMM15SL	DAMM15SS
25 (B) Standard	DBM25SD	DBM25SL	DBM25SS
25 (B) Military	DBMM25SD	DBMM25SL	DBMM25SS
37 (C) Standard	DCM37SD	DCM37SL	DCM37SS
37 (C) Military	DCMM37SD	DCMM37SL	DCMM37SS
50 (D) Standard	DDM50SD	DDM50SL	DDM50SS
50 (D) Military	DDMM50SD	DDMM50SL	DDMM50SS

**NM Non-Magnetic/No-Outgas** - Add desired suffix cod (NMB, NM-K52) to end of part number. Example: DEM9SLNMB-K52

### Right Angle PC Tail Plug, With Bracket (.120 (3.15) Through-Holes Only)



Number of Contacts (Shell Size)	PC Tails - .030 (0.76) Diameter		
	.127 (3.23) ± .027 (0.69) Long Post	.158 (4.01) ± .027 (0.69) Long Post	.183 (4.65) ± .027 (0.69) Long Post
9 (E) Standard	DEM9PD	DEM9PL	DEM9PS
9 (E) Military	DEM9PD	DEM9PL	DEM9PS
15 (A) Standard	DAM15PD	DAM15PL	DAM15PS
15 (A) Military	DAMM15PD	DAMM15PL	DAMM15PS
25 (B) Standard	DBM25PD	DBM25PL	DBM25PS
25 (B) Military	DBMM25PD	DBMM25PL	DBMM25PS
37 (C) Standard	DCM37PD	DCM37PL	DCM37PS
37 (C) Military	DCMM37PD	DCMM37PL	DCMM37PS
50 (D) Standard	DDM50PD	DDM50PL	DDM50PS
50 (D) Military	DDMM50PD	DDMM50PL	DDMM50PS

**NM Non-Magnetic/No-Outgas** - Add desired suffix cod (NMB, NM-K52) to end of part number. Example: DDM9SLNM-K52

## Dimensions-Right Angle 90° D Subminiature

Connectors with brackets cannot be ordered with float mounts or clinch nuts.

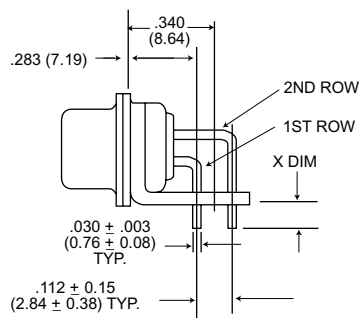

DE, DA, DB, DC Sizes

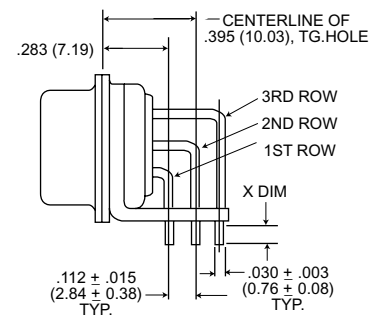

DD Size

Code Last Letter of P/N's	Right Angle With Bracket	X ± .027 (0.69)
D	•	.127 (3.22)
L	•	.158 (4.01)
S	•	.183 (4.65)

## PC Board Hole Patterns

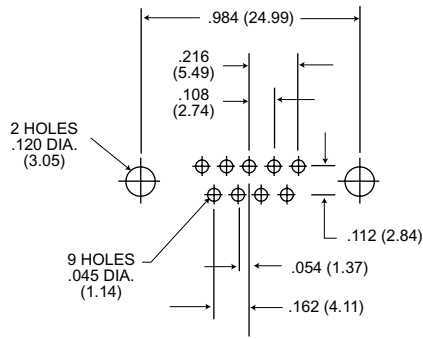

**DE Size**  
9 Positions

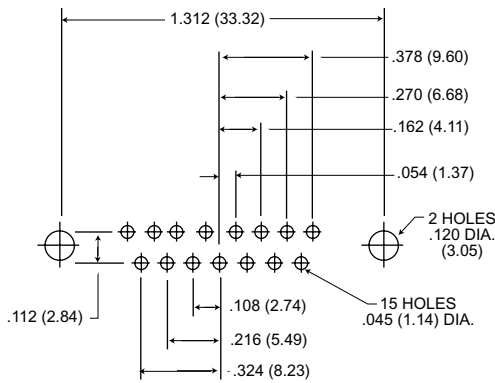

**DA Size**  
15 Positions

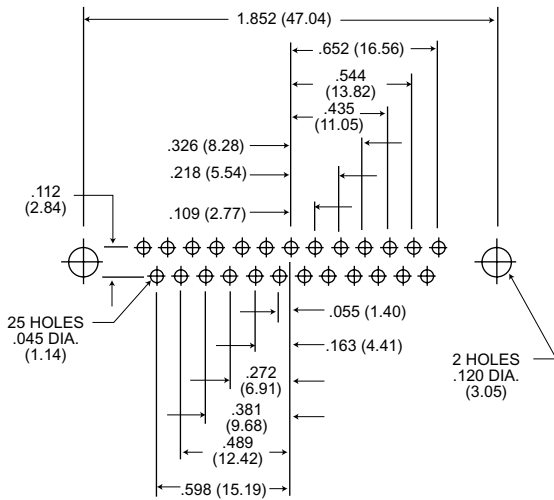

**DB Size**  
25 Positions

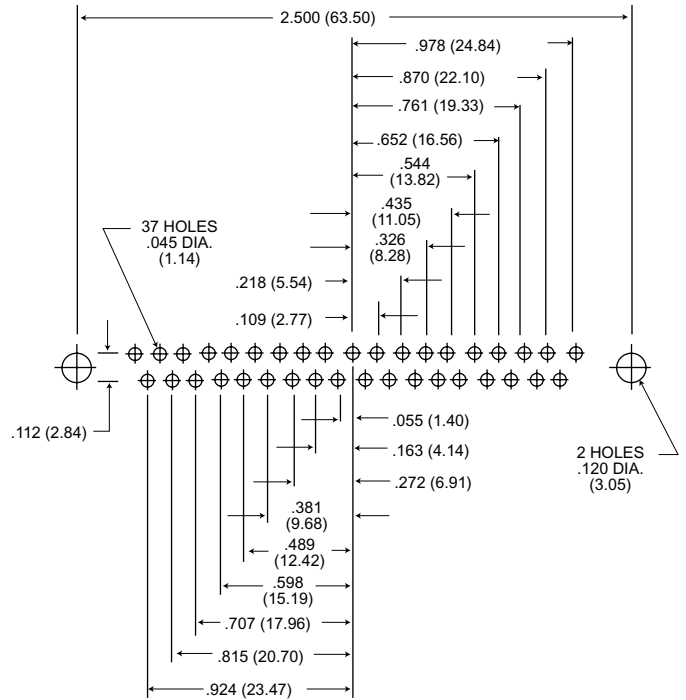

**DC Size**  
37 Positions

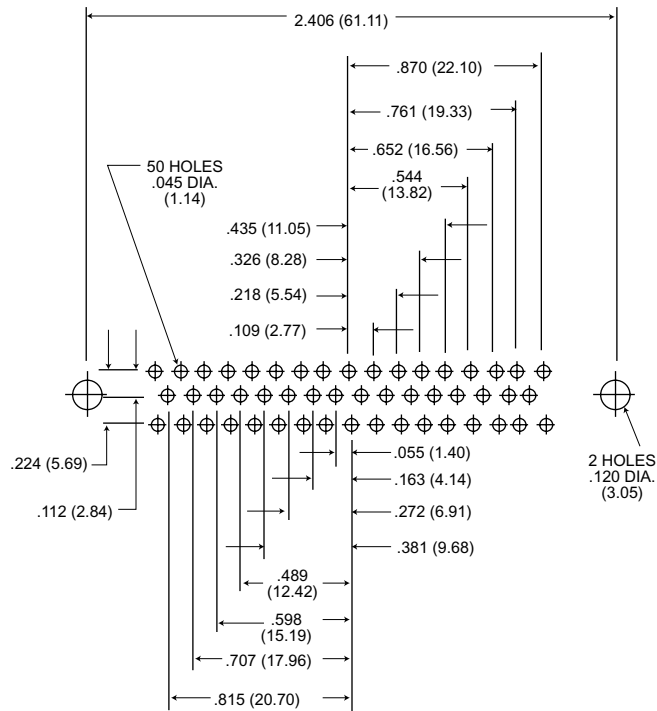

**DD Size**  
50 Positions

## MIL-C-24308 Cross Reference

Military Part Number	Cannon Part Number	Military Part Number	Cannon Part Number	Military Part Number	Cannon Part Number
M24308/1-1	DEMMS9S	M24308/2-485	DCMAMY37S-F0	M24308/6-5	DDMAM50SNM
M24308/1-2	DAMM15S	M24308/2-486	DDMAMY50S-F0	M24308/6-6	DEMAMT9SNM
M24308/1-3	DBMM25S	M24308/3-1	DEMMP9P	M24308/6-7	DAMAMT15SNM
M24308/1-4	DCMM37S	M24308/3-2	DAMM15P	M24308/6-8	DBMAMT25SNM
M24308/1-5	DDMM50S	M24308/3-3	DBMM25P	M24308/6-9	DCMAMT37SNM
M24308/1-12	DEMMP9S	M24308/3-4	DCMM37P	M24308/6-10	DDMAMT50SNM
M24308/1-13	DAMMF15S	M24308/3-5	DDMM50P	M24308/6-15	DDMAM78SNM
M24308/1-14	DBMMF25S	M24308/3-12	DEMMP9P	M24308/6-259	DEMAMF9SNM
M24308/1-15	DCMMF37S	M24308/3-13	DAMMF15P	M24308/6-260	DAMAMF15SNM
M24308/1-16	DDMMF50S	M24308/3-14	DBMMF25P	M24308/6-261	DBMAMF25SNM
M24308/1-23	DEMMY9S	M24308/3-15	DCMMF37P	M24308/6-262	DCMAMF37SNM
M24308/1-24	DAMMY15S	M24308/3-16	DDMMF50P	M24308/6-263	DDMAMF50SNM
M24308/1-25	DBMMY25S	M24308/4-1	DEMAM9P	M24308/6-268	DDMAMF78SNM
M24308/1-26	DCMMY37S	M24308/4-2	DAMAM15P	M24308/6-270	DEMAMFT9SNM
M24308/1-27	DDMMY50S	M24308/4-3	DBMAM25P	M24308/6-271	DAMAMFT15SNM
M24308/2-1	DEMAM9S	M24308/4-4	DCMAM37P	M24308/6-272	DBMAMFT25SNM
M24308/2-2	DAMAM15S	M24308/4-5	DDMAM50P	M24308/4-5	DDMAMFT37SNM
M24308/2-3	DBMAM25S	M24308/4-6	DEMAMT9P	M24308/4-6	DDMAMFT50SNM
M24308/2-4	DCMAM37S	M24308/4-7	DAMAMT15P	M24308/4-7	DEMAM9SNM-F0
M24308/2-5	DDMAM50S	M24308/4-8	DBMAMT25P	M24308/4-8	DAMAM15SNM-F0
M24308/2-6	DEMAMT9S	M24308/4-9	DCMAMT37P	M24308/4-9	DDMAM25SNM-F0
M24308/2-7	DAMAMT15S	M24308/4-10	DDMAMT50P	M24308/4-10	DCMAM37SNM-F0
M24308/2-8	DBMAMT25S	M24308/4-15	DDMAM78P	M24308/4-15	DDMAM50SNM-F0
M24308/2-9	DCMAMT37S	M24308/4-259	DEMAM9P-F0	M24308/4-259	DDMAM78SUM-F0
M24308/2-10	DDMAMT50S	M24308/4-260	DAMAM15P-F0	M24308/4-260	DEMAMF9SNM-F0
M24308/2-15	DDMAM78S	M24308/4-261	DBMAM25P-F0	M24308/4-261	DAMAMF15SNM-F0
M24308/2-23	DEMAMF9S	M24308/4-262	DCMAM37P-F0	M24308/4-262	DBMAMF25SNM-F0
M24308/2-24	DAMAMF15S	M24308/4-263	DDMAM50P-F0	M24308/4-263	DCMAMF37SNM-F0
M24308/2-25	DBMAMF25S	M24308/4-268	DDMAM78P-F0	M24308/4-268	DDMAMF50SNM-F0
M24308/2-26	DCMAMF37S	M24308/4-302	DEMAMF9P	M24308/4-302	DDMAMF78SNM-F0
M24308/2-27	DDMAMF50S	M24308/4-303	DAMAMF15P	M24308/4-303	DEMAMY9SNM
M24308/2-32	DDMAMF78S	M24308/4-304	DBMAMF25P	M24308/4-304	DAMAMY15SNM
M24308/2-34	DEMAMFT9S	M24308/4-305	DCMAMF37P	M24308/4-305	DBMAMY25SNM
M24308/2-35	DAMAMFT15S	M24308/4-306	DDMAMF50P	M24308/4-306	DCMAMY37SNM
M24308/2-36	DBMAMFT25S	M24308/4-311	DCMAMF78P	M24308/4-311	DDMAMY50SNM
M24308/2-37	DCMAMFT37S	M24308/4-313	DEMAMFT9P	M24308/4-313	DDMEMYT9SNM
M24308/2-38	DDMAMFT50S	M24308/4-314	DAMAMFT15P	M24308/4-314	DAMAMYT15SNM
M24308/2-281	DEMAM9S-F0	M24308/4-315	DBMAMFT25P	M24308/4-315	DBMAMYT25SNM
M24308/2-282	DAMAM15S-F0	M24308/4-316	DCMAMFT37P	M24308/4-316	DCMAMYT37SNM
M24308/2-283	DBMAM25S-F0	M24308/4-317	DDMAMFT50P	M24308/4-317	DDMAMYT50SNM
M24308/2-284	DCMAM37S-F0	M24308/4-324	DEMAMF9P-F0	M24308/4-324	DEMAMY9SNM-F0
M24308/2-285	DDMAM50S-F0	M24308/4-325	DAMAMF15P-F0	M24308/4-325	DAMAMY15SNM-F0
M24308/2-290	DDMAM78S-F0	M24308/4-326	DBMAMF25P-F0	M24308/4-326	DBMAMY25SNM-F0
M24308/2-292	DEMAMF9S-F0	M24308/4-327	DCMAMF37P-F0	M24308/4-327	DCMAMY37SNM-F0
M24308/2-293	DAMAMF15S-F0	M24308/4-328	DDMAMF50P-F0	M24308/4-328	DDMAMY50SNM-F0
M24308/2-294	DBMAMF25S-F0	M24308/4-333	DDMAMF78P-F0	M24308/7-1	DEMM9PNM
M24308/2-295	DCMAMF37S-F0	M24308/5-1	DEMMP9SNM	M24308/7-2	DAMM15PNM
M24308/2-296	DDMAMF50S-F0	M24308/5-2	DAMM15SNM	M24308/7-3	DBMM25PNM
M24308/2-301	DDMAMF78S-F0	M24308/5-3	DBMM25SNM	M24308/7-4	DCMM37PNM
M24308/2-335	DBMAMR25S	M24308/5-4	DCMM37SNM	M24308/7-5	DDMMS0PNM
M24308/2-336	DCMAMR37S	M24308/5-5	DDMM50SNM	M24308/7-12	DEMMP9PNM
M24308/2-341	DAMAMR15S	M24308/5-12	DEMMP9SNM	M24308/7-13	DAMMF15PNM
M24308/2-342	DEMAMY9S	M24308/5-13	DAMMF15SNM	M24308/7-14	DBMMF25PNM
M24308/2-343	DAMAMY15S	M24308/5-14	DBMMF25SNM	M24308/7-15	DCMMF37PNM
M24308/2-344	DBMAMY25S	M24308/5-15	DCMMF37SNM	M24308/7-16	DDMMF50PNM
M24308/2-345	DCMAMY37S	M24308/5-16	DDMMF50SNM	M24308/8-1	DEMAM9PNM
M24308/2-346	DDMAMY50S	M24308/5-23	DDMMY9SNM	M24308/8-2	DAMAM15PNM
M24308/2-353	DEMAMYT9S	M24308/5-24	DAMMY15SNM	M24308/8-3	DBMAM25PNM
M24308/2-354	DAMAMYT15S	M24308/5-25	DBMMY25SNM	M24308/8-4	DCMAM37PNM
M24308/2-355	DBMAMYT25S	M24308/5-26	DCMMY37SNM	M24308/8-5	DDMAM50PNM
M24308/2-356	DCMAMYT37S	M24308/5-27	DDMMY50SNM	M24308/8-6	DEMAMT9PNM
M24308/2-357	DDMAMYT50S	M24308/6-1	DEMAM9SNM	M24308/8-7	DAMAMT15PNM
M24308/2-482	DEMAMY9S-F0	M24308/6-2	DAMAM15SNM	M24308/8-8	DBMAMT25PNM
M24308/2-483	DEMAMY15S-F0	M24308/6-3	DBMAM25SNM	M24308/8-9	DCMAMT37PNM
M24308/2-484	DEMAMY25S-F0	M24308/6-4	DCMAM37SNM	M24308/8-10	DDMAMT50PNM



## MIL-C-24308 Cross Reference (Continued)

Military Part Number	Cannon Part Number	Military Part Number	Cannon Part Number	Military Part Number	Cannon Part Number
M24308/8-15	DDMAM78PNM	M24308/23-8	DAMM15SZ	M24308/24-8	DAMM15PZ
M24308/8-259	DEMAM9PNM-FO	M24308/23-9	DBMM25SZ	M24308/24-9	DBMM25PZ
M24308/8-260	DAMAM15PNM-FO	M24308/23-10	DCMM37SZ	M24308/24-10	DCMM37PZ
M24308/8-261	DBMAM25PNM-FO	M24308/23-11	DDMM50SZ	M24308/24-11	DDMM50PZ
M24308/8-262	DCMAM37PNM-FO	M24308/23-13	DEMM9SH	M24308/24-13	DEMM9PH
M24308/8-263	DDMAM50PNM-FO	M24308/23-14	DAMM15SH	M24308/24-14	DAMM15PH
M24308/8-269	DDMAM78PNM-FO	M24308/23-15	DBMM25SH	M24308/24-15	DBMM25PH
M24308/8-302	DEMAMF9PNM	M24308/23-16	DCMM37SH	M24308/24-16	DCMM37PH
M24308/8-303	DAMAMF15PNM	M24308/23-17	DDMM50SH	M24308/24-17	DDMM50PH
M24308/8-304	DBMAMF25PNM	M24308/23-19	DEMM9SX	M24308/24-19	DEMM9PX
M24308/8-305	DCMAMF37PNM	M24308/23-20	DAMM15SX	M24308/24-20	DAMM15FX
M24308/8-306	DDMAMF50PNM	M24308/23-21	DBMM25SX	M24308/24-21	DBMM25PX
M24308/8-311	DDMAMF78PNM	M24308/23-22	DCMM37SX	M24308/24-22	DCMM37PX
M24308/8-313	DEMAMFT9PNM	M24308/23-23	DDMM50SX	M24308/24-23	DDMM50PX
M24308/8-314	DAMAMFT15PNM	M24308/23-25	DEMM9SD	M24308/24-25	DEMM9PD
M24308/8-315	DBMAMFT25PNM	M24308/23-26	DAMM15SD	M24308/24-26	DAMM15PD
M24308/8-316	DCMAMFT37PNM	M24308/23-27	DBMM25SD	M24308/24-27	DBMM25PD
M24308/8-317	DDMAMFT50PNM	M24308/23-28	DCMM37SD	M24308/24-28	DCMM37PD
M24308/8-324	DEMAMF9PNM-FO	M24308/23-29	DDMM50SD	M24308/24-29	DDMM50PD
M24308/8-325	DAMAMF15PNM-FO	M24308/23-31	DEMM9SL	M24308/24-31	DEMM9PL
M24308/8-326	DBMAMF25PNM-FO	M24308/23-32	DAMM15SL	M24308/24-32	DAMM15PL
M24308/8-327	DCMAMF37PNM-FO	M24308/23-33	DBMM25SL	M24308/24-33	DBMM25PL
M24308/8-328	DDMAMF50PNM-FO	M24308/23-34	DCMM37SL	M24308/24-34	DCMM37PL
M24308/3-333	DDMAMF78PNM-FO	M24308/23-35	DDMM50SL	M24308/24-35	DDMM50PL
M24308/9-1	DEH9P002	M24308/23-37	DEMM9SA	M24308/24-37	DEMM9PA
M24308/9-2	DAH15P002	M24308/23-38	DAMM15SA	M24308/24-38	DAMM15PA
M24308/9-3	DBH25P002	M24308/23-39	DBMM25SA	M24308/24-39	DBMM25PA
M24308/9-4	DCH37P002	M24308/23-40	DCMM37SA	M24308/24-40	DCMM37PA
M24308/9-5	DDH50P002	M24308/23-41	DDMM50SA	M24308/24-41	DDMM50PA
M24308/9-6	DEH9P001	M24308/23-43	DEMM9SG	M24308/24-43	DEMM9PG
M24308/9-7	DAH15P001	M24308/23-44	DAMM15SG	M24308/24-44	DAMM15PG
M24308/9-8	DBH25P001	M24308/23-45	DBMM25SG	M24308/24-45	DBMM25PG
M24308/9-9	DCH37P001	M24308/23-46	DCMM37SG	M24308/24-46	DCMM37PG
M24308/9-10	DDH50P001	M24308/23-47	DDMM50SG	M24308/24-47	DDMM50PG
M24308/9-11	DEH9P202	M24308/23-49	DEMM9SS	M24308/24-49	DEMM9PS
M24308/9-12	DAH15P202	M24308/23-50	DAMM15SS	M24308/24-50	DAMM15PS
M24308/9-13	DBH25P202	M24308/23-51	DBMM25SS	M24308/24-51	DBMM25PS
M24308/9-14	DCH37P202	M24308/23-52	DCMM37SS	M24308/24-52	DCMM37PS
M24308/9-15	DDH50P202	M24308/23-53	DDMM50SS	M24308/24-53	DDMM50PS
M24308/9-16	DEH9P201	M24308/23-55	DEMM9SW	M24308/24-55	DEMM9PW
M24308/9-17	DAH15P201	M24308/23-56	DAMM15SW	M24308/24-56	DAMM15PW
M24308/9-18	DBH25P201	M24308/23-57	DBMM25SW	M24308/24-57	DBMM25PW
M24308/9-19	DCH37P201	M24308/23-58	DCMM37SW	M24308/24-58	DCMM37PW
M24308/9-20	DDH50P201	M24308/23-59	DDMM50SW	M24308/24-59	DDMM50PW
M24308/23-1	DEMM9SM	M24308/24-1	DEMM9PM	M24308/26-1	D20418-2
M24308/23-2	DAMM15SM	M24308/24-2	DAMM15PM	M24308/26-2	D20418-39
M24308/23-3	DBMM25SM	M24308/24-3	DBMM25PM		
M24308/23-4	DCMM37SM	M24308/24-4	DCMM37PM		
M24308/23-5	DDMM50SM	M24308/24-5	DDMM50PM		
M24308/23-7	DEMM9SZ	M24308/24-7	DEMM9PZ		

Crimp



(See page 342)

Printed Circuit



(See page 343)

## Performance and Material Specifications

### MATERIALS AND FINISHES

	Standard		Military	
	Material	Finish	Material	Finish
Shell	Steel per ASTM A-620	Yellow chromate over cadmium QQ-P-416 Type II Class 2	Steel per ASTM A-620	Yellow chromate over cadmium QQ-P-416 Type II Class 2
Insulator	Diallyl phthalate glass-filled per MIL-M-14, type SDG-F color green	-	Diallyl phthalate glass-filled per MIL-M-14, type SDG-F color green	-
Contact	Copper alloy	Gold over nickel	Copper alloy Crimp socket has stainless steel hood	Gold 50 microinches minimum thickness per MIL-G-45204 Type II Grade C Class 1 over copper per MIL-C-14550 Hood: Passivated
Float Mount Hardware	Stainless steel	Passivate per QQ-P-35	Stainless steel	Passivate per QQ-P-35

### PERFORMANCE SPECIFICATIONS

Wire Accommodation (AWG)	Crimp-#22-#28 AWG
Current Rating	#22: 5 Amp
Temperature Rating	-65°C to +150°C
Contact Resistance After Salt Spray, Millivolt Max.	55 @ 5 Amp test current

### DIELECTRIC WITHSTANDING VOLTAGE

Test	90° and Straight (Solder/Crimp)		
	Altitude (feet/m)		
	Sea Level	70,000/21,336	100,000
	1000	325	175

All voltage figures are rms AC 60 rms cps, measured at approximately +25°C, 50% rh. For additional performance specifications refer to MIL-C-24308 Test Extracts on page 385.

## Contact Arrangements

### Face View Pin Insert

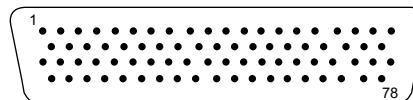

Shell Size  
Contact Arrangement  
Contact Size

D  
78  
#22

## How to Order - Crimp Connectors



### Receptacle (Includes Socket Contacts) With .120" Through-Mounting Holes

Number Contacts (Shell Size)	Standard Version	Military Version
78 (D)	DDMA78S	DDMAM78S

### Plugs (Includes Pin Contacts)\* With .120" Through-Mounting Holes

Number Contacts (Shell Size)	Standard Version	Military Version
78 (D)	DDMA78P	DDMAM78P

Note: 1) To receive the connector without contacts, add "FO" to end of part number.

Example: DBMA25SFO, DBMAM25SFO.  
2) For loose contacts and tooling see page 5.

### Mounting Options Available:

- 4-40 Clinch Nut - ADD "E" to Part Number After "M" or "A"
  - 4-40 Float Mount - Add "Y" to Part Number After "M" or "A"
- (Can be used in front or rear panel mount applications)

## Dimensions - Crimp Connectors

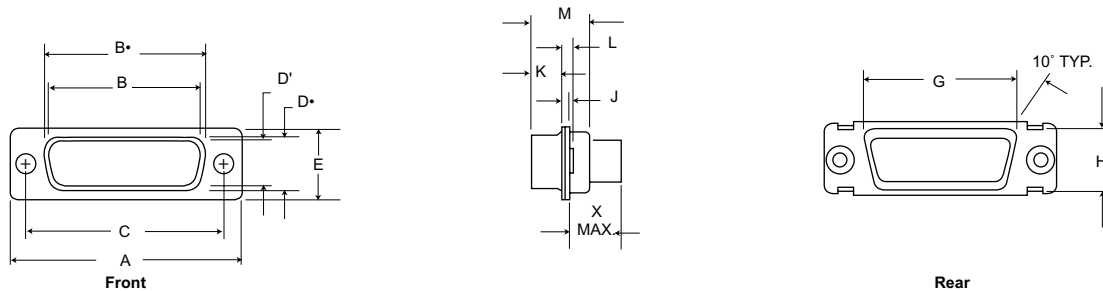

Part Number by Shell Size	A	B*	B'	C	D*	D'	E	G	H	J	K	L	M	X Max
DDM78P	2.635 (66.92)	-	2.079 (52.81)	2.406 (61.11)	-	.441 (11.20)	.605 (15.37)	2.178 (55.32)	.534 (13.56)	.039 (0.99)	.231 (5.87)	.060 (1.52)	.426 (10.82)	.345 (8.76)
DDM78S	2.635 (66.92)	2.064 (52.43)	-	2.406 (61.11)	.423 (10.41)	-	.605 (15.37)	2.178 (55.32)	.534 (13.56)	.030 (0.76)	.243 (6.17)	.045 (1.14)	.429 (10.90)	.345 (8.76)

## Mounting Option Dimensions

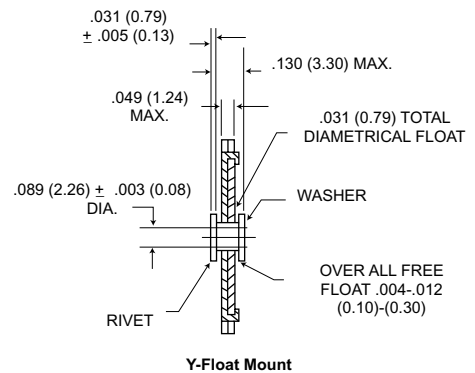
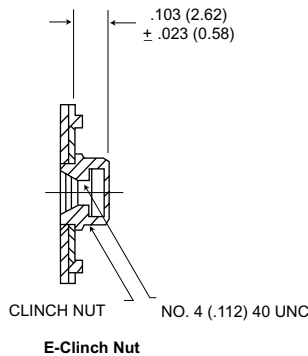
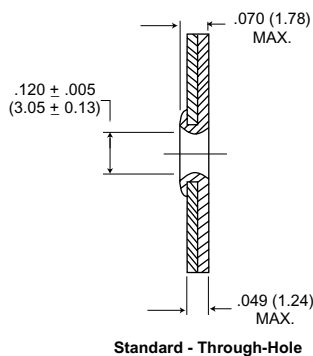

It is recommended that only on assembly, either pin or socket, be float mounted.

## High Rel Printed Circuit Mount Connector - Straight PC Tail



Receptacle



Plug

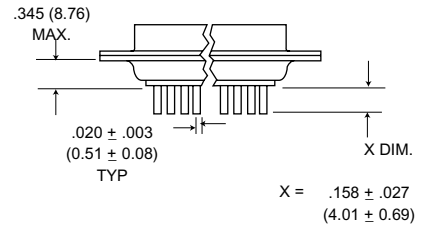

With .120 (3.15) Through-Mounting Holes

Number Contacts (Shell Size)		NM Non-Magnetic Receptacle		NM Non-Magnetic Plug	
		Receptacle		Plug	
78 (D) Standard		DDMA50913-499	-	DDMA50913-500	-
78 (D) Military		DDMA50913-439	DDMA50913-445	DDMA50913-440	DDMA50913-446

## High Rel 90° PCB Connectors



Receptacle



Plug

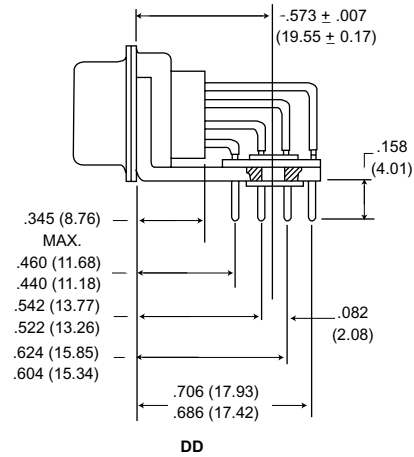

DD

Connectors with brackets cannot be ordered with float mounts or clinch nuts.

Number Contacts (Shell Size)		NM Non-Magnetic Receptacle		NM Non-Magnetic Plug	
		Receptacle		Plug	
78 (0) Standard		DDMA50913-467	-	DDMA50913-468	-
78 (0) Military		DDMA50913-437	DDMA50913-473	DDMA50913-438	DDMA50913-474

## High Rel Crimp Contacts

Contact Size	Wire Size Accommodation	Cannon Part Number			
		M39029	M24308*	Pin	Socket
22D Pin	22, 24, 26, 28	/58-360	/13-1	030-2042-00	-
22D Socket	22, 24, 26, 28	/57-354	/12-1	-	031-1147-000

\* Superseded by M39029

## Straight and 90° Board Hole Patterns

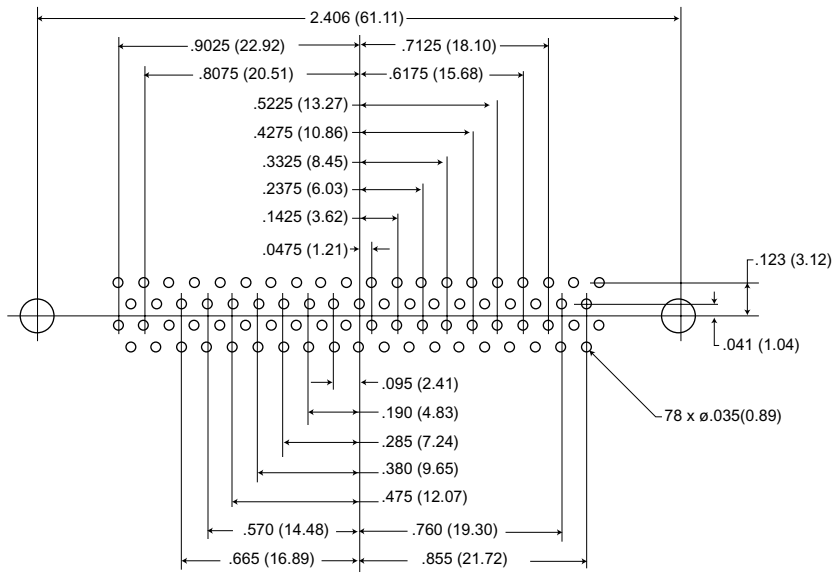

DD-78

## Tooling

Hand Tools

Contact Size	AWG	Plastic Insertion/Extraction	Crimp Tool	Locator
22D	22, 24, 26, 28	274-7048-000 CIET-22D	995-0001-584 M22520/2-01	995-0001-739 M22520/2-06

# Combo D<sup>®</sup>

Combination D Subminiature connectors are the fastest growing segment of the D Subminiature market. ITT Cannon engineering teams, in keeping pace with the demands of the industry, have developed the broadest selection of combination D Subminiature available.

We offer the ability to intergrate signal and coax, high power, and high voltage. You can mix red, green, and blue video lines with signal and up to 40 amps of power in the same package.

Design variations of the new Combo D connector, versus other packaging methods, include the proven ITT Cannon polarized "D" shape to prevent mis-mating; dense, space-saving packaging; and diverse mounting options. Choose from a variety of cable and printed wiring board selections. Printed wiring board combos come pre-assembled with fixed contacts eliminating the need to buy several components.

This new line of connectors offers you **unlimited design versatility**.



Straight and right angle printed wiring board contacts are available in both coax and high power versions.

## Performance and Material Specifications

### CONNECTOR ASSEMBLIES

Description	Material	Finish
Shell	Steel or Brass	Yellow Chromate Cadmium or Gold over Nickel
Insulator	Thermoplastic or Diallyl Phthalate, UL 94V-0 rated.	None
Size 20 contacts when applicable	Copper alloy	50μ inches gold over copper or 100μ gold over copper.
Bracket	Steel	Yellow Chromate over Cadmium
Rivnut	Steel or Copper alloy	

### COAXIAL ASSEMBLY

Description	Material	Finish
Contacts and shells	Copper alloy	Gold over nickel or 50μ inches gold over copper.
Ring, retaining	Copper alloy	Nickel or Gold
Insulator	Teflon	None

U.L. File Number: E8572

### DIELECTRIC WITHSTANDING VOLTAGE

Type of Contact		Altitude (feet/m)							
		Sea Level		20,000/6096		50,000/15240		70,000/1336	
		90'	Straight	90'	Straight	90'	Straight	90'	Straight
Center Conductor to Coaxial Shell	Average Flashover	1200	1500	900	1000	600	700	400	500
	Test	800	1000	600	650	400	475	275	325
Coaxial Shell to Nearest Standard Solder Pot Contact	Average Flashover	•	1500	•	1500	•	900	•	650
	Test	•	1000	•	1000	•	600	•	425
High Power contact and/or Coaxial Shell to Plug Shell	Average Flashover	1500	1500	1000	1000	500	500	500	500
	Test	1000	1000	650	650	325	325	325	325
#20 Signal	Average Flashover	1700		1000		650		500	
	Test	1250		750		475		375	
HV Contact to Nearest Contact or to Shell	Average Flashover	3800	3800	2300	2300	900	900	650	650
	Test	2800	2800	1700	1700	675	675	475	475

All voltage figures are rms AC 60 rms cps, measured at approximately +25°C, 50% rh.

Impedance: 50 ohm

### PERFORMANCE DATA

Signal Contact Current Rating	5 Amp
Temperature Rating	-65°C to +150°C
Signal Contact Resistance millivolt max	55 @ 7.5 Amp test current
Coax Impedance	50 ohm
Coax VSWR	Less than 1.3-1.0 up to 500 megahertz
Coax Insertion Loss	.1 db loss at 500 megahertz.

See *Commercial D Subminiature* catalog for additional Combo D options, including 75 ohm Coax.

# Combo D® - Coaxial/ 75 and 50 Ohm

## Coaxial Housing With Solder Cup Signal Contacts



- Cable combinations supplied with preloaded solder signal contacts
- 50 ohm coax contacts supplied separately (see pages 347-348)

Clinch Nut and Float Mount Options Available:

Add: E = 4-40 Clinch Nut

Y = Float Mounting

Example: DAMME3W3P

DANNT3W3P

Mounting Method Detail - Page 334.

Layout	Military Socket	Military Pin	NM Non-Magnetic Socket	NM Non-Magnetic Pin
DE-5W1	DEMMSW1S	DMM5W1P	DEM5W1S-NMB-K52	DEM5W1P-NMB-K52
DA-7W2	DAMM7W2S	DAMM7W2P	DAM7W2S-NMB-K52	DAM7W2P-NMB-K52
DA-11W1	DAMM11W1S	DAMM11W1P	DAM11W1S-NMB-K52	DAM11W1P-NMB-K52
DA-3W3	DAMM3W3S	DAMM3W3P	DAM3W3S-NMB-K47	DAM3W3P-NMB-K47
DB-5W5	DBMM5W5S	DBMM5W5P	DBM5W5S-NMB-K47	DBM5W5P-NMB-K47
DB-9W4	DBMM9W4S	DBMM9W4P	DBM9W4S-NMB-K52	DBM9W4P-NMB-K52
DB-13W3	DBMM13W3S	DBMM13W3P	DBM13W3S-NMB-K52	DBM13W3P-NMB-K52
DB-17W2	DBMM17W2S	DBMM17W2P	DBM17W2S-NMB-K52	DBM17W2P-NMB-K52
DB-21W1	DBMM21W1S	DBMM21W1P	DBM21W1S-NMB-K52	DBM21W1P-NMB-K52
DC-8W8	DCMM8W8S	DCMM8W8P	DCM8W8S-NMB-K47	DCM8W8P-NMB-K47
DC-13W6	DCMM13W6S	DCMM13W6P	DCM13W6S-NMB-K52	DCM13W6P-NMB-K52
DC-17W5	DCMM17W5S	DCMM17W5P	DCM17W5S-NMB-K52	DCM17W5P-NMB-K52
DC-21WA4	DCMM21WA4S	DCMM21WA4P	DCM21WA4S-NMB-K52	DCM21WA4P-NMB-K52
DC-25W3	DCMM25W3S	DCMM25W3P	DCM25W3S-NMB-K52	DCM25W3P-NMB-K52
DC-27W2	DCMM27W2S	DCMM27W2P	DCM27W2S-NMB-K52	DCM27W2P-NMB-K52
DD-24W7	DDMM24W7S	DDMM24W7P	DDM24W7S-NMB-K52	DDM24W7P-NMB-K52
DD-36W4	DDMM36W4S	DDMM36W4P	DDM36W4S-NMB-K52	DDM36W4P-NMB-K52
DD-43W2	DDMM43W2S	DDMM43W2P	DDM43W2S-NMB-K52	DDM43W2P-NMB-K52
DD-47W1	DDMM47W1S	DDMM47W1P	DDMC47W1S-NMB-K52	DDM47W1P-NMB-K52

## Contact Arrangements

(Will accommodate Removable Coax, Power and/or High Voltage Contacts)

Note: Color Code - Pin Connector: Red, Socket Connector: Blue

Shell Size	E	A	A	A	B	B
Contact Arrangement	5W1	3W3	7W2	11W1	5W5	9W4
No. of Signal Contacts	4 #20	0	5 #20	10 #20	0	5 #20
No. of Coaxial Contacts	1	3	2	1	5	4
Shell Size	B	B	B	C		
Contact Arrangement	13W3	17W2	21W1	8W8		
No. of Signal Contacts	10 #20	15 #20	20 #20	0		
No. of Coaxial Contacts	3	2	1	8		
Shell Size	C	C	C	C		
Contact Arrangement	13W6	17W5	21WA4	25W3		
No. of Signal Contacts	7 #20	12 #20	17 #20	22 #20		
No. of Coaxial Contacts	6	5	4	3		
Shell Size	C	D	D			
Contact Arrangement	27W2	24W7	36W4			
No. of Signal Contacts	25 #20	17 #20	32 #20			
No. of Coaxial Contacts	2	7	4			
Shell Size	D	D				
Contact Arrangement	43W2	47W1				
No. of Signal Contacts	41 #20	46 #20				
No. of Coaxial Contacts	2	1				

See *Commerical D Subminiature* catalog for additional Combo D options, including 75 ohm Coax.

# Combo D® - Coaxial/50 Ohm

## Cable Combinations - 50 Ohm Coaxial Contacts

Color Code: Receptacle - Blue; Plug - Red

Straight Crimp Braid

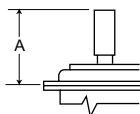

(Dimensions include outer sleeve).

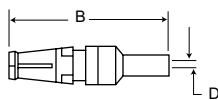

Receptacle

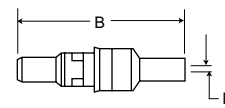

Plug

	Crimp/Crimp Gold Over Nickel	Gold Over Nickel	50µ in. Gold Over Copper	<i>NM</i> - Non-Magnetic 50µ in. Gold Over Copper	A Max.	B Max.	D Min.	RG Cable No.	
								Old	New
Plug		DM53740	DM53740-17		.739 (18.8)	.945 (24.00)	.040 (1.00)	196/U	178B/U
Plug	DM53740-37*	DM53740-1	DM53740-15	DM53740-36	.739 (18.8)	.945 (24.00)	.067 (1.70)	187/U	179B/U
Plug		DM53740-35			.739 (18.8)	.945 (24.00)	.067 (1.70)	-	RD316
Plug		DM53740-3	DM53740-16		.847 (21.5)	1.037 (26.34)	.110 (2.79)	195/U	180B/U
Plug		DM53740-5	DM53740-18		.847 (21.5)	1.037 (26.34)	.125 (3.18)	58/U	58B/U
Receptacle		DM53742	DM53742-18		.739 (18.8)	.945 (24.00)	.040 (1.00)	196/U	1788/U
Receptacle	DM53742-38*	DM53742-1	DM53742-16	DM53742-37	.739 (18.8)	.945 (24.00)	.067 (1.70)	187/U	179B/U
Receptacle		DM53742-36			.739 (18.8)	.945 (24.00)	.067 (1.70)	-	RD316
Receptacle		DM53742-3	DM53742-17		.847 (21.5)	1.037 (26.34)	.110 (2.79)	195/U	180B/U
Receptacle		DM53742-5	DM53742-19		.847 (21.5)	1.037 (26.34)	.125 (3.18)	58/U	58B/U

\* Consult factory for center contact crimp tooling.

Straight Crimp Braid

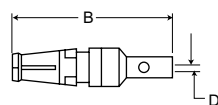
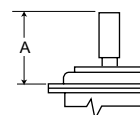

Receptacle

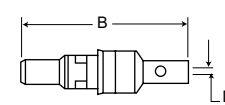

Plug

	Gold Over Nickel	50µ in. Gold Over Copper	<i>NM</i> - Non-Magnetic 50µ in. Gold Over Copper	A Max.	B Max.	D Min.	RG Cable No.	
							Old	New
Plug	DM53740-5008	DM53740-5105		.739 (18.8)	.945 (24.00)	.040 (1.00)	196/U	178B/U
Plug	DM53740-5001	DM53740-5099	DM53740-5147	.739 (18.8)	.945 (24.00)	.067 (1.70)	187/U	179B/U
Plug	DM53740-5145			.739 (18.8)	.945 (24.00)	.067 (1.70)	-	RD316
Plug	DM53740-5002	DM53740-5104		.847 (21.5)	1.037 (26.34)	.110 (2.79)	195/U	180B/U
Plug	DM53740-5005	DM53740-5101		.847 (21.5)	1.037 (26.34)	.125 (3.18)	58/U	58/U
Receptacle	DM53742-5006	DM53742-5092		.739 (18.8)	.945 (24.00)	.040 (1.00)	196/U	178B/U
Receptacle	DM53742-5001	DM53742-5089	DM53742-5127	.739 (18.8)	.945 (24.00)	.067 (1.70)	187/U	179B/U
Receptacle	DM53742-5126			.739 (18.8)	.945 (24.00)	.067 (1.70)	-	RD316
Receptacle	DM53742-5002	DM53742-5091		.847 (21.5)	1.037 (26.34)	.110 (2.79)	195/U	180B/U
Receptacle	DM53742-5004	DM53742-5086		.847 (21.5)	1.037 (26.34)	.125 (3.18)	58/U	58/U
Plug (Short Type)	DM53740-5000	DM53740-5100	.670 (17.0)	.874 (22.20)	.045 (1.14)	.196/U	178B/U	
Receptacle (Short Type)	DM53742-5000	DM53742-5085	.670 (17.0)	.874 (22.20)	.045 (1.14)	.196/U	178B/U	

Right Angle Solder Braid

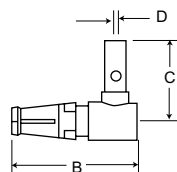
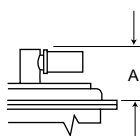

Receptacle

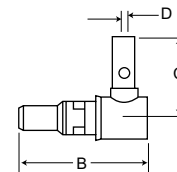

Plug

	Gold Over Nickel	50µ in. Gold Over Copper	A Max.	B Max.	C	D Min.	RG Cable No.	
							Old	New
Plug	DM53741-5000	DM53741-5059	.530 (13.46)	.745 (18.92)	.544 (15.10)	.040 (1.00)	196/U	178B/U
Plug	DM53741-5001	DM53741-5062	.530 (13.46)	.745 (18.92)	.544 (15.10)	.067 (1.70)	187/U 188/U	178B/U 316B/U
Plug	DM53741-5003	DM53741-5063	.530 (13.46)	.745 (18.92)	.630 (16.00)	.110 (2.79)	195/U	180B/U
Plug	DM53741-5004	DM53741-5060	.530 (13.46)	.745 (18.92)	.630 (16.00)	.125 (3.18)	58/U	58/U
Receptacle	DM53743-5000	DM53743-5073	.530 (13.46)	.745 (18.92)	.594 (15.09)	.040 (1.00)	196/U	178B/U
Receptacle	DM53743-5001	DM53743-5076	.530 (13.46)	.745 (18.92)	.594 (15.09)	.067 (1.70)	187/U 188/U	179B/U 316B/U
Receptacle	DM53743-5003	DM53743-5077	.530 (13.46)	.745 (18.92)	.630 (16.00)	.110 (2.79)	195/U	180B/U
Receptacle	DM53743-5004	DM53743-5074	.530 (13.46)	.745 (18.92)	.630 (16.00)	.125 (3.18)	58/U	58B/U

Highlighted part numbers indicate standard product; usually available with shorter lead times.

See *Commerical D Subminiature* catalog for additional Combo D options, including 75 ohm Coax.



# Combo D® - Coaxial/50 Ohm

## Cable Combinations - 50 Ohm Coaxial Contacts (Continued)

### Right Angle Crimp Braid

(Dimensions include outer sleeve.)  
Color Code: Receptacle - Blue; Plug - Red

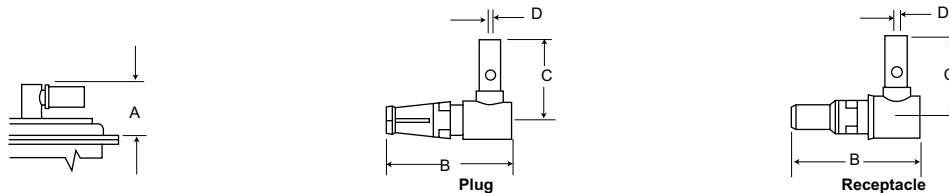

	Part Number		A Max.	B Ref.	C	D ± .005 (0.13)	RG Cable No.	
	Gold Over Nickel	50µ in. Gold Over Copper					Old	New
Plug	DM53741	DM53741-12	.530 (13.46)	.745 (18.92)	.594 (15.10)	.045 (1.14)	196/U	178B/U
Plug	DM53741-1	DM53741-11	.530 (13.46)	.745 (18.92)	.594 (15.10)	.072 (1.83)	187/U	179B/U
							188/U	316B/U
Plug	DM53741-3	DM53741-10	.530 (13.46)	.745 (18.92)	.630 (16.00)	.110 (2.79)	195/U	180B/U
Plug	DM53741-4	DM53741-13	.530 (13.46)	.745 (18.92)	.630 (16.00)	.125 (3.18)	58/U	58B/U
Receptacle	DM53743-2	DM53743-18	.530 (13.46)	.745 (18.92)	.594 (15.10)	.045 (1.14)	196/U	178B/U
Receptacle	DM53743-3	DM53743-16	.530 (13.46)	.745 (18.92)	.594 (15.10)	.072 (1.83)	187/U	179B/U
							188/U	316B/U
Receptacle	DM53743-5	DM53743-17	.530 (13.46)	.745 (18.92)	.630 (16.00)	.110 (2.79)	195/U	180B/U
Receptacle	DM53743-6	DM53743-19	.530 (13.46)	.745 (18.92)	.630 (16.00)	.125 (3.18)	58/U	58B/U

## Insertion/Extraction Instructions

### Coaxial, High Power and High Voltage Contacts

#### Insertion

No insertion tool is required. The contact is easily snapped in from the rear of the connector.

**RED COLOR CODED CONNECTOR**  
ACCEPTS PLUG CONTACTS.

**BLUE COLOR CODED CONNECTORS** ACCEPTS RECEPTACLE  
CONTACTS INSERT FROM TERMINAL END AS SHOWN BELOW.

INSERT

INSERT

PLUG CONTACT  
D\*M PLUG

RECEPTACLE CONTACT  
D\*M RECEPTACLE

#### Extraction

#### CET-C6B

The CET-C6B tool extracts coaxial, high power and high voltage contacts (Plug and receptacle). Part number 070064-0000.

#### Operating Instructions:

To extract the coax contact, hold the tool by the body and insert the tip into the front of the contact cavity until it bottoms and closes the coax retaining ring. Holding the body in this position securely enough to keep coax retaining ring closed, push the plunger; contact will be pushed out of the rear of the assembly.

TOOL PLUNGER  
COAXIAL, H.V., OR  
POWER CONTACTS  
EXTRACT  
  
TOOL TIP  
EXTRACTION TOOL CET-C6B

**Hand Tool** with intergral die set for all coax straight crimp braid. Part Number: 070051-0000 (CCT-DM)

See *Commerical D Subminiature* catalog for additional Combo D options, including 75 ohm Coax.

# Combo D® - Coaxial/50 Ohm

## Coax Assembly Instructions

### Trim Dimensions

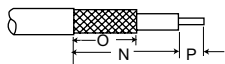

RG Cable No.	Straight			Right Angle		
	N	O	P	N	O	P
196/U, 178B/U, 187/U 188/U, 179B/U, 316B/U	.312 (7.92)	.250 (6.35)	.078 (1.98)	.375 (9.52)	.234 (5.94)	.062 (1.57)
195/U, 180B/U 58/U, 58B/U	.375 (9.52)	.312 (7.92)	.078 (1.98)	.422 (10.69)	.312 (7.92)	.094 (2.39)

All tolerances  $\pm .010$  (0.25)

### Crimp Tooling

RG Cable No.	Tool P/N	Description	Closure
196/U, 178B/U	070051-0000	CCT-DM	C
187/U, 179B/U 188/U, 316B/U	070051-0000	CCT-DM	B
195/U, 180B/U 58/U, 58B/U	070051-0000	CCT-DM	A

### 90° Coaxial

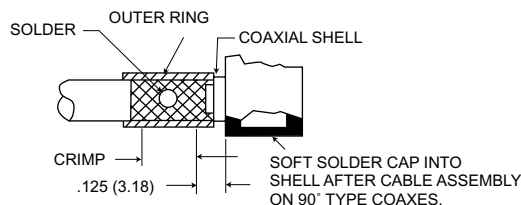
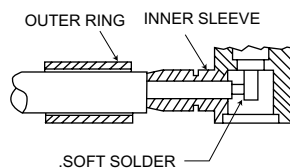

### Straight Coaxial

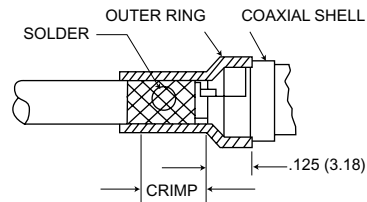
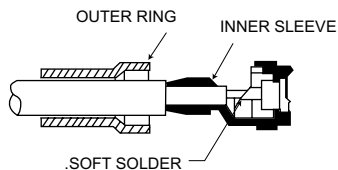

### STEP 1: Straight and 90° Coaxials

Slide the outer ring over the cable jacket. Trim the cable as specified in the table of Coax Cable Trim Dimensions. Insert the cable dielectric and center conductor into the inside diameter of the inner sleeve. Then solder the center conductor to the coax center contact.

### STEP 2: Straight and 90° Coaxials

Slide the outer ring forward until it is flush with the coax shell containing the braid between the outer ring and the inner sleeve. For solder type coaxes, soft solder the outer ring to the assembly through the cross-drilled solder hold. For crimp type coaxes, crimp with the appropriate tool in the area defined.

See *Commerical D Subminiature* catalog for additional Combo D options, including 75 ohm Coax.

# Combo D® - Coaxial/50 Ohm

## Right Angle Receptacle for PCB Mounting



PCB Layouts - Page 352

Military part numbers come complete with fixed, female, signal and coaxial contacts and right angle brackets.

Military part numbers come with coaxial contacts.

Non-magnetic part numbers must use coaxial contacts from Page 347 and do not come with brackets.

Layout	Military	<b>NM</b> Non-Magnetic
DE-5W1	DEMMP5X1SP	DEM5W1SP-NMB-K52
DA-7W2	DAMMP7X2SP	DAM7W2SP-NMB-K52
DA-11W1	DAMMP11X1SP	DAM11W1SP-NMB-K52
DA-3W3	DAMMP3X3SP	DAM3W3SP-NMB-K47
DB-5W5	DBMMP5X5SP	DBM5W5SP-NMB-K47
DB-9W4	DBMMP9X4SP	DBM9W4SP-NMB-K52
DB-13W3	DBMMP13X3SP	DBM13W3SP-NMB-K52
DB-17W2	DBMMP17X2SP	DBM17W2SP-NMB-K52
DB-21W1	DBMMP21X1SP	DBM21W1SP-NMB-K52
DC-8W8	DCMMP8X8SP	DCM8W8SP-NMB-K47
DC-13W6	DCMMP13X6SP	DCM13W6SP-NMB-K52
DC-17W5	DCMMP17X5SP	DCM17W5SP-NMB-K52
DC-21WA4	DCMMP21XA4SP	DCM21WA4SP-NMB-K52
DC-25W3	DCMMP25X3SP	DCM25W3SP-NMB-K52
DC-27W2	DCMMP27X2SP	DCM27W2SP-NMB-K52

## Dimensions

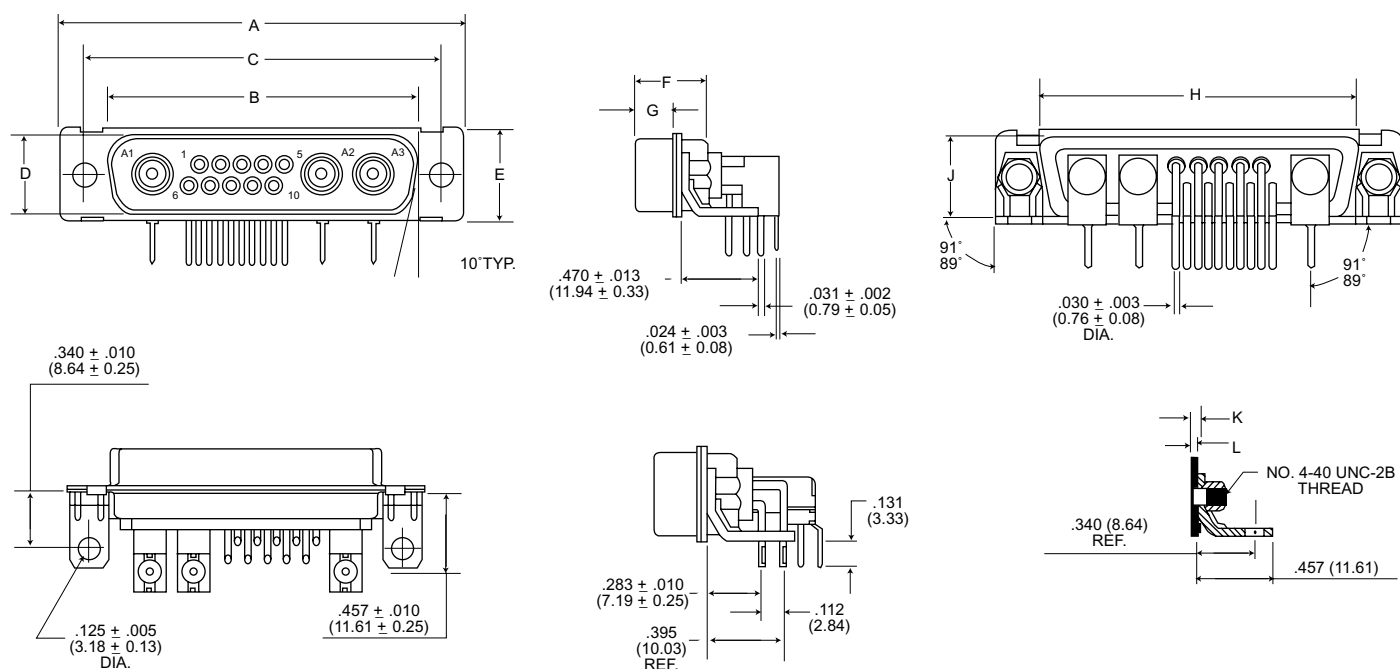

## SOCKET CONNECTOR ASSEMBLY (Female)

Shell Size	A ± .015 (0.38)	B ± .005 (0.13)	C ± .005 (0.13)	D ± .005 (0.13)	E ± .015 (0.38)	F ± .005 (0.13)	G ± .005 (0.13)	H ± .010 (0.25)	J ± .010 (0.25)	K ± .013 (0.33)	L ± .010 (0.25)
DE	1.213 (30.81)	.643 (16.33)	.984 (24.99)	.311 (7.90)	.494 (12.55)	.429 (10.90)	.243 (6.17)	.759 (19.28)	.422 (10.72)	.048 (1.22)	.030 (0.76)
DA	1.541 (39.14)	.971 (24.66)	1.312 (33.32)	.311 (7.90)	.494 (12.55)	.429 (10.90)	.243 (6.17)	1.083 (27.51)	.422 (10.72)	.048 (1.22)	.030 (0.76)
DB	2.088 (53.03)	1.511 (38.38)	1.852 (47.04)	.311 (7.90)	.494 (12.55)	.429 (10.90)	.243 (6.17)	1.625 (41.27)	.422 (10.72)	.048 (1.22)	.039 (0.99)
DC	2.729 (69.31)	2.159 (54.84)	2.500 (63.50)	.311 (7.90)	.494 (12.55)	.429 (10.90)	.243 (6.17)	2.272 (57.71)	.422 (10.72)	.048 (1.22)	.039 (0.99)

See *Commerical D Subminiature* catalog for additional Combo D options, including 75 ohm Coax.

# Combo D® - Coaxial/50 Ohm

## Right Angle Plug for PCB Mounting



PCB Layouts - Page 352

Military part numbers come complete with fixed, female, signal and right angle brackets.

Military part numbers come with coaxial contacts.

Non-magnetic part numbers must use coaxial contacts from Page 347 and do not come with brackets.

Layout	Military	<b>NM</b> Non-Magnetic
DE-5W1	DEMMP5X1PP	DEM5W1PP-NMB-K52
DA-7W2	DAMMP7X2PP	DAM7W2PP-NMB-K52
DA-11W1	DAMM11X1PP	DAM11W1PP-NMB-K52
DA-3W3	DAMM3X3PP	DAM3W3P-NMB-K47
DB-5W5	DBMM5X5PP	DBM5W5P-NMB-K47
DB-9W4	DBMM9X4PP	DBM9W4PP-NMB-K52
DB-13W3	DBMM13X3PP	DBM13W3PP-NMB-K52
DB-17W2	DBMM17X2PP	DBM17W2PP-NMB-K52
DB-21W1	DBMM21X1PP	DBM21W1PP-NMB-K52
DC-8W8	DCMM8X8PP	DCM8W8P-NMB-K47
DC-13W6	DCMM13X6PP	DCM13W6PP-NMB-K52
DC-17W5	DCMM17X5PP	DCM17W5PP-NMB-K52
DC-21WA4	DCMM21XA4PP	DCM21WA4PP-NMB-K52
DC-25W3	DCMM25X3PP	DCM25W3PP-NMB-K52
DC-27W2	DCMM27X2PP	DCM27W2PP-NMB-K52

## Dimensions

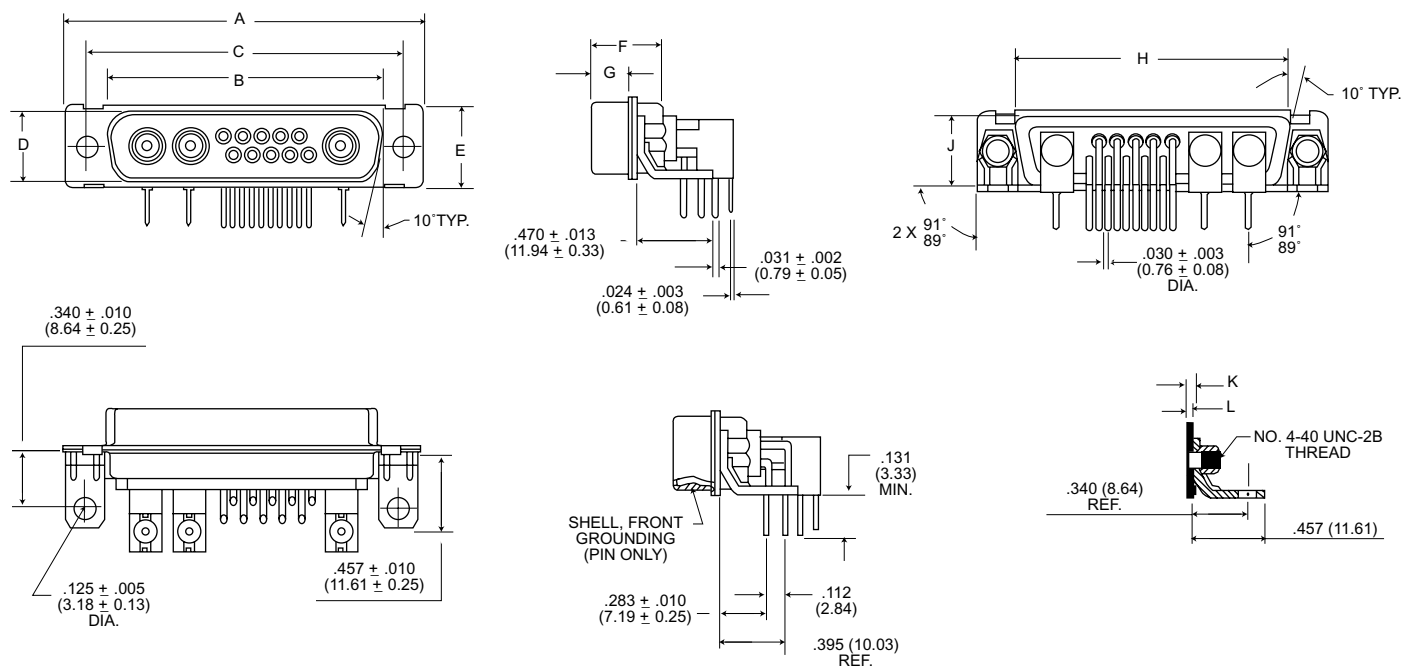

## PLUG CONNECTOR ASSEMBLY (Male)

Shell Size	A + .015 (0.38)	B + .005 (0.13)	C + .005 (0.13)	D + .005 (0.13)	E + .015 (0.38)	F + .005 (0.13)	G + .006 (0.15)	H + .010 (0.25)	J + .010 (0.25)	K + .013 (0.33)	L + .010 (0.25)
DE	1.213 (30.81)	.666 (16.91)	.984 (24.99)	.329 (8.36)	.494 (12.55)	.422 (10.72)	.236 (5.99)	.759 (19.28)	.422 (10.72)	.048 (1.22)	.030 (0.76)
DA	1.541 (39.14)	.994 (25.24)	1.312 (33.32)	.329 (8.36)	.494 (12.55)	.422 (10.72)	.236 (5.99)	1.083 (27.51)	.422 (10.72)	.048 (1.22)	.030 (0.76)
DB	2.088 (53.03)	1.534 (38.96)	1.852 (47.04)	.329 (8.36)	.494 (12.55)	.426 (10.82)	.231 (5.87)	1.625 (41.27)	.422 (10.72)	.060 (1.52)	.039 (0.99)
DC	2.729 (69.31)	2.182 (55.42)	2.500 (63.50)	.329 (8.36)	.494 (12.55)	.426 (10.82)	.231 (5.87)	2.272 (57.71)	.422 (10.72)	.060 (1.52)	.039 (0.99)

See *Commerical D Subminiature* catalog for additional Combo D options, including 75 ohm Coax.

# Combo D® - Coaxial

## Right Angle Printed Circuit Board Hole Patterns

Face view, pin insert  
(for receptacle, hole pattern is a mirror image)

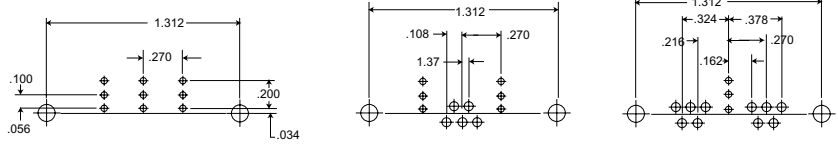
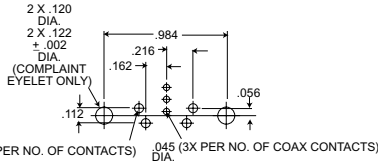

Shell Size **E**  
Contact Arrangement **5W1**  
No. of Signal Contacts **4 #20**  
No. of Coaxial Contacts **1**

Shell Size **A**  
Contact Arrangement **3W3**  
No. of Signal Contacts **0**  
No. of Coaxial Contacts **3**

Shell Size **A**  
Contact Arrangement **7W2**  
No. of Signal Contacts **5 #20**  
No. of Coaxial Contacts **2**

Shell Size **A**  
Contact Arrangement **11W1**  
No. of Signal Contacts **10 #20**  
No. of Coaxial Contacts **1**

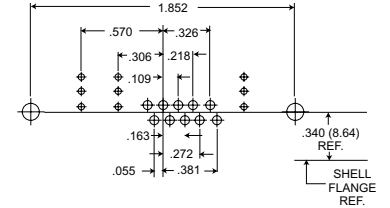
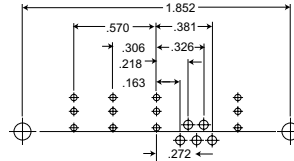
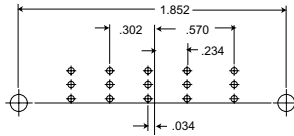

Shell Size **B**  
Contact Arrangement **5W5**  
No. of Signal Contacts **0**  
No. of Coaxial Contacts **5**

Shell Size **B**  
Contact Arrangement **9W4**  
No. of Signal Contacts **5 #20**  
No. of Coaxial Contacts **4**

Shell Size **B**  
Contact Arrangement **13W3**  
No. of Signal Contacts **10 #20**  
No. of Coaxial Contacts **3**

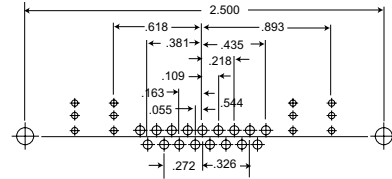
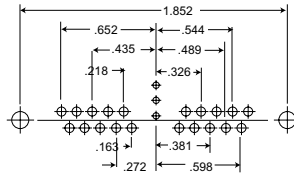
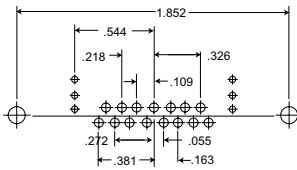

Shell Size **B**  
Contact Arrangement **17W2**  
No. of Signal Contacts **15 #20**  
No. of Coaxial Contacts **2**

Shell Size **B**  
Contact Arrangement **21W1**  
No. of Signal Contacts **20 #20**  
No. of Coaxial Contacts **1**

Shell Size **C**  
Contact Arrangement **21WA4**  
No. of Signal Contacts **17 #20**  
No. of Coaxial Contacts **4**

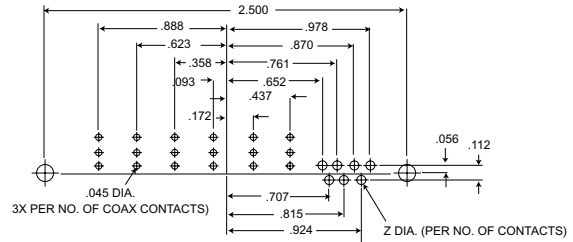
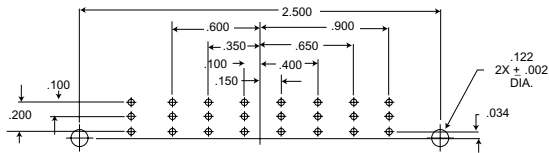

Shell Size **C**  
Contact Arrangement **8W8**  
No. of Signal Contacts **0**  
No. of Coaxial Contacts **8**

Shell Size **C**  
Contact Arrangement **13W6**  
No. of Signal Contacts **7 #20**  
No. of Coaxial Contacts **6**

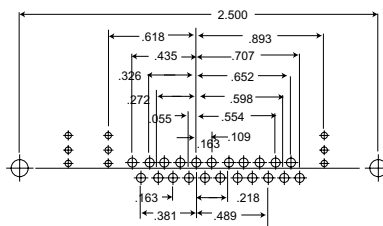
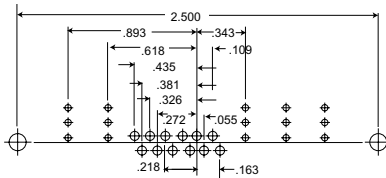

Shell Size **C**  
Contact Arrangement **17W5**  
No. of Signal Contacts **12 #20**  
No. of Coaxial Contacts **5**

Shell Size **C**  
Contact Arrangement **25W3**  
No. of Signal Contacts **22 #20**  
No. of Coaxial Contacts **3**

Size #20 Contact PC Tail Dia.	Z Dia.
.030 (0.76)	.045 (1.14)

See *Commerical D Subminiature* catalog for additional Combo D options, including 75 ohm Coax.

# Combo D® - Coaxial/50 Ohm

## Straight Receptacle for PCB Mounting



PCB Hole Patterns - Pages 354-355

Part numbers come complete with fixed, female, signal and coaxial contacts.

Layout	Military	NM Non-Magnetic
DE-5W1	DEMM5X1SM	DEM5X1SM-NM-K52
DA-7W2	DAMM7X2SM	DAM7X2SM-NM-K52
DA-11W1	DAMM11X1SM	DAM11X1SM-NM-K52
DA-3W3	DAMM3X3SM	DAM3X3SM-NM-K52
DB-5W5	DBMM5X5SM	DBM5X5SM-NM-K52
DB-9W4	DBMM9X4SM	DBM9X4SM-NM-K52
DB-13W3	DBMM13X3SM	DBM13X3SM-NM-K52
DB-17W2	DBMM17X2SM	DBM17X2SM-NM-K52
DB-21W1	DBMM21X1SM	DBM21X1SM-NM-K52
DC-8W8	DCMM8X8SM	DCM8X8SM-NM-K52
DC-13W6	DCMM13X6SM	DCM13X6SM-NM-K52
DC-17W5	DCMM17X5SM	DCM17X5SM-NM-K52
DC-21WA4	DCMM21XA4SM	DCM21XA4SM-NM-K52
DC-25W3	DCMM25X3SM	DCM25X3SM-NM-K52
DD-24W7	DCMM24X7SM	DCM24X7SM-NM-K52
DC-27W2	DCMM27X2SM	DCM27X2SM-NM-K52
DD-24W7	DDMM24X7SM	DDM24X7SM-NM-K52
DD-36W4	DDMM36X4SM	DDM36X4SM-NM-K52
DD-43W2	DDMM43X2SM	DDM43X2SM-NM-K52
DD-47W1	DDMM47X1SM	DDMC47X1SM-NM-K52

## Straight Plug for PCB Mounting (Board Thickness up to .125 [3.18])



PCB Hole Patterns - Pages 354-355

Part numbers come complete with fixed, male, signal and coaxial contacts.

Layout	Military	NM Non-Magnetic
DE-5W1	DEMM5X1PM	DEM5X1PM-NM-K52
DA-7W2	DAMM7X2PM	DAM7X2PM-NM-K52
DA-11W1	DAMM11X1PM	DAM11X1PM-NM-K52
DA-3W3	DAMM3X3PM	DAM3X3PM-NM-K52
DB-5W5	DBMM5X5PM	DBM5X5PM-NM-K52
DB-9W4	DBMM9X4PM	DBM9X4PM-NM-K52
DB-13W3	DBMM13X3PM	DBM13X3PM-NM-K52
DB-17W2	DBMM17X2PM	DBM17X2PM-NM-K52
DB-21W1	DBMM21X1PM	DBM21X1PM-NM-K52
DC-8W8	DCMM8X8PM	DCM8X8PM-NM-K52
DC-13W6	DCMM13X6PM	DCM13X6PM-NM-K52
DC-17W5	DCMM17X5PM	DCM17X5PM-NM-K52
DC-21WA4	DCMM21XA4PM	DCM21XA4PM-NM-K52
DC-25W3	DCMM25X3PM	DCM25X3PM-NM-K52
DC-27W2	DCMM27X2PM	DCM27X2PM-NM-K52
DD-24W7	DDMM24X7PM	DDM24X7PM-NM-K52
DD-36W4	DDMM36X4PM	DDM36X4PM-NM-K52
DD-43W2	DDMM43X2PM	DDM43X2PM-NM-K52
DD-47W1	DDMM47X1PM	DDM47X1PM-NM-K52

### Dimensions

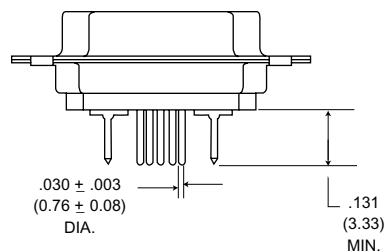

See *Commerical D Subminiature* catalog for additional Combo D options, including 75 ohm Coax.

# Combo D® - Coaxial

## Straight Printed Circuit Board Hole Patterns

Face view, pin insert  
(for receptacle, hole pattern is a mirror image)

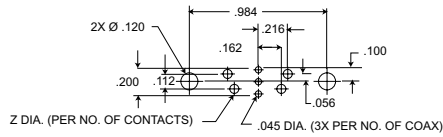

Shell Size **E**  
Contact Arrangement **5W1**  
No. of Signal Contacts **4 #20**  
No. of PC Coaxial Contacts **1**

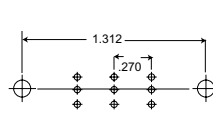

Shell Size **A**  
Contact Arrangement **3W3**  
No. of Signal Contacts **-**  
No. of PC Coaxial Contacts **3**

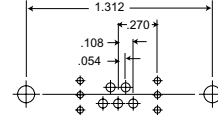

Shell Size **A**  
Contact Arrangement **7W2**  
No. of Signal Contacts **5 #20**  
No. of PC Coaxial Contacts **2**

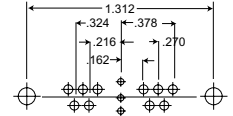

Shell Size **A**  
Contact Arrangement **11W1**  
No. of Signal Contacts **10 #20**  
No. of PC Coaxial Contacts **1**

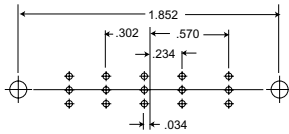

Shell Size **B**  
Contact Arrangement **5W5**  
No. of Signal Contacts **-**  
No. of PC Coaxial Contacts **5**

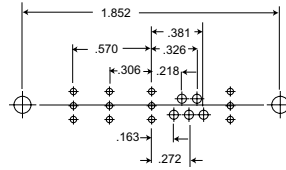

Shell Size **B**  
Contact Arrangement **9W4**  
No. of Signal Contacts **5 #20**  
No. of PC Coaxial Contacts **4**

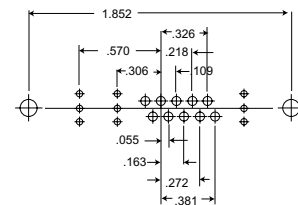

Shell Size **B**  
Contact Arrangement **13W3**  
No. of Signal Contacts **10 #20**  
No. of PC Coaxial Contacts **3**

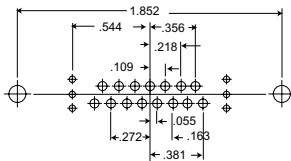

Shell Size **B**  
Contact Arrangement **17W2**  
No. of Signal Contacts **15 #20**  
No. of PC Coaxial Contacts **2**

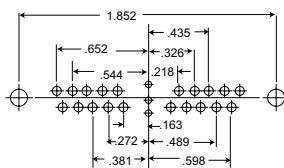

Shell Size **B**  
Contact Arrangement **21W1**  
No. of Signal Contacts **20 #20**  
No. of PC Coaxial Contacts **1**

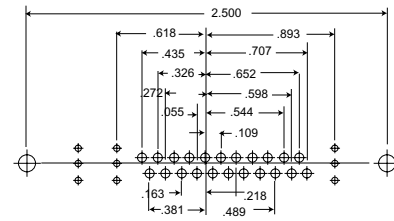

Shell Size **C**  
Contact Arrangement **25W3**  
No. of Signal Contacts **22 #20**  
No. of PC Coaxial Contacts **3**

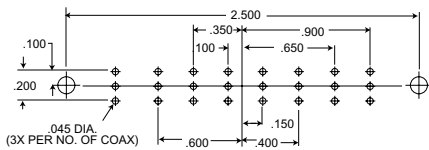

Shell Size **C**  
Contact Arrangement **8W8**  
No. of Signal Contacts **-**  
No. of PC Coaxial Contacts **8**

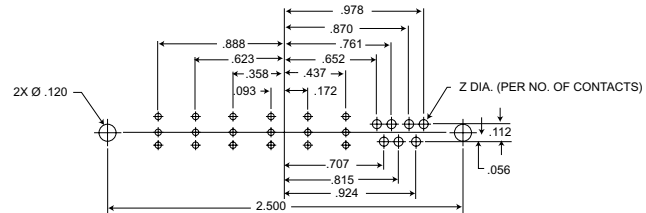

Shell Size **C**  
Contact Arrangement **13W6**  
No. of Signal Contacts **7 #20**  
No. of PC Coaxial Contacts **6**

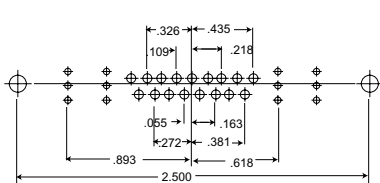

Shell Size **C**  
Contact Arrangement **21WA4**  
No. of Signal Contacts **17 #20**  
No. of PC Coaxial Contacts **4**

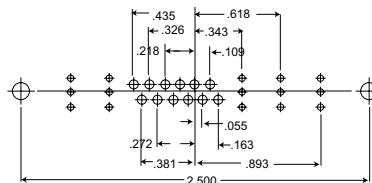

Shell Size **C**  
Contact Arrangement **17W5**  
No. of Signal Contacts **12 #20**  
No. of PC Coaxial Contacts **5**

Size No. 20	2
Contact PC	
Tail Dia.	Dia.
.030 (0.76)	.045 (1.14)

# Combo D® - Coaxial

## Straight Printed Circuit Board Hole Patterns

Face view, pin insert  
(for receptacle, hole pattern is a mirror image)

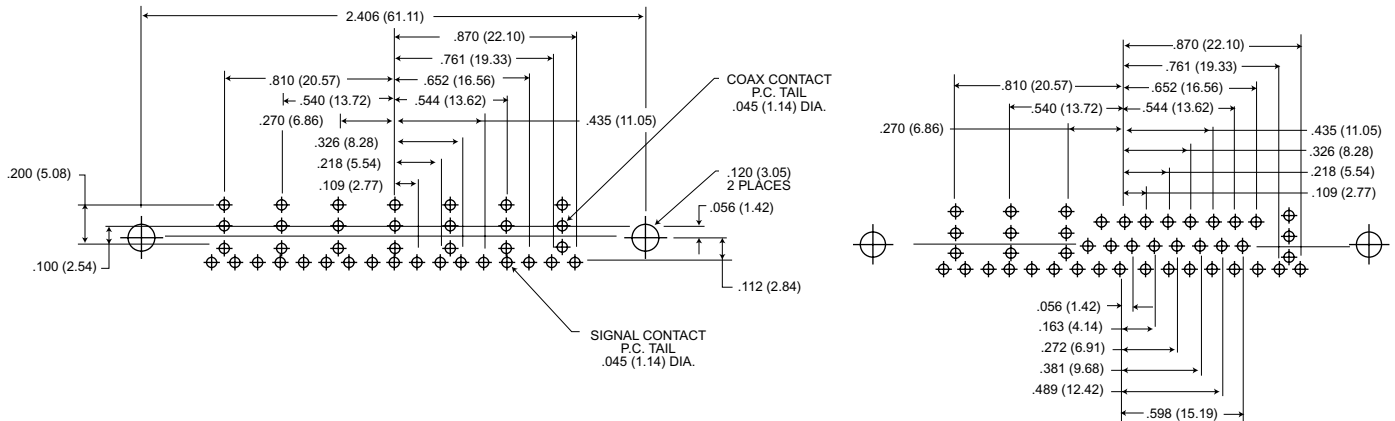

Shell Size **D**  
Contact Arrangement **24W7**  
No. of Signal Contacts **17 #20**  
No. of Coaxial Contacts **7**

Shell Size **D**  
Contact Arrangement **36W4**  
No. of Signal Contacts **32 #20**  
No. of Coaxial Contacts **4**

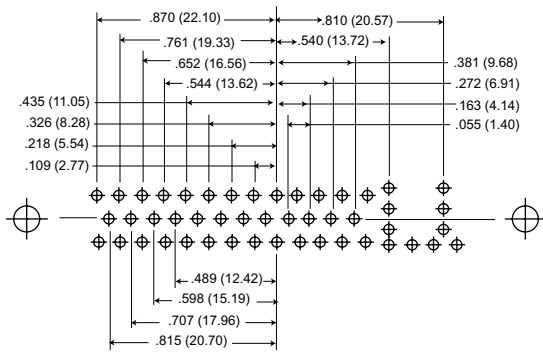

Shell Size **D**  
Contact Arrangement **43W2**  
No. of Signal Contacts **41 #20**  
No. of Coaxial Contacts **2**

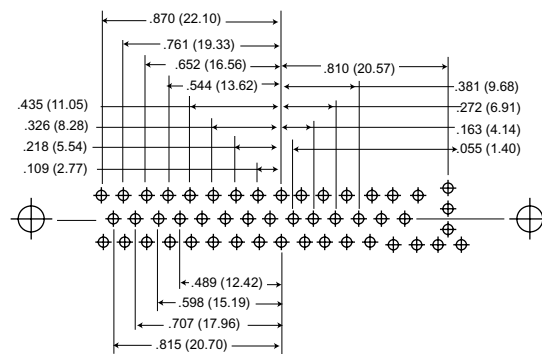

Shell Size **D**  
Contact Arrangement **47W1**  
No. of Signal Contacts **46 #20**  
No. of Coaxial Contacts **1**



# Combo D® - High Voltage

## Coaxial Housings With Solder Cup Signal Contacts

High voltage contacts supplied separately.



Contact Arrangements: Page 346 of Coax section  
Performance Specifications: Page 345 of Coax section.

Clinch Nut and Float Mount Options Available:

Add: E = 4-40 Clinch Nut  
Y = Float Mounting

Example: DAMME3W3P  
DAMMY3W3P

See page 334 for Mounting Method Detail.

Cable Combinations supplied with preloaded solder signal contacts. High Power Contacts supplied separately, see below.

Extraction Tool for High Power Contacts are the same as for 50 Ohm Coaxial Contacts. See page 348.

Layout	Military Socket	Military Pin	NM - Non-Magnetic Socket	NM - Non-Magnetic Pin
DE-5W1	DEM5W1S	DEM5W1P	DEM5W1S-NMB-K52	DEM5W1P-NMB-K52
DA-7W2	DAMM7W2S	DAMM7W2P	DAM7W2S-NMB-K52	DAM7W2P-NMB-K52
DA-11W1	DAMM11W1S	DAMM11W1P	DAM11W1S-NMB-K52	DAM11W1P-NMB-K52
DA-3W3	DAMM3W3S	DAMM3W3P	DAM3W3S-NMB-K47	DAM3W3P-NMB-K47
DB-5W5	DBMM5W5S	DBMM5W5P	DBM5W5S-NMB-K47	DBM5W5P-NMB-K47
DB-9W4	DBMM9W4S	DBMM9W4P	DBM9W4S-NMB-K52	DBM9W4P-NMB-K52
DB-13W3	DBMM13W3S	DBMM13W3P	DBM13W3S-NMB-K52	DBM13W3P-NMB-K52
DB-17W2	DBMM17W2S	DBMM17W2P	DBM17W2S-NMB-K52	DBM17W2P-NMB-K52
DB-21W1	DBMM21W1S	DBMM21W1P	DBM21W1S-NMB-K52	DBM21W1P-NMB-K52
DC-8W8	DCMM8W8S	DCMM8W8P	DCM8W8S-NMB-K47	DCM8W8P-NMB-K47
DC-13W6	DCMM13W6S	DCMM13W6P	DCM13W6S-NMB-K52	DCM13W6P-NMB-K52
DC-17W5	DCMM17W5S	DCMM17W5P	DCM17W5S-NMB-K52	DCM17W5P-NMB-K52
DC-21WA4	DCMM21WA4S	DCMM21WA4P	DCM21WA4S-NMB-K52	DCM21WA4P-NMB-K52
DC-25W3	DCMM25W3S	DCMM25W3P	DCM25W3S-NMB-K52	DCM25W3P-NMB-K52
DC-27W2	DCMM27W2S	DCMM27W2P	DCM27W2S-NMB-K52	DCM27W2P-NMB-K52
DD-24W7	DDMM24W7S	DDMM24W7P	DDM24W7S-NMB-K52	DDM24W7P-NMB-K52
DD-36W4	DDMM36W4S	DDMM36W4P	DDM36W4S-NMB-K52	DDM36W4P-NMB-K52
DD-43W2	DDMM43W2S	DDMM43W2P	DDM43W2S-NMB-K52	DDM43W2P-NMB-K52
DD-47W1	DDMM47W1S	DDMM47W1P	DDM47W1S-NMB-K52	DDM47W1P-NMB-K52

## High Power Contacts

Solder Type

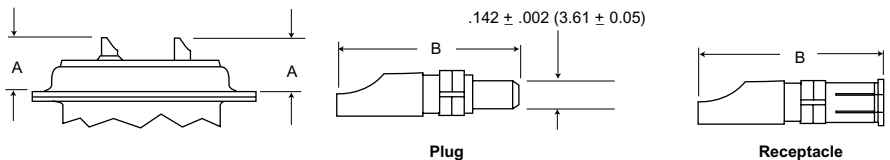

	Gold over Nickel	50µ in. Gold over Copper	NM - Non-Magnetic 50µ in. Gold over Copper	A Max.	B Ref.	Current Rating (Amps)	Wire Size
Plug	DM53745-1	DM53745-28	DM53745-70	.666 (16.92)	.866 (22.00)	40	#8
Plug	DM53745-7	DM53745-27	DM53745-77	.666 (16.92)	.866 (22.00)	20	#12
Plug	DM53745-8	DM53745-25	DM53745-70	.666 (16.92)	.866 (22.00)	10	#16
Receptacle	DM53744-1	DM53744-21	DM53744-62	.666 (16.92)	.856 (21.74)	40	#8
Receptacle	DM53744-6	DM53744-25	DM53744-64	.666 (16.92)	.856 (21.74)	20	#12
Receptacle	DM53744-7	DM53744-24	DM53744-63	.666 (16.92)	.856 (21.74)	10	#16

Crimp Type

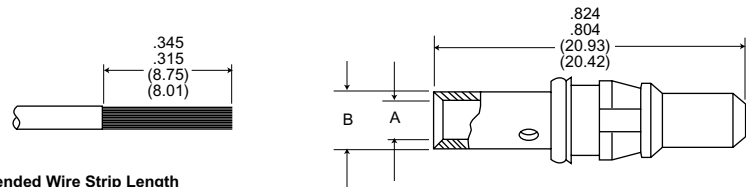

Recommended Wire Strip Length

	Gold over Nickel	50µ in. Gold over Copper	A Dia. Max.	B Dia. Max.	Current Rating (Amps)	Wire Size
Plug	DM130338-4	DM130338	.181 (4.60)	.230 (5.84)	40	#8
Plug	DM130339-4	DN130339	.100 (2.54)	.218 (5.54)	20	#12
Plug	DM130340-4	DM130340	.067 (1.07)	.102 (2.59)	10	#16
Receptacle	DM130341-4	DM130341	.181 (4.60)	.230 (5.84)	40	#8
Receptacle	DM130342-4	DM130342	.100 (2.54)	.218 (5.54)	20	#12
Receptacle	DM130343-4	DM130343	.067 (1.07)	.102 (2.59)	10	#16

Crimp Tooling - Page 357.

See Commercial D Subminiature catalog for PCB High Power connectors.

# Combo D® - High Power

## Crimp High Power Contact Tooling

(For use with Crimp High Power Contacts on Page 356)

AWG Wire Size	Daniels Crimp Tool	Crimp Tool/Locator	
		Tool Setting Number	Locator
8-10	M300-BT	AWG 8 = 6 AWG 10 = 5	TP968
12-14	M300-BT	AWG 12/14 = 1	TP968
16-18	FT-8	AWG 16 = 6 AWG 18 = 5	TH554

NOTE: Purchase tooling directly from Daniels.

## Combo D Guide Pin and Socket

Installs into any Combo D, size 8 Cavity. This patented guide pin and socket system is ideal for blind mate applications where space is limited.

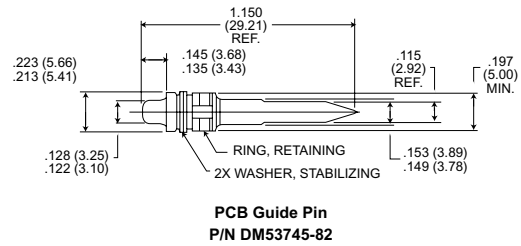
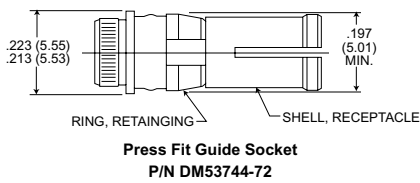

Description	Material	Finish
Guide Pin	Brass	Gold over nickel
Guide Socket	Copper Alloy	Gold over nickel

# Combo D® - High Voltage

## Coaxial Housings With Solder Cup Signal Contacts

High voltage contacts supplied separately.



Contact Arrangements: Page 346 of Coax section  
Performance Specifications: Page 345 of Coax section.

Clinch Nut and Float Mount Options Available:

Add: E = 4-40 Clinch Nut  
Y = Float Mounting

Example: DAMME3W3P  
DAMMY3W3P

Mouting Method Detail - Page 334.

Cable Combinations supplied with preloaded solder signal contacts. High Voltage Contacts supplied separately, see below.

Extraction Tool for High Voltage Contacts are the same as for 50 Ohm Coaxial Contacts. See page 348.

Layout	Military Socket	Military Pin
DE-5W1	DEMM5W1S	DEMM5W1P
DA-7W2	DAMM7W2S	DAMM7W2P
DA-11W1	DAMM11W1S	DAMM11W1P
DA-3W3	DAMM3W3S	DAMM3W3P
DB-5W5	DBMM5W5S	DBMM5W5P
DB-9W4	DBMM9W4S	DBMM9W4P
DB-13W3	DBMM13W3S	DBMM13W3P
DB-17W2	DBMM17W2S	DBMM17W2P
DB-21W1	DBMM21W1S	DBMM21W1P
DC-8W8	DCMM8W8S	DCMM8W8P
DC-13W6	DCMM13W6S	DCMM13W6P
DC-17W5	DCMM17W5S	DCMM17W5P
DC-21WA4	DCMM21WA4S	DCMM21WA4P
DC-25W3	DCMM25W3S	DCMM25W3P
DC-27W2	DCMM27W2S	DCMM27W2P
DD-24W7	DCMM24W7S	DCMM24W7P
DD-36W4	DCMM36W4S	DCMM36W4P
DD-43W2	DCMM43W2S	DCMM43W2P
DD-47W1	DCMM47W1S	DCMM47W1P

## High Voltage Combination Contacts

Wire Accommodation (AWG)	#20 Max.
Current Rating	5 Amp
Temperature Rating	-55°C to +125°C

Description	Material	Finish
Contacts	Copper Alloy	Std: Gold over nickel MIL-50μ in. Gold over copper
Insulator	Thermoplastic	None
Ring, Retaining	Copper Alloy	Nickel

### Straight

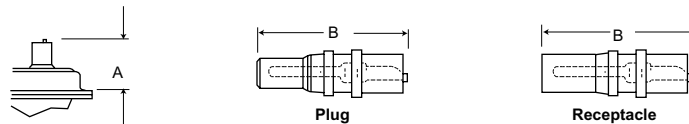

	Gold over Nickel	50μ in. Gold	A Max.	B Ref.	Wire Size
Plug	DM51157	DM51157-8	.539 (13.69)	.734 (18.64)	#20
Receptacle	DM51155	DM51155-7	.539 (13.69)	.764 (19.41)	#20

### Right Angle

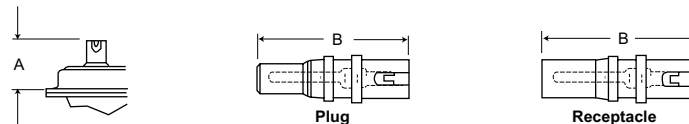

	Gold over Nickel	50μ in. Gold	A Max.	B Ref.	Wire Size
Plug	DM51157-5000	DM51157-5005	.491 (12.47)	.697 (17.70)	#20
Receptacle	DM51155-5000	DM51155-5004	.491 (12.47)	.697 (17.70)	#20

### Straight PCB

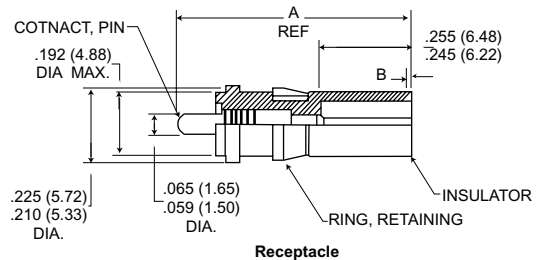
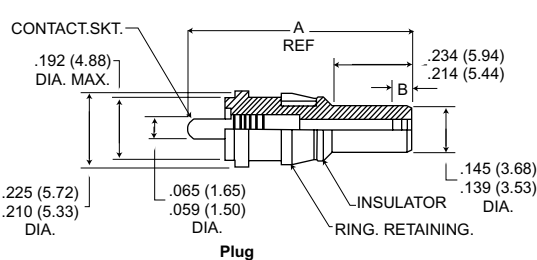

	Standard Finish	Military Finish	A	B
Plug	DM51157-13	DM51157-14	.628 (15.95)	.060/.050 (1.52/1.27)
Receptacle	DM51155-12	DM51155-13	.660 (16.76)	.010/.000 (0.25/0.00)



The Cannon D\*D Environmental Series is designed to meet the demand for sealed subminiature rectangular plugs with superior vibration and moisture resistance characteristics for aircraft, missile, and ground support equipment applications.

Featuring a rugged aluminum shell and peripheral seal, the D\*D connector meets all applicable requirements of MIL-C-24308. Available in both sol-

der and crimp versions, all assemblies are provided with nylon potting cups and dust caps.

Solder type contacts are non-removable and are factory-installed. Crimp type connectors utilize the field-proven LITTLE CAESAR® rear insertion, rear-release retention system.

**PLEASE NOTE: The D\*D Series is not interchangeable with other D Subminiature connectors.**

## Performance and Material Specifications

Shell	Aluminum, cadmium plated with yellow chromate supplementary coating.
Contacts	Solder pot: Copper alloy, gold plated .00002 (0.0005) over nickel .00004 (0.0010). Crimp type: Copper alloy, gold plated .00002 (0.0005) over nickel .00004 (0.0010)
Insulator	Diallyl phthalate, per MIL-M-14, Type MDG or SDG-F
Contact Termination	Solder pot accommodating up to #20 AWG stranded wire. Crimp type accommodating #20, #22 and #24 AWG stranded wire.
Socket Type	Closed entry
Float Mounting Rivets & Washers	Stainless steel Passivated per QQ-P-35

## Test Data

Specifications	
Voltage Rating	All voltage figures are AC (rms). 60 Hz measured at approximately 25.0°C 50% RH
Insulation Resistance (per MIL-C-24308)	Greater than 5,000 megohms, determined in accordance with MIL-STD-202A, Method 302.
Contact Voltage Drop	2.67 millivolts, maximum, per amp.
Contact Separation Force	1 to 8 ounces when tested in accordance with MIL-C-24308.
Air Leakage	When properly wired and potted, 1 cubic inch of air per hour max. when subjected to 30 PSI pressure differential in accordance with MIL-C-5015D, Paragraph 4.5.3.1
Vibration (per MIL-C-24308)	Exceeds test requirements of MIL-STD-202A, Method 204, Condition D.
Corrosion Resistance (per MIL-C-24308)	Exceeds requirements of 50 hour exposure to salt spray in accordance with MIL-STD-202A, Method 101A, Condition B.
Moisture Resistance (per MIL-C-24308)	Exceeds requirements of MIL-STD-202A, Method 106.
Shock	Exceeds requirements of MIL-STD-202A, Method 213, Condition G
Environmental Seal	Effective from full engagement to 1/16 short of full engagement.
Contact Retention Force	(Crimp type) 8 pounds (35.6 newtons) minimum of first cycles: 5 pounds (22.2 newtons) minimum after tenth cycle.
Standard Layout Plugs	Measured from contact-to-contact, and contact-to-shell or unmated condition.

	ALTITUDE (FEET)			
	Sea Level	20,000	50,000	70,000
Average Flash-over	1700	1000	650	500
Test	1250	750	475	375

See *Commercial D Subminiature* catalog for additional Combo D options, including 75 ohm Coax.

## How to Order

### Solder Cup Terminals

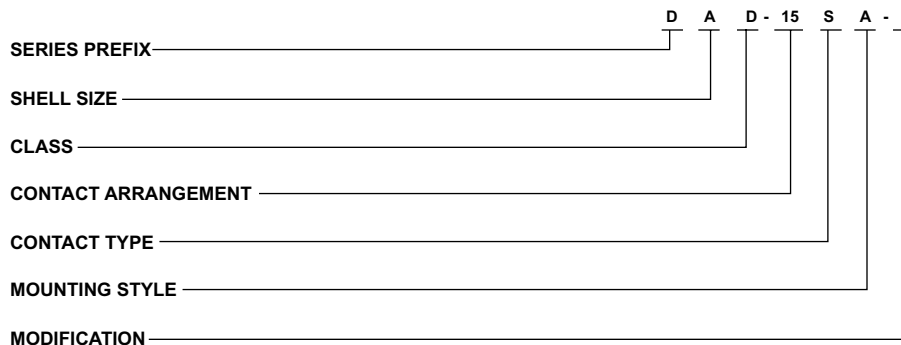

**SERIES PREFIX**

ITT Cannon Designation

**SHELL SIZE**

A, B, C, D, E

**CLASS**

D - Environmental

**CONTACT ARRANGEMENT**

9, 15, 25, 37, 50

**CONTACT TYPE**

P - Pin  
S - Socket

**MOUNTING STYLE**

A - Standard mounting holes  
B - Float mounts supplied

**MODIFICATION**

Consult factory

### Snap-In Crimp Terminals

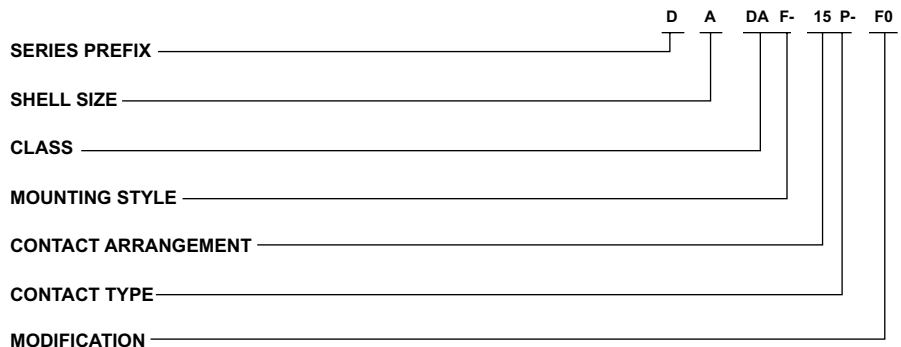

**SERIES PREFIX**

ITT Cannon Designation

**SHELL SIZE**

A, B, C, D, E

**CLASS**

DA - Environmental, crimp type

**MOUNTING STYLE**

No Designator - Standard mounting  
F - Float mounts supplied

**CONTACT ARRANGEMENT**

9, 15, 25, 37, 50

**CONTACT TYPE**

P - Pin  
S - Socket

**MODIFICATION**

F0 - Connector supplied less contacts, for other modifications consult factory.

## Contact Arrangements

### Faces View Pin Insert

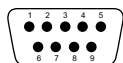

**E**  
9  
#20

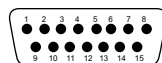

**A**  
15  
#20

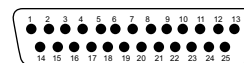

**B**  
25  
#20

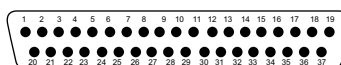

**C**  
37  
#20

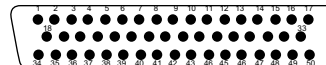

**D**  
50  
#20

Shell Size  
Contact Arrangement  
Contact Size

Shell Size  
Contact Arrangement  
Contact Size

## Shell Dimensions, Standard Mount

### Receptacle

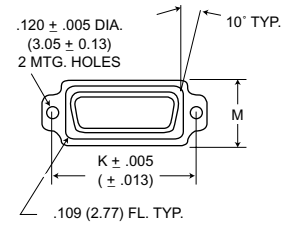
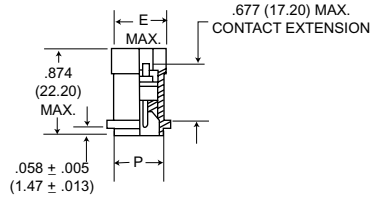
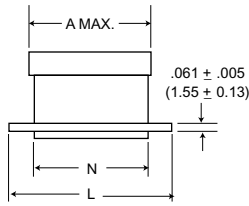

### Plug

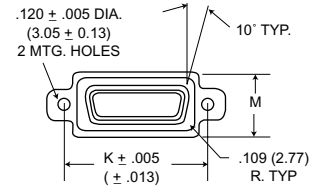
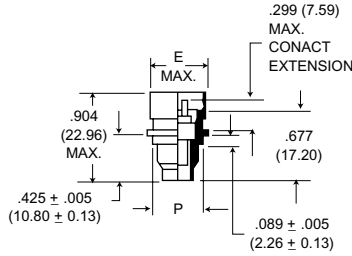
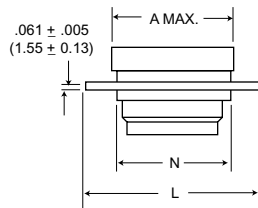

## Float Mount Dimensions

### Receptacle

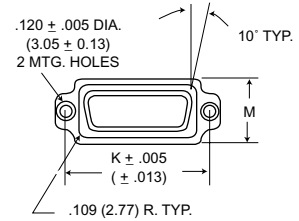
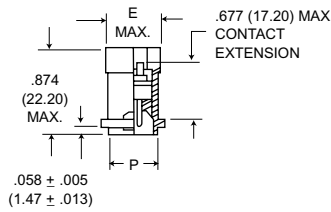
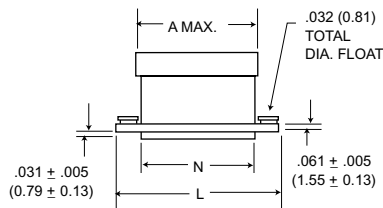

### Plug

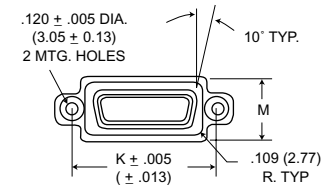
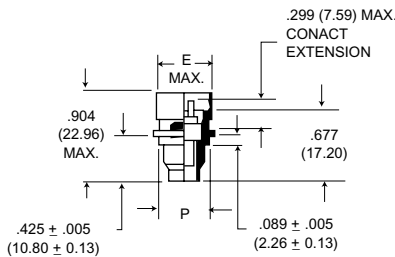
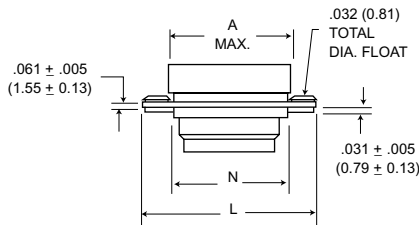

NOTE: All D\*D Environmental plugs and receptacles are provided with dust caps and removable potting cups.

Shell Size	A Max.	E Max.	K ± .005 (0.13)	L ± .010 (0.25)	M ± .010 (0.25)	N ± .010 (0.25)	P ± .010 (0.25)
DED-9P	.915 (23.24)	.596 (15.14)	1.125 (28.58)	1.442 (36.63)	.614 (15.60)	.825 (20.86)	.483 (12.27)
DED-9S	.915 (23.24)	.596 (15.14)	1.125 (28.58)	1.442 (36.63)	.614 (15.60)	.825 (20.86)	.483 (12.27)
DAD-15P	1.233 (31.32)	.596 (15.14)	1.437 (36.50)	1.755 (44.58)	.614 (15.60)	1.143 (29.03)	.483 (12.27)
DAD-15S	1.233 (31.32)	.596 (15.14)	1.437 (36.50)	1.755 (44.58)	.614 (15.60)	1.143 (29.03)	.483 (12.27)
DBD-25P	1.786 (45.36)	.596 (15.14)	1.993 (50.62)	2.295 (58.29)	.614 (15.60)	1.683 (42.75)	.483 (12.27)
DBD-25S	1.786 (45.36)	.596 (15.14)	1.993 (50.62)	2.295 (58.29)	.614 (15.60)	1.683 (42.75)	.483 (12.27)
DCD-37P	2.458 (62.43)	.567 (14.40)	2.625 (66.68)	2.937 (74.60)	.614 (15.60)	2.343 (59.51)	.483 (12.27)
DCD-37S	2.458 (62.43)	.567 (14.40)	2.625 (66.68)	2.937 (74.60)	.614 (15.60)	2.343 (59.51)	.483 (12.27)
DDD-50P	2.390 (60.71)	.680 (17.27)	2.531 (64.29)	2.859 (72.62)	.735 (18.67)	2.251 (57.18)	.596 (15.14)
DDD-50S	2.390 (60.71)	.680 (17.27)	2.531 (64.29)	2.859 (72.62)	.735 (18.67)	2.251 (57.18)	.596 (15.14)

All tolerances are ± .010 (0.24) unless noted otherwise.

Mounting Dimensions

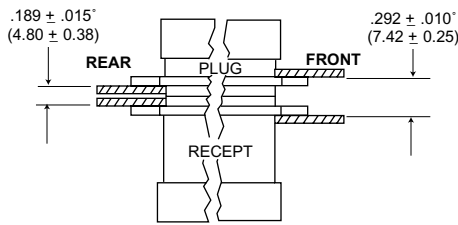

Figure 1

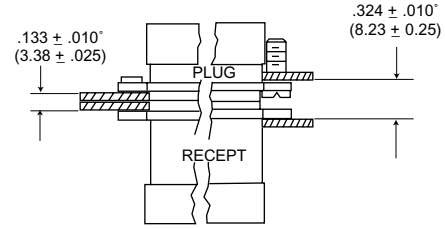

Figure 3

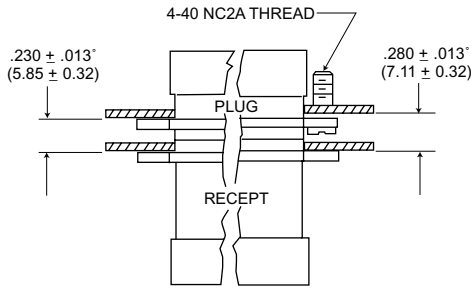

Figure 5

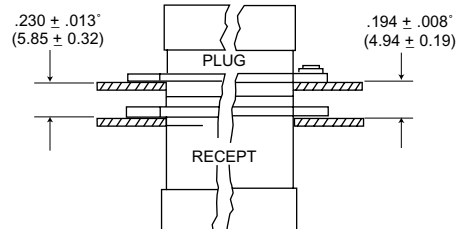

Figure 7

NOTE: Max panel thickness is .125 (3.17) for non-floating rear panel mounting.

1. With both connectors rear mounted, use #4-40 flat head screws flush with the panel (Fig. 1).
2. With both connectors front mounted, use #4-40 binder or pan head screws (Fig. 2).
3. With both connectors rear mounted (float rivets on plug assembly side); use #4-40 flat head screws, flush with the panel (Fig. 3).
4. With both connectors front mounted (plug assembly has float mounting screw), use #4-40 binder or pan head screws for receptacle assembly (Fig. 4).

5. With plug assembly front mounted and receptacle assembly rear mounted, use hardware from Figures 5 and 6.
6. With plug assembly front mounted and receptacle assembly rear mounted (plug assembly has float mounting screw), use hardware from figure 1 for receptacle assembly.  
\* Dimensions between panels represent the recommended limit to be used in the design of the connector mounting method.
7. With plug assembly rear mounted and receptacle assembly front mounted, use hardware from Figures 1 and 2.

8. With plug assembly rear mounted (float rivets) and receptacle assembly front mounted, use hardware from Figures 2 and 3.
9. Electrical contact engagement when mounted per Figure 1 is .046 (1.17) min./0.070(1.78) max.

NOTE: Float rivets are for rear mounting only and float screw for front mounting only. (Specify when ordering.)

Panel Cutouts

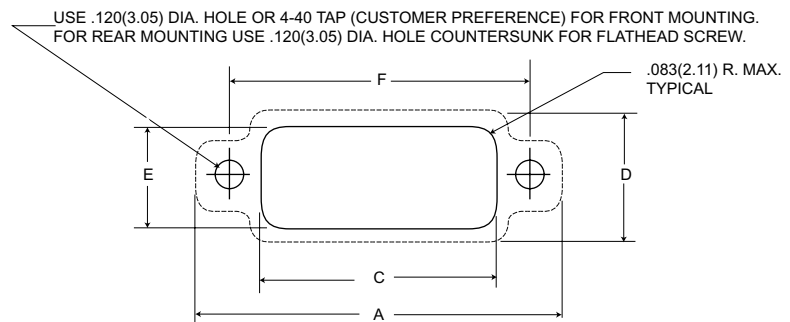

Shell Size	A + .010 (0.25)	C Min.	D ± .010 (0.25)	E Min.	F + .006 (0.15)
DED-9	1.442 (36.63)	.839 (21.31)	.614 (15.60)	.497 (12.62)	1.125 (28.58)
DAD-15	1.755 (44.58)	1.157 (29.39)	.614 (15.60)	.497 (12.62)	1.437 (36.50)
DBD-25	2.295 (58.29)	1.697 (43.10)	.614 (15.60)	.497 (12.62)	1.993 (50.62)
DCD-37	2.937 (74.60)	2.357 (59.87)	.614 (15.60)	.497 (12.62)	2.625 (66.68)
DDD-50	2.859 (72.62)	2.265 (57.53)	.735 (18.67)	.610 (15.49)	2.531 (64.29)

Add .032 (0.81) to dimensions C and E for float mounting.  
Note: Panel cutout does not allow for potting cup clearance.

## Contact Crimping Information

### Crimp Type Contacts

Contact Size	Wire Size Accom.	Standard Finish		Military Finish	
		Pin	Socket	Pin	Socket
20	20, 22, 24	330-5291-015	031-1007-000	330-5291-079	031-1007-042

### Semi-Automatic Crimp Machines

### Insertion/Extraction Tools

CIET-20HD

Contact Size	AWG	Plastic Insertion/Extraction		Plastic Extraction	
		Part No.	Description	Part No.	Description
20	20, 22, 24	980-2000-426	CIET-20HD	323-7010-000	CET-20-11

### CBT-646

The CBT-646, Vibra-Bowl Crimper is a pneumatically powered, electronically controlled machine. It is designed to semi-automatically crimp closed barrel, machined contacts, as used in the aerospace and commercial industries. The machine will accommodate wire sizes 30 thru 12 AWG. The CBT-646 is actuated automatically upon insertion of a pre-stripped stranded or single conductor wire. The CBT-646 meets all Mil. Spec. requirements for crimping closed barrel contacts.



### Hand Crimp Tools

M22520/1-01

M22520/2-01

Contact Size	AWG	Crimp Tool		Locator	
		Part No.	Description	Part No.	Description
20	20, 22, 24	995-0001-584	M22520/2-01	995-0001-604	M22520/2-08
		995-0001-585	M22520/1-01	995-0001-244	TH25

**Machine Crimp Range:** 1300 + per hour

### Power Requirements:

Electrical = 115 Vac, 60 Hz, 5A

Pneumatic = 85 psi, 2 cu. ft. per min.

**Products:** Most ITT Cannon Commercial and Aerospace closed-barrel contacts, wire sizes 30 thru 12 AWG. See connector line for part numbers.

## Assembly Instructions

### Wire Stripping-Machined Contacts

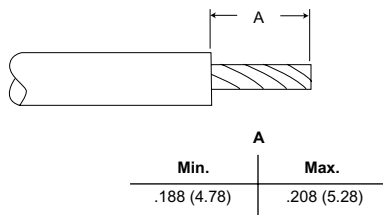

### Contact Crimping



### Contact Insertion



1. Cut wires to length. Strip insulation per above illustration. Check for broken or frayed wires.

2. Insert contact and wires into proper crimp tool (and locator, if required). Crimp contact to wires. Inspect crimp.

3. Center wired contact in groove of insertion tool with tool tip butting contact shoulder. Insert contact into cavity until a positive stop is felt. Inspect insertion.



### Contact Extraction



4. To be sure contact is locked securely, pull back lightly on wire. Repeat for balance of contacts working row by row across the insulator.

5. Place wire into extraction tool tip.

6. Insert tool tip into contact cavity until tip bottoms against contact shoulder, releasing tines. Hold wires against tool with finger and remove tool and contact. Repeat for balance of contacts.





- Environmental Protection
- MIL-C-24308 Compatibility
- Reliability and Versatility

GD\* connectors are ideal for aerospace, military, telecommunications and other applications requiring environmental protection and high reliability.

ITT Cannon developed GD\* connectors to meet the needs of the avionics industry. These connectors provide high-density and moisture protection.

Environmental protection is accomplished by the resilient grommet, interfacial seal, and bonded connector components.

## Performance and Material Specifications

### MATERIALS AND FINISHES

	Materials	Finishes
Shell	Low carbon steel per ASTM-A-620	Yellow chromate over cadmium per QQ-P-416, Type II, Class 2
Insulator	Diallyl phthalate per MIL-M-14 type SDF-F or GDI-30F	-
Contacts	Copper alloy	Standard finish: Gold over nickel Military Finish: Gold 50 microinches thickness per MIL-G-45204, Type II, Grade C, Class 1, over copper per MIL-C-14550
Float Mount Hardware	Stainless steel	Passivated per QQ-P-35
Grommets and Seals	Silicone elastomer or Fluorosilicone	
Bonding Materials	Epoxy	-

### MECHANICAL FEATURES

Wire Accommodation - Contact: #20, #22, #24 AWG.

Wire O.D. .071 (1.80) maximum, .038 (0.97) minimum.

Contact Retention - 9 lbs. minimum (40n) after 10 insertions.

### ELECTRICAL DATA

Test Voltage AC RMS 60 Hz

	Sea Level	20,000 Ft.	50,000 Ft.	70,000 Ft.
Average Flashover	1,000	1,000	500	500
Test	1,000	650	325	325

Maximum Current Carrying Capacity of Contacts - #20 Contacts: 5 Amps

Temperature Range - -65°C to +150°C (-53.9°F to +302°F)

## How to Order

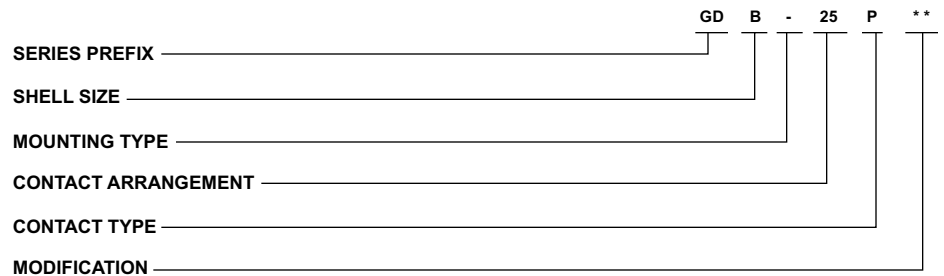

**SERIES PREFIX**  
GD - Grommet D

**SHELL SIZE**  
E, A, B, D

**MOUNTING TYPE**  
No Designator - .120 (3.05) Diameter Mounting Holes  
Y - Float Mount for Rear and Front Panel Mounting

**CONTACT ARRANGEMENT**  
9, 15, 25, and 50

**CONTACT TYPE**  
P - Pin, crimp termination  
S - Socket, crimp termination  
PB - Pin, Printed circuit termination with non-removable straight tails for .125 (3.18) maximum P.C. Board thickness

**MODIFICATIONS (Typical Modifiers)**  
F0 - Connectors supplied Less Contacts  
A156 - Connectors supplied with contacts plated per MIL-G-45204 Type II Class 1 over copper per MIL-C-14550 (M24308 Finish)

**Test Data**

GD\* connectors meet all applicable requirements of MIL-C-24308. The following are excerpts from ITT Cannon Test Report C82-78 applicable to environmental D subminiature GD\* series connectors. Refer to MIL-C-24308 Test Extracts on page 385.

Test Description	Test Method	Results
Moisture Resistant	MIL-STD-1344 Method 1002.1 Type II	1. No deterioration of performance. 2. Insulation resistance greater than 100 megohms 3. No evidence of flashover or breakdown during 1000 VAC DWV testing.
Fluid Immersion	20 hours immersion in hydraulic fluid per MIL-H-5606 and lubricating fluid per MIL-L-23699	1. No detrimental damage. 2. Able to meet requirements of mating and unmating forces test.
Immersion	Two hour Immersion tap water at a dept of 36.00 (914.40) in mated condition, per MIL-STD-810 Method 512, Procedure 1.	While still immersed, the mated connectors exceeded 100 megohm insulator resistance and exhibited no evidence of breakdown or flashover during 1000 VAC (RMS) DWV testing.

**Design Features**

- Resilient silicone grommets for wire sealing
- Interfacial seals
- Closed-entry socket contacts
- Bonded components to prevent moisture
- Optional sealing plugs
- Uses M39029 type contacts and termination tooling
- Intermateable with most M24308 type connectors
- Rear-release crimp contacts
- LITTLE CAESAR® contact retention assembly

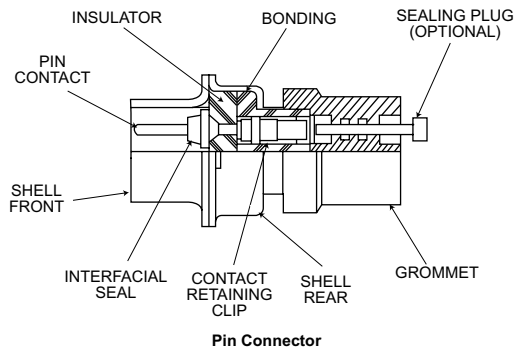
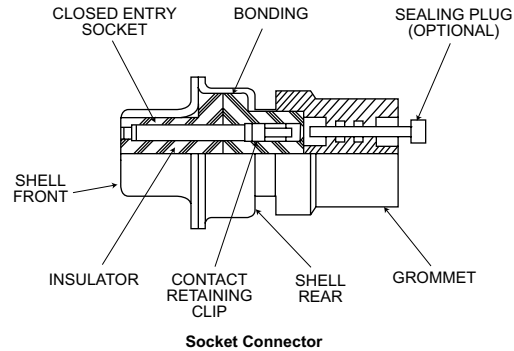

**Printed Circuit Applications**

GD\* pin connectors are available with pre-loaded, non-removable contacts for P.C. board termination. Typical Part No. GDB-25PB. Environmental sealing is accomplished by application of epoxy to each contact cavity, interfacial seals, and bonded connector components.

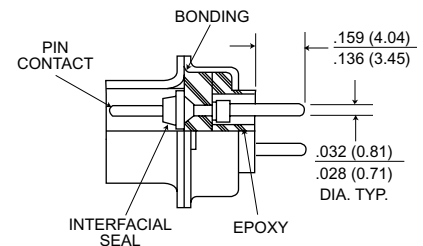

## Standard Shell Dimensions

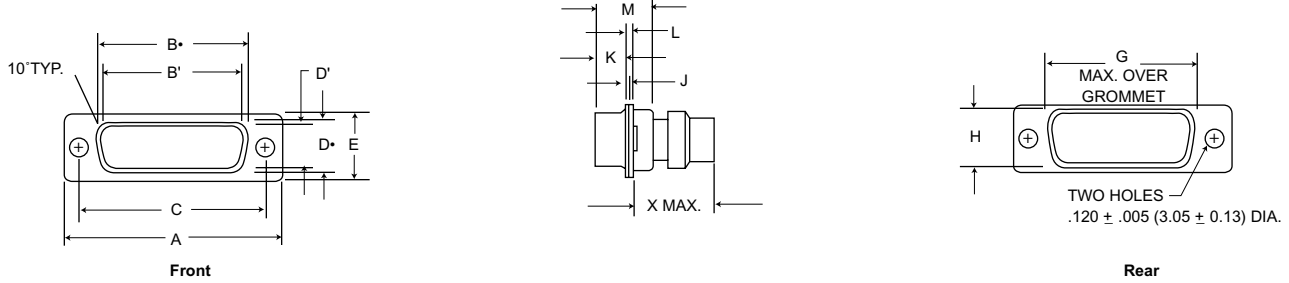

## Shell With Float Mount Dimensions

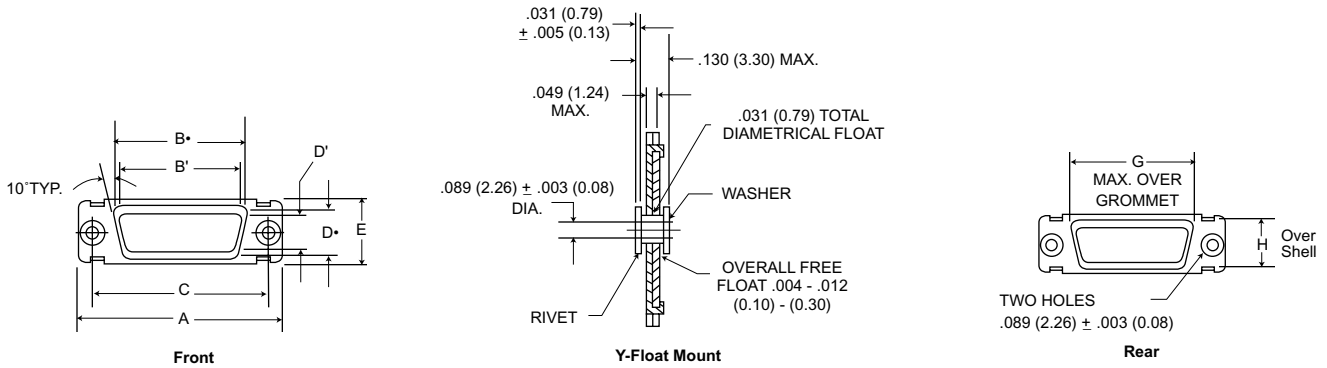

It is recommended that only one assembly, either pin or socket, be float mounted. For front panel mounting use reverse float mount.

Shell Size	A ± .015 (0.38)	B* ± .005 (0.13)	B' ± .005 (0.13)	C ± .005 (0.12)	D* ± .005 (0.13)	D' ± .005 (0.13)	E ± .015 (0.38)	G Max.	H ± .010 (0.25)	J ± .010 (0.25)	K ± .006 (0.13)	L ± .010 (0.25)	M ± .005 (0.13)	X Max.
GDE-9P	1.213 (30.81)	-	.666 (16.91)	.984 (24.99)	-	.329 (8.36)	.494 (12.55)	.750 (19.05)	.422 (10.72)	.030 (0.76)	.235 (5.97)	.045 (1.14)	.422 (10.72)	.718 (18.24)
GDE-9S	1.213 (30.81)	.643 (16.33)	-	.984 (24.99)	.311 (7.90)	-	.494 (12.55)	.750 (19.05)	.422 (10.72)	.030 (0.76)	.243 (6.17)	.045 (1.14)	.429 (10.90)	.718 (18.24)
DGA-15P	1.541 (39.14)	-	.994 (25.24)	1.312 (33.32)	-	.329 (8.36)	.494 (12.55)	1.093 (27.76)	.422 (10.72)	.030 (0.76)	.235 (5.97)	.045 (1.14)	.422 (10.72)	.718 (18.24)
GDA-15S	1.541 (39.14)	.971 (24.66)	-	1.312 (33.32)	.311 (7.90)	-	.494 (12.55)	1.093 (27.76)	.422 (10.72)	.030 (0.76)	.243 (6.17)	.045 (1.14)	.429 (10.90)	.718 (18.24)
GDB-25P	2.088 (53.03)	-	1.534 (38.96)	1.852 (47.04)	-	.329 (8.36)	.494 (12.55)	1.625 (41.28)	.422 (10.72)	.039 (0.99)	.230 (5.84)	.060 (1.52)	.426 (10.82)	.718 (18.24)
GDB-25S	2.088 (53.03)	1.511 (38.38)	-	1.852 (47.04)	.311 (7.90)	-	.494 (12.55)	1.625 (41.28)	.422 (10.72)	.030 (0.76)	.243 (6.17)	.045 (1.14)	.429 (10.90)	.718 (18.24)
GDD-50P	2.635 (66.92)	-	2.079 (52.81)	2.406 (61.11)	-	.441 (11.20)	.605 (15.37)	2.162 (54.91)	.534 (13.56)	.039 (0.99)	.230 (5.84)	.060 (1.52)	.426 (10.82)	.718 (18.24)
GDD-50S	2.635 (66.92)	2.064 (52.42)	-	2.406 (61.11)	.423 (10.74)	-	.605 (15.37)	2.162 (54.91)	.534 (13.56)	.030 (0.76)	.243 (6.17)	.045 (1.14)	.429 (10.90)	.718 (18.24)

\* dimensions B, D, and H are measured as outside dimensions at the bottom of draw.

NOTE: B\* and D\* are the outside dimensions for socket side, B' and D' are the inside dimensions for pin side.

## Contact Arrangements

Face View Pin Insert

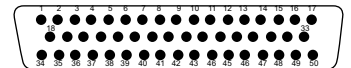
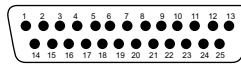
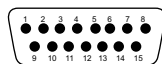
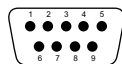

Shell Size  
Contact Arrangement  
Contact Size

E  
9  
#20

A  
15  
#20

B  
25  
#20

D  
50  
#20

---

**Contacts**

---

Finish	Type	ITT Cannon Part Number	M39029 Part Number
Standard	Pin #20	330-5291-000	
Gold/Nickel	Socket #20	031-1007-000	
A156	Pin #20	330-5291-037	M39029/64-369
Gold/Copper	Socket #20	031-1007-042	M39029/63-368

---

**Accessories**

---

**SEALING PLUGS:** GD\* grommets are designed to accept MS27488-20 sealing plugs, ITT Cannon P/N 225-0070-000 ordered separately.

**LOCKING HARDWARE, DUST CAPS:** GD\* Connectors will accommodate most standard D Subminiature accessories.

---

**Hand Crimp Tool**

---

M22520/2-01 with M22520/2-08 locator. Semi-automatic and fully automatic tooling is also available.

**Insertion/Extraction Tool (Plastic)**

---

Contact Size	ITT Cannon Description	ITT Cannon Part Number	Insertion Color Tip	Extraction Color Tip
#20	CIET-20HDL	274-7010-000	White	Green

---

# D Subminiature Accessories

ITT Cannon offers one of the broadest lines of accessories for the D Subminiature line of connectors in today's marketplace. The ITT Cannon accessory line offers unlimited design versatility. Choose from a variety of plastic, metal, EMI/RFI backshells, screwlocks, jackscrews, and spring latches.

## Backshell/Hardware Compatibility Chart

		Locking Hardware								
		Male Screw Locks 020419/ 020420	Female Screw-Locks D20418	Jack-screw D110550	Jack-post D110551	Slide Locks DA51220-1 thru DE51224-1	Slide Lock Post D53018	Spring Latch D110277/ D110279	Spring Latch Plate D110279/ D110280	Keying Plate
MOUNTING METHOD	Front Panel		•		•	•	•	•		•
	Rear Panel		•			•	•	•		
METAL BACKSHELLS	Deep Straight Clamp	•	•		•	•	•	•	•	•
	Right Angle		•			•	•	•	•	•
	Round Clamp	•	•		•	•	•	•	•	•
	Straight Clamp	•	•		•	•	•	•	•	•
SHIELDED BACKSHELLS	Plated Plastic									
	Die-Cast Zinc									
PLASTIC BACKSHELLS	Straight & 90° (D*5121X)					•	•	•	•	•
	Universal D*110963	•	•	•	•			•	•	
	Snap-Together Universal	•	•	•	•			•	•	
	Dataphone DB51226-1B	Supplied with male screw locks.								
	IDC D*115386 STR/90° D*115339	Designed for use with quick-disconnect latching hardware (see page 376).								
POTTING CUPS	Plastic	•	•		•	•	•	•	•	•

Legend: • = Compatible

# Accessories - M85049 Backshells

## Deep Straight Clamp

- Positive strain relief

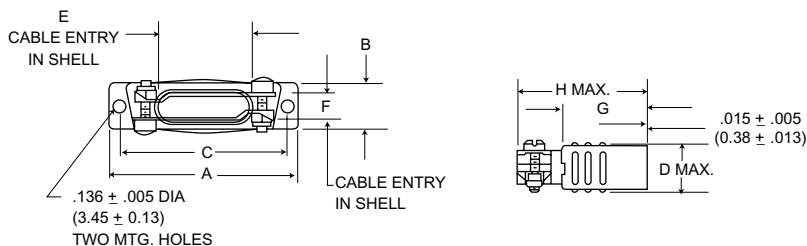

MIL-Spec.

Material: Low Carbon Steel per ASTM A-620  
Finish: Yellow Chromate Over Cadmium per M85049 Specification

Non-Magnetic/No-Outgas\*

Material: Brass per QQ-B-613  
Finish: Gold over copper per MIL-G-45204, Type II, Grade C,  
Class 1 or Electroless nickel per MIL-C-26074B

(Superseded MIL-Spec. No.: M24308/20-1 thru-5)

Layout	Part Number	Mil. Spec.	Plating		A	B	C	D Max.	E	F	G	H Max.
			AU	NI	± .015 (0.38)	± .015 (0.38)	± .005 (0.13)		± .015 (0.38)	± .015 (0.38)	± .015 (0.38)	
DE-9	DE24657	M85049/48-1-1	DE24657	-16 -27	1.203 (30.6)	.484 (12.3)	.984 (25.0)	.578 (14.7)	.375 (9.5)	.375 (9.5)	7.50 (19.0)	1.250 (31.7)
DA-15	DA24658	M85049/48-1-2	DA24658	-15 -25	1.531 (38.9)	.484 (12.3)	1.312 (33.3)	.578 (14.7)	.713 (18.1)	.312 (7.9)	7.50 (19.0)	1.250 (31.7)
DB-25	DB24659	M85049/48-1-3	DB24659	-15 -25	2.078 (52.8)	.484 (12.3)	1.852 (47.0)	.578 (14.7)	1.000 (25.4)	.312 (7.9)	1.000 (25.4)	1.563 (39.7)
DC-37	DC24660	M85049/48-1-4	DC24660	-16 -25	2.718 (69.0)	.484 (12.3)	2.500 (63.5)	.578 (14.7)	1.375 (34.9)	.312 (7.9)	1.000 (25.4)	1.563 (39.7)
DD-50	DD24661	M85049/48-1-5	DD24661	-13 -23	2.625 (66.7)	.593 (15.1)	2.406 (61.1)	.687 (17.4)	1.406 (35.7)	.406 (10.3)	1.125 (28.6)	1.688 (42.9)

\* Meet requirements of M85049

## Round Clamp

- Low profile
- Round cable applications

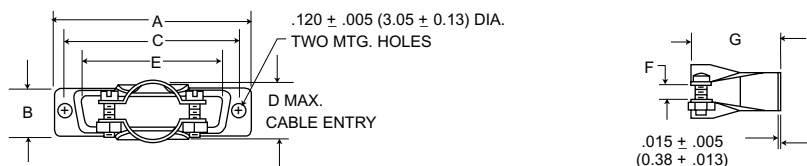

MIL-Spec.

Material: Low Carbon Steel per ASTM A-620  
Finish: Yellow Chromate Over Cadmium per M85049 Specification

Non-Magnetic/No-Outgas\*

Material: Brass per QQ-B-613  
Finish: Gold over copper per MIL-G-45204, Type II, Grade C,  
Class 1 or Electroless nickel per MIL-C-26074B

(Superseded MIL-Spec. No.: M24308/21-1 thru-5)

Layout	Part Number	Mil. Spec.	Plating		A	B	C	D Max.	E	F	G
			AU	NI	± .015 (0.38)	± .015 (0.38)	± .005 (0.13)		± .015 (0.38)	± .015 (0.38)	± .030 (0.76)
DE-9	DE44994	M85049/48-2-1	DE44994	-2 -13	1.208 (30.7)	.500 (12.7)	.984 (25.0)	.406 (10.3)	.661 (16.8)	.125 (3.2)	1.031 (26.2)
DA-15	DA20961	M85049/48-2-2	DA20961	-16 -23	1.531 (38.9)	.500 (12.7)	1.312 (33.3)	.406 (10.3)	.984 (25.0)	.125 (3.2)	1.031 (26.2)
DB-25	DB20962	M85049/48-2-3	DB20962	-18 -27	2.078 (52.8)	.500 (12.7)	1.852 (47.00)	.593 (15.1)	1.515 (38.5)	.187 (4.7)	1.062 (27.0)
DC-37	DC20963	M85049/48-2-4	DC20963	-17 -26	2.718 (69.0)	.500 (12.7)	2.500 (63.5)	.718 (18.2)	2.171 (55.1)	.250 (6.3)	1.062 (27.0)
DD-50	DD20964	M85049/48-2-5	DD20964	-19 -31	2.625 (66.7)	.609 (15.5)	2.406 (61.1)	.812 (20.6)	2.093 (53.2)	.312 (7.9)	1.062 (27.0)

\* Meet requirements of M85049

# Accessories - M85049 Backshells

## Straight Clamp

- Low profile
- Discrete wire application

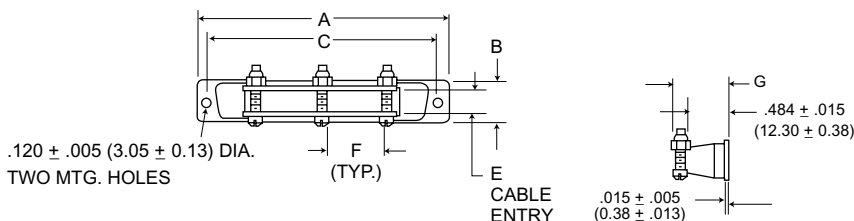

MIL-Spec.

Material: Low Carbon Steel per ASTM A-620

Finish: Yellow Chromate Over Cadmium per M85049 Specification

Non-Magnetic/No-Outgas\*

Material: Brass per QQ-B-613

Finish: Gold over copper per MIL-G-45204, Type II, Grade C,  
Class 1 or Electroless nickel per MIL-C-26074B

(Superseded MIL-Spec. No.: M24308/22-1 thru-4)

Layout	Part Number	Mil. Spec.	NM Non-Magnetic/ No-Outgas*		No. of Cable Locking Screws Req'd.	A ± .015 (0.38)	B ± .015 (0.38)	C ± .005 (0.13)	E ± .015 (0.38)	F ± .015 (0.38)	G ± .035 (0.89)
			Plating AU	NI							
DA-15	DA19678-1	M85049/48-3-2	DA19678	-167 -208	2	1.531 (38.9)	.500 (12.7)	1.312 (33.3)	.296 (7.5)	.312 (7.9)	.644 (16.36)
DB-25	DB19678-2	M85049/48-3-3	DB19678	-168 -209	2	2.078 (52.8)	.500 (12.7)	1.852 (47.0)	.296 (7.5)	.796 (20.2)	.644 (16.36)
DC-37	DC19678-3	M85049/48-3-4	DC19678	-138 -210	2	2.718 (69.0)	.500 (12.7)	2.500 (63.5)	.296 (7.5)	.687 (17.4)	.644 (16.36)
DD-50	DD19678-4	M85049/48-3-5	DD19678	-161 -211	3	2.625 (66.7)	.609 (15.5)	2.406 (61.1)	.390 (9.9)	.687 (17.4)	.694 (17.63)

## Right Angle

- Low profile
- Spaceborne applications

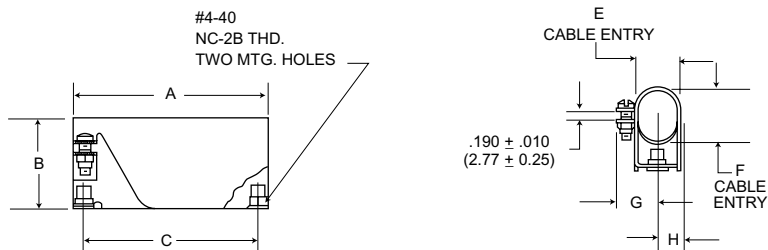

MIL-Spec.

Material: Low Carbon Steel per ASTM A-620

Finish: Yellow Chromate Over Cadmium per M85049 Specification

Non-Magnetic/No-Outgas\*

Material: Brass per QQ-B-613

Finish: Gold over copper per MIL-G-45204, Type II, Grade C,  
Class 1 or Electroless nickel per MIL-C-26074B

Layout	Part Number	Mil. Spec.	NM Non-Magnetic/ No-Outgas*		A ± .015 (0.38)	B ± .030 (0.76)	C ± .005 (0.13)	E ± .030 (0.76)	F ± .030 (0.76)	G ± .030 (0.76)	H ± .030 (0.76)
			Plating AU	NI							
DE-9	DE19977-5	M85049/50-1	DE19977	-47 -63	1.203 (30.6)	.718 (18.2)	.984 (25.0)	.437 (11.1)	.437 (11.1)	.468 (11.9)	.281 (7.1)
DA-15	DA19977-1	M85049/50-2	DE19977	-40 -64	1.531 (38.9)	.718 (18.2)	1.312 (33.3)	.437 (11.1)	.437 (11.1)	.468 (11.9)	.281 (7.1)
DB-25	DB19977-2	M85049/50-3	DE19977	-43 -52	2.078 (52.8)	.968 (24.6)	1.852 (47.0)	.437 (11.1)	.625 (15.9)	.468 (11.9)	.281 (7.1)
DC-37	DC19977-3	M85049/50-4	DE19977	-45 -65	2.718 (69.0)	1.187 (30.10)	2.500 (63.5)	.437 (11.1)	.812 (20.6)	.468 (11.9)	.281 (7.1)
DD-50	DD19977-4	M85049/50-5	DE19977	-44 -66	2.625 (66.7)	1.250 (31.7)	2.406 (61.1)	.562 (14.3)	.906 (23.1)	.531 (13.5)	.343 (8.7)

\* Meet requirements of M85049

# Accessories - Shielded Metalized Plastic Backshells

## Snap-Together

- Quick and simple assembly using snap-together design feature
- No complicated crimp ferrule tooling needed
- Helps to comply with FCC shielding requirements

Material:	ABS Polymer
Finish:	Nickel over Copper
Temperature Range:	20/80°C
Attenuation:	44 DB @ 1000 MHZ

Design includes integral strain relieving cable clamp.

Backshell requires hardware - see page 372.

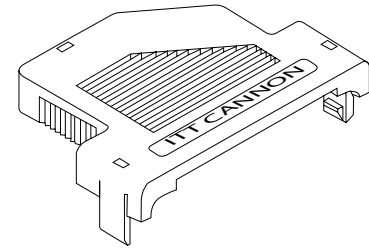
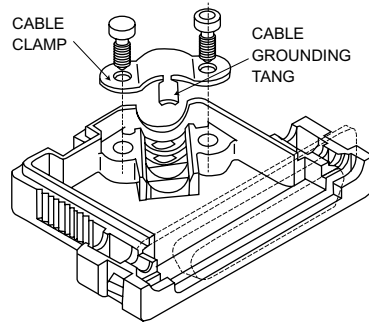

## Straight Exit

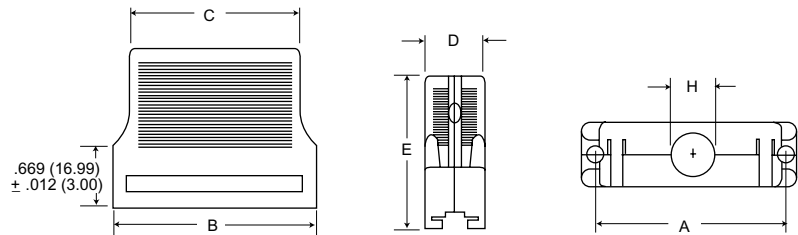

Layout	Part Number	A ± .006 (0.15)	B ± .012 (0.30)	C ± .012 (0.30)	C ± .012 (0.30)	E ± .008 (0.20)	H Max.
DE-9	DE121073-154	.982 (24.95)	1.213 (30.8)	.933 (23.7)	.630 (16.0)	1.417 (36.0)	.288 (7.32)
DA-15	DA121073-150	1.311 (33.30)	1.539 (39.1)	1.252 (31.8)	.630 (16.0)	1.654 (42.0)	.327 (8.31)
DB-25	DB121073-151	1.850 (47.00)	2.087 (53.0)	1.772 (45.0)	.630 (16.0)	1.654 (42.0)	.414 (10.52)
DC-37	DC121073-152	2.498 (63.45)	2.728 (69.3)	2.374 (60.3)	.630 (16.0)	1.654 (42.0)	.485 (12.32)

## 40° Exit

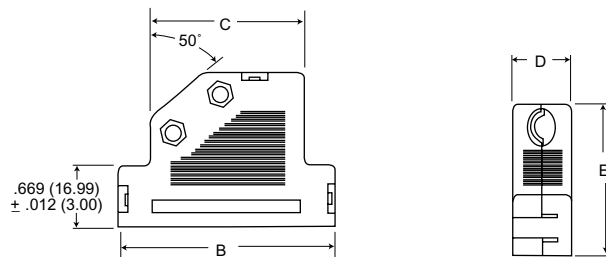

Layout	Part Number	B ± .012 (0.30)	C ± .012 (0.30)	D ± .012 (0.30)	E ± .008 (0.20)	Cable Diameter	
						Min.	Max.
DE-9	DE121073-54	1.417 (36.0)	.866 (22.0)	.630 (16.0)	1.417 (36.0)	.138 (3.5)	.295 (7.5)
DA-15	DA121073-50	1.744 (44.3)	1.075 (27.3)	.630 (16.0)	1.654 (42.0)	.256 (6.5)	.354 (9.0)
DB-25	DB121073-51	2.283 (58.0)	1.614 (41.0)	.630 (16.0)	1.654 (42.0)	.256 (6.5)	.433 (11.0)
DC-37	DC121073-52	2.933 (74.5)	2.264 (57.5)	.630 (16.0)	1.654 (42.0)	.256 (6.5)	.433 (11.0)
DD-50	DD121073-53	2.873 (73.0)	2.165 (55.0)	.748 (19.0)	1.654 (42.0)	.354 (9.0)	.512 (13.0)



# Accessories - Shielded Backshells

## #4-40 Locking Hardware For Snap-Together Shielded Backshells

Recessed Jackscrew

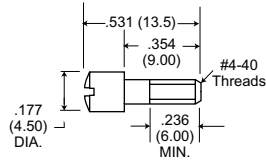
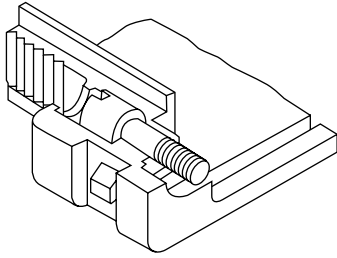

Part Number:	250-8501-004
Material:	Brass
Finish:	Nickel
Quantity Required per Backshell:	2

Extended Jackscrew

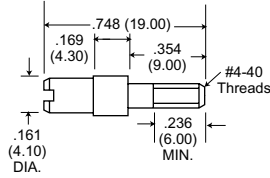
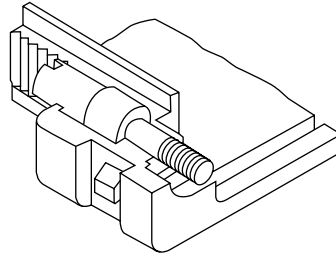

Part Number:	250-8501-010
Material:	Brass
Finish:	Nickel
Quantity Required per Backshell:	2

Thumbscrew

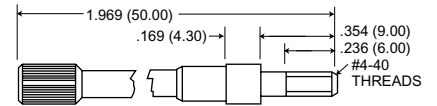
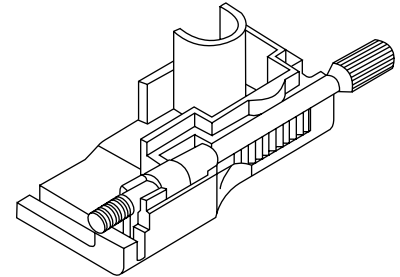

Part Number:	250-8501-013
Material:	Brass
Finish:	Nickel
Quantity Required per Backshell:	2

# Accessories - Shielded Backshells

## Metal Blackshell

### Straight Cable Exit

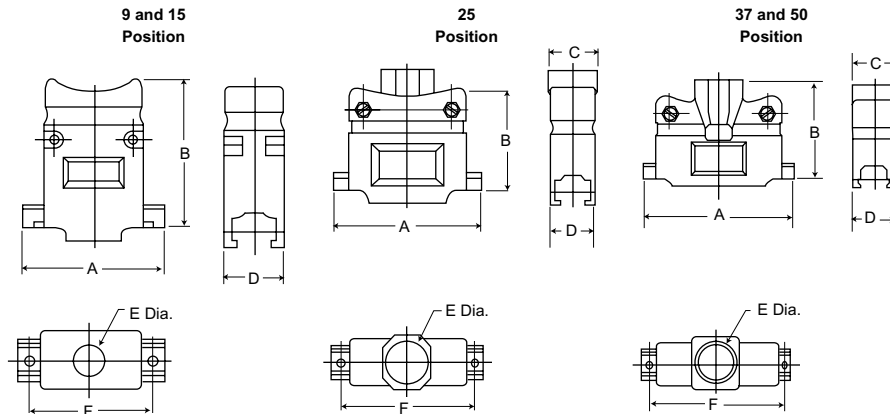

- EMI/RFI protection
- Integral grommet to protect against

### MATERIAL SPECIFICATIONS

Cover:	Die Cast Zinc
Finish:	Clear Zinc Plate
Inserts:	PVC
Hardware:	Steel
Finish:	Clear Zinc

Size	Part Number	A ± .005 (0.13)	B ± .005 (0.13)	C ± .005 (0.13)	D ± .005 (0.13)	E ± .005 (0.13)	F ± .005 (0.13)
9	980-2000-345	1.225 (31.12)	1.465 (37.21)	.620 (15.75)	.620 (15.75)	.400 (10.16)	.984 (24.99)
15	980-2000-346	1.540 (39.12)	1.600 (40.64)	.620 (15.75)	.620 (15.75)	.400 (10.16)	1.312 (33.32)
25	980-2000-347	2.090 (53.09)	1.550 (39.37)	.690 (17.53)	.620 (15.75)	.525 (13.34)	1.857 (47.17)
37	980-2000-348	2.730 (69.34)	1.800 (45.72)	.864 (21.95)	.620 (15.75)	.726 (18.44)	2.500 (63.50)
50	980-2000-349	2.626 (66.70)	1.800 (45.72)	.864 (21.95)	.730 (18.54)	.726 (18.44)	2.406 (61.11)

## Metalized-Plastic Backshell

### Straight Cable Exit

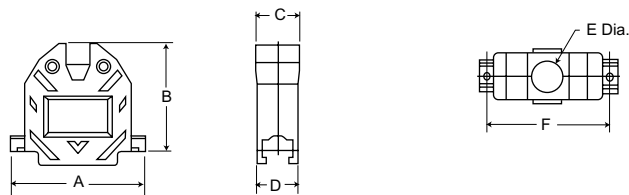

### MATERIAL SPECIFICATIONS

Cover:	ABS Polymer
Finish:	Nickel over Copper
Inserts:	PVC
Hardware:	Steel
Finish:	Clear Zinc

Size	Part Number	A ± .005 (0.13)	B ± .005 (0.13)	C ± .005 (0.13)	D ± .005 (0.13)	E ± .005 (0.13)	F ± .005 (0.13)
9	980-2000-350	1.217 (30.91)	1.547 (39.29)	.640 (16.26)	.640 (16.26)	.400 (10.16)	.984 (24.99)
15	980-2000-351	1.545 (39.29)	1.505 (38.23)	.640 (16.26)	.640 (16.26)	.400 (10.16)	1.312 (33.32)
25	980-2000-352	2.090 (53.09)	1.655 (42.04)	.710 (18.03)	.640 (16.26)	.522 (13.26)	1.857 (47.17)
37	980-2000-353	2.734 (69.44)	1.830 (46.48)	.906 (23.01)	.640 (16.26)	.726 (18.44)	2.500 (63.50)
50	980-2000-354	2.645 (67.18)	1.855 (47.12)	.940 (23.88)	.770 (19.56)	.726 (18.44)	2.406 (61.11)

Highlight part numbers indicate standard product; usually available with shorter lead times.

## Compression Inserts (Included With Backshell)

Accommodates a wide range of cable diameters-

- 9 position - .190/.350
- 15 position - .190/.350
- 25 position - .190/.460
- 37 position - .300/.680
- 50 position - .300/.680

### 9 and 15 Position

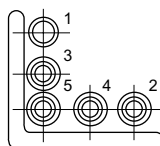

### 25 Position



### 37 and 50 position

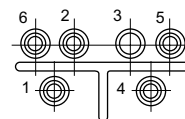

Positions	#1		#2		#3		#4		#5		#6	
	O.D.	I.D.	O.D.	I.D.	O.D.	I.D.	O.D.	I.D.	O.D.	I.D.	O.D.	I.D.
9, 15	0.475 (12.07)	0.320 (8.13)	0.360 (9.14)	0.315 (8.000)	0.360 (9.14)	0.255 (6.48)	0.360 (9.14)	0.285 (7.24)	0.360 (9.14)	0.210 (5.33)	N/A	N/A
25	0.600 (15.24)	0.450 (11.43)	0.450 (11.43)	0.410 (10.41)	0.450 (11.43)	0.370 (9.40)	0.450 (11.43)	0.300 (7.62)	0.450 (11.43)	0.230 (5.84)	N/A	N/A
37, 50	0.655 (16.64)	0.570 (14.48)	0.700 (17.78)	0.620 (15.75)	0.810 (20.57)	0.650 (16.51)	0.655 (16.64)	0.500 (12.70)	0.655 (16.64)	0.425 (10.80)	0.655 (16.64)	0.350 (8.89)

# Accessories - Plastic Backshells

## Universal

- Economical design uses an adjustable tie-wrap for cable strain relief for cable strain relief
- Compatible with male screw locks and spring latches
- U.L. rated 94V-2 (flame retardant)  
248-2670-001 Listing

### Straight

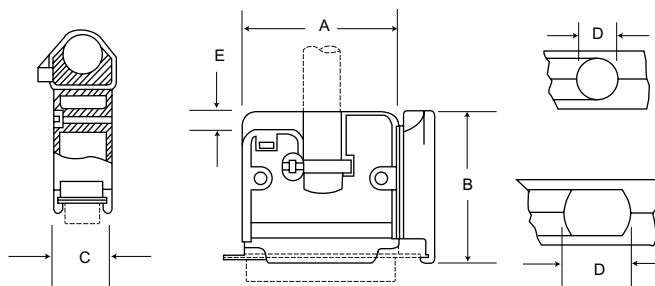

**Material:** Junction shell-polypropylene; Hardware-steel; Tie-wrap-nylon.  
**Finish:** Hardware-cadmium plate, yellow chromate.  
**Color:** Black (junction shell).

Layout	Part Number	$\pm .015$ (0.38)	$\pm .015$ (0.38)	$\pm .015$ (0.13)	$\pm .015$ (0.38)	$\pm .010$ (0.25)
DE-9	DE110963-1	.765 (19.43)	1.400 (35.56)	.600 (15.24)	.250 (6.35)	.125 (3.18)
DA-15	DA110963-2	1.097 (27.86)	1.569 (39.85)	.600 (15.24)	.375 (9.53)	.161 (4.09)
DB-25	DB110963-3	1.641 (41.68)	1.651 (41.94)	.600 (15.24)	.410 (10.41)	.205 (5.21)
DC-37	DC110963-4	2.279 (57.89)	1.899 (48.23)	.600 (15.24)	.593 (15.06)	.205 (5.21)
DD-50	DD110963-5	2.063 (52.40)	1.925 (48.90)	.710 (18.03)	.670 (17.01)	.285 (7.24)

## Snap-Together Universal

- A 2-piece snap-together design for quick assembly
- Customer furnishes tie-wrap

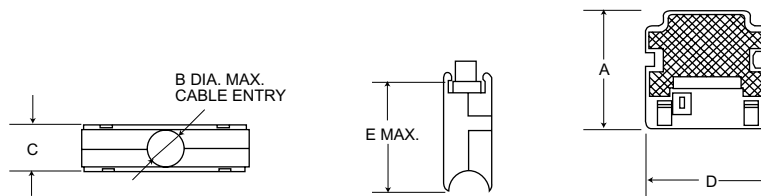

**Material:** Flame-retardant thermoplastic, UL 94V-0 rated.

Layout	Part Number	$\pm .008$ (0.20)	B Max.	$\pm .008$ (0.20)	$\pm .008$ (0.20)	E Max.
DE-9	DE115339-20	1.673 (42.5)	.276 (7.0)	.669 (17.0)	.768 (19.5)	1.555 (39.5)
DA-15	DA115339-21	1.673 (42.5)	.378 (9.6)	.669 (17.0)	1.094 (27.8)	1.555 (39.5)
DB-25	DB115339-22	1.673 (42.5)	.457 (11.6)	.669 (17.0)	1.638 (41.6)	1.555 (39.5)
DC-37	DC115339-23	1.673 (42.5)	.512 (13.0)	.669 (17.0)	2.283 (58.0)	1.555 (39.5)
DD-50	DD115339-24	1.673 (42.5)	.630 (16.0)	.780 (19.8)	2.060 (52.3)	1.555 (39.5)

## One-Piece Snap Together

- Low cost
- Easy to assemble
- Aesthetically pleasing
- Includes: thumbscrews, cable clamps

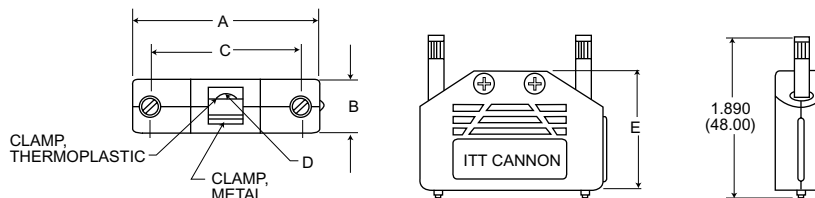

**Material:** Specification: Plastic - polypropylene; Hardware - steel.  
**Finish:** Yellow chromate over zinc.

Layout	Part Number	A	B	C	D Dia. Max.	E
DE-9	DEBS-9	1.386 (35.20)	.638 (16.21)	.984 (24.99)	.224 (5.69)	1.083 (27.51)
DA-15	DABS-15	1.705 (43.31)	.638 (16.21)	1.312 (33.32)	.224 (5.69)	1.228 (31.19)
DB-25	DBBS-25	2.252 (57.20)	.638 (16.21)	1.852 (47.04)	.256 (6.50)	1.508 (38.30)

# Accessories - Plastic Backshells

## One Piece Plastic

- Straight or 90° cable exit
- Integral cable clamp and set screw
- Accommodates spring latches
- UL 94V-2 rated flame retardant
- Mounting hardware included

### Straight Cable Exit

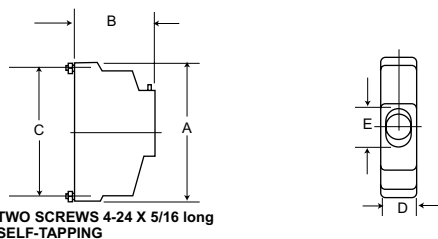

**Material:** Thermoplastic UL 94V-2 rated  
**Color:** Black  
**Screws:** Steel, cadmium plated

Layout	Part Number	A ± .015 (0.38)	B ± .015 (0.38)	C ± .015 (0.13)	C ± .015 (0.38)	E ± .010 (0.25)
DE-9	DE51218	1.218 (30.9)	1.000 (25.4)	.984 (25.0)	.500 (12.7)	.281 (7.1)
DA-15	DA51210	1.546 (39.3)	1.000 (25.4)	1.312 (33.3)	.500 (12.7)	.360 (9.1)
DB-25	DB51212	2.093 (53.2)	1.250 (31.7)	1.852 (47.0)	.500 (12.7)	.493 (12.5)
DC-37	DC51214	2.734 (69.4)	1.500 (38.1)	2.500 (63.5)	.500 (12.7)	.967 (17.6)
DD-50	DD51216	2.640 (67.1)	1.500 (38.1)	2.406 (61.1)	.609 (15.5)	.734 (18.6)

- 90° Cable Exit
- Integral cable clamps & set screw
- UL 94V-2 rated flame retardant
- Mounting Hardware included

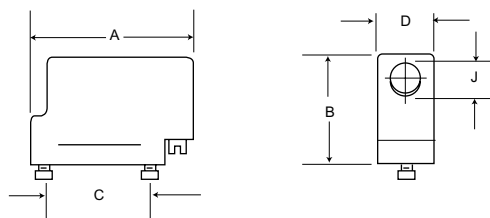

**Material:** Thermoplastic UL 94V-2 rated  
**Color:** Black  
**Screws:** Steel, cadmium plated

Layout	Part Number	A ± .015 (0.38)	B ± .015 (0.38)	C ± .015 (0.13)	C ± .015 (0.38)	E ± .010 (0.25)
DA-15	DA51211	1.822 (46.3)	1.000 (25.4)	1.312 (33.3)	.500 (12.7)	.360 (9.1)
DB-25	DB51213	2.386 (60.1)	1.250 (31.7)	1.852 (47.0)	.500 (12.7)	.493 (12.5)
DC-37	DC51215	3.009 (76.4)	1.500 (38.1)	2.500 (63.5)	.500 (12.7)	.694 (17.6)
DD-50	DD51217	2.915 (74.0)	1.500 (38.1)	2.406 (61.1)	.609 (15.5)	.734 (18.6)

## Dataphone

- Available in 25 position only
- Supplied with screws

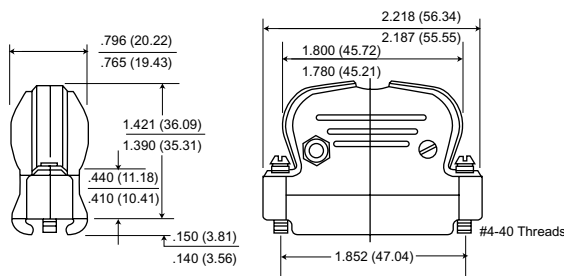

**Max. Cable Entry .312 (7.92)**

**Material:** Junction shell - Thermoplastic UL 94V-0 rated. Hardware - steel.  
**Finish:** Hardware - cadmium plate, clear chromate.  
**Color:** Black  
**Part Number:** DB51226-1B

# Accessories - Plastic Backshells

## Quick-Disconnect Backshells for IDC Cable

### IDC

Order locking hardware separately.

- Optional Spring Clips provide quick disconnect for either flat IDC cable or round jacketed cable
- Designed for use with keying plates sold separately

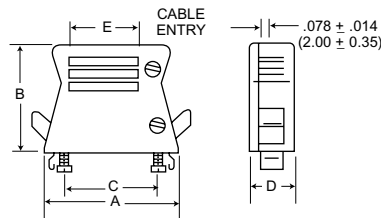

Material: Thermoplastic, UL 94V-0 rated  
Color: Black

Layout	Part Number	A Max.	B Max.	C ± .005 (.013)	D Max.	E ± .008 (0.2)
DE-9	DE115386-1B	1.623 (41.2)	1.596 (40.5)	.984 (25.0)	.642 (16.3)	.590 (15.0)
DA-15	DA115386-2B	1.950 (49.5)	1.596 (40.5)	1.311 (33.3)	.642 (16.3)	.917 (23.3)
DB-25	DB115386-3B	2.490 (63.2)	1.596 (40.5)	1.852 (47.0)	.642 (16.3)	1.456 (37.0)
DC-37	DC115386-4B	3.140 (79.7)	1.596 (40.5)	2.500 (63.5)	.642 (16.3)	2.106 (53.5)

## Quick-Disconnect Backshells for Round Cable

### Round Cable - Straight and 90° Exit

Order locking hardware separately.

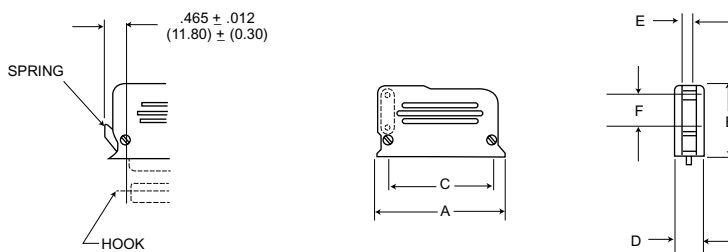

Material: Thermoplastic, UL 94V-0 rated  
Color: Black

Layout	Part Number	A Max.	B Max.	C ± .005 (.013)	D Max.	E ± .008 (0.2)	F Min.
DE-9	DE115339	1.623 (41.2)	1.596 (40.5)	.984 (25.0)	.642 (16.3)	.590 (15.0)	.264 (6.7)
DA-15	DA115339-1	1.950 (49.5)	1.596 (40.5)	1.311 (33.3)	.642 (16.3)	.917 (23.3)	.264 (6.7)
DB-25	DB115339-2	2.490 (63.2)	1.596 (40.5)	1.852 (47.0)	.642 (16.3)	1.456 (37.0)	.697 (17.7)
DC-37	DC115339-3	3.140 (79.7)	1.596 (40.5)	2.500 (63.5)	.642 (16.3)	2.106 (53.5)	.697 (17.7)
DD-50	DD115339-4	3.023 (76.8)	1.653 (42.0)	2.405 (61.1)	.748 (19.0)	.433 (11.0)	.697 (17.7)

## Optional Locking Mechanism/Hardware

Material: Corrosion-resistant steel.

NOTE: When used with keying plate, order lock hook part number 015-8755-001.



**Lock Hook**  
Part No. 015-8755-000  
Order 2 per connector  
Note: Not for use on rear panel mounted connectors.

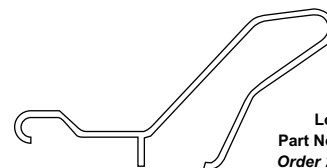

**Lock Spring**  
Part No. 259-8760-000  
Order 2 per connector

# Accessories - Locking Hardware

## Screw Locks

- ¥ Insures positive mating.
- ¥ Used for vibration applications.

Front Panel Mount

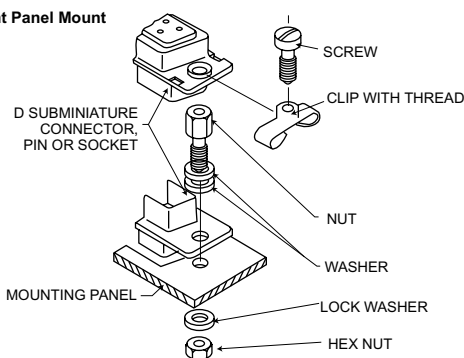

Rear Panel Mount

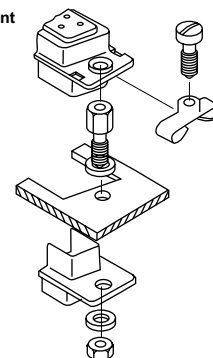

### Female Srew Locks

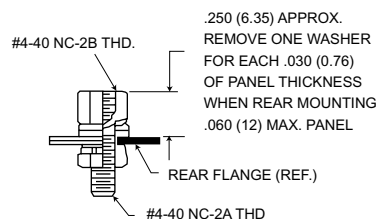
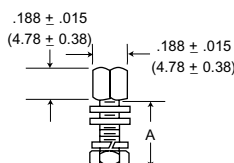

Order 2 per connector.

Cadmium With Yellow Chromate	M24308 MIL-Spec.	A ± .015 (0.38)
D20418-2	M24308/26-1	.312 (7.92)
D20418-50		.500 (12.70)
D20418-39	M24308/26-2	.625 (15.88)
D20418-74		.750 (19.05)

Material: Cold rolled steel.

Finish: Cadmium plate, yellow chromate

NOTE: (1) A 6 inch/pound (female) and 4 inch/pound (male) maximum torque during assembly is recommended on steel screw lock assemblies.

(2) A third flat washer is supplied for front panel mounting of tab shell connectors.

### NM For Use With Non-Magnetic/No-Dutgas Products

NM Brass	NM Stainless Steel	A ± .015 (0.38)
D20418-52	D20418-14	.312 (7.92)
N/A	D20418-102	.500 (12.70)
D20418-101	D20418 -77	.625 (15.88)

### NM - Non-Magnetic Finish and Material:

Passivated (Stainless Steel). Gold over copper per MIL-G-45204, Type II, Class 2 (Brass)

### Male Srew Locks

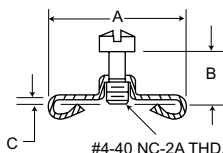

Standard Material: Clip-sheet steel; hardware-cold rolled steel.

Standard Finis: Cadmium plate, yellow chromate.

Commercial: 100 microinch zinc minimum.

Passivated (Stainless Steel). Gold over copper per MIL-G45204, Type II, Class 2 (Brass).

Order 2 per connector.

Cadmium With Yellow Chromate	NM Brass	NM Stainless Steel	A ± .015 (0.38)	B ± .010 (0.25)	C ± .005 (0.13)	Connector Size
D20419	D20419-74	N/A	.555 (14.10)	.250 (6.35)	.048 (1.22)	DE9, DA15, DB25, DC37
D20419-18	D20419-103	D20419-38	.555 (14.10)	.281 (7.14)	.067 (1.70)	DE9, DA15, DB25, DC37
D20419-21	N/A	D20419-80	.555 (14.10)	.281 (7.14)	.092 (2.34)	DE9, DA15, DB25, DC37
D20419-104	N/A	N/A	.555 (14.10)	.312 (7.92)	.092 (2.34)	DE9, DA15, DB25, DC37
D20420	D20419-67	N/A	.656 (16.66)	.250 (6.35)	.048 (1.22)	DD50
D20420-13	D20419-74	D20419-108	.656 (16.66)	.281 (7.14)	.067 (1.70)	DD50
D20420-15	N/A	D20419-70	.656 (16.66)	.281 (7.14)	.092 (2.34)	DD50
D20420-86	N/A	N/A	.656 (16.66)	.312 (7.92)	.092 (2.34)	DD50

NM - Non-Magnetic Finish & Material: Passivated (Stainless Steel). Gold over copper per MIL-G-4520, Type II, Class 2 (Brass).

NOTE: (1) A 6 inch/pound (female) and 4 inch/pound (male) maximum torque during assembly is recommended on steel screw lock assemblies.

(2) A third flat washer is supplied for front panel mounting of tab shell connectors.

Highlighted part numbers indicate standard product; usually available with shorter lead times.

# Accessories - Locking Hardware

## Slide Latch Assemblies

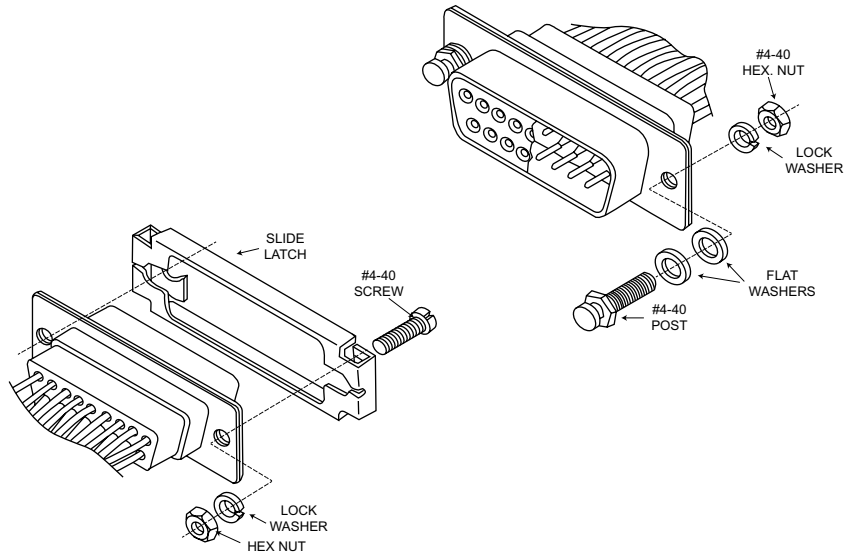

### Slide Lock Post Kit



Kit consists of 1 post, 2 spacer washers, 1 lock washer and hex nut.

Order 2 per connector.

Material	Cadmium With Yellow Chromate
Steel	D53018
Brass	D53018-5

NOTE: When rear-mounting connector to a 1/16" panel, delete the 2 spacer washer.

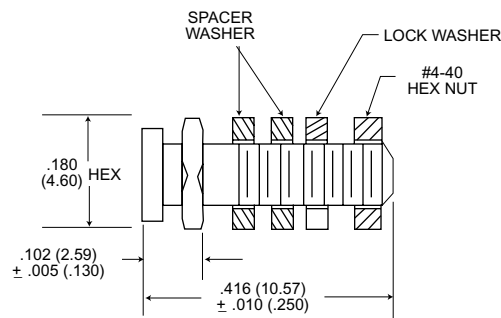

### Slide Latch Kit

- Ideal for Ethernet Applications



Kit consists of slide latch retainer, 2 screws, 2 nuts, 2 lock washer.

Order one per connector.

Description	Material	Finish
Retainer Sliding lock	Stainless Steel per QQ-S-766	Passivated per QQ-P-35
Screw, Mtg,		Yellow chromate over 100 micro-inch cadmium per QQ-P-416.
Washer, Lock	Steel	
Nut, Hex		

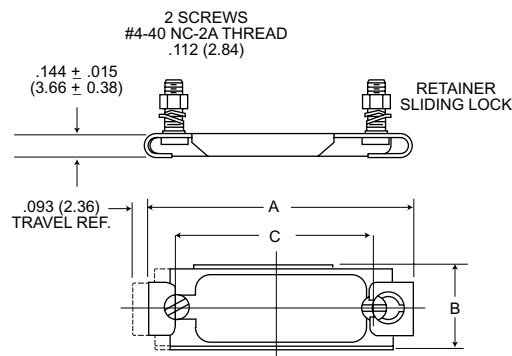

Layout	Cadmium With Yellow Chromate	A ± .015 (0.38)	B ± .015 (0.38)	C ± .005 (0.13)
DE-9	DE51224-1	1.380 (35.05)	.500 (12.70)	.984 (25.00)
DA-15	DA51220-1	1.720 (43.69)	.500 (12.70)	1.312 (33.32)
DB-25	DB51221-1	2.260 (57.40)	.500 (12.70)	1.852 (47.04)
DC-37	DC51222-1	2.908 (73.86)	.500 (12.70)	2.500 (63.50)
DD-50	DD51223-1	2.814 (71.47)	.609 (15.47)	2.406 (61.11)

Highlighted part numbers indicated standard product; usually available with shorter lead times.

# Accessories - Locking Hardware

## Spring Latch Assemblies

- Low cost
- Minimizes field connection time
- Positive lock between connectors

Locked

Unlocked

### Spring Latch Plate

Kit consists of 1 plate, 1 screw, 1 lock washer, 1 nut.

Order two per connector.

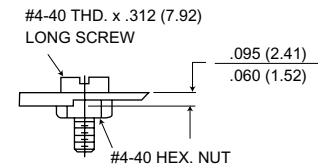
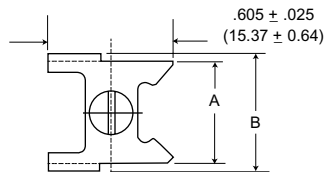
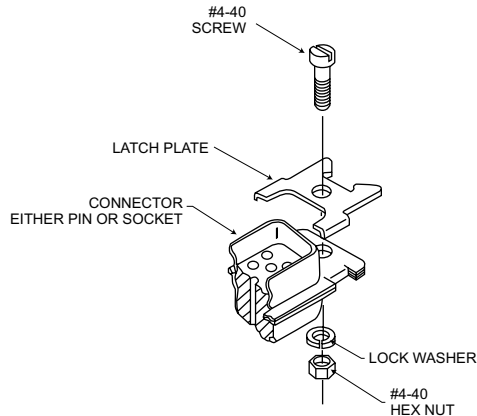

Material: Stainless Steel  
Finish: Passivated

Layout	Part Number	A ± .015 (0.38)	B ± .015 (0.38)
DE-9 thru DC-37	D110278	.484 (12.29)	.556 (14.12)
DD-50 Only	D110280	.609 (15.49)	.673 (17.09)

### Spring Latch

Kit consists of 1 spring, 1 screw, 1 bracket, 1 lock washer, and 1 hex nut.

Order two per connector.

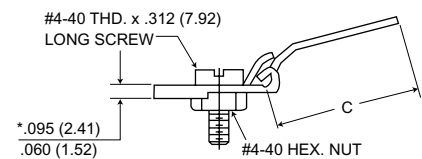
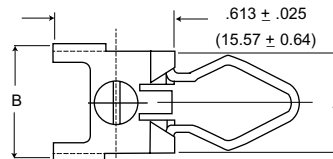
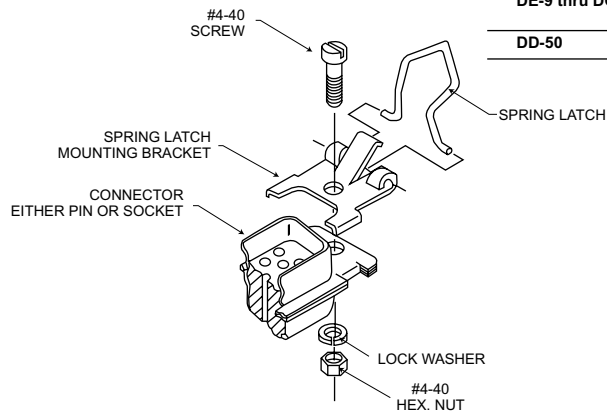

\* Does not apply to rear panel mounting.

Material: Stainless Steel  
Finish: Passivated

Layout	Mounting	Part Number	A ± .015 (0.38)	B ± .015 (0.38)	C ± .020 (0.51)
DE-9 thru DC-37	Front Panel	DD10277	.489 (12.42)	.565 (14.35)	.732 (18.59)
	Rear Panel	D110277-4	.489 (12.42)	.605 (15.37)	.615 (15.62)
DD-50	Front Panel	D110279	.609 (15.49)	.673 (17.09)	.732 (18.59)

Highlighted part numbers indicate standard product; usually available with shorter lead times.



# Accessories - Locking Hardware

## Jackscrew/Jackpost Assemblies

### Jackpost - P/N D110551

Kit consists of 2 posts, 2 nuts, 2 lockwashers.

**Order one per connector.**

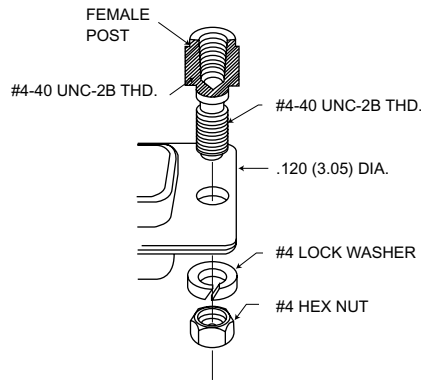

JACKPOSTS ASSEMBLY

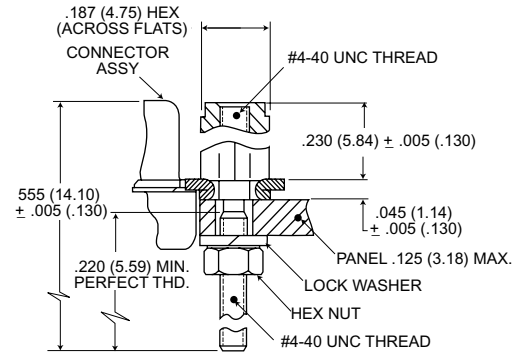

**Material: Stainless Steel per QQ-S-763**  
**Finish: Passivated per QQ-P-35**

Note: Jackpost is not compatible with rear-panel mounted connectors.

### Jackscrew - P/N D110550

Kit consists of 2 studs, 2 heads, and 1 tube retaining compound.

**Order one per connector.**

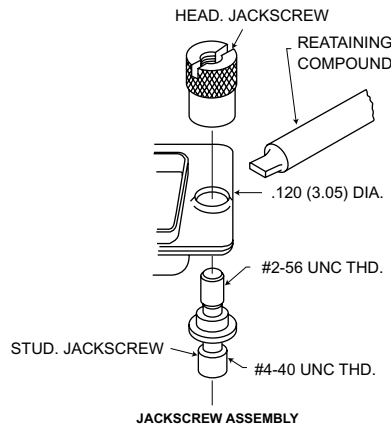

JACKSCREW ASSEMBLY

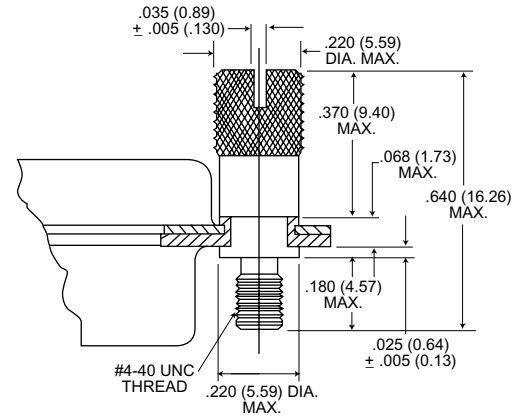

**Material: Stainless Steel per QQ-S-763**  
**Retaining Compound: per MIL-S-46163**  
**Finish: None**

## Jackscrew/Jackpost Assemblies

Nylon potting shells are molded with a thin flange .030 (0.76) to permit the use of D subminiature locking devices.  
Holds epoxy in place during curing.

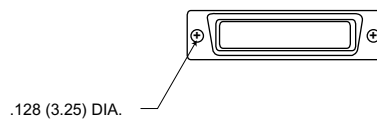

**Material: Nylon**  
**Color: Natural (white)**

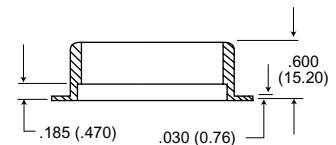

Layout	Part Number
DE-9	DE50904-1
DA-15	DA50905-1
DB-25	DB50906-1
DC-37	DC50907-1
DD-50	DD50908-1

Highlighted part numbers indicated standard product; usually available with shorter lead times.

## Guide Pin Plates

Female

### Blind Mate Applications



#### Materials

**Plate:** Cold rolled steel per ASTM A-620, yellow chromate over cadmium plate per QQ-P-416 Type II, Class 2

**Screw:** Steel, yellow chromate over 100 microinches cadmium minimum per QQ-P-416.

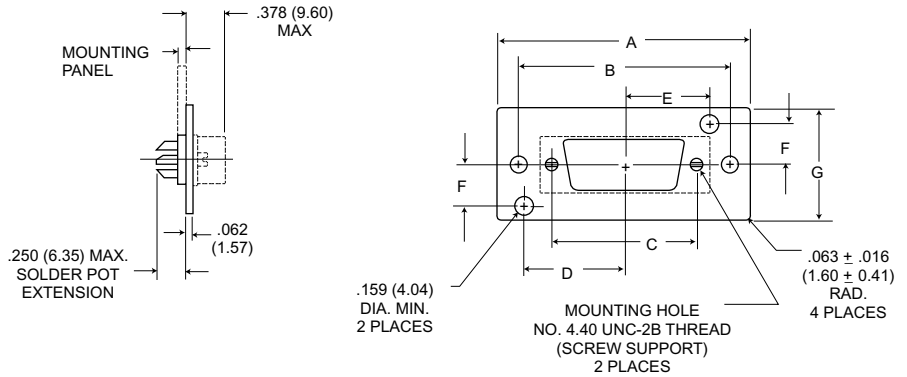

### Recommended Panel Cutout

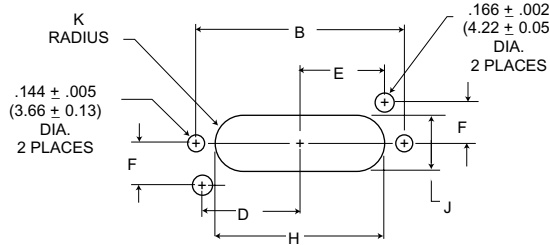

Layout	Part Number	A ± .016 (0.41)	B ± .005 (0.13)	C ± .005 (0.13)	D ± .005 (0.13)	E ± .005 (0.13)	F ± .005 (0.13)	G ± .016 (0.41)	H ± .016 (0.41)	J ± .016 (0.41)	K ± .016 (0.41)
DA-15	DA22214	2.282 (57.96)	1.906 (48.41)	1.312 (33.32)	.898 (22.81)	.765 (19.43)	.375 (9.52)	1.000 (25.40)	1.532 (38.91)	.484 (12.29)	.242 (6.15)
DB-25	DB22254	2.820 (71.63)	2.446 (62.13)	1.852 (47.04)	1.168 (29.67)	1.035 (26.29)	.375 (9.52)	1.000 (25.40)	2.016 (51.21)	.469 (11.91)	.234 (5.94)
DC-37	DC22071	3.469 (88.11)	3.094 (78.59)	2.500 (63.50)	1.492 (37.90)	1.359 (34.52)	.375 (9.52)	1.000 (25.40)	2.657 (67.49)	.469 (11.91)	.234 (5.94)
DD-50	DD21961	3.375 (85.72)	3.000 (76.20)	2.406 (61.11)	1.437 (36.50)	1.312 (33.32)	.437 (11.10)	1.125 (28.58)	2.563 (65.10)	.563 (14.30)	.282 (7.16)

Consult factory for DC size.

Male

### Blind Mate Applications



#### Materials

**Guide Pin:** 303 stainless steel per MIL-S-7720 Cond. A, passivated per QQ-P-35

**Screws, Rivets, Washers:** Steel, Yellow chromate over 100 microinches cadmium minimum per QQ-P-416

**Plate:** Cold rolled steel per ASTM A-620, yellow chromate over cadmium plate per QQ-P-416, Type II, Class 2

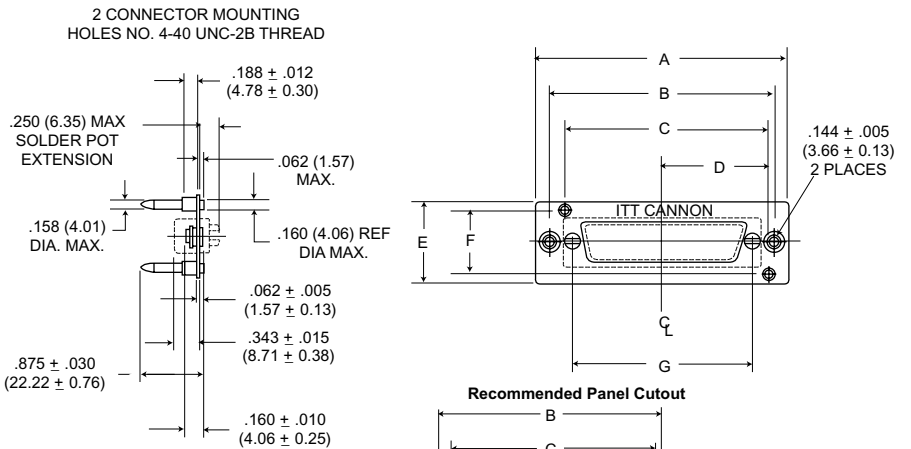

### Recommended Panel Cutout

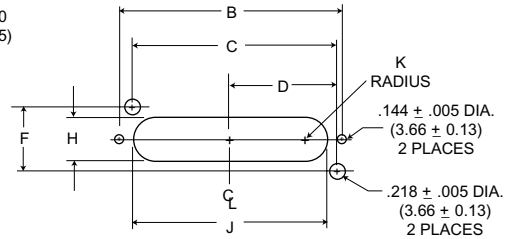

Layout	Part Number	A ± .015 (0.38)	B ± .005 (0.13)	C ± .010 (0.23)	D ± .005 (0.13)	E ± .015 (0.38)	F ± .010 (0.23)	G ± .005 (0.13)	H ± .010 (0.25)	J ± .015 (0.38)	K ± .005 (0.13)
DA-15	DA22213	2.281 (57.94)	1.906 (48.41)	1.663 (42.24)	.898 (22.81)	1.000 (25.40)	.750 (19.05)	1.312 (33.32)	.484 (12.29)	1.531 (38.89)	.242 (6.15)
DB-25	DB22255	2.820 (71.63)	2.446 (62.13)	2.203 (55.96)	1.168 (29.67)	1.000 (25.40)	.750 (19.05)	1.852 (47.04)	.484 (12.29)	2.047 (51.99)	.242 (6.15)
DC-37	DC22070	3.468 (88.09)	3.094 (78.42)	2.851 (72.42)	1.492 (37.90)	1.000 (25.40)	.750 (19.05)	2.500 (63.50)	.484 (12.29)	2.687 (68.25)	.242 (6.15)
DD-50	DD21962	3.375 (85.72)	2.300 (58.42)	2.749 (69.82)	1.437 (36.50)	1.125 (28.58)	.874 (22.20)	2.406 (61.11)	.593 (15.06)	2.635 (66.93)	.296 (7.52)

Consult factory for DC size.

# Accessories

## Combo D Guide Pin and Socket

Installs into any Combo D, size 8 Cavity. This patented guide pin and socket system is ideal for blind mate applications where space is limited.



Description	Material	Finish
Guide Pin	Brass	Gold over nickel
Guide Socket	Copper Alloy	Gold over nickel

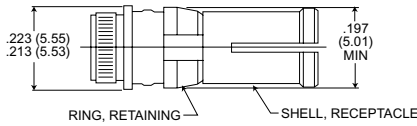

**Press Fit Guide Socket**  
P/N DM53744-72

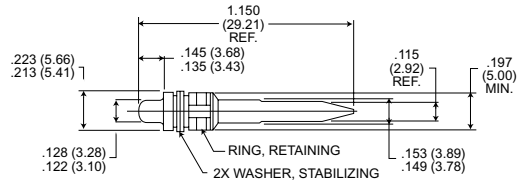
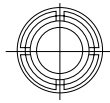

**PCB Guide Pin**  
P/N DM53745-82

## Dust Caps

Anti-static conductive dust caps (black polypropylene) protect connectors and contacts from dust and moisture.

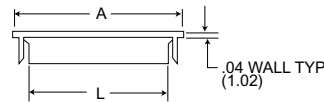
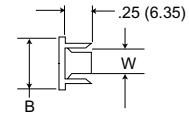
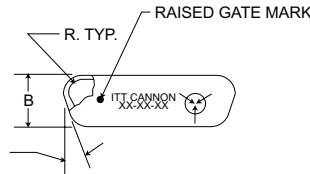

**NOTE:** L dim. applies at point of maximum internal interface length.

Part Numbers	I.D.	A	B	L	W
DE-59-20	Pin	.80 (20.32)	.45 (11.43)	.644 (16.36)	.299 (7.59)
DA-59-20	Pin	1.12 (28.45)	.46 (11.68)	.968 (24.59)	.300 (7.62)
DB-59-20	Pin	1.67 (42.42)	.46 (11.68)	1.506 (38.25)	.295 (7.49)
DC-59-20	Pin	2.32 (58.93)	.46 (11.68)	2.158 (54.81)	.290 (7.37)
DD-59-20	Pin	2.24 (56.90)	.57 (14.48)	2.091 (53.11)	.410 (10.41)
DE-60-20	Socket	.86 (21.84)	.51 (12.95)	.700 (17.78)	.351 (8.92)
DA-60-20	Socket	1.20 (30.48)	.51 (12.95)	1.044 (26.52)	.355 (9.02)
DB-60-20	Socket	1.74 (44.20)	.53 (13.46)	1.559 (39.60)	.358 (9.09)
DC-60-20	Socket	2.39 (60.71)	.53 (13.46)	2.240 (56.90)	.369 (9.37)
DD-60-20	Socket	2.29 (58.17)	.63 (16.00)	2.137 (54.28)	.474 (12.04)

## Interfacial Seal

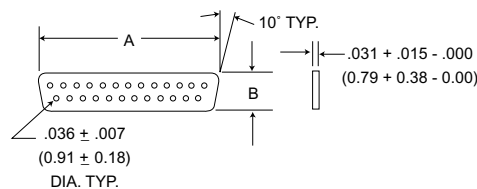

Layout	Part Number	A	B
DE-9	DE53750	.656 (16.7)	.331 (8.4)
DA-15	DA53750-1	.984 (25.0)	.331 (8.4)
DB-25	DB53750-2	1.531 (38.9)	.331 (8.4)
DC-37	DC53750-3	2.171 (55.1)	.331 (8.4)
DD-50	DD53750-4	2.078 (52.8)	.437 (11.1)

Material: Silastic sheet

Provides moisture resistance at the mating interface.

# Accessories - Gender Changers & Connector Savers

## Performance and Material Specifications

### MATERIALS AND FINISHES

		Material	Finish
Contacts		Copper Alloy	Gold Over Nickel
Rivets		Copper Alloy	Tin/Lead
Shells		Steel	Tin/Lead
Insulator (Gender Changer):	M/M	Glass Epoxy	-
	F/F	Thermo Plastic	-
Spacer		Zinc Alloy	-
Locking Nut		Steel	Clear Chromate Over Cadmium
Washers		Steel	Clear Chromate Over Cadmium
Washer, Captive		Mylar	None

### MECHANICAL FEATURES

Coupling - Friction and lock accessories  
Polarization - Keystone-shaped shells

### PERFORMANCE SPECIFICATIONS

Temperature Rating: -55° to +105° C  
Current Rating: 3 Amp continuous  
Dielectric Withstanding Voltage: 500 VAC at Sea Level

## Dimensions/Part Numbers

### Gender Changer Male/Male

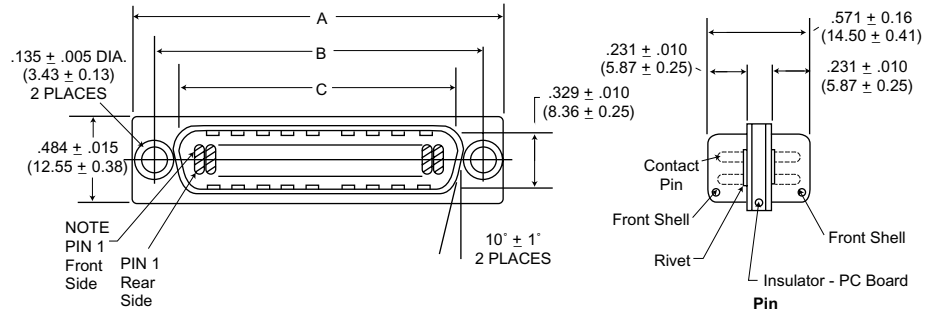

### Gender Changer Female/Female

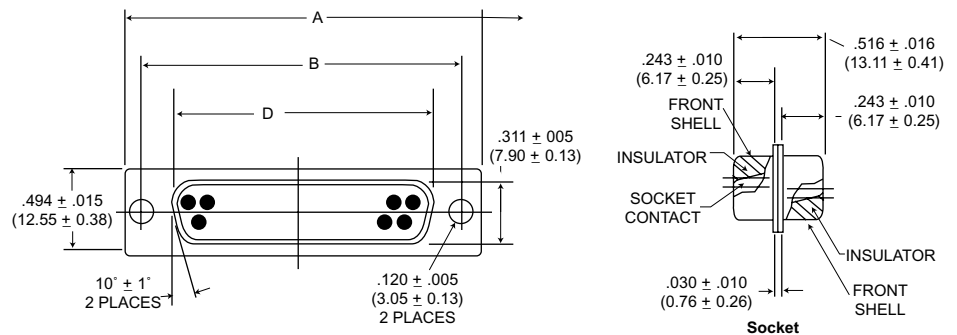

### Connector Saver

#### Engaging View, Pin Side

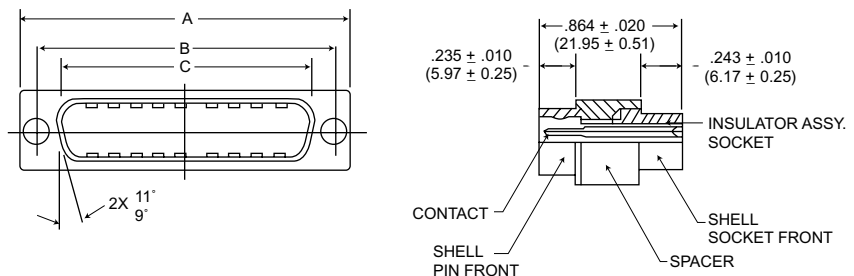

Number of Contacts (Shell Size)	Gender Changer Part Numbers				Connectors Saver Part Numbers	A ± .015 (0.4)	B ± .010 (0.25)	C ± .010 (0.25)	D ± .005 (0.13)
	Male/Male		Female/Female						
	Without Hardware	With Hardware Assembled	Without Hardware	With Hardware Assembled					
9 (E)	DE111805-1	DE11805-5	DE111813	DE111813-3	DEBU111515	1.213 (30.81)	.984 (24.99)	.666 (16.92)	.643 (16.33)
15 (A)	DE111806-1	DA11806-5	DA111810	DA111810-3	DABU111512	1.541 (39.14)	1.312 (33.32)	.994 (25.25)	.971 (24.66)
25 (B)	DE111807-1	DB11807-5	DB111811	DB111811-2	DBBU111511	2.088 (53.04)	1.852 (47.04)	1.534 (38.96)	1.511 (38.38)
37 (C)	DE111808-1	DC11808-5	Not Available	Not Available	Not Available	2.729 (69.32)	2.500 (63.50)	2.182 (55.42)	††

## Panel Cutouts

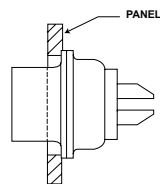

Rear mounting of standard shell

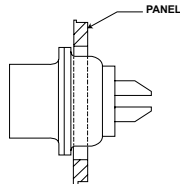

Front mounting of standard shell

### Standard Cutout

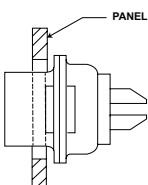
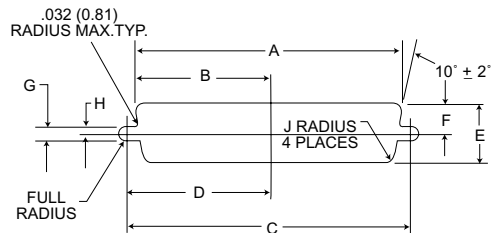

Rear mounting of float mount shell (Y-Code)

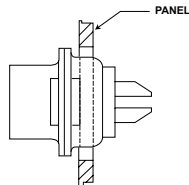

Front mounting of reverse mount shell (Y-Code)

### Optional Cutout (For Rear Mounting)

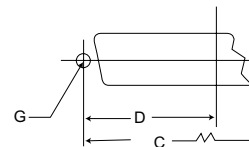

Connector Size	Mounting Method	A ± .005 (0.13)	B ± .005 (0.13)	C ± .005 (0.13)	D ± .005 (0.13)	E ± .005 (0.13)	F ± .005 (0.13)	G ± .002 (0.05)	H ± .002 (0.05)	J ± .002 (0.05)
A Standard	Front Mounting	1.202 (30.53)	.601 (15.26)	1.312 (33.32)	.656 (16.66)	.513 (13.03)	.257 (6.52)	.120 (3.04)	.060 (1.52)	.083 (2.10)
	Rear Mounting	1.134 (28.80)	.567 (14.40)	1.312 (33.32)	.656 (16.66)	.449 (11.40)	.225 (5.71)	.120 (3.04)	.060 (1.52)	.132 (3.35)
A Float	Front Mounting	1.234 (31.34)	.617 (15.67)	1.312 (33.32)	.656 (16.66)	.545 (13.84)	.273 (6.93)	.088 (2.23)	.044 (1.11)	.083 (2.10)
	Rear Mounting	1.166 (29.61)	.583 (14.80)	1.312 (33.32)	.656 (16.66)	.481 (12.21)	.241 (6.12)	.088 (2.23)	.044 (1.11)	.132 (3.35)
B Standard	Front Mounting	1.743 (44.27)	.872 (22.14)	1.852 (47.04)	.926 (23.52)	.513 (13.03)	.257 (6.52)	.120 (3.04)	.060 (1.52)	.083 (2.10)
	Rear Mounting	1.674 (42.51)	.837 (21.25)	1.852 (47.04)	.926 (23.52)	.449 (11.40)	.225 (5.71)	.120 (3.04)	.060 (1.52)	.132 (3.35)
B Float	Front Mounting	1.775 (45.08)	.888 (22.55)	1.852 (47.04)	.926 (23.52)	.545 (13.84)	.273 (6.93)	.088 (2.23)	.044 (1.11)	.083 (2.10)
	Rear Mounting	1.706 (43.33)	.853 (21.66)	1.852 (47.04)	.926 (23.52)	.481 (12.21)	.241 (6.12)	.088 (2.23)	.044 (1.11)	.132 (3.35)
C Standard	Front Mounting	2.391 (60.73)	1.196 (30.37)	2.500 (63.50)	1.250 (31.75)	.513 (13.03)	.257 (6.52)	.120 (3.04)	.060 (1.52)	.083 (2.10)
	Rear Mounting	2.326 (59.08)	1.163 (29.54)	2.500 (63.50)	1.250 (31.75)	.449 (11.40)	.225 (5.71)	.120 (3.04)	.060 (1.52)	.132 (3.35)
C Float	Front Mounting	2.423 (61.54)	1.212 (30.78)	2.500 (63.50)	1.250 (31.75)	.545 (13.84)	.273 (6.93)	.088 (2.23)	.044 (1.11)	.083 (2.10)
	Rear Mounting	2.354 (59.79)	1.177 (29.89)	2.500 (63.50)	1.250 (31.75)	.481 (12.21)	.241 (6.12)	.088 (2.23)	.044 (1.11)	.132 (3.35)
D Standard	Front Mounting	2.297 (58.34)	1.149 (29.18)	2.406 (61.11)	1.203 (30.55)	.623 (15.82)	.312 (7.92)	.120 (3.04)	.060 (1.52)	.083 (2.10)
	Rear Mounting	2.218 (56.33)	1.109 (28.16)	2.406 (61.11)	1.203 (30.55)	.555 (14.09)	.278 (7.06)	.120 (3.04)	.060 (1.52)	.132 (3.35)
D Float	Front Mounting	2.329 (59.15)	1.165 (29.59)	2.406 (61.11)	1.203 (30.55)	.655 (16.63)	.328 (8.33)	.088 (2.23)	.044 (1.11)	.083 (2.10)
	Rear Mounting	2.250 (57.15)	1.125 (28.57)	2.406 (61.11)	1.203 (30.55)	.587 (14.90)	.294 (7.46)	.088 (2.23)	.044 (1.11)	.132 (3.35)
E Standard	Front Mounting	.874 (22.19)	.437 (11.09)	.984 (24.99)	.492 (12.49)	.513 (13.03)	.257 (6.52)	.120 (3.04)	.060 (1.52)	.083 (2.10)
	Rear Mounting	.806 (20.47)	.403 (10.23)	.984 (24.99)	.492 (12.49)	.449 (11.40)	.225 (5.71)	.120 (3.04)	.060 (1.52)	.132 (3.35)
E Float	Front Mounting	.906 (23.01)	.453 (11.50)	.984 (24.99)	.492 (12.49)	.545 (13.84)	.273 (6.93)	.088 (2.23)	.044 (1.11)	.083 (2.10)
	Rear Mounting	.838 (21.28)	.419 (10.64)	.984 (24.99)	.492 (12.49)	.481 (12.21)	.241 (6.12)	.088 (2.23)	.044 (1.11)	.132 (3.35)

## Panel Mounting

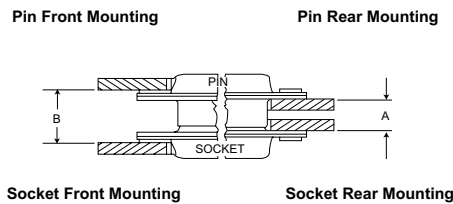

Figure 1A

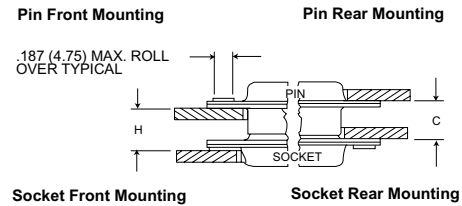

Figure 1B

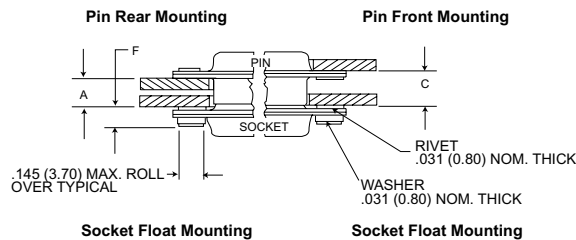

Figure 2

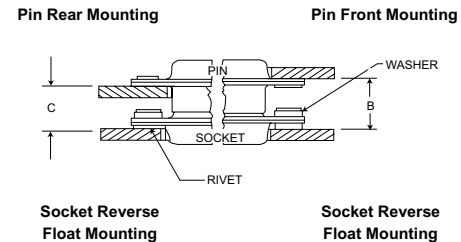

Figure 3

NOTE:

1. A, B, C and H are dimensions between panels and represent the recommended limit to be used in the design of the connector mounting method.
2. It is recommended that only one assembly, either pin or socket, be float mounted.
3. Standard pin assemblies contained .015 (0.38) thick front shells on E and A sizes; .024 (.061) thick front shells on B, C, and D sizes.
4. Standard connectors accommodate a #4 screw. Float mount connectors accommodate a #2 screw.

Fig. No.	Size	Pin (See Note Below)	Socket	A	B	C	F	H
				+ .030 (+0.76) - .000 (-0)	+ .030 (+0.76) - .000 (-0)	+ .030 (+0.76) - .000 (-0)	± .010 (±.025)	+ .030 (+0.76) - .000 (-0)
1	A, E	Standard	Standard	.250 (6.35)	.340 (8.63)	.295 (7.49)	-	.295 (7.49)
1	B, C, D	Standard	Standard	.238 (6.04)	.343 (8.71)	.298 (7.56)	-	.283 (7.18)
2	A, E	Standard	Float Mount	.218 (5.53)	-	.263 (6.68)	.120 (3.04)	-
2	B, C, D	Standard	Float Mount	.206 (5.23)	-	.266 (6.75)	.120 (3.04)	-
2	A, E	Float Mount	Standard	.218 (5.53)	-	.263 (6.68)	.120 (3.04)	-
2	B, C, D	Float Mount	Standard	.206 (5.23)	-	.251 (6.37)	.130 (3.30)	-
3	A, E	Standard	Rev. Float Mount	-	.358 (9.09)	.313 (7.95)	.120 (3.04)	-
3	B, C, D	Standard	Rev. Float Mount	-	.361 (9.16)	.301 (7.64)	.120 (3.04)	-
3	A, E	Rev. Float Mount	Standard	-	.358 (9.09)	.313 (7.95)	.120 (3.04)	-
3	B, C, D	Rev. Float Mount	Standard	-	.355 (9.01)	.310 (7.87)	.130 (3.30)	-

## MIL-C-24308 Test Extracts Applicable to Class G Connectors

Test Descriptions	Requirement			Method
	Shell Size	Max Unmating (LBS)	Max Mating (LBS)	
Mating/Unmating Force	1	6	10	MIL-STD-1344 Method 2013
	2	10	17	
	3	17	28	
	4	24	39	
	5	30	49	
Contact Retention	Contacts shall be retained in their inserts by a 9 pound (minimum) force. The axial displacement of contacts shall not exceed .012 inch while under load.			MIL-STD-1344 Method 2004
Insulation Resistance	After humidity 1 Megohm (min) All other conditions 5000 Megohm (mm).			MIL-STD-1344 Method 3003
Contact Resistance	After salt spray not to exceed 55 millivolts max.			#20 AWG, 7.5 Amp MIL-STD-1344 Method 3004
Vibration	No damage and no loosening of parts due to vibration. No interruption of electrical continuity longer than 1 microsecond.			MIL-STD-1344 Method 2005 Test Cond. 4
Shock	No damage and no loosening of parts. No interruption of electrical continuity longer than 1 microsecond.			MIL-STD-1344 Method 2004 Test Cond. E
Durability	No electrical or mechanical defects after 500 cycles of mating and unmating			MIL-STD-1344 Method 2016 200 ± 100 cycles/hour
Salt Spray (Corrosion)	No exposure of base metal due to corrosion which will affect performance. Product will meet further test as specified.			MIL-STD-1344 Method 1001 Cond. B
Fluid Immersion	20 hours, immersion MIL-H-5606 Hydraulic Fluid 20 hours, immersion MIL-L-23659 Lubricating Fluid Connectors shall meet mating/unmating force following immersion.			MIL-STD-1344 Method 1016

# MIL-C-39029 Crimp Contacts

Military Part Number	ITT Cannon Part Number	Contact Size	Contact Style	Product Line	MIL Specification	Pages		
M39029/4-110	030-9173-006	20	Pin	DPK, PV	MIL-C-83733 MIL-C-26482, Series 2	75-91 157-166		
M39029/4-111	030-9205-007	16	Pin	DPK, PV				
M39029/4-113	030-9185-003	12	Pin	DPK, PV				
M39029/5-115	031-9174-004	20	Soc	DPK, PV				
M39029/5-116	031-9206-006	16	Soc	DPK, PV				
M39029/5-118	031-9186-003	12	Soc	DPK, PV				
M39029/11-144	030-1975-008	22	Pin	DPX*, DPK*	MIL-C-81659	25-40		
M39029/11-145	030-1892-004	20	Pin	DPX*				
M39029/11-146	030-9083-012	16	Pin	DPX*				
M39029/11-147	030-1909-002	12	Pin	DPX*				
M39029/12-148	031-1113-008	22	Soc	DPX*				
M39029/12-149	031-1047-003	20	Soc	DPX*				
M39029/12-150	031-1271-000	16	Soc	DPX*				
M39029/12-151	031-1059-003	12	Soc	DPX*				
M39029/29-212	030-3196-008	16	Pin	MS/CV345*			MIL-C-5015	188-195
M39029/29-213	030-3197-007	12	Pin	MS/CV345*				
M39029/29-214	030-3198-003	8	Pin	MS/CV345*				
M39029/29-215	030-3199-004	4	Pin	MS/CV345*				
M39029/29-216	030-3200-003	0	Pin	MS/CV345*				
M39029/30-217	031-3113-005	16S	Soc	MS/CV345*				
M39029/30-218	031-3114-008	16	Soc	MS/CV345*				
M39029/30-219	031-3115-006	12	Soc	MS/CV345*				
M39029/30-220	031-3116-003	8	Soc	MS/CV345*				
M39029/30-221	031-3117-003	4	Soc	MS/CV345*				
M39029/30-222	031-3118-003	0	Soc	MS/CV345*				
M39029/31-228	030-9032-003	16	Pin	KPSE	MIL-C-26482, Series I	140-156		
M39029/31-240	030-9036-000	20	Pin	KPSE				
M39029/32-247	031-9095-003	16	Soc	KPSE				
M39029/32-259	031-9074-002	20	Soc	KPSE				
M39029/50-340	249-1825-001	12	Pin	DPK (Coax)	MIL-C-83733	75-91		
M39029/51-341	249-1826-000	12	Soc	DPK (Coax)				
M39029/56-348	031-1147-007	22D	Soc	KJL/KJA	MIL-C-38999, Series I, II, III	115-139		
M39029/56-351	031-1250-001	20	Soc	KJL/KJA				
M39029/56-352	031-1251-001	16	Soc	KJL/KJA				
M39029/56-353	031-1237-000	12	Soc	KJL/KJA				
M39029/57-354	031-1147-000	22D	Soc	KJ & DPK*	MIL-C-38999, Series II	122-127		
M39029/57-355	031-1122-022	22M	Soc	KJ Only				
M39029/57-356	031-1125-022	22	Soc	KJ Only				
M39029/57-357	031-1124-020	20	Soc	KJ Only				
M39029/57-358	031-1123-016	16	Soc	KJ Only				
M39029/57-359	031-1238-000	12	Soc	KJ Only				
M39029/58-360	030-2042-000	22D	Pin	KJL/KJ/KJA & DPK			MIL-C-38999, Series I, II, III	115-139
M39029/58-361	030-1993-022	22M	Pin	KJL/KJ/KJA				
M39029/58-362	030-1999-022	22	Pin	KJL/KJ/KJA				
M39029/58-363	030-1997-020	20	Pin	KJL/KJ/KJA				
M39029/58-364	030-1995-016	16	Pin	KJL/KJ/KJA				
M39029/58-365	030-2155-000	12	Pin	KJL/KJ/KJA				
M39029/63-368	031-1007-042	20	Soc	D*MA	MIL-C-24308	332-344		
M39029/64-369	330-5291-037	20	Pin	D*MA				
M39029/83-450	030-8008-800	2022	Pin	KFS-(Canada)	MIL-C-28840	218-223		
M39029/83-451	030-8009-100	2028	Pin	KFS-(Canada)				
M39029/83-508	030-8085-700	2020	Pin	KFS-(Canada)				
M39029/84-452	031-8004-300	2022	Soc	KFS-(Canada)				
M39029/84-453	031-8004-400	2028	Soc	KFS-(Canada)				
M39029/84-509	031-8005-700	2020	Soc	KFS-(Canada)				

## X-ON Electronics

Largest Supplier of Electrical and Electronic Components

*Click to view similar products for [D-Sub Standard Connectors](#) category:*

*Click to view products by [ITT](#) manufacturer:*

Other Similar products are found below :

[DCM37S732N](#) [DAM15P500](#) [DEV09S364GTLF](#) [DEM09P032N](#) [DDM50P732N](#) [DAM15S332N](#) [173109-2218](#) [173109-2466](#) [173109-2436](#)  
[173109-2435](#) [56F706-005-LI](#) [56F711-015](#) [015-0341-000](#) [015-0372-008](#) [015-8544-011](#) [017041-0005](#) [020419-0104](#) [012-0515-000](#) [012-9507-](#)  
[034](#) [012-9507-114](#) [012-9534-001](#) [020745-0008](#) [609-25P](#) [M24308/2-23Z](#) [M243082310F](#) [M243082410F](#) [M243082411F](#) [M24308/4-21](#)  
[CT1A18-11PSA206](#) [CT1N36-5SC](#) [CT2-16S-17PS](#) [CT2-20-15PCAU](#) [CT2-24-12PS](#) [CT2-24-28PSF127A206](#) [CT2-32-9PC](#) [CT6F9767-14-4-](#)  
[14S-5PC](#) [CT6FA10SL-4PS](#) [CT7-18-10SC](#) [CT7-18-10SCAU](#) [CT7-18-12SCAU](#) [CT7-18-1PC](#) [CT7-18-1PCAU](#) [CT7-18-21SCAU](#) [M83513/01-](#)  
[FC](#) [M83723/76W24619 L/C](#) [M85049/48-3-2F](#) [69001-865](#) [6STD09PCM99B70X](#) [6STD09SCM99B30X](#) [6STD09SCT99S40X](#)