



SAURO[®]
ELECTRONIC CONNECTORS
by the law

CSF

Terminal Blocks

Components features

- M3 nickel plated copper alloy screw.
- Nickel-plated copper alloy rising clamp.
- Polyamide housing.
Standard colour: GREEN.
V0 self-extinguishing according to UL 94.
Chlorinated solvents resistant,
with no phosphor, dioxin or
detrimental to health halogens.
- Leadfree tin-plated copper alloy spring.
- Easy to solder lead-free
tin-plated copper alloy pin.

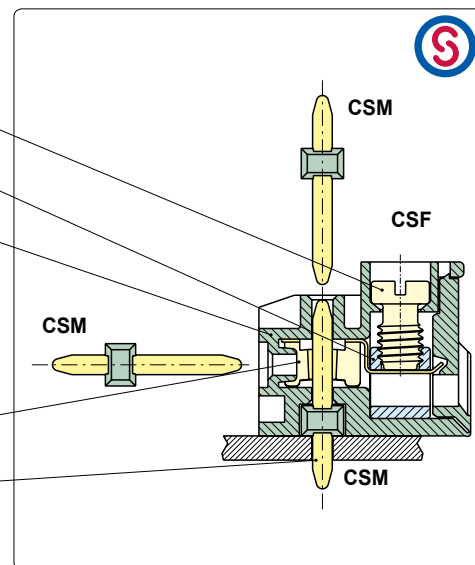

Mechanical features

Insertion force per pole	max 2 N (max .450 lbf)
Withdrawal force per pole	min 1,2 N (min .270 lbf)
Recommended/highest tightening torque	0.5/0.6 Nm (4.42/5.30 lbf-in)
PCB thickness	max 2.4 mm (.094 in)
PCB hole diameter	min 1.4 mm (.055 in)
Stripping length	4 ÷ 6 mm (.16 ÷ .24 in)
Operating temperature range	-40 °C ÷ +110 °C (-40 °F ÷ +230 °F)
Climatic category	40/110/21 According to EN 60068-1

Electrical features*

Solid wire section	0.05 mm ² ÷ 2,5 mm ² (IMQ)* 30÷14 AWG (UL)*
Stranded wire section	0.05 mm ² ÷ 2,5 mm ² (IMQ)* 30÷14 AWG (UL)*
Rated voltage for 5 mm (.197 in) pitch	300 V (IMQ)*
Rated voltage for 10 mm (.394 in) pitch	1000 V (IMQ)*
Rated current	12 A (VDE)*
Contact resistance	<15 mΩ
Insulation resistance	>10 ⁹ Ω (500V DC)

*All the a.m. data refer to the highest values amongst the certified ones.
V voltage, I current values and tightening torque are related to the norms to be applied to the product and to its use.

Approvals

IEC-EN	IEC:	for 5 mm pitch:	200 V - 11 A - 2.5 mm ² - T110 - 4kV - III/3 / 300 V - 11 A - 2.5 mm ² - T110 - 4kV - II/2
	EN 61984	for 10 mm pitch:	630 V - 11 A - 2.5 mm ² - T110 - 8kV - III/3 / 1000 V - 11 A - 2.5 mm ² - T110 - 8kV - II/2
UL	UL:	300 V - 12 A - 30÷14 AWG - 6 lbf-in for 5 mm pitch (10A for "9", "0", "J", "S" and "F" versions)	
	File E167473	600 V - 12 A - 30÷14 AWG - 6 lbf-in for 10 mm pitch (10A for "9", "0", "J", "S" and "F" versions)	
	Application values for end-use equipment have to be in accordance to UL norms and applicable to it.		
VDE	VDE:	for 5 mm pitch:	250 V - 12 A - 1.5 mm ² - T90 - 2,5kV - 2 (10A - T95 for "9", "0", "J", "S" and "F" versions)
	File n. 40013401	for 10 mm pitch:	750 V - 12 A - 1.5 mm ² - T90 - 2,5kV - 2 (10A - T95 for "9", "0", "J", "S" and "F" versions)
IMQ	IMQ:	for 5 mm pitch:	250 V - 11 A - 2.5 mm ² - T110 - 4kV - III/3 / 300 V - 11 A - 2.5 mm ² - T110 - 4kV - II/2
	File n. EE099	for 10 mm pitch:	630 V - 11 A - 2.5 mm ² - T110 - 8kV - III/3 / 1000 V - 11 A - 2.5 mm ² - T110 - 8kV - II/2
CSA	CSA:	300 V - 12 A - 30÷14 AWG for 5 mm pitch (10A for "9" and "0" versions)	
	File LR102896	600 V - 12 A - 30÷14 AWG for 10 mm pitch (10A for "9" and "0" versions)	

See also "Certifications", page 8

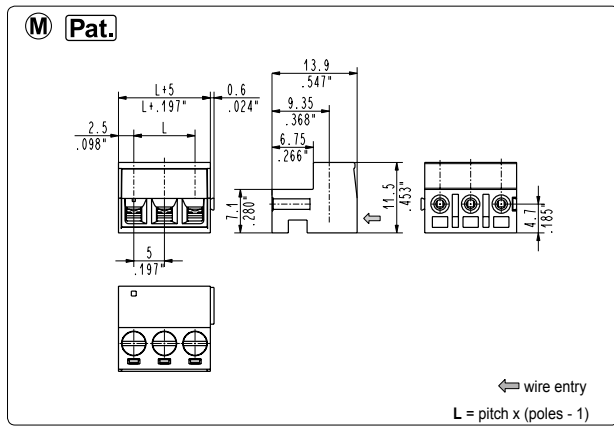

CSF_0M1 straight, modular female

5 mm / .197" pitch

Poles	Code	Pcs/pack.	W [kg]*	Pcs/Ind.**	W [kg]*
02	CSF020M1	450	1,08	2500	6,00
03	CSF030M1	300	1,08	1750	6,30
04	CSF040M1	225	1,08	1500	7,20
05	CSF050M1	175	1,05	1000	6,00
06	CSF060M1	150	1,08	750	5,40
07	CSF070M1	125	1,05	750	6,30
08	CSF080M1	100	0,96	500	4,80
09	CSF090M1	100	1,08	500	5,40
10	CSF100M1	75	0,90	500	6,00
11	CSF110M1	75	0,99	500	6,60
12	CSF120M1	75	1,08	500	7,20
13	CSF130M1	50	0,78	500	7,80
14	CSF140M1	50	0,84	250	4,20
15	CSF150M1	50	0,90	250	4,50
16	CSF160M1	50	0,96	250	4,80
17	CSF170M1	50	1,02	250	5,10
18	CSF180M1	50	1,08	250	5,40
19	CSF190M1	50	1,14	250	5,70
20	CSF200M1	50	1,20	250	6,00
21	CSF210M1	50	1,26	250	6,30
22	CSF220M1	50	1,32	250	6,60
23	CSF230M1	50	1,38	250	6,90
24	CSF240M1	50	1,44	250	7,20
25	CSF250M1	50	1,50	250	7,50

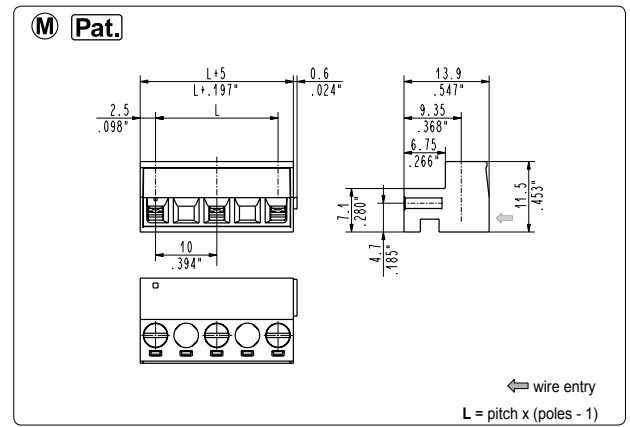

CSF_0M2 straight, modular female

10 mm / .394" pitch

Poles	Code	Pcs/pack.	W [kg]*	Pcs/Ind.**	W [kg]*
01	CSF010M2	450	0,68	2500	3,80
02	CSF020M2	300	0,91	1750	5,32
03	CSF030M2	175	0,80	1000	4,56
04	CSF040M2	125	0,76	750	4,56
05	CSF050M2	100	0,76	500	3,80
06	CSF060M2	75	0,68	500	4,56
07	CSF070M2	50	0,53	250	2,66
08	CSF080M2	50	0,61	250	3,04
09	CSF090M2	50	0,68	250	3,42
10	CSF100M2	50	0,76	250	3,80
11	CSF110M2	50	0,84	250	4,18
12	CSF120M2	50	0,91	250	4,56
13	CSF130M2	50	0,99	250	4,94

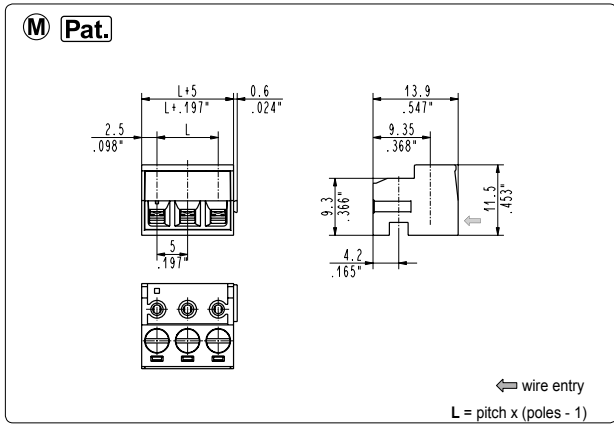

CSF_0W1 90°-270°, modular female

5 mm / .197" pitch

Poles	Code	Pcs/pack.	W [kg]*	Pcs/Ind.**	W [kg]*
02	CSF020W1	450	1,08	2500	6,00
03	CSF030W1	300	1,08	1750	6,30
04	CSF040W1	225	1,08	1500	7,20
05	CSF050W1	175	1,05	1000	6,00
06	CSF060W1	150	1,08	750	5,40
07	CSF070W1	125	1,05	750	6,30
08	CSF080W1	100	0,96	500	4,80
09	CSF090W1	100	1,08	500	5,40
10	CSF100W1	75	0,90	500	6,00
11	CSF110W1	75	0,99	500	6,60
12	CSF120W1	75	1,08	500	7,20
13	CSF130W1	50	0,78	500	7,80
14	CSF140W1	50	0,84	250	4,20
15	CSF150W1	50	0,90	250	4,50
16	CSF160W1	50	0,96	250	4,80
17	CSF170W1	50	1,02	250	5,10
18	CSF180W1	50	1,08	250	5,40
19	CSF190W1	50	1,14	250	5,70
20	CSF200W1	50	1,20	250	6,00
21	CSF210W1	50	1,26	250	6,30
22	CSF220W1	50	1,32	250	6,60
23	CSF230W1	50	1,38	250	6,90
24	CSF240W1	50	1,44	250	7,20
25	CSF250W1	50	1,50	250	7,50

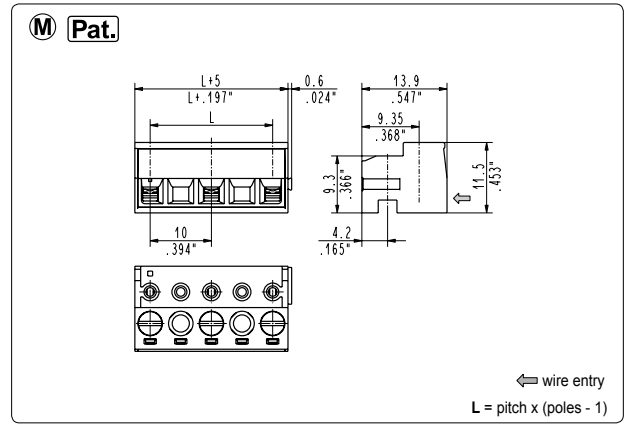

CSF_0W2 90°-270°, modular female

10 mm / .394" pitch

Poles	Code	Pcs/pack.	W [kg]*	Pcs/Ind.**	W [kg]*
01	CSF010W2	450	0,68	2500	3,80
02	CSF020W2	300	0,91	1750	5,32
03	CSF030W2	175	0,80	1000	4,56
04	CSF040W2	125	0,76	750	4,56
05	CSF050W2	100	0,76	500	3,80
06	CSF060W2	75	0,68	500	4,56
07	CSF070W2	50	0,53	250	2,66
08	CSF080W2	50	0,61	250	3,04
09	CSF090W2	50	0,68	250	3,42
10	CSF100W2	50	0,76	250	3,80
11	CSF110W2	50	0,84	250	4,18
12	CSF120W2	50	0,91	250	4,56
13	CSF130W2	50	0,99	250	4,94

*W [kg]: approximate weight per box in kg

**industrial packaging: add "-00000E" at standard code

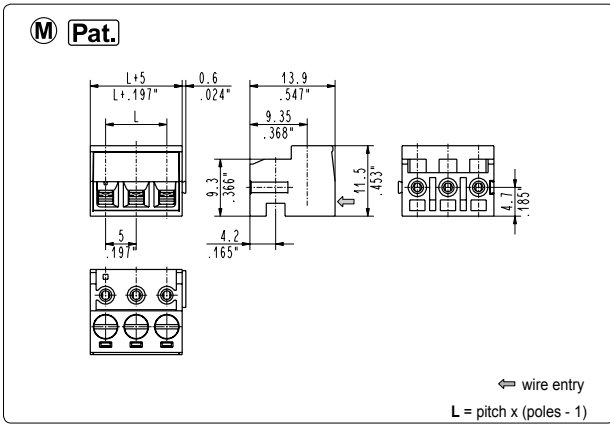

CSF_0U1 straight - 90° - 270°, modular female

5 mm / .197" pitch

Poles	Code	Pcs/pack.	W [kg]*	Pcs/Ind.**	W [kg]*
02	CSF020U1	450	1,08	2500	6,00
03	CSF030U1	300	1,08	1750	6,30
04	CSF040U1	225	1,08	1500	7,20
05	CSF050U1	175	1,05	1000	6,00
06	CSF060U1	150	1,08	750	5,40
07	CSF070U1	125	1,05	750	6,30
08	CSF080U1	100	0,96	500	4,80
09	CSF090U1	100	1,08	500	5,40
10	CSF100U1	75	0,90	500	6,00
11	CSF110U1	75	0,99	500	6,60
12	CSF120U1	75	1,08	500	7,20
13	CSF130U1	50	0,78	500	7,80
14	CSF140U1	50	0,84	250	4,20
15	CSF150U1	50	0,90	250	4,50
16	CSF160U1	50	0,96	250	4,80
17	CSF170U1	50	1,02	250	5,10
18	CSF180U1	50	1,08	250	5,40
19	CSF190U1	50	1,14	250	5,70
20	CSF200U1	50	1,20	250	6,00
21	CSF210U1	50	1,26	250	6,30
22	CSF220U1	50	1,32	250	6,60
23	CSF230U1	50	1,38	250	6,90
24	CSF240U1	50	1,44	250	7,20
25	CSF250U1	50	1,50	250	7,50

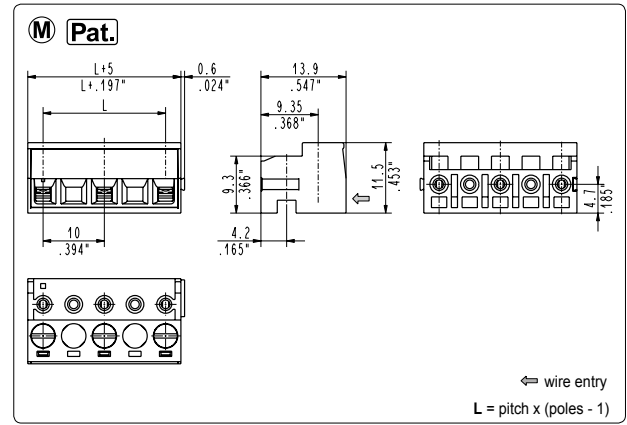

CSF_0U2 straight, modular female

10 mm / .394" pitch

Poles	Code	Pcs/pack.	W [kg]*	Pcs/Ind.**	W [kg]*
01	CSF010U2	300	0,68	2500	3,80
02	CSF020U2	300	0,91	1750	5,32
03	CSF030U2	175	0,80	1000	4,56
04	CSF040U2	125	0,76	750	4,56
05	CSF050U2	100	0,76	500	3,80
06	CSF060U2	75	0,68	500	4,56
07	CSF070U2	50	0,53	250	2,66
08	CSF080U2	50	0,61	250	3,04
09	CSF090U2	50	0,68	250	3,42
10	CSF100U2	50	0,76	250	3,80
11	CSF110U2	50	0,84	250	4,18
12	CSF120U2	50	0,91	250	4,56
13	CSF130U2	50	0,99	250	4,94

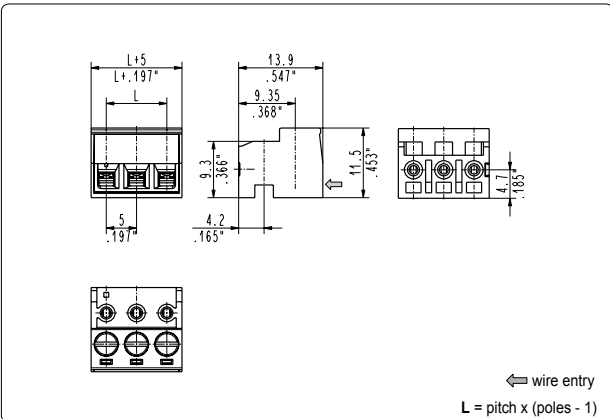

CSF_001 straight - 90° - 270°, side stackable female

5 mm / .197" pitch

Poles	Code	Pcs/pack.	W [kg]*	Pcs/Ind.**	W [kg]*
02	CSF02001	450	1,09	2500	6,05
03	CSF03001	300	1,09	1750	6,35
04	CSF04001	225	1,09	1500	7,26
05	CSF05001	175	1,06	1000	6,05
06	CSF06001	150	1,09	750	5,45
07	CSF07001	125	1,06	750	6,35
08	CSF08001	100	0,97	500	4,84
09	CSF09001	100	1,09	500	5,45
10	CSF10001	75	0,91	500	6,05
11	CSF11001	75	1,00	500	6,66
12	CSF12001	75	1,09	500	7,26
13	CSF13001	50	0,79	500	7,87
14	CSF14001	50	0,85	250	4,24
15	CSF15001	50	0,91	250	4,54
16	CSF16001	50	0,97	250	4,84
17	CSF17001	50	1,03	250	5,14
18	CSF18001	50	1,09	250	5,45
19	CSF19001	50	1,15	250	5,75
20	CSF20001	50	1,21	250	6,05
21	CSF21001	50	1,27	250	6,35
22	CSF22001	50	1,33	250	6,66
23	CSF23001	50	1,39	250	6,96
24	CSF24001	50	1,45	250	7,26
25	CSF25001	50	1,51	250	7,56

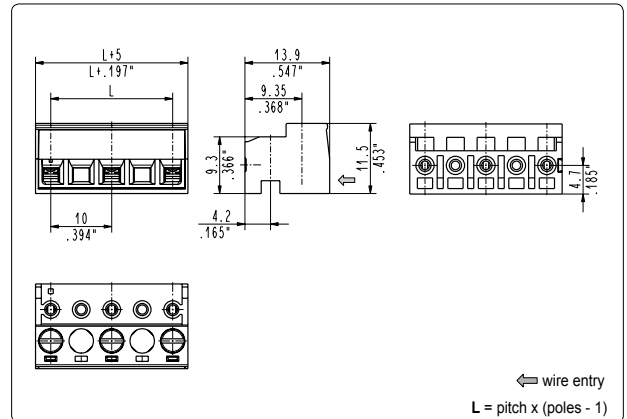

CSF_002 straight - 90° - 270°, female

10 mm / .394" pitch

Poles	Code	Pcs/pack.	W [kg]*	Pcs/Ind.**	W [kg]*
02	CSF02002	300	0,92	1750	5,36
03	CSF03002	175	0,80	1000	4,59
04	CSF04002	125	0,77	750	4,59
05	CSF05002	100	0,77	500	3,83
06	CSF06002	75	0,69	500	4,59
07	CSF07002	50	0,54	250	2,68
08	CSF08002	50	0,61	250	3,06
09	CSF09002	50	0,69	250	3,44
10	CSF10002	50	0,77	250	3,83
11	CSF11002	50	0,84	250	4,21
12	CSF12002	50	0,92	250	4,59
13	CSF13002	50	0,99	250	4,97

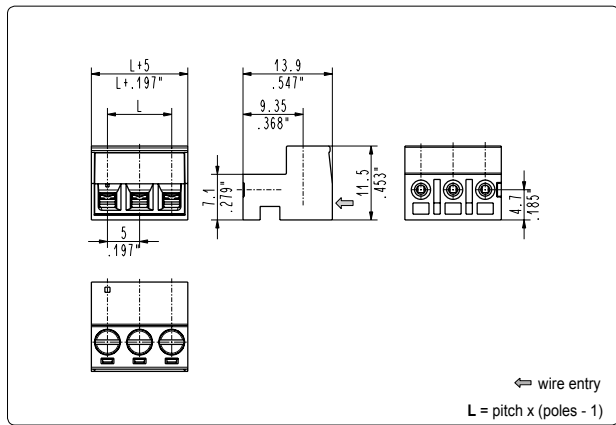

CSF_011 straight, female

5 mm / .197" pitch					
Poles	Code	Pcs/pack.	W [kg]*	Pcs/Ind.**	W [kg]*
02	CSF02011	450	1,09	2500	6,05
03	CSF03011	300	1,09	1750	6,35
04	CSF04011	225	1,09	1500	7,26
05	CSF05011	175	1,06	1000	6,05
06	CSF06011	150	1,09	750	5,45
07	CSF07011	125	1,06	750	6,35
08	CSF08011	100	0,97	500	4,84
09	CSF09011	100	1,09	500	5,45
10	CSF10011	75	0,91	500	6,05
11	CSF11011	75	1,00	500	6,66
12	CSF12011	75	1,09	500	7,26
13	CSF13011	50	0,79	500	7,87
14	CSF14011	50	0,85	250	4,24
15	CSF15011	50	0,91	250	4,54
16	CSF16011	50	0,97	250	4,84
17	CSF17011	50	1,03	250	5,14
18	CSF18011	50	1,09	250	5,45
19	CSF19011	50	1,15	250	5,75
20	CSF20011	50	1,21	250	6,05
21	CSF21011	50	1,27	250	6,35
22	CSF22011	50	1,33	250	6,66
23	CSF23011	50	1,39	250	6,96
24	CSF24011	50	1,45	250	7,26
25	CSF25011	50	1,51	250	7,56

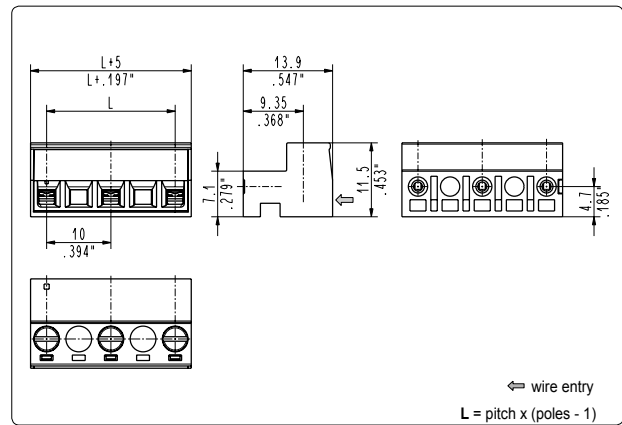

CSF_012 straight, female

10 mm / .394" pitch					
Poles	Code	Pcs/pack.	W [kg]*	Pcs/Ind.**	W [kg]*
02	CSF02012	300	0,92	1750	5,36
03	CSF03012	175	0,80	1000	4,59
04	CSF04012	125	0,77	750	4,59
05	CSF05012	100	0,77	500	3,83
06	CSF06012	75	0,69	500	4,59
07	CSF07012	50	0,54	250	2,68
08	CSF08012	50	0,61	250	3,06
09	CSF09012	50	0,69	250	3,44
10	CSF10012	50	0,77	250	3,83
11	CSF11012	50	0,84	250	4,21
12	CSF12012	50	0,92	250	4,59
13	CSF13012	50	0,99	250	4,97

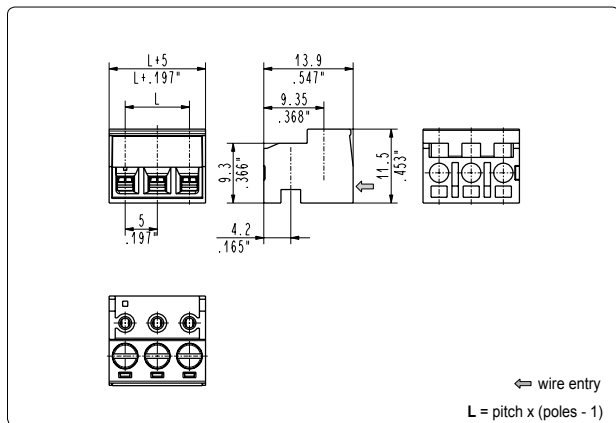

CSF_091 90° - 270°, female

5 mm / .197" pitch					
Poles	Code	Pcs/pack.	W [kg]*	Pcs/Ind.**	W [kg]*
02	CSF02091	450	1,09	2500	6,05
03	CSF03091	300	1,09	1750	6,35
04	CSF04091	225	1,09	1500	7,26
05	CSF05091	175	1,06	1000	6,05
06	CSF06091	150	1,09	750	5,45
07	CSF07091	125	1,06	750	6,35
08	CSF08091	100	0,97	500	4,84
09	CSF09091	100	1,09	500	5,45
10	CSF10091	75	0,91	500	6,05
11	CSF11091	75	1,00	500	6,66
12	CSF12091	75	1,09	500	7,26
13	CSF13091	50	0,79	500	7,87
14	CSF14091	50	0,85	250	4,24
15	CSF15091	50	0,91	250	4,54
16	CSF16091	50	0,97	250	4,84
17	CSF17091	50	1,03	250	5,14
18	CSF18091	50	1,09	250	5,45
19	CSF19091	50	1,15	250	5,75
20	CSF20091	50	1,21	250	6,05
21	CSF21091	50	1,27	250	6,35
22	CSF22091	50	1,33	250	6,66
23	CSF23091	50	1,39	250	6,96
24	CSF24091	50	1,45	250	7,26
25	CSF25091	50	1,51	250	7,56

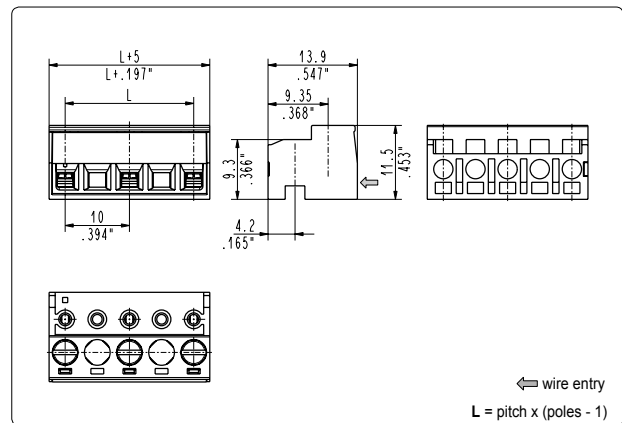

CSF_092 90° - 270°, female

10 mm / .394" pitch					
Poles	Code	Pcs/pack.	W [kg]*	Pcs/Ind.**	W [kg]*
02	CSF02092	300	0,92	1750	5,36
03	CSF03092	175	0,80	1000	4,59
04	CSF04092	125	0,77	750	4,59
05	CSF05092	100	0,77	500	3,83
06	CSF06092	75	0,69	500	4,59
07	CSF07092	50	0,54	250	2,68
08	CSF08092	50	0,61	250	3,06
09	CSF09092	50	0,69	250	3,44
10	CSF10092	50	0,77	250	3,83
11	CSF11092	50	0,84	250	4,21
12	CSF12092	50	0,92	250	4,59
13	CSF13092	50	0,99	250	4,97

*W [kg]: approximate weight per box in kg

**Industrial packaging: add "-00000E" at standard code

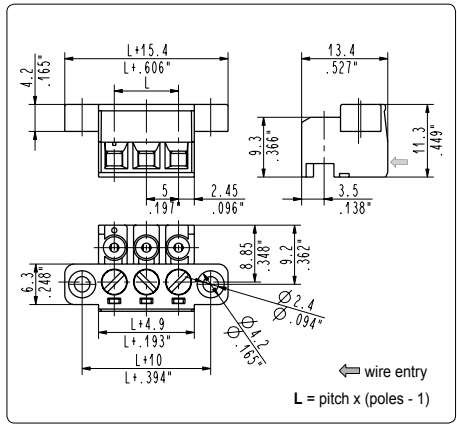
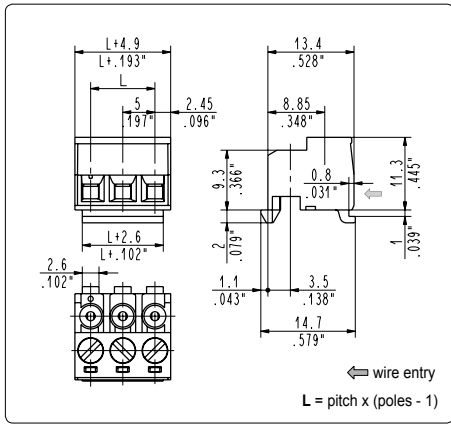
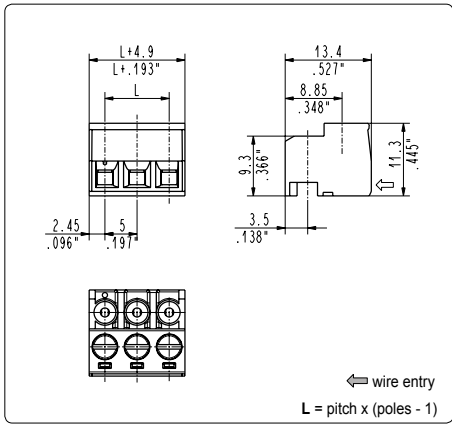

CSF_0J1 90°-270°, safe female

5 mm / .197" pitch

Poles	Code	Pcs/pack.	W [kg]*	Pcs/Ind.**	W [kg]*
02	CSF020J1	450	1,08	2500	6,00
03	CSF030J1	300	1,08	1750	6,30
04	CSF040J1	225	1,08	1500	7,20
05	CSF050J1	175	1,05	1000	6,00
06	CSF060J1	150	1,08	750	5,40
07	CSF070J1	125	1,05	750	6,30
08	CSF080J1	100	0,96	500	4,80
09	CSF090J1	100	1,08	500	5,40
10	CSF100J1	75	0,90	500	6,00
11	CSF110J1	75	0,99	500	6,60
12	CSF120J1	75	1,08	500	7,20
13	CSF130J1	50	0,78	500	7,80
14	CSF140J1	50	0,84	250	4,20
15	CSF150J1	50	0,90	250	4,50
16	CSF160J1	50	0,96	250	4,80
17	CSF170J1	50	1,02	250	5,10
18	CSF180J1	50	1,08	250	5,40
19	CSF190J1	50	1,14	250	5,70
20	CSF200J1	50	1,20	250	6,00
21	CSF210J1	50	1,26	250	6,30
22	CSF220J1	50	1,32	250	6,60
23	CSF230J1	50	1,38	250	6,90
24	CSF240J1	50	1,44	250	7,20
25	CSF250J1	50	1,50	250	7,50

CSF_0S1 90°-270°, female with snap features

5 mm / .197" pitch

Poles	Code	Pcs/pack.	W [kg]*	Pcs/Ind.**	W [kg]*
02	CSF020S1	450	1,01	2500	6,10
03	CSF030S1	300	1,01	1750	6,41
04	CSF040S1	225	1,01	1500	7,32
05	CSF050S1	175	1,07	1000	6,10
06	CSF060S1	150	1,01	750	5,49
07	CSF070S1	125	1,07	750	6,41
08	CSF080S1	100	0,98	500	4,88
09	CSF090S1	100	1,01	500	5,49
10	CSF100S1	75	0,92	500	6,10
11	CSF110S1	75	1,01	500	6,71
12	CSF120S1	75	1,01	500	7,32
13	CSF130S1	50	0,79	500	7,93
14	CSF140S1	50	0,85	250	4,27
15	CSF150S1	50	0,92	250	4,58
16	CSF160S1	50	0,98	250	4,88
17	CSF170S1	50	1,04	250	5,19
18	CSF180S1	50	1,01	250	5,49
19	CSF190S1	50	1,16	250	5,80
20	CSF200S1	50	1,22	250	6,10
21	CSF210S1	50	1,28	250	6,41
22	CSF220S1	50	1,34	250	6,71
23	CSF230S1	50	1,40	250	7,02
24	CSF240S1	50	1,46	250	7,32
25	CSF250S1	50	1,53	250	7,63

CSF_0F1 90°-270°, female with high flange

5 mm / .197" pitch

Poles	Code	Pcs/pack.	W [kg]*	Pcs/Ind.**	W [kg]*
02	CSF020F1	450	1,44	2500	4,00
03	CSF030F1	300	1,32	1750	4,40
04	CSF040F1	225	1,26	1500	5,60
05	CSF050F1	175	1,19	1000	5,10
06	CSF060F1	150	1,20	750	6,00
07	CSF070F1	125	1,15	750	4,60
08	CSF080F1	100	1,04	500	5,20
09	CSF090F1	100	1,16	500	5,80
10	CSF100F1	75	0,96	500	6,40
11	CSF110F1	75	1,05	500	7,00
12	CSF120F1	75	1,14	500	7,60
13	CSF130F1	50	0,82	250	4,10
14	CSF140F1	50	0,88	250	4,40
15	CSF150F1	50	0,94	250	4,70
16	CSF160F1	50	1,00	250	5,00
17	CSF170F1	50	1,06	250	5,30
18	CSF180F1	50	1,12	250	5,60
19	CSF190F1	50	1,18	250	5,90
20	CSF200F1	50	1,24	250	6,20
21	CSF210F1	50	1,30	250	6,50
22	CSF220F1	50	1,36	250	6,80
23	CSF230F1	50	1,42	250	7,10

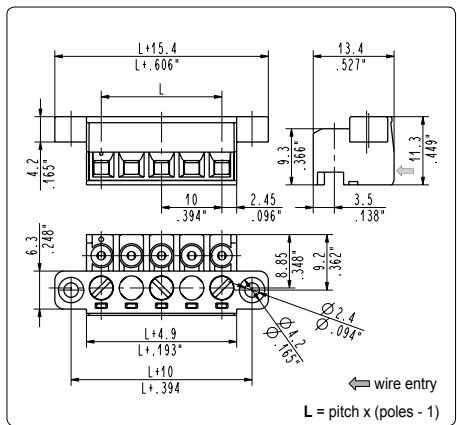
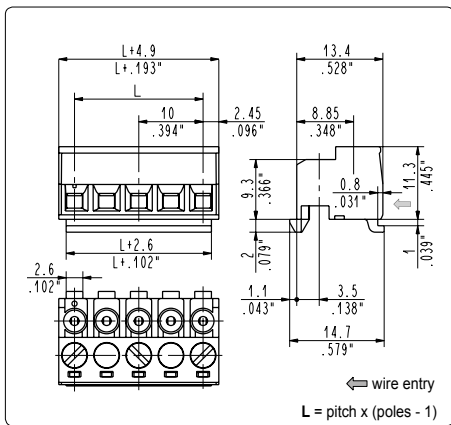
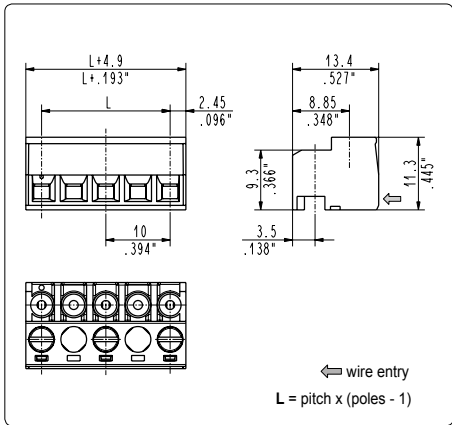

CSF_0J2 90°-270°, safe female

10 mm / .394" pitch

Poles	Code	Pcs/pack.	W [kg]*	Pcs/Ind.**	W [kg]*
02	CSF020J2	300	0,91	1750	5,32
03	CSF030J2	175	0,80	1000	4,56
04	CSF040J2	125	0,76	750	4,56
05	CSF050J2	100	0,76	500	3,80
06	CSF060J2	75	0,68	500	4,56
07	CSF070J2	50	0,53	250	2,66
08	CSF080J2	50	0,61	250	3,04
09	CSF090J2	50	0,68	250	3,42
10	CSF100J2	50	0,76	250	3,80
11	CSF110J2	50	0,84	250	4,18
12	CSF120J2	50	0,91	250	4,56
13	CSF130J2	50	0,99	250	4,94

CSF_0S2 90°-270°, female with snap features

10 mm / .394" pitch

Poles	Code	Pcs/pack.	W [kg]*	Pcs/Ind.**	W [kg]*
02	CSF020S2	300	0,94	1750	5,50
03	CSF030S2	175	0,82	1000	4,71
04	CSF040S2	125	0,79	750	4,71
05	CSF050S2	100	0,79	500	3,93
06	CSF060S2	75	0,71	500	4,71
07	CSF070S2	50	0,55	250	2,75
08	CSF080S2	50	0,63	250	3,14
09	CSF090S2	50	0,71	250	3,53
10	CSF100S2	50	0,79	250	3,93
11	CSF110S2	50	0,86	250	4,32
12	CSF120S2	50	0,94	250	4,71
13	CSF130S2	50	1,02	250	5,10

CSF_0F2 90°-270°, female with high flange

10 mm / .394" pitch

Poles	Code	Pcs/pack.	W [kg]*	Pcs/Ind.**	W [kg]*
02	CSF020F2	300	1,15	1750	6,72
03	CSF030F2	175	0,94	1000	5,36
04	CSF040F2	125	0,86	750	5,16
05	CSF050F2	100	0,84	500	4,20
06	CSF060F2	75	0,74	500	4,96
07	CSF070F2	50	0,57	250	2,86
08	CSF080F2	50	0,65	250	3,24
09	CSF090F2	50	0,72	250	3,62
10	CSF100F2	50	0,80	250	4,00
11	CSF110F2	50	0,88	250	4,38
12	CSF120F2	50	0,95	250	4,76

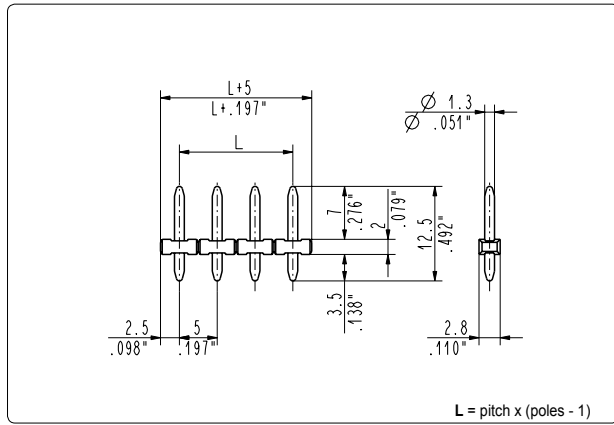

CSM_0A1 straight, side stackable male

5 mm / .197" pitch

Poles	Code	Pcs/pack.	W [kg]*	Pcs/Ind.**	W [kg]*
02	CSM020A1	450	0,15	2500	0,85
03	CSM030A1	300	0,15	1750	0,89
04	CSM040A1	225	0,15	1500	1,02
05	CSM050A1	175	0,15	1000	0,85
06	CSM060A1	150	0,15	1500	1,53
07	CSM070A1	125	0,15	750	0,89
08	CSM080A1	100	0,14	500	0,68
09	CSM090A1	100	0,15	500	0,77
10	CSM100A1	75	0,13	500	0,85
11	CSM110A1	75	0,14	500	0,94
12	CSM120A1	75	0,15	500	1,02
13	CSM130A1	50	0,11	250	0,55
14	CSM140A1	50	0,12	250	0,60
15	CSM150A1	50	0,13	250	0,64
16	CSM160A1	50	0,14	250	0,68
17	CSM170A1	50	0,14	250	0,72
18	CSM180A1	50	0,15	250	0,77
19	CSM190A1	50	0,16	250	0,81
20	CSM200A1	50	0,17	250	0,85
21	CSM210A1	50	0,18	250	0,89
22	CSM220A1	50	0,19	250	0,94
23	CSM230A1	50	0,20	250	0,98
24	CSM240A1	50	0,20	250	1,02
25	CSM250A1	50	0,21	500	2,13

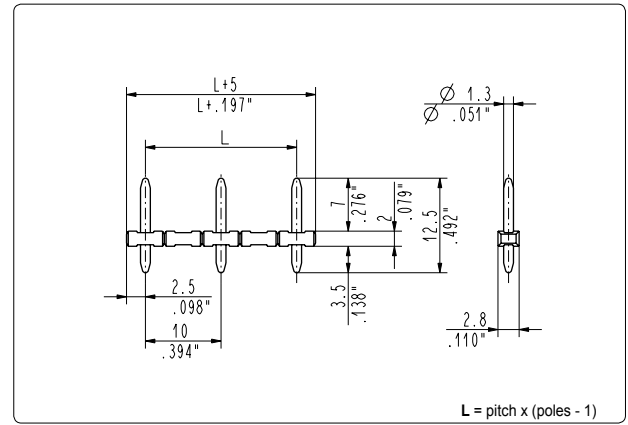

CSM_0A2 straight, side stackable male

10 mm / .394" pitch

Poles	Code	Pcs/pack.	W [kg]*	Pcs/Ind.**	W [kg]*
02	CSM020A2	300	0,11	1750	0,63
03	CSM030A2	175	0,09	1000	0,54
04	CSM040A2	125	0,09	750	0,54
05	CSM050A2	100	0,09	500	0,45
06	CSM060A2	75	0,08	500	0,54
07	CSM070A2	50	0,06	250	0,32
08	CSM080A2	50	0,07	250	0,36
09	CSM090A2	50	0,08	250	0,41
10	CSM100A2	50	0,09	250	0,45
11	CSM110A2	50	0,01	250	0,50
12	CSM120A2	50	0,11	250	0,54
13	CSM130A2	50	0,12	250	0,59

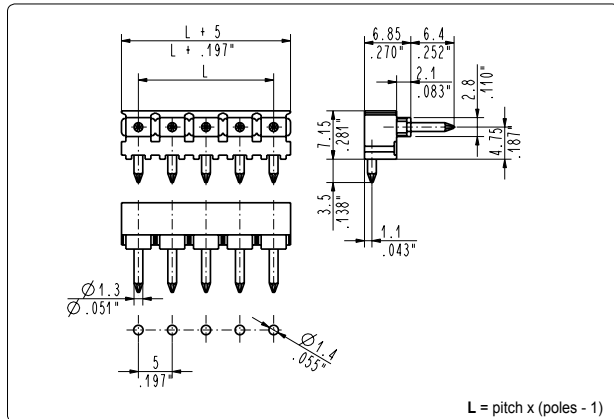

CSM_9A1 90°, side stackable male

5 mm / .197" pitch

Poles	Code	Pcs/pack.	W [kg]*	Pcs/Ind.**	W [kg]*
02	CSM029A1	450	0,36	2500	2,00
03	CSM039A1	300	0,36	1750	2,10
04	CSM049A1	225	0,36	1500	2,40
05	CSM059A1	175	0,36	1000	2,00
06	CSM069A1	150	0,36	1500	3,60
07	CSM079A1	125	0,36	750	2,10
08	CSM089A1	100	0,32	500	1,60
09	CSM099A1	100	0,36	500	1,80
10	CSM109A1	75	0,30	500	2,00
11	CSM119A1	75	0,34	500	2,20
12	CSM129A1	75	0,36	500	2,40
13	CSM139A1	50	0,26	250	1,30
14	CSM149A1	50	0,28	250	1,40
15	CSM159A1	50	0,30	250	1,50
16	CSM169A1	50	0,32	250	1,60
17	CSM179A1	50	0,34	250	1,70
18	CSM189A1	50	0,36	250	1,80
19	CSM199A1	50	0,38	250	1,90
20	CSM209A1	50	0,40	250	2,00
21	CSM219A1	50	0,42	250	2,10
22	CSM229A1	50	0,44	250	2,20
23	CSM239A1	50	0,46	250	2,30
24	CSM249A1	50	0,48	250	2,40
25	CSM259A1	50	0,50	500	5,00

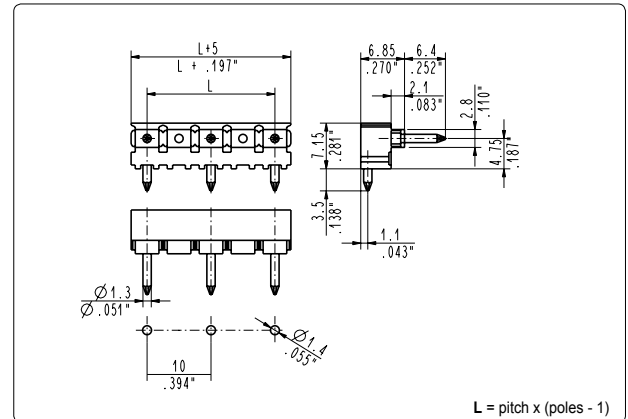

CSM_9A2 90°, side stackable male

10 mm / .394" pitch

Poles	Code	Pcs/pack.	W [kg]*	Pcs/Ind.**	W [kg]*
02	CSM029A2	300	0,30	1750	1,70
03	CSM039A2	175	0,25	1000	1,44
04	CSM049A2	125	0,25	750	1,44
05	CSM059A2	100	0,25	500	1,21
06	CSM069A2	75	0,20	500	1,44
07	CSM079A2	50	0,16	250	0,85
08	CSM089A2	50	0,18	250	0,97
09	CSM099A2	50	0,21	250	1,08
10	CSM109A2	50	0,25	250	1,21
11	CSM119A2	50	0,27	250	1,33
12	CSM129A2	50	0,30	250	1,44
13	CSM139A2	50	0,32	250	1,56

*W [kg]: approximate weight per box in kg

**industrial packaging: add "-00000E" at standard code

X-ON Electronics

Largest Supplier of Electrical and Electronic Components

Click to view similar products for [Pluggable Terminal Blocks](#) category:

Click to view products by [Sauro](#) manufacturer:

Other Similar products are found below :

[57.404.7553](#) [57.504.0053.7](#) [57.510.0053](#) [57.910.6153](#) [01.112.1453](#) [CTB932VE/6](#) [MC 1.5/ 6-ST-3.5 GY AU](#) [ET02015000J0G](#) [734-104](#) [734-302](#) [734-304](#) [8-141-P](#) [FKCT 2.5/ 3-ST KMGY](#) [860505](#) [860508](#) [860516](#) [860810](#) [861908](#) [GBPACX-12](#) [93.731.4953.0](#) [PV05-5,08-K](#) [PVP02-5,00](#) [PVP04-3,50](#) [PVS02-5,00](#) [1-1986160-3](#) [H-10](#) [1546228-5](#) [ELFH09150](#) [ELFH16150](#) [ELFP03110](#) [ELFT06250](#) [ELFT07250](#) [ELVF09400](#) [ELVP03100](#) [ELXH03100](#) [ELXP041G0](#) [ELXT046G0](#) [1700101](#) [1700410](#) [1700425](#) [1703176](#) [1703243](#) [1705229](#) [1710175](#) [1714537](#) [1717806](#) [1719600](#) [1728941](#) [1729386](#) [1734692](#)