

FEATURES

- STACKED METALLIZED POLYPHENYLENE SULFIDE (PPS) FILM
- STANDARD EIA 0603, 0805, 1206, 1210, 1913 AND 2416 SIZES
- WIDE TEMPERATURE RANGE UP TO +125°C (100pF ~ 0.1μF)
- HIGH HEAT AND MOISTURE RESISTANT
- VERY STABLE TEMPERATURE, FREQUENCY AND VOLTAGE BIAS CHARACTERISTICS
- SUITABLE FOR REFLOW SOLDERING
- TAPE AND REEL PACKAGING

**NSHC IS
RECOMMENDED
FOR NEW DESIGNS**



**RoHS
Compliant**
includes all homogeneous materials

*See Part Number System for Details

SPECIFICATIONS	Case Sizes					
	0603	0805	1206	1210	1913	2416
Capacitance Range	100pF ~ 0.0027μF	100pF ~ .01μF	3300pF ~ .047μF	.012μF ~ .1μF	.047μF ~ .1μF	.12μF ~ .22μF
Voltage Ratings	16Vdc (12Vrms), 50Vdc (40Vrms)					
Capacitance Tolerance	±5% Std, ±2% Opt.					
Temperature Range	-55°C ~ +125°C (0.12μF ~ 0.22μF voltage derated above +105°C)					
Dissipation Factor (20°C)	0.6% max. @ 1KHz					
Insulation Resistance (20°C)	3 Gigohms Minimum					
Dielectric Withstanding Voltage	150% of Rated Voltage 60 Seconds or 175% of Rated Voltage for 5 Seconds (except 1913 and 2416 case sizes)					
Temperature Characteristic	±3% ΔC Maximum Over Temperature Range					

ENVIRONMENTAL CHARACTERISTICS

Life Test At +125°C 1,000 Hours at 125% of Rated Voltage	Capacitance Change	Within ±2% of Initial Value
	Dissipation Factor	0.68% Maximum
	Insulation Resistance	1 Gigohm Minimum
Resistance to Soldering Heat +260°C Peak	Capacitance Change	Within ±3% of Initial Value
	Dissipation Factor	0.66% Maximum
	Insulation Resistance	1 Gigohm Minimum
Humidity Load Life: (1) 1000 Hours, +40°C (2) 500 Hours, +60°C (3) 500 Hours +85°C/85% RH	Capacitance Change	(1) & (2) Within ±2% of Initial value (3) Within ±10% of initial value
	Dissipation Factor	(1) & (2) 0.90% Maximum (3) 1.2% maximum
	Insulation Resistance	(1) 1 Gigohm Minimum (2) 0.5 Gigohm Minimum (3) 0.01 Gigohm min.
Solderability with 25% Wt Rosin-Methanol Flux	90% Minimum Coverage After 2.5 Second Dip into 255°C Solder Pot	

RECOMMENDED REFLOW PROFILE (maximum 2 times)

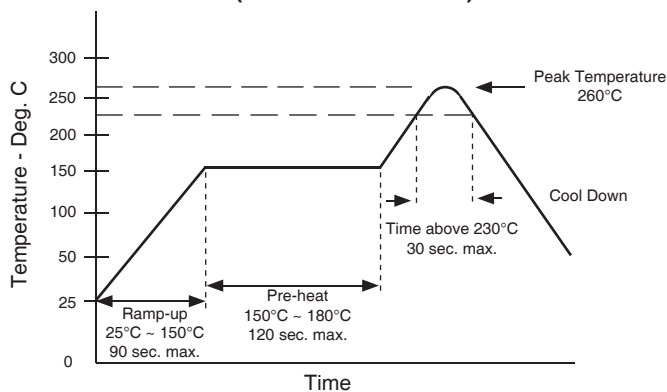

Solder within 1 year. Storage at +30°C and 60% RH

RECOMMENDED LAND PATTERN (mm)

Case Code	EIA Size	A	B	C
J1	0603	0.6	2.0	0.7
A1, A2	0805	0.8	2.4	1.1
B1, B2, B3	1206	1.8	3.6	1.4
C2, C3	1210	1.8	3.6	2.3
D5, D6	1913	3.0	5.6	3.0
E6, E7, E8	2416	4.0	7.0	3.8

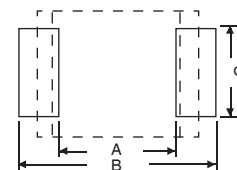

Stacked Film Capacitor Chips

NSHC Series

16V STANDARD PRODUCTS AND CASE SIZES

Part Number	Cap. Value	Cap. Code	Size Code	Length L ± 0.2	Width W	Height H ± 0.2	p	EIA
NSHC101J16TRJ1F	100pF	101	J1	1.6	0.8 ± 0.15	0.7 ± 0.15	0.35 ± 0.20	0603
NSHC121J16TRJ1F	120	121	J1					
NSHC151J16TRJ1F	150	151	J1					
NSHC181J16TRJ1F	180	181	J1					
NSHC221J16TRJ1F	220	221	J1					
NSHC271J16TRJ1F	270	271	J1					
NSHC331J16TRJ1F	330	331	J1					
NSHC391J16TRJ1F	390	391	J1					
NSHC471J16TRJ1F	470	471	J1					
NSHC561J16TRJ1F	560	561	J1					
NSHC681J16TRJ1F	680	681	J1					
NSHC821J16TRJ1F	820	821	J1					
NSHC102J16TRJ1F	0.001	102	J1					
NSHC122J16TRJ1F	0.0012	122	J1					
NSHC152J16TRJ1F	0.0015	152	J1					
NSHC182J16TRJ1F	0.0018	182	J1					
NSHC222J16TRJ1F	0.0022	222	J1					
NSHC272J16TRJ1F	0.0027	272	J1					
NSHC332J16TRA1F	0.0033	332	A1	2.0	1.25 ± 0.2	0.9	0.45 ± 0.25	0805
NSHC392J16TRA1F	0.0039	392	A1					
NSHC472J16TRA1F	0.0047	472	A1					
NSHC562J16TRA1F	0.0056	562	A1					
NSHC682J16TRA1F	0.0068	682	A1					
NSHC822J16TRA2F	0.0082	822	A2					
NSHC103J16TRA2F	0.010	103	A2					
NSHC123J16TRB1F	0.012	123	B1					
NSHC153J16TRB1F	0.015	153	B1	3.2	1.6 ± 0.2	0.9	0.65 ± 0.35	1206
NSHC183J16TRB1F	0.018	183	B1					
NSHC223J16TRB1F	0.022	223	B1					
NSHC273J16TRB2F	0.027	273	B2					
NSHC333J16TRB2F	0.033	333	B2					
NSHC393J16TRB3F	0.039	393	B3					
NSHC473J16TRB3F	0.047	473	B3					
NSHC563J16TRC2F	0.056	563	C2					
NSHC683J16TRC2F	0.068	683	C2	3.2	2.5 ± 0.2	1.5	0.65 ± 0.35	1210
NSHC823J16TRC3F	0.082	823	C3					
NSHC104J16TRC3F	0.10	104	C3					

OUTLINE DRAWING

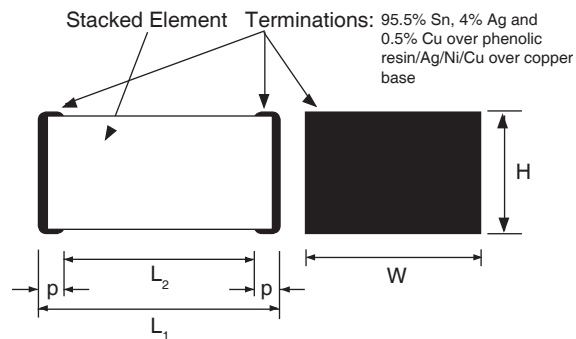

Stacked Film Capacitor Chips

NSHC Series

50V STANDARD PRODUCTS AND CASE SIZES

Part Number	Cap. Value	Cap. Code	Size Code	Length L ± 0.2	Width W	Height H ± 0.2	p	EIA	
NSHC101J50TRA1F	100pF	101	A1	2.0	1.25 ± 0.2	0.9	0.45 ± 0.25	0805	
NSHC121J50TRA1F	120	121	A1						
NSHC151J50TRA1F	150	151	A1						
NSHC181J50TRA1F	180	181	A1						
NSHC221J50TRA1F	220	221	A1						
NSHC271J50TRA1F	270	271	A1						
NSHC331J50TRA1F	330	331	A1						
NSHC391J50TRA1F	390	391	A1						
NSHC471J50TRA1F	470	471	A1						
NSHC561J50TRA1F	560	561	A1						
NSHC681J50TRA1F	680	681	A1						
NSHC821J50TRA1F	820	821	A1						
NSHC102J50TRA1F	0.001	102	A1						
NSHC122J50TRA1F	0.0012	122	A1						
NSHC152J50TRA1F	0.0015	152	A1						
NSHC182J50TRA1F	0.0018	182	A1						
NSHC222J50TRA1F	0.0022	222	A1						
NSHC272J50TRA1F	0.0027	272	A1						
NSHC332J50TRB1F	0.0033	332	B1	3.2	1.6 ± 0.2	0.9	0.65 ± 0.35	1206	
NSHC392J50TRB1F	0.0039	392	B1						
NSHC472J50TRB1F	0.0047	472	B1						
NSHC562J50TRB1F	0.0056	562	B1						
NSHC682J50TRB1F	0.0068	682	B1						
NSHC822J50TRB2F	0.0082	822	B2			1.1			
NSHC103J50TRB2F	0.010	103	B2						
NSHC123J50TRC1F	0.012	123	C1						1.1
NSHC153J50TRC1F	0.015	153	C1						
NSHC183J50TRC2F	0.018	183	C2						
NSHC223J50TRC2F	0.022	223	C2						
NSHC273J50TRC2F	0.027	273	C2						
NSHC333J50TRC3F	0.033	333	C3	2.1					
NSHC393J50TRC3F	0.039	393	C3						
NSHC473J50TRD5F	0.047	473	D5		1.5				
NSHC563J50TRD5F	0.056	563	D5						
NSHC683J50TRD5F	0.068	683	D5						
NSHC823J50TRD6F	0.082	823	D6	2.1					
NSHC104J50TRD6F	0.10	104	D6						
NSHC124J50TRE6F	0.12	124	E6		1.9				
NSHC154J50TRE6F	0.15	154	E6						
NSHC184J50TRE7F	0.18	184	E7			0.80 ± 0.30	2416		
NSHC224J50TRE8F	0.22	224	E8						

OUTLINE DRAWING

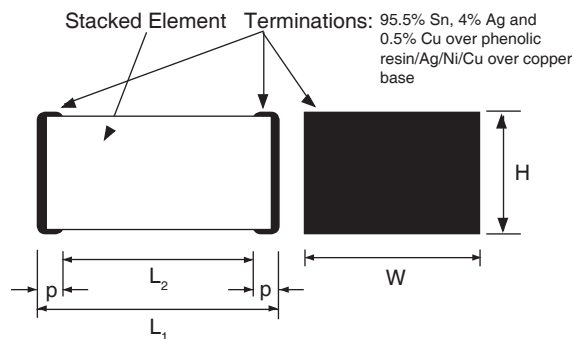

Stacked Film Capacitor Chips

NSHC Series

TAPE AND REEL DIMENSIONS (mm)

Case Code	A±0.1	B±0.1	C±0.2	t ± 0.05	W±0.3	F ± 0.05	P±0.1	D+0.2/-0	E ± 2.0	Qty/Reel
J1	1.00	1.85	1.0	0.20	8.0	3.50	4.0	-	180	4,000
A1	1.55	2.3	1.3	0.25	8.0	3.50	4.0	1.0	180	3,000
A2	1.55	2.3	1.3	0.25	8.0	3.50	4.0	1.0	180	3,000
B1	1.9	3.5	1.5	0.25	8.0	3.50	4.0	1.0	180	3,000
B2	1.9	3.5	1.5	0.25	8.0	3.50	4.0	1.0	180	3,000
B3	1.9	3.5	1.9	0.25	8.0	3.50	4.0	1.0	180	2,000
C2	2.8	3.5	1.9	0.25	8.0	3.50	4.0	1.0	180	2,000
C3	2.8	3.5	2.5	0.25	8.0	3.50	4.0	1.0	180	2,000
D5	3.8	5.1	2.0	0.30	12.0	5.50	8.0	1.5	330	3,000
D6	3.8	5.1	2.6	0.30	12.0	5.50	8.0	1.5	330	3,000
E6	4.6	6.3	2.7	0.30	12.0	5.50	8.0	-	330	3,000
E7	4.6	6.3	3.5	0.30	12.0	5.50	8.0	-	330	2,000
E8	4.6	6.3	3.5	0.30	12.0	5.50	8.0	-	330	2,000

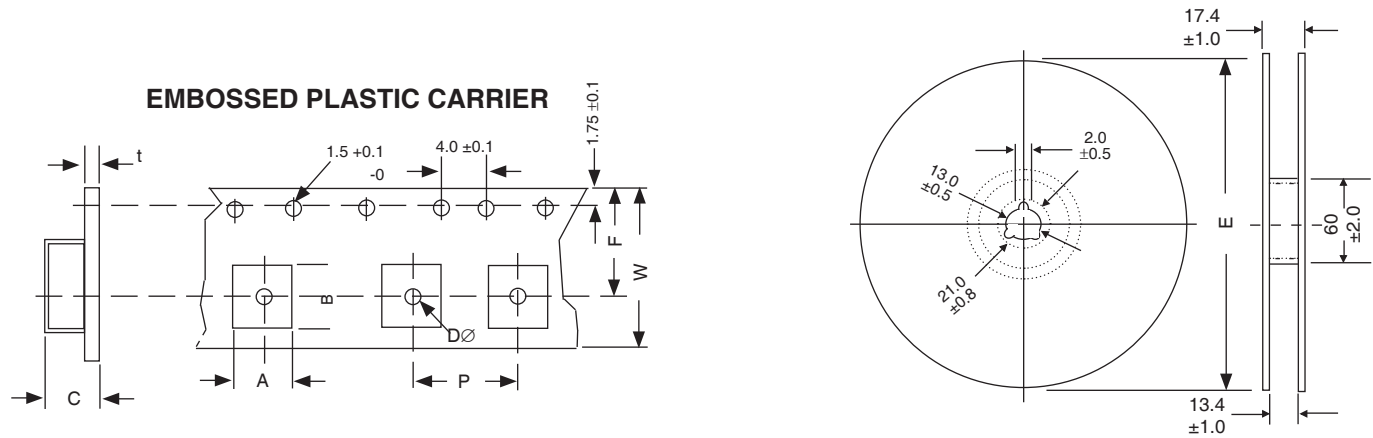

PART NUMBER SYSTEM

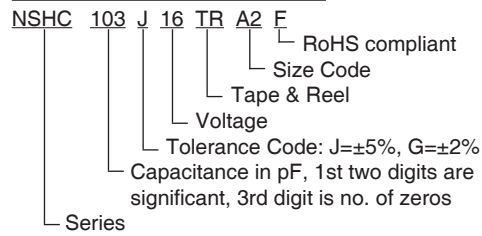

Stacked Film Capacitor Chips

NSHC 100V Series

FEATURES

- STACKED METALLIZED POLYPHENYLENE SULFIDE (PPS) FILM
- STANDARD EIA 1913, 2416, 2820 AND 2825 SIZES
- WIDE TEMPERATURE RANGE UP TO +105°C
- HIGH HEAT AND MOISTURE RESISTANT
- VERY STABLE TEMPERATURE, FREQUENCY, VOLTAGE, BIAS AND DIELECTRIC ABSORPTION CHARACTERISTICS
- SUITABLE FOR REFLOW SOLDERING
- TAPE AND REEL PACKAGING

**NSHC IS
RECOMMENDED
FOR NEW DESIGNS**



**RoHS
Compliant**
includes all homogeneous materials

*See Part Number System for Details

SPECIFICATIONS	Case Sizes			
	1913	2416	2820	2825
Capacitance Range	0.01 ~ 0.027 μ F	0.033 ~ .068 μ F	0.082 ~ 0.12 μ F	0.015 ~ 0.22 μ F
Voltage Ratings	100Vdc (40Vrms) max.			
Capacitance Tolerance	\pm 5% Std, \pm 2% Opt.			
Temperature Range	-55°C ~ +105°C			
Dissipation Factor (20°C)	0.6% max. @ 1KHz			
Insulation Resistance (20°C)	3 Gigohms Minimum			
Dielectric Withstanding Voltage	150% of Rated Voltage 60 Seconds			
Temperature Characteristic	\pm 1% Δ C Maximum Over Temperature Range Typical			
Dielectric Absorption	0.05 ~ 0.10% Typical			

ENVIRONMENTAL CHARACTERISTICS

Life Test At +105°C 1,000 Hours at 125% of Rated Voltage	Capacitance Change	Within \pm 2% of Initial Value
	Dissipation Factor	0.66% Maximum
	Insulation Resistance	1 Gigohm Minimum
Resistance to Soldering Heat +260°C Peak	Capacitance Change	Within \pm 3% of Initial Value
	Dissipation Factor	0.66% Maximum
	Insulation Resistance	1 Gigohm Minimum
Humidity Load Life: 1000 Hours, +40°C/95% RH	Capacitance Change	Within \pm 3% of initial value
	Dissipation Factor	0.90% maximum @ 1KHz
	Insulation Resistance	1 Gigohm minimum
	Dielectric Withstanding	130% of rated voltage for 60 seconds
Solderability with 25% Wt Rosin-Methanol Flux	90% Minimum Coverage After 2.5 Second Dip into 255°C Solder Pot	

RECOMMENDED REFLOW PROFILE (maximum 2 times)

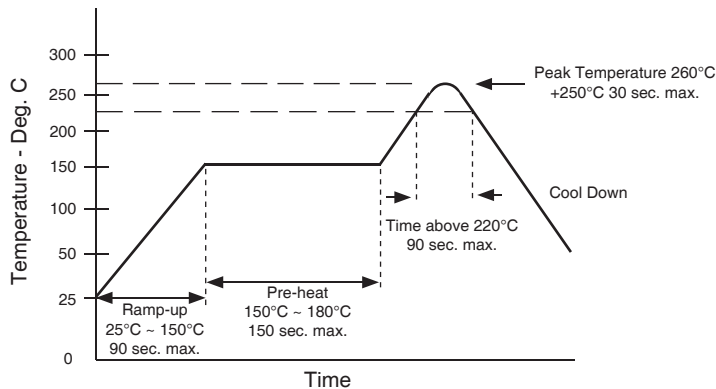

Solder within 6 year. Storage at +35°C and 85% RH

RECOMMENDED LAND PATTERN (mm)

EIA Size	A	B	C
1913	2.6	6.6	3.0
2416	3.8	7.8	3.8
2820	4.5	9.0	4.6
2825	4.5	9.0	5.7

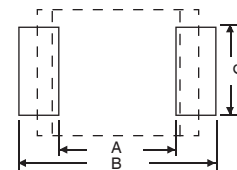

STANDARD PRODUCTS, SIZE CODE AND DIMENSIONS (mm)

Part Number	Cap.	Code	Working Voltage (VDC)	Length L	Width W	Height H	p	EIA Size Code	Reel Quantity
			100V						
NSHC103J100TRD1F	0.010	103	D1	4.8 ± 0.2	3.3 ± 0.3	1.4 ± 0.2	0.35 ± 0.2	1913	3000
NSHC123J100TRD1F	0.012	123	D1			2.0 ± 0.2			
NSHC153J100TRD2F	0.015	153	D2			2.4 ± 0.2			
NSHC183J100TRD2F	0.018	183	D2			2.8 ± 0.2			
NSHC223J100TRD3F	0.022	223	D3			1.8 ± 0.2			
NSHC273J100TRD4F	0.027	273	D4	2.0 ± 0.2					
NSHC333J100TRE1F	0.033	333	E1	2.4 ± 0.2					
NSHC393J100TRE2F	0.039	393	E2	2.8 ± 0.2					
NSHC473J100TRE3F	0.047	473	E3	3.2 ± 0.2					
NSHC563J100TRE4F	0.056	563	E4	7.1 ± 0.4	5.0 ± 0.4	2.8 ± 0.3	2820	1500	
NSHC683J100TRE5F	0.068	683	E5			3.0 ± 0.3			
NSHC823J100TRG2F	0.082	823	G2			3.4 ± 0.3			
NSHC104J100TRG3F	0.10	104	G3			3.4 ± 0.3			
NSHC124J100TRG5F	0.12	124	G5			4.0 ± 0.3			6.3 ± 0.4
NSHC154J100TRH2F	0.15	154	H2	4.0 ± 0.3					
NSHC184J100TRH4F	0.18	184	H4	4.8 ± 0.3					
NSHC224J100TRH6F	0.22	224	H6						

OUTLINE DRAWING

PART NUMBER SYSTEM

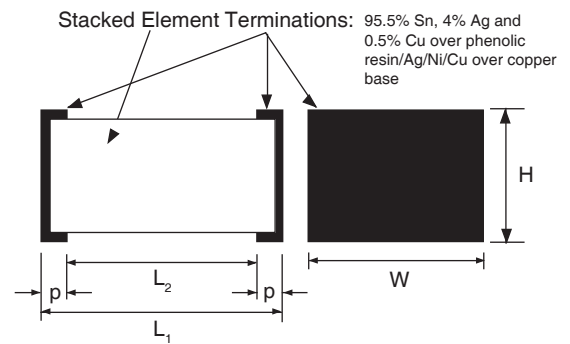
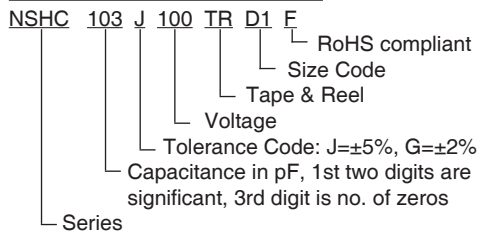

TAPE DIMENSIONS (mm)

Case Code	A±0.1	B±0.1	C±0.2	t	W±0.3	F	P±0.1	D±0.2/-0	Qty/Reel
D1	3.8	5.1	2.0	0.3 ± 0.05	12.0	5.5 ± 0.05	8.0	1.5	3,000
D2			2.6						3,000
D3, D4			3.4						2,000
E1, E2	4.6	6.3	2.7						3,000
E3, E4			3.5						2,000
E5			4.6	2,000					
G2 ~ G5	5.5	7.5	4.7						1,500
H2 ~ H6	6.91	8.43	5.686	0.343 ± 0.013	16	7.5 ± 0.1	12	1.5	1,000

EMBOSSED PLASTIC CARRIER

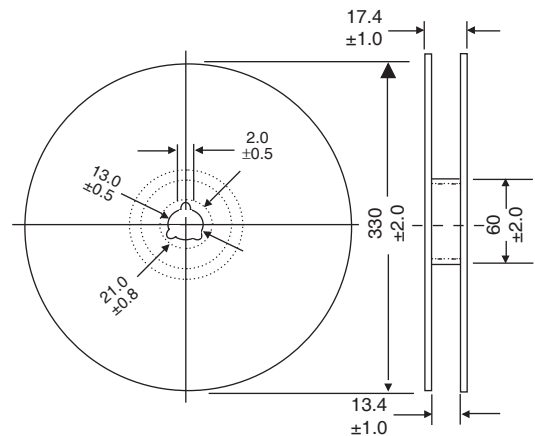
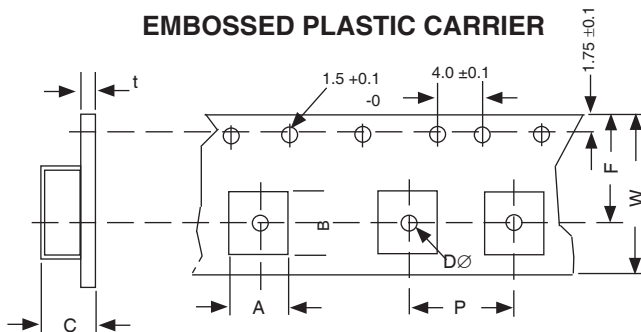

X-ON Electronics

Largest Supplier of Electrical and Electronic Components

Click to view similar products for [nic manufacturer](#):

Other Similar products are found below :

[NMC0603NPO270J100TRPF](#) [NRE-S100M25V4X7F](#) [NMC-P1206X7R104K100TRPF](#) [NCC0805F261HTRF](#) [NRWA470M35V6.3X11TBF](#)
[NACE221M16V6.3X8TR13F](#) [NRSS332M50V18X35.5F](#) [NDTM106K25F1TRF](#) [NACZ221M50V10X10.5TR13F](#) [NCM15X7R103K50F](#)
[NRSS682M25V18X35.5F](#) [NEXC224Z5.5V10.5X8.5TRF](#) [NRLRW221M450V30X35SF](#) [NDTM225K50F2TRF](#) [NEXT105Z5.5V21.5X13F](#)
[NRSZ471M50V12.5X20F](#) [NTCL106K35TRDF](#) [NRWA331M25V10X12.5F](#) [NRSY472M25V16X31.5F](#) [NEXS105Z5.5V28.5X14F](#)
[NRLR181M400V25X30SF](#) [NRSZ102M25V12.5X20F](#) [NUVA33T385TRF](#) [NUVA33V405TRF](#) [NRLMW331M250V30X25F](#)
[NRLF103M25V35X20F](#) [NDTM106K35F](#) [NRLMW102M200V35X35F](#) [NPIS43LS220MTRF](#) [NTC-T475K50TRDF](#) [NCD222M1KVZ5UKF](#)
[NRLR472M63V25X40SF](#) [NTP157M10TRD\(40\)F](#) [NPIM74C3R3MTRF](#) [NPI104C100MTRF](#) [NRLM102M100V25X25F](#) [NRLM223M50V](#)
[35X50F](#) [NAZT221M50V10X10.5LBF](#) [NACK102M10V 10X10.5TR13F](#) [NACZ221M35V8X10.5TR13F](#) [NRWA101M10V5X11F](#) [NTC-](#)
[T336K16TRCF](#) [NRWP102M16V10X12.5F](#) [NRLM822M50V30X35F](#) [NACE470M63V8X10.5TR13F](#) [NCD4R7C1KVNPOF](#) [NRSZ152M35V](#)
[16X25F](#) [NRSH222M63V18X40F](#) [NRLM123M16V25X25F](#) [NRLMW103M50V35X40F](#)