

Capteur de Fenêtres-Feuillures Sensors for window frames

PW . 01501

- Capteur de proximité magnétique à ampoule REED
- Développé pour détection de l'état de la fenêtre : Ouverte / Fermée
- Clip de verrouillage compris dans la référence PW
- Connecteur à verrouillage



- *Magnetic proximity sensor with REED switch*
- *Developed to detect position of the window : Open / Closed.*
- *Locking clip included in PW reference*
- *Connector with secure locking*

Dimensions (mm)

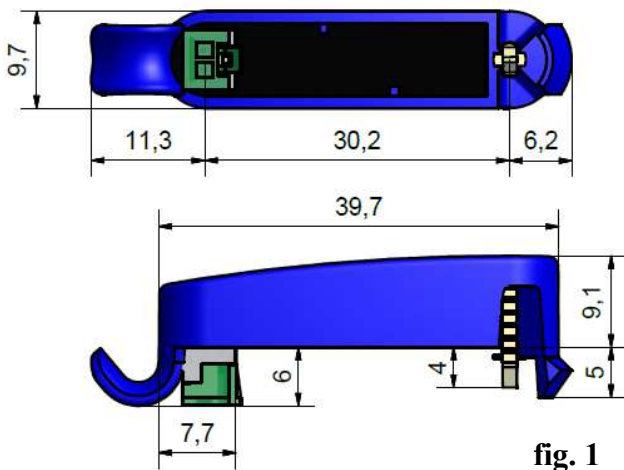
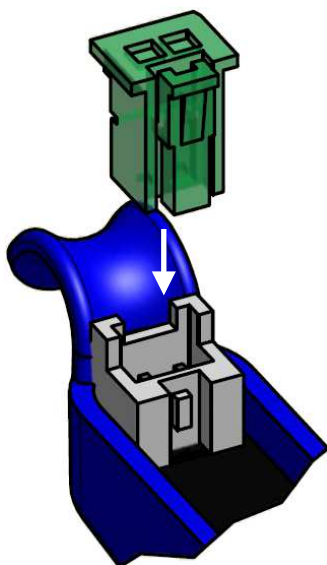

fig. 1

Caractéristiques / Specifications

	PWA	PWB
Puissance maximum commutable / Max switching power	10 VA	3 VA
Courant maximum commutable / Max switching current	0,4 A	0,25 A
Tension maximale commutable / Max switching voltage	100 Vdc	100 Vdc
Tension de tenue / Dielectric strength	250 Vdc	150 Vdc
Courant passant maximum / Maximum carried current	1 A	0,5 A
Résistance de contact Reed / Reed Contact resistance only	150 mΩ	150 mΩ
Résistance d'isolement / Insulation resistance	10 ¹² Ω	10 ⁹ Ω
Température de fonctionnement / Operating Temperature	-40 / +70 °C	
Dimensions / Dimensions	fig. 1	
Distances de détection / Operating distances	pages 3 et 4	
Matériau du boîtier / Housing material	PA6	
Résistance à la traction / Tensile strength	> 20 Nm	

Connecteur à verrouillage / Connector with secure locking





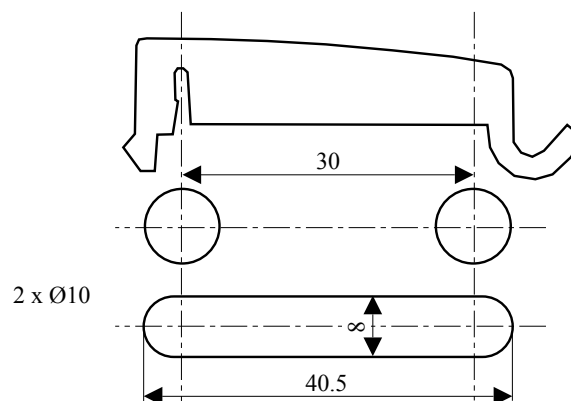

Plans de perçage - épaisseur de 1 à 2 mm / Drilling plan - thickness of 1 to 2 mm

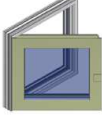

Partie capteur sur le dormant de la fenêtre - Partie Aimant sur l'ouvrant. /
Sensor mounted on the fixed part and magnet on the moving part.

Proud to serve you

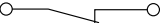
Fonctions / Functions :

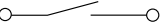
Réf.capteur Sensor Ref.	Nature du contact / Type of contact.	Etat fenêtre / Window status.	
			
		Etat des contacts / Contact(s) status.	
PWA01501	NO (contact ouvert en absence d'aimant) NO (contact is open if no magnet)		
PWB01501	NF (contact fermé en absence d'aimant) NC (contact is closed if no magnet)		

Accessoires / Accessories:

Référence	Désignation / Designation :	
UZ189538	Aimant Ferrite (à coller) / Magnet Ferrite (to be glued)	Lg 18mm x lg 9.5mm ép. 3.8mm
PW520000	Aimant boîtier PW (à clipser) / Magnet PW (to be clipped)	Ø5 Lg 20mm-NdFeB
UR102540	Aimant NdFeB (à visser) / Magnet NdFeB (to be screwed)	Ø10 - trou(holl)2,5 - ép/thickness 4mm
UR124540	Aimant NdFeB (à visser) / Magnet NdFeB (to be screwed)	Ø12 - trou(holl)4,5 - ép/thickness 4mm
UR144360	Aimant NdFeB (à visser) / Magnet NdFeB (to be screwed)	Ø14 - trou(holl)4,3 - ép/thickness 6mm
2YB20031	Câble / cable: 2x0.22 ² Lg 3m + connecteur PAP-02V-S	
2YB20051	Câble / cable: 2x0.22 ² Lg 5m + connecteur PAP-02V-S	
2YB20111	Câble / cable: 2x0.22 ² Lg 10m + connecteur PAP-02V-S	
1LM00100	Sachet Clips de Verrouillage / Bag locking clips (16pcs)	Clip Lg 11mm

Type de fenêtres / Kind of windows:

• Fenêtre à la française
(French window)



• à soufflet
(Hopper window)



• coulissante
(Sliding window)



• à l'italienne
(awning window)



Proud to serve you

All technical characteristics are subject to change without previous notice.
Caractéristiques sujettes à modifications sans préavis.

celduc®
r e l a i s

Principe de Montage / Steps for mounting :

① Perçage /
Drilling

② Raccordement /
Connecting

③ Mise en place du capteur /
Positioning sensor.

④ Mise en Place et Verrouillage /
Positioning & Locking for clip

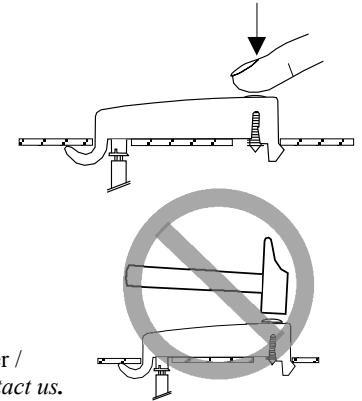
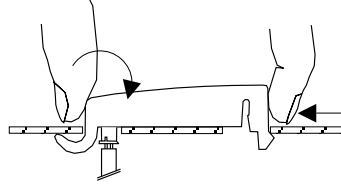
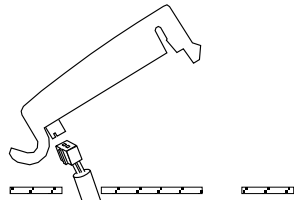
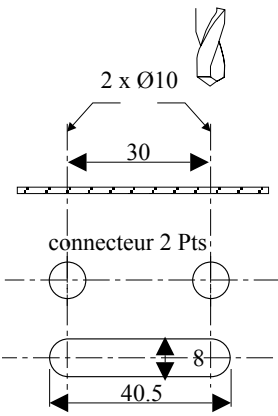

Adaptées aux fenêtres aluminium, plastique, et bois - acier, nous consulter /
Adapted for windows in aluminium, plastic, and wood - Steel, please contact us.

Distances de fonctionnement / Activation distances :

PW520000 (à clipser)
(to be clipped)



UZ189538 (à coller)
(to be glued)



 Zone garantie pour laquelle le capteur a changé d'état.
Guaranteed zone for which the sensor changed state.

* Dès que ce repère entre dans la zone "verte" le capteur change d'état.
* As soon as this marker is inside green zone the sensor changed state.

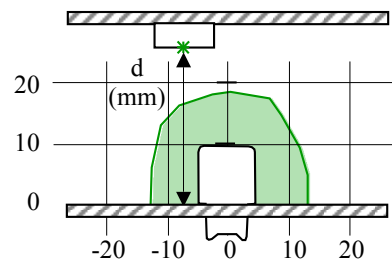
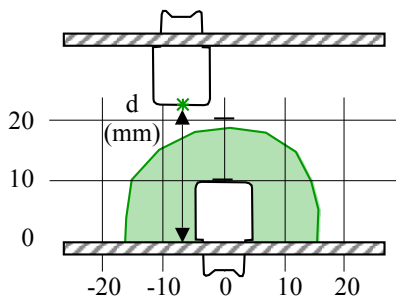
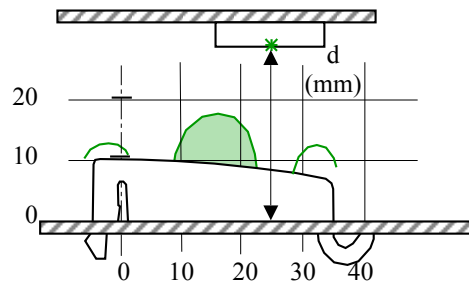
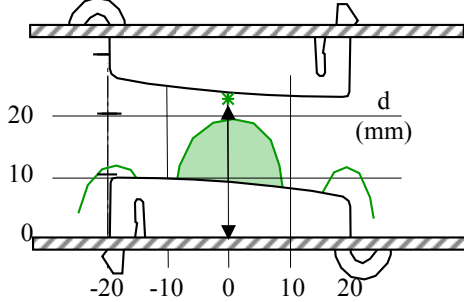

Proud to serve you

All technical characteristics are subject to change without previous notice.
Caractéristiques sujettes à modifications sans préavis.

celduc®
r e l i a i s

Distances de fonctionnement / Activation distances :**UR124540 (à visser)
(to be screwed)**

Vis/Screw M4 max

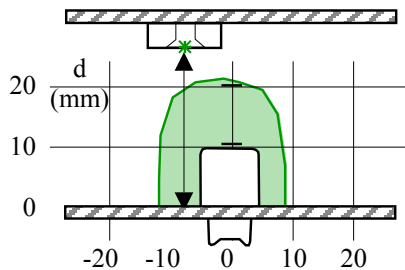
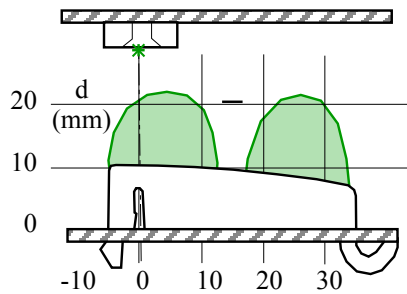
**UR144360 (à visser)
(to be screwed)**

Vis/Screw M4 max

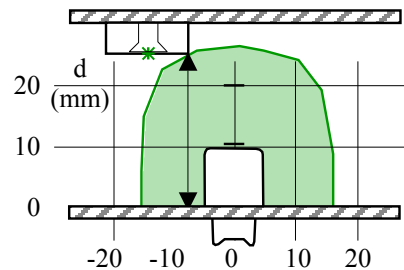
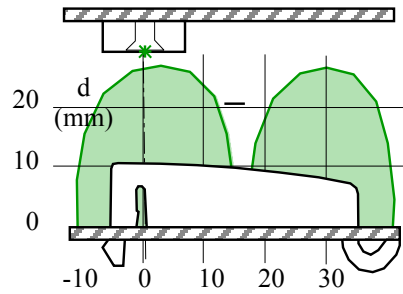
**UR102540 (à visser)
(to be screwed)**

vis Ø 2.5 max

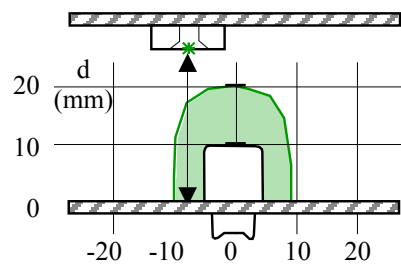
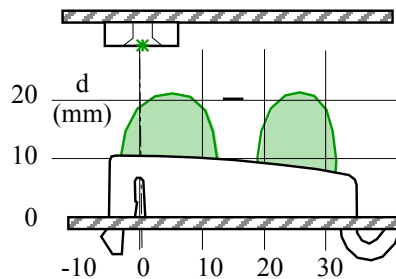

X-ON Electronics

Largest Supplier of Electrical and Electronic Components

Click to view similar products for [Proximity Sensors](#) category:

Click to view products by [Celduc](#) manufacturer:

Other Similar products are found below :

[01.001.5653.1](#) [70.340.1028.0](#) [70.360.2428.0](#) [70.364.4828.0](#) [70.810.1053.0](#) [72.360.1628.0](#) [73.363.6428.0](#) [9221350022](#) [980659-1](#) [QT-12](#)
[E2EX10D1NN](#) [E2E-X14MD1-G](#) [E2E-X2D1-G](#) [E2EX2ME2N](#) [E2E-X3D1-N 10M](#) [E2E-X4MD1-G](#) [E2FMX1R5D12M](#) [E2K-F10MC1 5M](#)
[EI1204TBOSL-6](#) [EI5515NPAP](#) [BSA-08-25-08](#) [IC08ANC15PO-K](#) [IMM2582C](#) [25.161.3253.0](#) [25.332.0653.1](#) [25.352.0653.0](#) [25.352.0753.0](#)
[25.523.3253.0](#) [9151710023](#) [922FS1.5C-A4P-Z774](#) [SC606ABV0S30](#) [SM952A126100LE](#) [A1220EUA-T](#) [F3S-A162-U](#) [CL18](#) [QT-08L](#)
[34.110.0010.0](#) [TL-C2MF1-M3-E4](#) [IA08BLF15NOM5](#) [IA08BSF15NOM5](#) [IA12ASF04DOM1](#) [IMM32188C](#) [IS2](#) [IS31SE5000-UTLS2-TR](#)
[34.110.0021.0](#) [34.110.0022.0](#) [CA150-120VACDC](#) [VM18VA3000Q](#) [XS508BSCBL2](#) [XS512BLNAM12](#)