

### FEATURES

- 1. Breakthrough height of 9.8 mm .386 inch beats the 10 mm .394 inch limit**  
1c and 2c all have the same height (9.8 mm .386 inch). The width of the relay is also the same (9.9 mm .390 inch). Since the only size variable is the length, the shared form makes mounting on printed printing wiring boards easy.
- 2. Suitable for use in difficult environments**  
Epoxy resin seals the parts and cut off the external atmosphere, thus enabling use in difficult environments.
- 3. Can be used with automatic solder and automatic wash systems**  
Automatic soldering and automatic washing can be carried out once the parts are mounted on PC boards.
- 4. Gold-clad twin contacts ensure high reliability**  
Highly stable gold cladding on the contacts ensures that contact resistance changes little over time. Furthermore, the use of twin contacts, a configuration that performs with superior contact reliability, ensures extremely low contact failure rates even under low level loads.
- 5. Polarized magnetic circuits realize resistance to shock and vibration**  
High-performance polarized magnetic circuits that utilize the energy of permanent magnets have made it possible to create relays with strong resistance to shock and vibration.
- 6. DIL terminal array enables use of IC sockets**
- 7. Widening scope of application with multicontact latching**  
In addition to single side stable types, you can take advantage of the memory of functions of convenient 2 coil latching relays.

### TYPICAL APPLICATIONS

Besides telecommunications, measuring devices, office equipment, computers and related equipment, DS relays are also recommended for a broad range of applications including business devices, audio systems, and industrial equipment.

RoHS compliant

### ORDERING INFORMATION

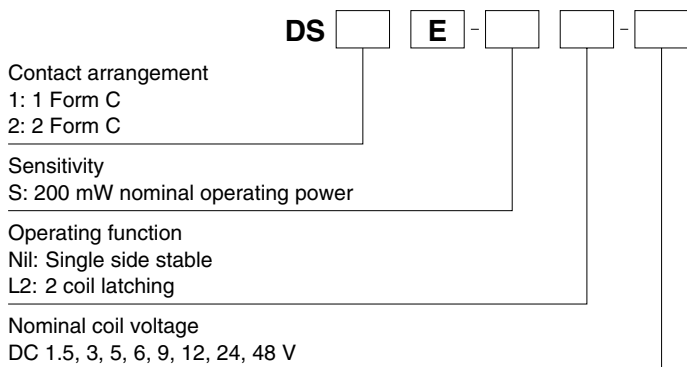

Note: \* Nominal coil voltage 1.5V type are 1 Form C only.

## TYPES

### 1. High sensitivity type

Contact arrangement	Nominal coil voltage	Single side stable type	2 coil latching type
		Part No.	Part No.
1 Form C	1.5V DC	DS1E-S-DC1.5V	DS1E-SL2-DC1.5V
	3V DC	DS1E-S-DC3V	DS1E-SL2-DC3V
	5V DC	DS1E-S-DC5V	DS1E-SL2-DC5V
	6V DC	DS1E-S-DC6V	DS1E-SL2-DC6V
	9V DC	DS1E-S-DC9V	DS1E-SL2-DC9V
	12V DC	DS1E-S-DC12V	DS1E-SL2-DC12V
	24V DC	DS1E-S-DC24V	DS1E-SL2-DC24V
	48V DC	DS1E-S-DC48V	DS1E-SL2-DC48V
2 Form C	3V DC	DS2E-S-DC3V	DS2E-SL2-DC3V
	5V DC	DS2E-S-DC5V	DS2E-SL2-DC5V
	6V DC	DS2E-S-DC6V	DS2E-SL2-DC6V
	9V DC	DS2E-S-DC9V	DS2E-SL2-DC9V
	12V DC	DS2E-S-DC12V	DS2E-SL2-DC12V
	24V DC	DS2E-S-DC24V	DS2E-SL2-DC24V
	48V DC	DS2E-S-DC48V	DS2E-SL2-DC48V

Standard packing: Tube: 50 pcs.; Case: 500 pcs.

## RATING

### 1. Coil data

#### 1) Single side stable type

Type	Nominal coil voltage	Pick-up voltage (at 20°C 68°F)	Drop-out voltage (at 20°C 68°F)	Nominal operating current [±10%] (at 20°C 68°F)	Coil resistance [±10%] (at 20°C 68°F)	Nominal operating power	Max. applied voltage (at 50°C 122°F)
High sensitivity (S) type	1.5V DC*	1 Form C: 80%V or less of nominal voltage 2 Form C: 70%V or less of nominal voltage (Initial)	10%V or more of nominal voltage (Initial)	133.3mA	11.3Ω	200mW	1 Form C: 160%V of nominal voltage  2 Form C: 200%V of nominal voltage
	3V DC			66.7mA	45Ω		
	5V DC			40.0mA	125Ω		
	6V DC			33.3mA	180Ω		
	9V DC			22.2mA	405Ω		
	12V DC			16.7mA	720Ω		
	24V DC			8.3mA	2,880Ω		
	48V DC			4.2mA	11,520Ω		

#### 2) 2 coil latching type

Type	Nominal coil voltage	Set voltage (at 20°C 68°F)	Reset voltage (at 20°C 68°F)	Nominal operating current [±10%] (at 20°C 68°F)		Coil resistance [±10%] (at 20°C 68°F)		Nominal operating power		Max. applied voltage (at 50°C 122°F)
				Set coil	Reset coil	Set coil	Reset coil	Set coil	Reset coil	
High sensitivity (S) type	1.5V DC*	1 Form C: 80%V or less of nominal voltage 2 Form C: 70%V or less of nominal voltage (Initial)	1 Form C: 80%V or less of nominal voltage 2 Form C: 70%V or less of nominal voltage (Initial)	120mA	120mA	12.5Ω	12.5Ω	180mW	180mW	1 Form C: 160%V of nominal voltage  2 Form C: 200%V of nominal voltage
	3V DC			60mA	60mA	50Ω	50Ω			
	5V DC			36mA	36mA	139Ω	139Ω			
	6V DC			30mA	30mA	200Ω	200Ω			
	9V DC			20mA	20mA	450Ω	450Ω			
	12V DC			15mA	15mA	800Ω	800Ω			
	24V DC			7.5mA	7.5mA	3,200Ω	3,200Ω			
	48V DC			3.75mA	3.75mA	12,800Ω	12,800Ω			

\* Nominal coil voltage 1.5V type are 1 Form C only.

## 2. Specifications

Characteristics	Item	Specifications	
		1 Form C	2 Form C
Contact	Arrangement		
	Initial contact resistance, max.	Max. 50 mΩ (By voltage drop 6 V DC 1A)	
	Contact material	Ag+Au clad	
Rating	Nominal switching capacity	2 A 30 V DC (resistive load)	
	Max. switching power	60 W, 125 VA (resistive load)	
	Max. switching voltage	220 V DC, 250 V AC	
	Max. carrying current	3 A	
	Min. switching capacity (Reference value)*1	10μA 10m V DC	
	Nominal operating power	Single side stable (S type: 200 mW); latching (S type: 180 mW)	
Electrical characteristics	Insulation resistance (Initial)	Min. 100MΩ (at 500V DC) Measurement at same location as "Initial breakdown voltage" section.	
	Breakdown voltage (Initial)	Between open contacts	1,000 Vrms for 1min. (500 Vrms for 1min: 1 Form C type) (Detection current: 10mA.)
		Between contact and coil	1,500 Vrms for 1min. (1,000 Vrms for 1min: 1 Form C type) (Detection current: 10mA.)
	Temperature rise	Max. 65°C (By resistive method, nominal coil voltage applied to the coil, contact carrying current: 2A.)	
	Operate time [Set time] (at 20°C 68°F)	Max. 10 ms [10 ms] (Nominal coil voltage applied to the coil, excluding contact bounce time.)	
	Release time [Reset time] (at 20°C 68°F)	Max. 5 ms [10 ms] (Nominal coil voltage applied to the coil, excluding contact bounce time.) (without diode)	
Mechanical characteristics	Shock resistance	Functional*2	Min. 490 m/s <sup>2</sup>
		Destructive	Min. 980 m/s <sup>2</sup> (Half-wave pulse of sine wave: 6 ms.)
	Vibration resistance	Functional	10 to 55 Hz at double amplitude of 3.3 mm (Detection time: 10μs.)
		Destructive	10 to 55 Hz at double amplitude of 5 mm
Expected life	Mechanical	Min. 10 <sup>8</sup> (10 <sup>7</sup> : 1 Form C latching type) (at 600 cpm)	
	Electrical	Min. 5×10 <sup>5</sup> rated load (at 60 cpm)	
Conditions	Conditions for operation, transport and storage*3	Ambient temperature: -40°C to +70°C -40°F to +158°F Humidity: 5 to 85% R.H. (Not freezing and condensing at low temperature)	
	Max. operating speed (at rated load)	60 cpm	
Unit weight		Approx. 3 g .11 oz	Approx. 4g .14oz

Notes: \*1 This value can change due to the switching frequency, environmental conditions, and desired reliability level, therefore it is recommended to check this with the actual load. (TX/TX-S/TX-D relay AgPd contact type are available for low level load switching [10V DC, 10mA max. level])

\*2 Half-wave pulse of sine wave: 11ms; detection time: 10μs

\*3 Refer to 6. Conditions for operation, transport and storage mentioned in AMBIENT ENVIRONMENT (Page 24).

# REFERENCE DATA

## 1. Maximum switching capacity

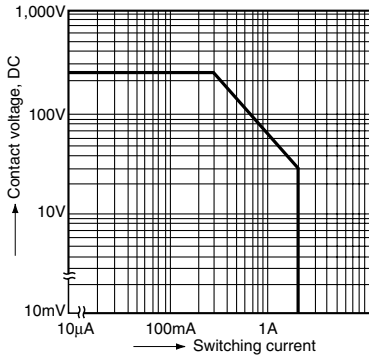

## 2. Life curve (Resistive load)

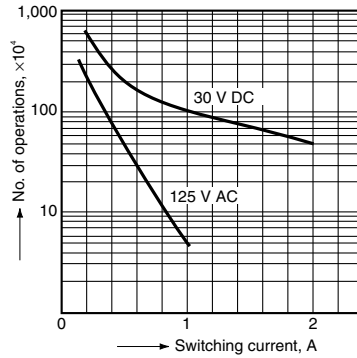

## 3. Contact reliability for AC loads

Tested sample: DS2E-S-DC24V 10 pcs.  
 Operating speed: 20 cpm.  
 Detection level: 200 mΩ

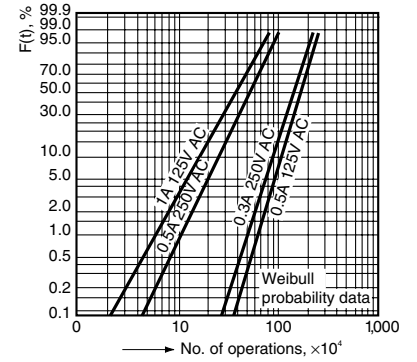

## 4. Operate and release time characteristics (2 Form C single side stable type)

Test condition: Without diode connected to coil in parallel

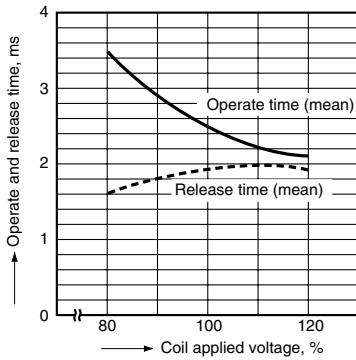

## 5-(1). Influence of adjacent mounting (1 Form C)

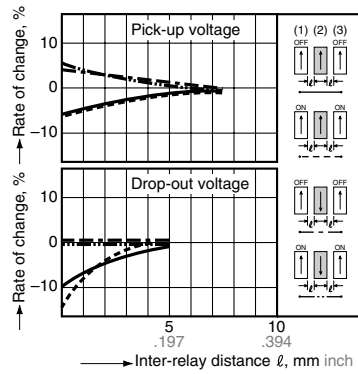

## 5-(2). Influence of adjacent mounting (2 Form C)

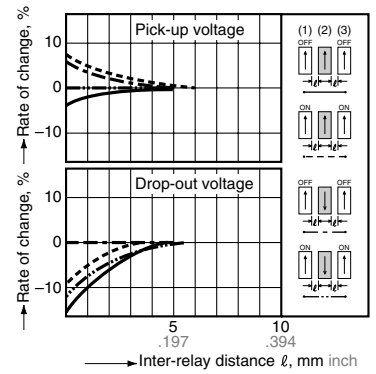

# DS

## DIMENSIONS (mm inch)

The CAD data of the products with a **CAD Data** mark can be downloaded from: <http://industrial.panasonic.com/ac/e/>

### DS (1 Form C)

Single side stable, 2 coil latching

**CAD Data**

External dimensions

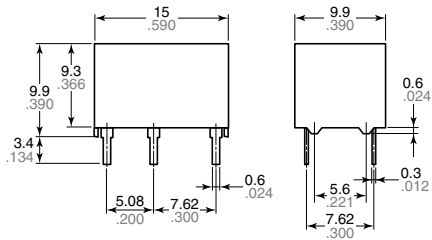

General tolerance:  $\pm 0.3 \pm 0.012$

PC board pattern (Bottom view)

Single side stable

2 coil latching

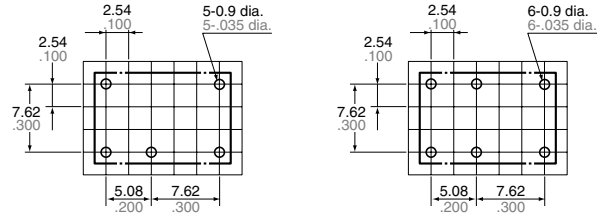

Schematic (Bottom view)

Single side stable

2 coil latching

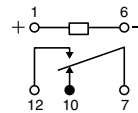

(Deenergized condition)

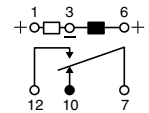

(Reset condition)

Tolerance:  $\pm 0.1 \pm 0.004$

Note: External dimensions of 1 coil latching types are same as single side stable type.

### DS (2 Form C)

Single side stable

**CAD Data**

External dimensions

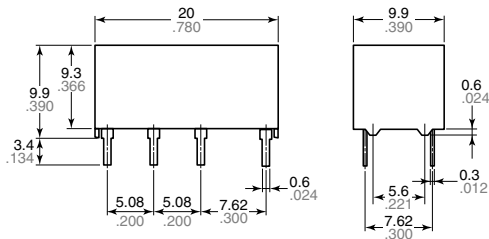

General tolerance:  $\pm 0.3 \pm 0.012$

PC board pattern (Bottom view)

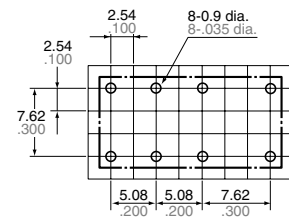

Schematic (Bottom view)

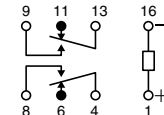

(Deenergized condition)

Tolerance:  $\pm 0.1 \pm 0.004$

Note: External dimensions of 1 coil latching types are same as single side stable type.

### DS (2 Form C)

2 coil latching

**CAD Data**

External dimensions

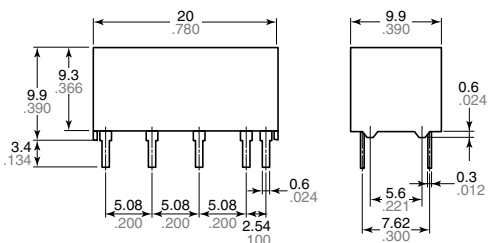

General tolerance:  $\pm 0.3 \pm 0.012$

PC board pattern (Bottom view)

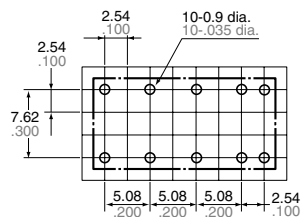

Schematic (Bottom view)

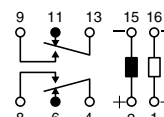

(Reset condition)

Tolerance:  $\pm 0.1 \pm 0.004$

---

## NOTES

### 1. Coil connection

When connecting coils, refer to the wiring diagram to prevent mis-operation or malfunction.

**For general cautions for use, please refer to the “Cautions for use of Signal Relays” or “General Application Guidelines”.**

## X-ON Electronics

Largest Supplier of Electrical and Electronic Components

*Click to view similar products for [Low Signal Relays - PCB category](#):*

*Click to view products by [Panasonic manufacturer](#):*

Other Similar products are found below :

[6-1393813-4](#) [6-1462039-0](#) [6-1617529-6](#) [617-12](#) [M39016/11-048P](#) [67RPCX-3](#) [7-1393809-0](#) [7-1393813-3](#) [7556072001](#) [80.010.4522.1](#) [FTR-B4GA006Z](#) [FW1210S02](#) [9-1393813-6](#) [9-1617519-3](#) [9-1617582-5](#) [G6AK-2-H-DC5](#) [A-1.5W-K](#) [DF2E-L2-DC3V](#) [DS1EM24J](#) [DS1EM5J](#) [DS1ES5J](#) [DS4E-M-DC5V-H48](#) [EC2-4.5TNJ](#) [EC2-9NJ](#) [B07B939BC1-0868](#) [1608043-4](#) [1617076-5](#) [1617117-3](#) [1617137-2](#) [1617518-5](#) [1617560](#) [HMB1130K00](#) [HMB1131S06](#) [HMS1119S01](#) [HMS1131S10](#) [HMS1201S03](#) [HMS1201S87](#) [HMS1205S02](#) [2-1393807-6](#) [2-1617071-2](#) [2-1617594-1](#) [JMGSC-5LW](#) [K6-PS](#) [KHS-17D11-110](#) [9-1393761-0](#) [9-1617352-3](#) [9-1617583-1](#) [276XAXH-9D](#) [1617072-3](#) [1617075-4](#)