

SCOOP

wall mounting receptacle

- Olive drab chromate over cadmium plate finish
- Primed inserts and potting boot provided for customer applied potting compounds

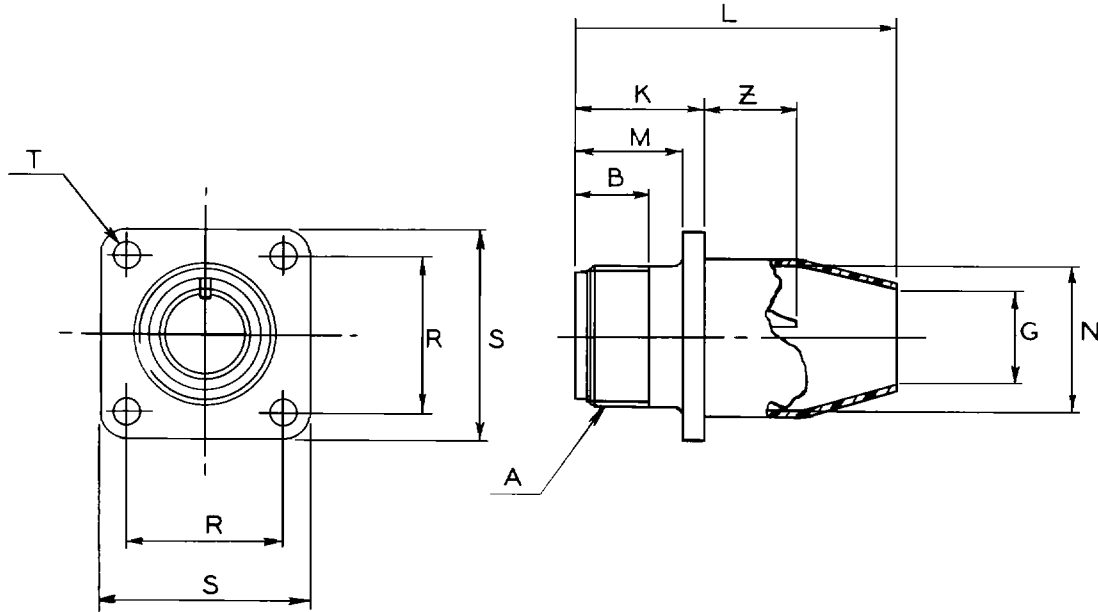
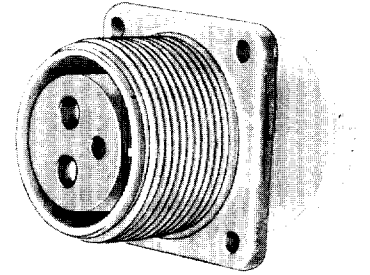

For contact data see Catalog 12-020.

NOTE:

Size "0" contacts must be individually sleeved. Use vinyl tubing, or equivalent, of suitable length and diameter.

MS Shell Size	Order Number**	A Thread Class 2A	B Min. Full Thd.	G Dia.	K +.020 - .010	L Max.	M +.010 - .000	N Dia. +.010 - .000	R ±.005	S ±.031	T Dia. +.004 - .002	Z -.050 - .060
8S	SC00P-8S-	.5000-28UNEF	.391	.288	.672	1.375	.562	.516	.594	.875	.120	.422
10S	SC00P-10S-	.6250-24NEF	.391	.359	.672	1.375	.562	.609	.719	1.000	.120	.422
12S	SC00P-12S-	.7500-20UNEF	.450	.484	.672	1.375	.562	.766	.812	1.094	.120	.422
12	SC00P-12-	.7500-20UNEF	.625	.484	.860	1.789	.750	.766	.812	1.094	.120	.672
14S	SC00P-14S	.8750-20UNEF	.450	.609	.672	1.375	.562	.844	.906	1.188	.120	.422
14	SC00P-12-	.8750-20UNEF	.625	.609	.860	1.781	.750	.844	.906	1.188	.120	.672
16S	SC00P-16S	1.0000-20UNEF	.450	.734	.672	1.375	.562	.969	.969	1.281	.120	.422
16	SC00P-16-	1.0000-20UNEF	.625	.734	.860	1.781	.750	.969	.969	1.281	.120	.672
18	SC00P-18-	1.1250-18NEF	.625	.859	.891	1.812	.750	1.094	1.063	1.375	.120	.641*
20	SC00P-20-	1.2500-18NEF	.625	.984	.891	1.812	.750	1.219	1.156	1.500	.120	.641*
22	SC00P-22-	1.3750-18NEF	.625	1.109	.891	1.812	.750	1.344	1.250	1.625	.120	.641*
24	SC00P-24-	1.5000-18NEF	.625	1.234	.953	1.812	.812	1.469	1.375	1.750	.147	.578*
28	SC00P-28-	1.7500-18NS	.625	1.427	.953	1.812	.812	1.719	1.562	2.000	.147	.578*
32	SC00P-32-	2.0000-18NS	.625	1.708	1.031	1.828	.875	2.000	1.750	2.250	.173	.500*
36	SC00P-36-	2.2500-16UN	.625	1.895	1.031	1.828	.875	2.219	1.938	2.500	.173	.500*
40	SC00P-40-	2.5000-16UN	.625	2.130	1.031	1.828	.875	2.469	2.188	2.750	.173	.500*

Increase Z dimension, so marked (), by .312 for size "0" contact only.

HOW TO ORDER

**To order, select base number above; Add insert from "Contact and Arrangements" section, Catalog 12-020; Add pins P or sockets S. Example: SC00P-18-1P.

SC01P

cable connecting plug

- Olive drab chromate over cadmium plate finish
- Primed inserts and potting boot provided for customer applied potting compounds

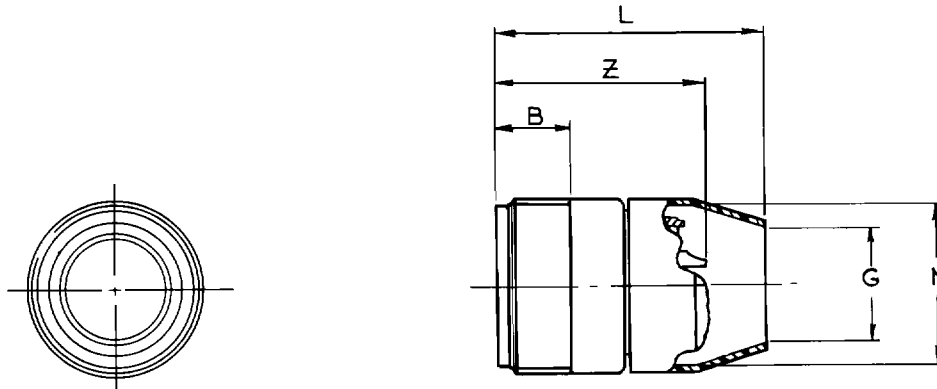
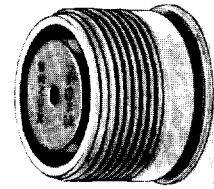

For contact data see Catalog 12-020.

NOTE:

Size "0" contacts must be individually sleeved. Use vinyl tubing, or equivalent, of suitable length and diameter.

MS Shell Size	Order Number**	A Thread Class 2A	B Min Full Thd.	G Dia.	L Max.	N Dia +.010 -.000	Z ± .040
8S	SC01P-8S-	.5000-28UNEF	.406	.288	1.350	.516	1.094
10S	SC01P-10S-	.6250-24NEF	.406	.359	1.375	.609	1.094
10SL	SC01P-10SL-	.6250-24NEF	.406	.484	1.351	.766	1.094
12S	SC01P-12S-	.7500-20UNEF	.422	.484	1.375	.766	1.094
12	SC01P-12-	.7500-20UNEF	.656	.484	1.827	.766	1.532
14S	SC01P-14S-	.8750-20UNEF	.391	.609	1.375	.844	1.094
14	SC01P-14-	.8750-20UNEF	.625	.609	1.827	.844	1.532
16S	SC01P-16S-	1.0000-20UNEF	.391	.734	1.375	.969	1.094
16	SC01P-16-	1.0000-20UNEF	.625	.734	1.827	.969	1.532
18	SC01P-18-	1.1250-18NEF	.625	.859	1.827	1.094	1.532*
20	SC01P-20-	1.2500-18NEF	.625	.984	1.827	1.219	1.532*
22	SC01P-22-	1.3750-18NEF	.625	1.109	1.827	1.344	1.532*
24	SC01P-24-	1.5000-18NEF	.625	1.234	1.827	1.469	1.532*
28	SC01P-28-	1.7500-18NS	.625	1.427	1.827	1.719	1.532*
32	SC01P-32-	2.0000-18NS	.625	1.708	1.827	2.000	1.532*
36	SC01P-36-	2.2500-16UN	.625	1.895	1.827	2.219	1.532*
40	SC01P-40-	2.5000-16UN	.625	2.130	1.827	2.469	1.532*

Increase Z dimension, so marked (), by .312 for size "0" contact only.

HOW TO ORDER

**To order, select base number above; Add insert from "Contact and Arrangements" section, Catalog 12-020; Add pins P or sockets S. Example: SC01P-18-1P.

SC06P straight plug

- Olive drab chromate over cadmium plate finish
- Primed inserts and potting boot provided for customer applied potting compounds

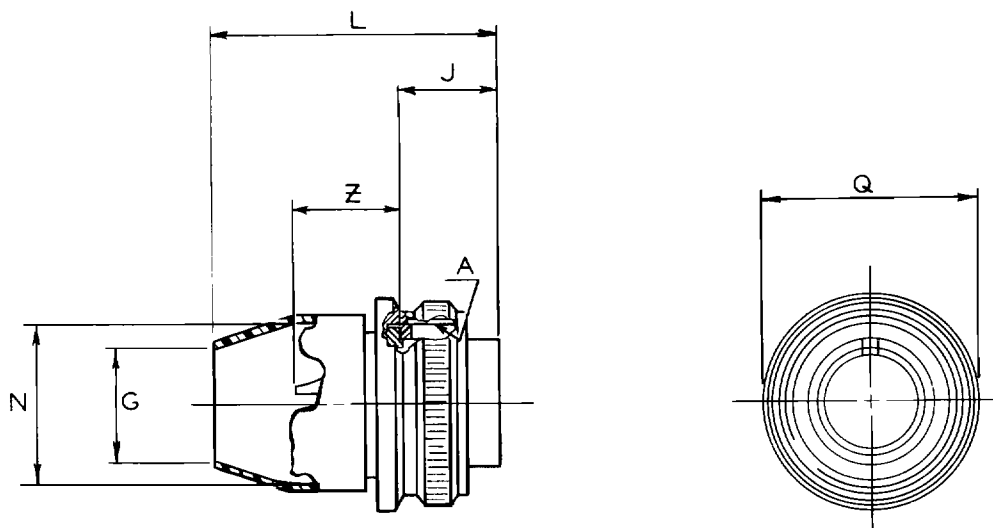
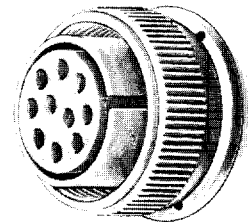

For contact data see Catalog 12-020.

All lockwire holes .045 Dia. Min.

NOTE:

Size "0" contacts must be individually sleeved. Use vinyl tubing, or equivalent, of suitable length and diameter.

MS Shell Size	Order Number**	A Thread Class 2B	G Dia.	J ± .005	L Max.	N Dia. +.010 - .000	Q Dia. Max.	Z ± .045
8S	SC06P-8S	.5000-28UNEF	.288	.531	1.449	.516	.760	.562
10S	SC06P-10S	.6250-24NEF	.359	.531	1.449	.609	.885	.562
12S	SC06P-12S	.7500-20UNEF	.484	.531	1.449	.766	1.010	.562
12	SC06P-12	.7500-20UNEF	.484	.719	1.901	.766	1.010	.812
14S	SC06P-14S	.8750-20UNEF	.609	.531	1.449	.844	1.135	.562
14	SC06P-14	.8750-20UNEF	.609	.719	1.901	.844	1.135	.812
16S	SC06P-16S	1.0000-20UNEF	.734	.531	1.449	.969	1.260	.562
16	SC06P-16	1.0000-20UNEF	.734	.719	1.901	.969	1.260	.812
18	SC06P-18	1.1250-18NEF	.859	.719	1.901	1.094	1.354	.812*
20	SC06P-20	1.2500-18NEF	.984	.719	1.901	1.219	1.479	.812*
22	SC06P-22	1.3750-18NEF	1.109	.719	1.901	1.344	1.604	.812*
24	SC06P-24	1.5000-18NEF	1.234	.719	1.901	1.469	1.729	.812*
28	SC06P-28	1.7500-18NS	1.427	.719	1.901	1.719	1.979	.812*
32	SC06P-32	2.0000-18NS	1.708	.719	1.901	2.000	2.229	.812*
36	SC06P-36	2.2500-16UN	1.895	.719	1.901	2.219	2.479	.812*
40	SC06P-40	2.5000-16UN	2.130	.719	1.901	2.469	2.729	.812*

Increase Z dimension, so marked (), by .312 for size "0" contact only.

HOW TO ORDER

**To order, select base number above; Add insert from "Contact and Arrangements" section, Catalog 12-020; Add pins P or sockets S. Example: SC06P-18-1P.

Bendix® MS Modified Cylindrical Connectors

The Bendix® MS Modified connector series has been established to supplement standard MS shell styles and provide a greater variety of styles for the electrical connector user.

The MS and MS Modified series offer the same insert arrangements and electrical ratings as illustrated and tabulated in the "Contacts and Arrangements" section beginning on pg. 12, Catalog 12-020. In addition, the MS Modified series is available with special arrangements (Catalog 12-020, pg. 47). Standard MS coupling threads and polarization are employed. Aluminum components are cadmium plated with either an olive drab chromate or clear chromate after treatment. Contacts are fabricated from high grade

copper alloys and are generally silver plated. Size 16 and 12 socket contacts incorporate a closed entry design.

A recent addition to the MS Modified types is the 10-214XXX series connector (pages 16 to 23). This versatile series utilizes insertable crimp type contacts, and is designed to accommodate Navy controlled multi-conductor armored cable per MIL-C-915 or MIL-C-2194. Contacts are silver plated with a 30/50 micro-inch gold overplate. Application tooling is fully coordinated and available with the 10-214XXX series.

How to order

If the MS Modified connector desired is a 10-order number (for example, 10-720XX, page 5) use order information below. If the connector desired is not a 10-order number (for example, FP3106-XX, page 4) use the order information supplied on the bottom of the page covering that connector.

FOR 10- ORDER NUMBERS

- (1) Select the desired base 10- order number. To this base number add desired contact arrangement from the "Contacts and Arrangements" section. Add "P" or "S" to specify pin or socket contacts. A complete order number for a 10-72008/40 wall mounting receptacle in shell size 18 with an MS arrangement of 18-1 with pin contacts and with the insert in the normal position is:

10-72018-1P

- (2) When an alternate position of the insert is required this is indicated by adding another letter such as "W" to the ordering number listed

in (1) above. When alternate insert location is desired, select from the tables below the one letter that indicates both the kind of contacts and the insert location you require and add it to the order number.

PIN CONTACTS	
MS Letters	Bendix® Letter
PW	G
PX	I
PY	K
PZ	M

SOCKET CONTACTS	
MS Letters	Bendix® Letter
SW	H
SX	J
SY	L
SZ	N

The order number for a 10-72008/40 wall mounting receptacle in shell size 18 with an MS arrangement of 18-1 with pin contacts and with the insert located in alternate position "W" would be:

10-72018-1G

MS/Standard insert arrangements

Insert Arrangement	Service Rating	Total Contacts	Contact Size				
			0	4	8	12	16
8S-1	A	1					1
10S-2	A	1					1
10SL-3	A	3					3
10SL-4*	A	2					2
12S-3	A	2					2
12S-4	D	1					1
12-5	D	1				1	
14S-2	Inst.	4					4
14S-4	D	1					1
14S-5	Inst.	5					5
14S-6	Inst.	6					6
14S-7	A	3					3
14S-9	A	2					2
14S-10	Inst.	4					4
14S-12	A	3					3
14-3	A	1			1		
16S-1	A	7					7
16S-3	B	1					1
16S-4	D	2					2
16S-5	A	3					3
16S-6	A	3					3
16S-8	A	5					5
16-2	E	1				1	
16-7	A	3			1		2
16-9	A	4				2	2
16-10	A	3				3	
16-11	A	2				2	
16-12	A	1		1			
16-13	A	2				2	
18-1	A/Inst.	10					10
18-3	D	2				2	
18-4	D	4					4
18-5	D	3				2	1
18-6	D	1		1			
18-7	B	1			1		
18-8	A	8				1	7
18-9	Inst.	7				2	5
18-10	A	4				4	
18-11	A	5				5	
18-12	A	6					6
18-13	A	4			1	3	
18-14	A	2		1			1
18-15	A	4				4	
18-16	C	1				1	
18-17	Inst.	7				2	5
18-19	A	10					10
18-20	A	5					5
18-22	D	3					3
18-24	A/Inst.	10					10
18-29	A	5					5
18-30	A	5					5
18-31	A	5					5
20-3	D	3				3	
20-4	D	4				4	
20-6	D	3					3
20-7	D/A	8					8
20-8	Inst.	6			2		4

Insert Arrangement	Service Rating	Total Contacts	Contact Size				
			0	4	8	12	16
20-9	D/A	8				1	7
20-11	Inst.	13					13
20-12	A	2		1			1
20-14	A	5			2	3	
20-15	A	7				7	
20-16	A	9				2	7
20-17	A	6				5	1
20-18	A	9				3	6
20-19	A	3			3		
20-20	A	4		1		3	
20-21	A	9				1	8
20-22	A	6			3		3
20-23	A	2			2		
20-24	A	4			2		2
20-25	Inst.	13					13
20-27	A	14					14
20-29	A	17					17
20-30	Inst.	13					13
20-33	A	11					11
22-1	D	2			2		
22-2	D	3			3		
22-4	A	4			2	2	
22-5	D	6				2	4
22-6	D	3			2		1
22-7	E	1	1				
22-8	E	2				2	
22-9	E	3				3	
22-10	E	4					4
22-11	B	2					2
22-12	D	5			2		3
22-13	D/A	5				4	1
22-14	A	19					19
22-15	E/A	6				5	1
22-16	A	9				3	6
22-17	D/A	9				1	8
22-18	D/A	8					8
22-19	A	14					14
22-20	A	9					9
22-21	A	3	1				2
22-22	A	4			4		
22-23	D/A	8				8	
22-24	D/A	6				2	4
22-27	D/A	9			1		8
22-28	A	7				7	
22-33	D/A	7					7
22-34	D	5				3	2
24-2	D	7				7	
24-3	D	7				2	5
24-5	A	16					16
24-6	D/A	8				8	
24-7	A	16				2	14
24-9	A	2		2			
24-10	A	7			7		
24-11	A	9			3	6	
24-12	A	5		2		3	
24-16	D/A	7			1	3	3
24-17	D	5				2	3

* 10SL-4 arrangement available only with pin contacts in receptacle and socket contacts in plug

MS/Standard

insert arrangements, cont.

Insert Arrangement	Service Rating	Total Contacts	Contact Size				
			0	4	8	12	16
24-20	D	11				2	9
24-21	D	10			1		9
24-22	D	4			4		
24-27	E	7					7
24-28	Inst.	24					24
28-1	D/A	9			3	6	
28-2	D	14				2	12
28-3	E	3			3		
28-4	E/D	9				2	7
28-5	D	5		2		1	2
28-6	D	3		3			
28-7	D	2		2			
28-8	E/D/A	12				2	10
28-9	D	12				6	6
28-10	D/A	7		2	2	3	
28-11	A	22				4	18
28-12	A	26					26
28-13	A	26					26
28-15	A	35					35
28-16	A	20					20
28-17	B/D/A	15					15
28-18	C/D/A/Inst.	12					12
28-19	B/D/A	10				4	6
28-20	A	14				10	4
28-21	A	37					37
28-22	D	6		3			3
32-1	E/D	5	2			3	
32-2	E	5		3			2
32-3	D	9	1	2		2	4
32-4	A/D	14				2	12
32-5	D	2	2				
32-6	A	23		2	3	2	16

Insert Arrangement	Service Rating	Total Contacts	Contact Size				
			0	4	8	12	16
32-7	Inst./A	35				7	28
32-8	A	30				6	24
32-9	D	14		2			12
32-10	E/B/D/A	7		2	2		3
32-12	A/D	15				5	10
32-13	D	23				5	18
32-15	D	8	2			6	
32-16	A	23		2	3	2	16
32-17	D	4		4			
36-1	D	22				4	18
36-3	D	6	3			3	
36-4	D/A	3	3				
36-5	A	4	4				
36-6	A	6	2	4			
36-7	A	47				7	40
36-8	A	47				1	46
36-9	A	31		1	2	14	14
36-10	A	48					48
36-11	A	48					48
36-12	A	48					48
36-13	E/A	17				2	15
36-14	D	16			5	5	6
36-15	D/A	35					35
36-16	A	47				7	40
36-17	A	47				7	40
36-18	A	31		1	2	14	14
36-20	A	34			2	2	30
36-52	A	52					52
40-1	D	30				6	24
40-9	A	47			1	22	24
40-56	A	85					85
48-62	D	85					85

MS/Standard insert alternate positioning

To avoid cross-plugging problems in applications requiring the use of more than one connector of the same size and arrangement, alternate insert rotations are available as indicated in the accompanying chart.

As shown in the diagram below, the front face of the pin insert is rotated within the shell in a clockwise direction from the normal shell key. The socket insert would be rotated counterclockwise the same number of degrees in respect to the normal shell key.

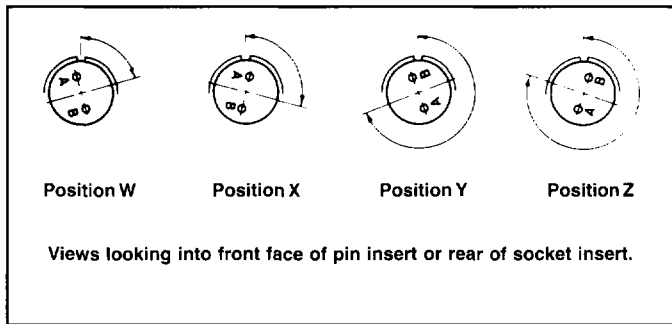

The following insert arrangements have the same alternate insert rotations for W, X, Y and Z which are:

Degrees			
W	X	Y	Z
80	110	250	280

16-7	20-16	22-18	24-4	24-21	28-15	32-6
18-5	20-20	22-19	24-5	24-28	28-16	32-9
18-9	20-22	22-21	24-6	28-1	28-17	32-10
18-13	22-3	22-24	24-7	28-4	28-19	32-12
18-14	22-6	22-25	24-12	28-8	28-20	32-13
20-7	22-12	22-29	24-14	28-9	28-21	36-1
20-8	22-14	22-33	24-16	28-10	32-1	36-7
20-9	22-15	22-34	24-17	28-11	32-3	36-8
20-12	22-16	24-1	24-20	28-14	32-4	36-13
20-14	22-17	24-3				

Insert Arrangement	Degrees			
	W	X	Y	Z
12S-3	70	145	215	290
14S-2	—	120	240	—
14S-5	—	110	—	—
14S-7	90	180	270	—
14S-9	70	145	215	290
16-9	35	110	250	325
16-10	90	180	270	—
16-11	35	110	250	325
16-13	35	110	250	325
16S-1	80	—	—	280
16S-4	35	110	250	325
16S-5	70	145	215	290
16S-6	90	180	270	—
16S-8	—	170	265	—
18-1	70	145	215	290
18-3	35	110	250	325
18-4	35	110	250	325
18-8	70	—	—	290
18-10	—	120	240	—
18-11	—	170	265	—
18-12	80	—	—	280
18-15	—	120	240	—
18-20	90	180	270	—
18-22	70	145	215	290
18-29	90	180	270	—
20-3	70	145	215	290
20-4	45	110	250	—
20-5	35	110	250	325

Insert Arrangement	Degrees			
	W	X	Y	Z
20-6	70	145	215	290
20-15	80	—	—	280
20-17	90	180	270	—
20-18	35	110	250	325
20-19	90	180	270	—
20-21	35	110	250	325
20-23	35	110	250	325
20-24	35	110	250	325
20-27	35	110	250	325
20-29	80	—	—	280
22-1	35	110	250	325
22-2	70	145	215	290
22-4	35	110	250	325
22-5	35	110	250	325
22-8	35	110	250	325
22-9	70	145	215	290
22-10	35	110	250	325
22-11	35	110	250	325
22-13	35	110	250	325
22-20	35	110	250	325
22-22	—	110	250	—
22-23	35	—	250	—
22-27	80	—	250	280
22-28	80	—	—	280
24-2	80	—	—	280
24-9	35	110	250	325
24-10	80	—	—	280
24-11	35	110	250	325

Insert Arrangement	Degrees			
	W	X	Y	Z
24-22	45	110	250	—
24-27	80	—	—	280
28-2	35	110	250	325
28-3	70	145	215	290
28-5	35	110	250	325
28-6	70	145	215	290
28-7	35	110	250	325
28-12	90	180	270	—
28-18	70	145	215	290
28-22	70	145	215	290
32-2	70	145	215	290
32-5	35	110	250	325
32-7	80	125	235	280
32-8	80	125	235	280
32-15	35	110	250	280
32-17	45	110	250	—
36-3	70	145	215	290
36-4	70	145	215	290
36-5	—	120	240	—
36-6	35	110	250	325
36-9	80	125	235	280
36-10	80	125	235	280
36-14	90	180	270	—
36-15	60	125	245	305
40-1	65	130	235	300
40-9	65	125	225	310

MS/Standard contact arrangements

front face of pin insert or rear of socket insert illustrated

			Front of Socket Insert	Front of Socket Insert			
Insert Arrangement	8S-1	10S-2	10SL-3	10SL-4	12S-3	12S-4	12-5
Service Rating	A	A	A	A	A	D	D
Number of Contacts	1	1	3	2	2	1	1
Contact Size	16	16	16	16	16	16	12

Insert Arrangement	14S-2	14S-4	14S-5	14S-6	14S-7	14S-9
Service Rating	Inst.	D	Inst.	Inst.	A	A
Number of Contacts	4	1	5	6	3	2
Contact Size	16	16	16	16	16	16

	100° Rotation of 14S-2	100° Rotation of 14S-7				
Insert Arrangement	14S-10	14S-12	14-3	16S-1	16S-3	16S-4
Service Rating	Inst.	A	A	A	B	D
Number of Contacts	4	3	1	7	1	2
Contact Size	16	16	8	16	16	16

Insert Arrangement	16S-5	16S-6	16S-8	16-2	16-7	16-9
Service Rating	A	A	A	E	A	A
Number of Contacts	3	3	5	1	1 2	2 2
Contact Size	16	16	16	12	8 16	12 16

CONTACT LEGEND	16	12	8	4	0

MS/Standard contact arrangements

front face of pin insert or rear of socket insert illustrated

Insert Arrangement	16-10	16-11	16-12	16-13	18-1	18-3
Service Rating	A	A	A	A	B, C, F, G = A; Bal. = Inst.	D
Number of Contacts	3	2	1	2*	10	2
Contact Size	12	12	4	12	16	12

Insert Arrangement	18-4	18-5	18-6	18-7	18-8	18-9
Service Rating	D	D	D	B	A	Inst.
Number of Contacts	4	2 1	1	1	1 7	2 5
Contact Size	16	12 16	4	8	12 16	12 16

Insert Arrangement	18-10	18-11	18-12	18-13	18-14	18-15
Service Rating	A	A	A	A	A	A
Number of Contacts	4	5	6	1 3	1 1	4**
Contact Size	12	12	16	8 12	4 16	12

Insert Arrangement	18-16	18-17	18-19	18-20	18-22	18-24
Service Rating	C	Inst.	A	A	D	B, C, F, G = A; Bal. = Inst.
Number of Contacts	1	2 5	10	5	3	10
Contact Size	12	12 16	16	16	16	16

*A = Iron, B = Constantan
**A, C = Iron; B, D = Constantan

CONTACT LEGEND

16	12	8	4	0

MS/Standard contact arrangements

front face of pin insert or rear of socket insert illustrated

Insert Arrangement	18-29	110° Rotation of 18-20 18-30	260° Rotation of 18-20 18-31	20-3	20-4	20-6
Service Rating	A	A	A	D	D	D
Number of Contacts	5	5	5	3	4	3
Contact Size	16	16	16	12	12	16

Insert Arrangement	20-7	20-8	20-9	20-11	20-12	20-14
Service Rating	A, B, H, G = D; C, D, E, F = A	Inst.	H = D; Bal. = A	Inst.	A	A
Number of Contacts	8	2 4	1 7	13	1 1	2 3
Contact Size	16	8 16	12 16	16	4 16	8 12

Insert Arrangement	20-15	20-16	20-17	20-18	20-19	20-20
Service Rating	A	A	A	A	A	A
Number of Contacts	7	2 7	5 1	3 6	3	1 3
Contact Size	12	12 16	12 16	12 16	8	4 12

CONTACT LEGEND	16	12	8	4	0

MS/Standard contact arrangements

front face of pin insert or rear of socket insert illustrated

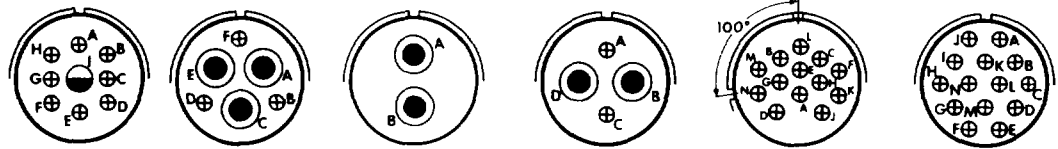

Insert Arrangement	20-21	20-22	20-23	20-24	20-25 100° Rotation of 20-11	20-27
Service Rating	A	A	A	A	Inst.	A
Number of Contacts	1 8	3 3	2	2 2	13	14
Contact Size	12 16	8 16	B	8 16	16	16

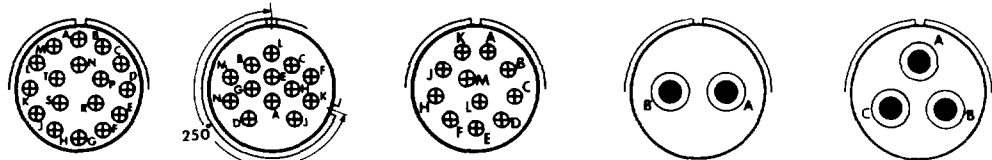

Insert Arrangement	20-29	20-30 250° Rotation of 20-11	20-33	22-1	22-2
Service Rating	A	Inst.	A	D	D
Number of Contacts	17	13	11	2	3
Contact Size	16	16	16	8	8

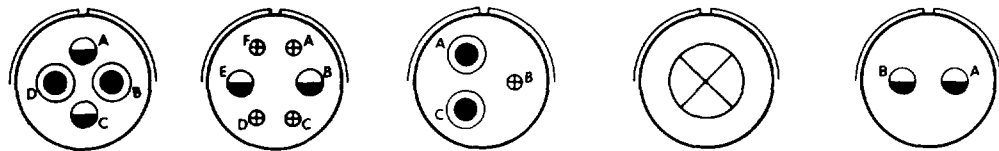

Insert Arrangement	22-4	22-5	22-6	22-7	22-8
Service Rating	A	D	D	E	E
Number of Contacts	2 2	2 4	2 1	1	2
Contact Size	8 12	12 16	8 16	0	12

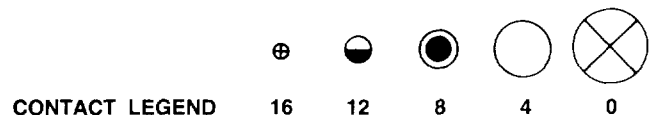

MS/Standard contact arrangements

front face of pin insert or rear of socket insert illustrated

Insert Arrangement	22-9	22-10	22-11	22-12	22-13
Service Rating	E	E	B	D	E = D; A, B, C, D = A
Number of Contacts	3	4	2	2 3	4 1
Contact Size	12	16	16	8 16	12 16

Insert Arrangement	22-14	22-15	22-16	22-17	22-18
Service Rating	A	D = E; A, B, C, E, F = A	A	A = D; Bal. = A	A, B, F, G, H = D; C, D, E = A
Number of Contacts	19	5 1	3 6	1 8	8
Contact Size	16	12 16	12 16	12 16	16

Insert Arrangement	22-19	22-20	22-21	22-22	22-23
Service Rating	A	A	A	A	H = D; Bal. = A
Number of Contacts	14	9	1 2	4	8
Contact Size	16	16	0 16	8	12

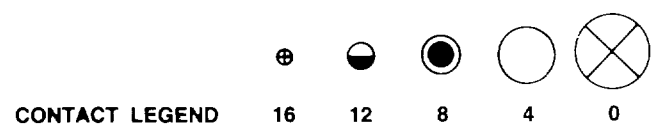

MS/Standard contact arrangements

front face of pin insert or rear of socket insert illustrated

Insert Arrangement	22-24	22-27	22-28	22-33	22-34
Service Rating	C, D, E = D; A, B, F = A	J = D; Bal. = A	A	A, B, C, D, = D; E, F, G = A	D
Number of Contacts	2 4	1 8	7	7	3 2
Contact Size	12 16	8 16	12	16	12 16

Insert Arrangement	24-2	24-3	24-5	24-6	24-7
Service Rating	D	D	A	A, G, H = D; Bal. = A	A
Number of Contacts	7	2 5	16	8	2 14
Contact Size	12	12 16	16	12	12 16

Insert Arrangement	24-9	24-10	24-11	24-12	24-16
Service Rating	A	A	A	A	A, B, F, G = D; C, D, E = A
Number of Contacts	2	7	3 6	2 3	1 3 3
Contact Size	4	8	8 12	4 12	8 12 16

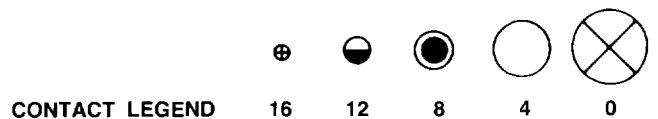

MS/Standard contact arrangements

front face of pin insert or rear of socket insert illustrated

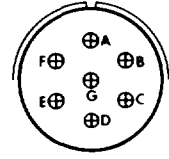
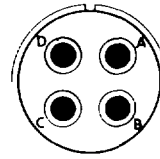
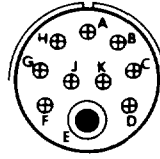
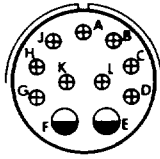
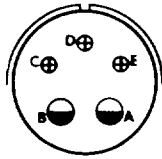

Insert Arrangement	24-17	24-20	24-21	24-22	24-27
Service Rating	D	D	D	D	E
Number of Contacts	2 3	2 9	1 9	4	7
Contact Size	12 16	12 16	8 16	8	16

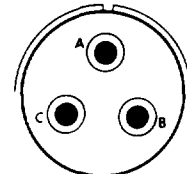
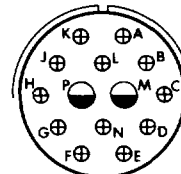
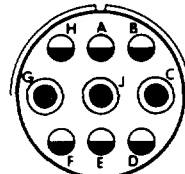
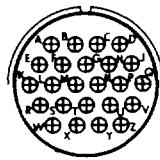

Insert Arrangement	24-28	28-1	28-2	28-3
Service Rating	Inst.	A, J, E = D; Bal. = A	D	E
Number of Contacts	24	3 6	2 12	3
Contact Size	16	8 12	12 16	8

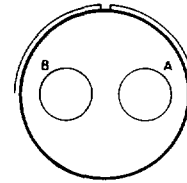
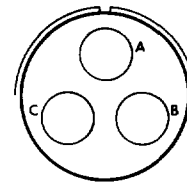
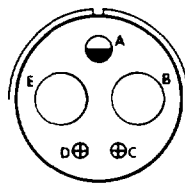
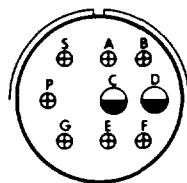

Insert Arrangement	28-4	28-5	28-6	28-7
Service Rating	G, P, S = E; Bal. = D	D	D	D
Number of Contacts	2 7	2 1 2	3	2
Contact Size	12 16	4 12 16	4	4

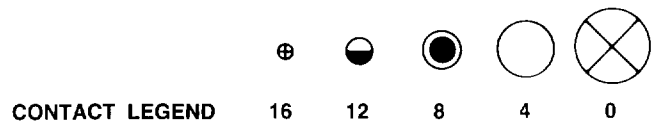

MS/Standard contact arrangements

front face of pin insert or rear of socket insert illustrated

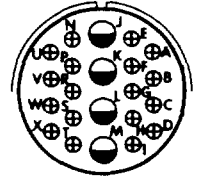
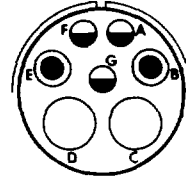
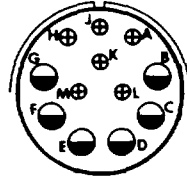
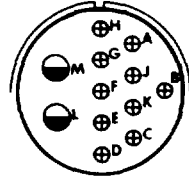

Insert Arrangement	28-8
Service Rating	L, M = E; B = D; Bal. = A
Number of Contacts	2 10
Contact Size	12 16

Insert Arrangement	28-9
Service Rating	D
Number of Contacts	6 6
Contact Size	12 16

Insert Arrangement	28-10
Service Rating	G = D; Bal. = A
Number of Contacts	2 2 3
Contact Size	4 8 12

Insert Arrangement	28-11
Service Rating	A
Number of Contacts	4 18
Contact Size	12 16

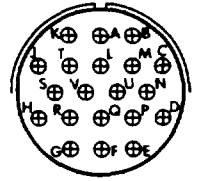
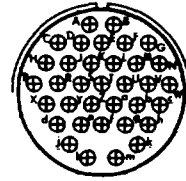
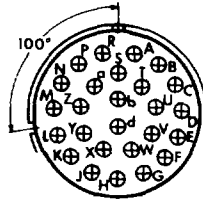
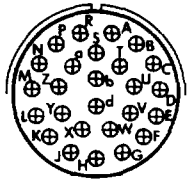

Insert Arrangement	28-12
Service Rating	A
Number of Contacts	26
Contact Size	16

100° Rotation
of 28-12

Insert Arrangement	28-13
Service Rating	A
Number of Contacts	26
Contact Size	16

Insert Arrangement	28-15
Service Rating	A
Number of Contacts	35
Contact Size	16

Insert Arrangement	28-16
Service Rating	A
Number of Contacts	20
Contact Size	16

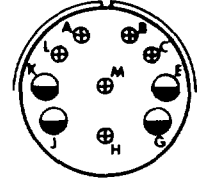
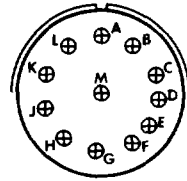
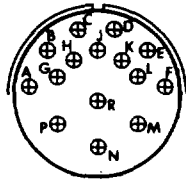

Insert Arrangement	28-17
Service Rating	R = B; M, N, P = D; A to L = A
Number of Contacts	15
Contact Size	16

Insert Arrangement	28-18
Service Rating	M = C; G, H, J, K, L = D; A, B = A, Bal. = Inst.
Number of Contacts	12
Contact Size	16

Insert Arrangement	28-19
Service Rating	H, M = B; A, B = D; Bal = A
Number of Contacts	4 6
Contact Size	12 16



CONTACT LEGEND 16 12 8 4 0

MS/Standard contact arrangements

front face of pin insert or rear of socket insert illustrated

Insert Arrangement	28-20	28-21	28-22	32-1
Service Rating	A	A	D	A = E; B, C, D, E = D
Number of Contacts	10 4	37	3 3	2 3
Contact Size	12 16	16	4 16	0 12

Insert Arrangement	32-2	32-3	32-4	32-5
Service Rating	E	D	F, J, K, N = A; Bal. = D	D
Number of Contacts	3 2	1 2 2 4	2 12	2
Contact Size	4 16	0 4 12 16	12 16	0

Insert Arrangement	32-6	32-7	32-8	32-9
Service Rating	A	A, B, h, j = Inst.; Bal. = A	A	D
Number of Contacts	2 3 2 16	7 28	6 24	2 12
Contact Size	4 8 12 16	12 16	12 16	4 16

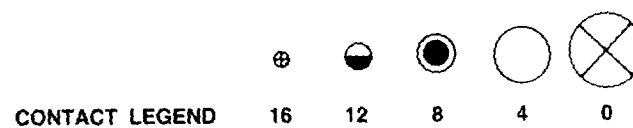

MS/Standard contact arrangements

front face of pin insert or rear of socket insert illustrated

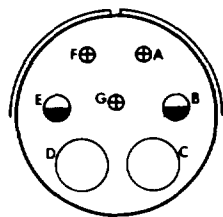

32-10
 A, F = E; G = B; B, E = D; C, D = A
 2 2 3
 4 8 16

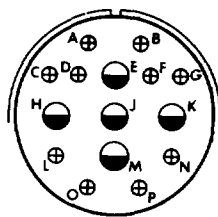

32-12
 C, D, E, F, G = A; Bal. = D
 5 10
 12 16

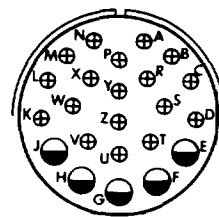

32-13
 D
 5 18
 12 16

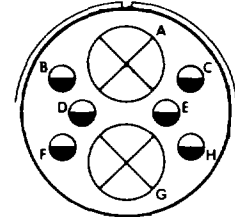

32-15
 D
 2 6
 0 12

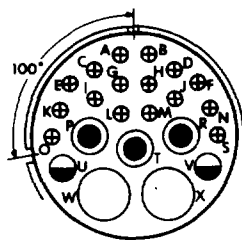

100° Rotation
 of 32-6

32-16
 A
 2 3 2 16
 4 8 12 16

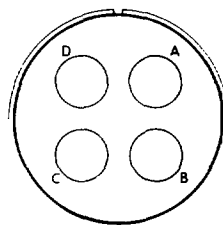

32-17
 D
 4
 4

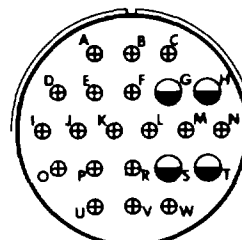

36-1
 D
 4 18
 12 16

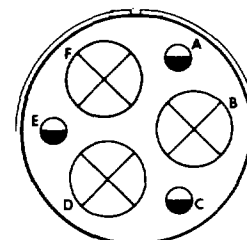

36-3
 D
 3 3
 0 12

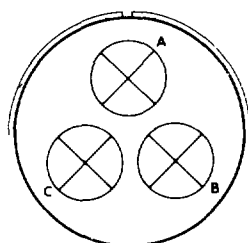

36-4
 A = D; B, C = A
 3
 0

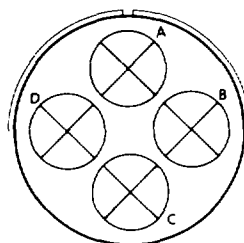

36-5
 A
 4
 0

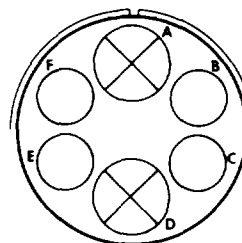

36-6
 A
 2 4
 0 4

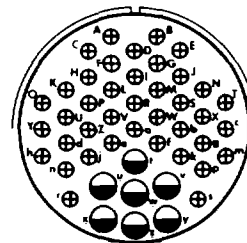

36-7
 A
 7 40
 12 16

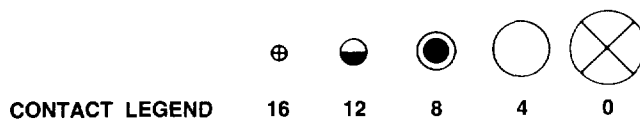

MS/Standard contact arrangements

front face of pin insert or rear of socket insert illustrated

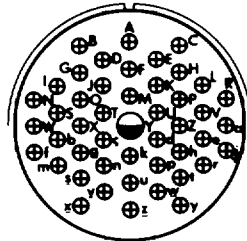

36-8
A
1 46
12 16

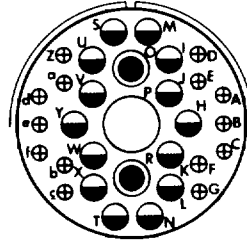

36-9
A
1 2 14 14
4 8 12 16

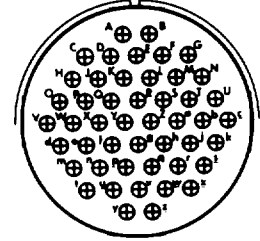

36-10
A
48
16

Insert Arrangement
Service Rating
Number of Contacts
Contact Size

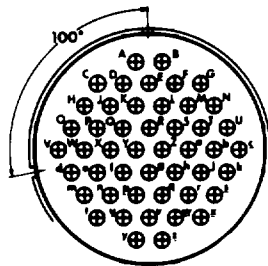

100° Rotation
of 36-10
36-11
A
48
16

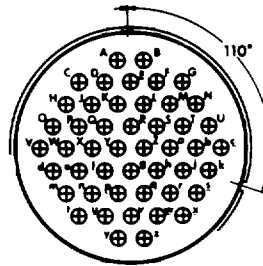

110° Rotation
of 36-10
36-12
A
48
16

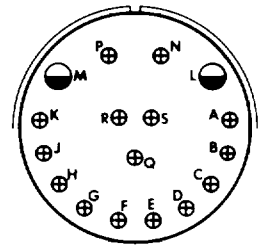

36-13
N, P, Q = E; Bal. = A
2 15
12 16

Insert Arrangement
Service Rating
Number of Contacts
Contact Size

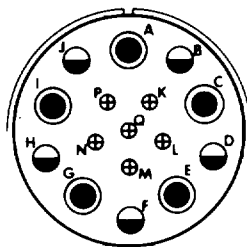

36-14
D
5 5 6
8 12 16

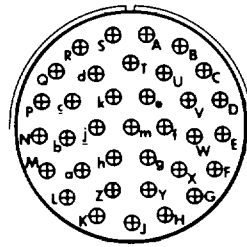

36-15
M = D; Bal. = A
35
16

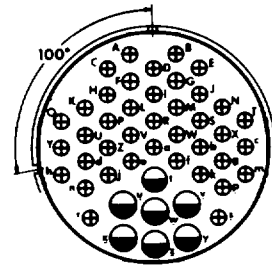

100° Rotation
of 36-7
36-16
A
7 40
12 16

Insert Arrangement
Service Rating
Number of Contacts
Contact Size



CONTACT LEGEND

16 12 8 4 0

MS/Standard contact arrangements

front face of pin insert or rear of socket insert illustrated

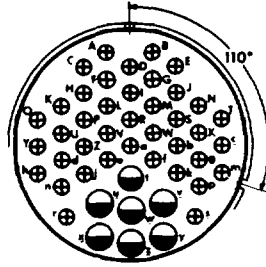

110° Rotation of 36-7

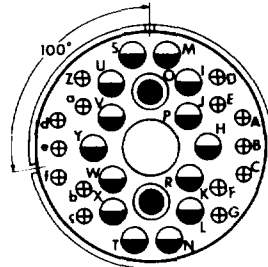

100° Rotation of 36-9

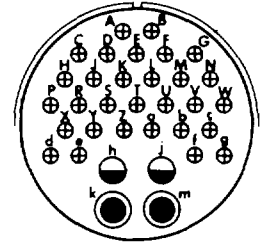

Insert Arrangement
Service Rating
Number of Contacts
Contact Size

36-17
A
7 40
12 16

36-18
A
1 2 14 16
4 8 12 16

36-20
A
2 2 30
8 12 16

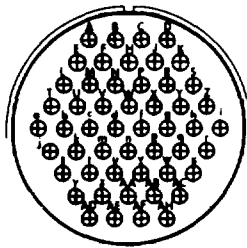

36-52
A
52
16

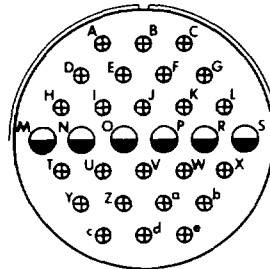

40-1
D
6 24
12 16

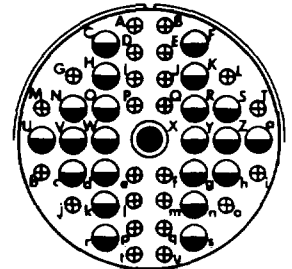

40-9
A
1 22 24
8 12 16

Insert Arrangement
Service Rating
Number of Contacts
Contact Size

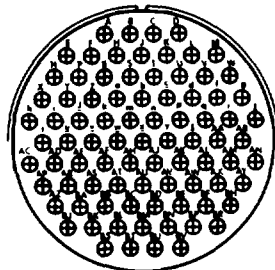

40-56
A
85
16

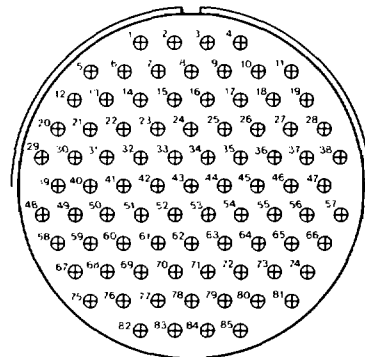

48-62
D
85
16

Insert Arrangement
Service Rating
Number of Contacts
Contact Size



CONTACT LEGEND 16 12 8 4 0

X-ON Electronics

Largest Supplier of Electrical and Electronic Components

Click to view similar products for [Circular MIL Spec Connector](#) category:

Click to view products by [Amphenol](#) manufacturer:

Other Similar products are found below :

[89075GULPR](#) [0025-262-542](#) [0025-264-3014](#) [58-570121-04S](#) [0134-213-1208](#) [0134-213-2209](#) [0025-258-000](#) [60-042022-07P](#) [60-042022-19P](#)
[60-042022-23P](#) [60-042217-10P](#) [0114-201-1278](#) [012-0467-000](#) [602GB06EG24-61SN](#) [0134-201-1207](#) [0134-213-1006](#) [6104-207-2302](#) [6104-](#)
[208-1902](#) [61-168211-04P](#) [61-168617-10P](#) [6131-202-19149P](#) [6131-204-21149P](#) [6131-208-13149P](#) [6131-209-17149P](#) [6131-210-11149P](#) [6131-](#)
[211-19149P](#) [6131-216-19149P](#) [6131-259-21149P](#) [6131-259-23149P](#) [6131-265-17149P](#) [6131-265-19149P](#) [CS3100A18-1P-472](#) [CS3100A-36-](#)
[77P](#) [CS3101A-16-55P](#) [CS3102A-10SL-55P](#) [CS3102A-14S-58P](#) [CS3102A-32-17P](#) [CS3102A32-25S](#) [CS3102C18-4P-472](#)
[CS3106A10SL3S004](#) [CS3106A-18-73S](#) [CS3108A-14S-52S](#) [CS3108A-28-51S](#) [6162-233-1277](#) [6162-324-1231](#) [M243082296Z](#)
[M2884010AC1S1](#) [CT0-24-10SC](#) [CT0M20-7PCAU](#) [M28840/17AC1G3](#)