

# Film Capacitors

## Metallized Polypropylene Film Capacitors (MKP)

**Series/Type:** B32754 ... B32758

**Date:** June 2018

© EPCOS AG 2018. Reproduction, publication and dissemination of this publication, enclosures hereto and the information contained therein without EPCOS' prior express consent is prohibited.

EPCOS AG is a TDK Group Company.

**MKP AC filtering**
**Typical applications**

- Output AC filtering for power converters, UPS, motor drives

**Climatic**

- Max. operating temperature: 105 °C
- Climatic category (IEC 60068-1:2013): 40/85/56

**Construction**

- Dielectric: Polypropylene (PP)
- Plastic case (UL 94 V-0)
- Epoxy resin sealing (UL 94 V-0)

**Features**

- Optimized AC voltage performance
- High ripple current/frequency handling capability
- For PCB mounting
- AEC-Q200D compliant

**Terminals**

- Parallel wire leads, lead-free tinned
- 2-pin and 4-pin versions
- Standard lead lengths: 6 – 1 mm
- Special lead lengths available on request

**Marking**

Manufacturer's logo, lot number, series number, rated capacitance (code), capacitance tolerance (code with letter), rated AC voltage, date of manufacture (code)

**Delivery mode**

Bulk (untaped, lead length 6 – 1 mm)

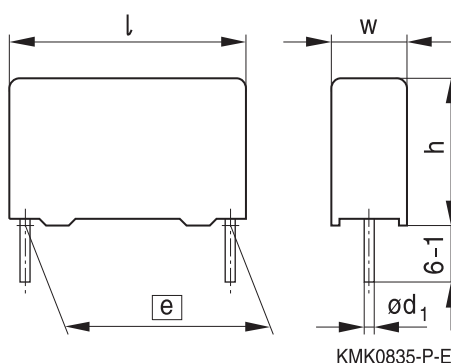
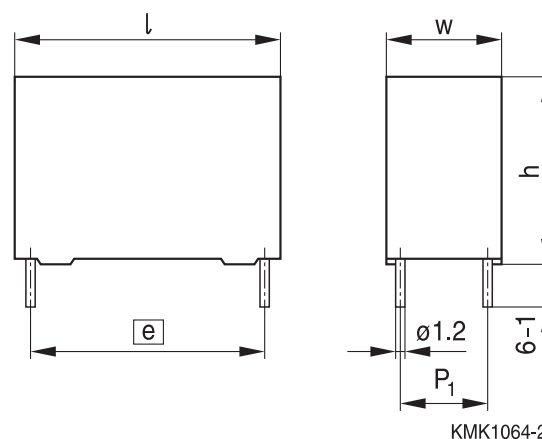
**Dimensional drawings**
**2-pin version**

**4-pin version**

Dimensions in mm

Version	Lead spacing $e \pm 0.4$	Lead diameter $d_1 \pm 0.05$	Type
2-pin	27.5	0.8	B32754C
2-pin	37.5	1.0	B32756C
4-pin	37.5	1.0 <sup>1)</sup> /1.2	B32756G
4-pin	52.5	1.2	B32758G

1) For box dimensions 22.0 × 45.0 × 42.0 mm



### Overview of available types

Lead spacing	27.5 mm			37.5 mm			52.5 mm		
Type	B32754			B32756			B32758		
Page	4			5			7		
$V_{RMS}$ (V AC)	250	275	310	250	275	310	250	275	310
$C_R$ ( $\mu$ F)									
1.0									
1.5									
2.0									
2.5									
3.0									
3.5									
4.0									
4.5									
5.0									
6.0									
7.0									
8.0									
9.0									
10									
12									
14									
15									
20									
22									
25									
30									
35									
40									
45									
50									
55									
60									
65									
70									

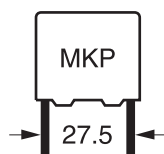
**B32754**
**MKP AC filtering**
**Ordering codes and packing units (lead spacing 27.5 mm)**

$V_{RMS}$	$V_R$	$C_R$	Max. dimensions $w \times h \times l$	$P_1$	Ordering code (composition see below)	$I_{RMS}$ 70 °C 10 kHz A	$ESR_{typ}$ 10 kHz mΩ	Untaped pcs./MOQ
V AC	V DC	μF	mm	mm				
250	500	1.0	11.0 × 19.0 × 31.5	—	B32754C2105+000	2.5	26.8	2352
		2.0	12.5 × 21.5 × 31.5	—	B32754C2205+000	4.0	15.1	2100
		3.0	14.0 × 24.5 × 31.5	—	B32754C2305K000	5.0	10.5	1848
		4.0	16.0 × 32.0 × 31.5	—	B32754C2405+000	6.4	7.3	1064
		5.0	16.0 × 32.0 × 31.5	—	B32754C2505+000	7.0	6.9	1064
		6.0	18.0 × 33.0 × 31.5	—	B32754C2605+000	7.5	6.0	952
		7.0	22.0 × 36.5 × 31.5	—	B32754C2705+000	8.0	5.2	784
		8.0	22.0 × 36.5 × 31.5	—	B32754C2805+000	9.0	4.9	784
		9.0	22.0 × 36.5 × 31.5	—	B32754C2905+000	11.0	4.5	784
		10.0	22.0 × 36.5 × 31.5	—	B32754C2106K000	12.0	4.2	784
275	560	1.0	11.0 × 19.0 × 31.5	—	B32754C7105+000	2.5	26.8	2352
		1.5	12.5 × 21.5 × 31.5	—	B32754C7155+000	3.8	18.1	2100
		2.0	13.5 × 23.0 × 31.5	—	B32754C7205+000	4.5	13.8	1932
		2.5	15.0 × 24.5 × 31.5	—	B32754C7255+000	5.0	11.3	1680
		3.0	16.0 × 32.0 × 31.5	—	B32754C7305+000	6.0	8.7	1064
		4.0	18.0 × 33.0 × 31.5	—	B32754C7405+000	7.0	6.8	952
		5.0	18.0 × 33.0 × 31.5	—	B32754C7505K000	8.0	6.0	952
		6.0	22.0 × 36.5 × 31.5	—	B32754C7605+000	9.0	4.9	784
7.0	22.0 × 36.5 × 31.5	—	B32754C7705+000	10.0	4.6	784		
310	630	1.0	11.0 × 21.0 × 31.5	—	B32754C3105+000	3.0	24.6	2352
		1.5	13.5 × 23.0 × 31.5	—	B32754C3155+000	3.8	16.7	1932
		2.0	14.0 × 24.5 × 31.5	—	B32754C3205K000	5.0	12.8	1848
		2.5	16.0 × 32.0 × 31.5	—	B32754C3255K000	5.2	10.3	1064
		3.0	18.0 × 27.5 × 31.5	—	B32754C3305+000	6.5	8.9	1428
		3.5	18.0 × 33.0 × 31.5	—	B32754C3355+000	7.0	7.6	952
		4.0	19.0 × 30.0 × 31.5	—	B32754C3405K000	7.5	7.0	896
		4.5	21.0 × 31.0 × 31.5	—	B32754C3455+000	8.5	6.0	784
		5.0	22.0 × 36.5 × 31.5	—	B32754C3505+000	9.0	5.6	784
		6.0	22.0 × 36.5 × 31.5	—	B32754C3605K000	10.0	4.8	784

MOQ = Minimum Order Quantity, consisting of 4 packing units.  
Further E series and intermediate capacitance values on request.

**Composition of ordering code**

+ = Capacitance tolerance code:

K = ±10%

J = ±5%

**Ordering codes and packing units (lead spacing 37.5 mm)**

$V_{RMS}$	$V_R$	$C_R$	Max. dimensions $w \times h \times l$	$P_1$	Ordering code (composition see below)	$I_{RMS}$ 70 °C 10 kHz A	$ESR_{typ}$ 10 kHz mΩ	Untaped pcs./MOQ
V AC	V DC	μF	mm	mm				
250	500	5.0	18.0 × 32.5 × 42.0	—	B32756C2505+000	7.0	12.5	720
		6.0	18.0 × 32.5 × 42.0	—	B32756C2605+000	7.0	10.6	720
		7.0	18.0 × 32.5 × 42.0	—	B32756C2705+000	7.0	10.0	720
		8.0	18.0 × 32.5 × 42.0	—	B32756C2805+000	8.3	9.7	720
		9.0	18.0 × 32.5 × 42.0	—	B32756C2905+000	8.5	8.7	720
		10	20.0 × 39.5 × 42.0	10.2	B32756G2106+000	10.0	6.8	640
		12	20.0 × 39.5 × 42.0	10.2	B32756G2126+000	11.0	6.3	640
		15	22.0 × 45.0 × 42.0	10.2	B32756G2156+000	12.0	5.2	560
		20	28.0 × 42.5 × 42.0	10.2	B32756G2206+000	14.0	4.0	440
		22	30.0 × 45.0 × 42.0	20.3	B32756G2226+000	16.0	3.7	400
		25	33.0 × 48.0 × 42.0	20.3	B32756G2256+000	17.0	3.3	180
		30	33.0 × 48.0 × 42.0	20.3	B32756G2306K000	18.0	3.0	180
275	560	5.0	18.0 × 32.5 × 42.0	—	B32756C7505+000	7.0	12.5	720
		6.0	18.0 × 32.5 × 42.0	—	B32756C7605+000	7.0	10.6	720
		7.0	18.0 × 32.5 × 42.0	—	B32756C7705+000	8.0	10.0	720
		8.0	20.0 × 39.5 × 42.0	10.2	B32756G7805+000	9.0	7.7	640
		9.0	20.0 × 39.5 × 42.0	10.2	B32756G7905+000	10.0	6.9	640
		10	20.0 × 39.5 × 42.0	10.2	B32756G7106+000	11.0	6.8	640
		12	22.0 × 45.0 × 42.0	10.2	B32756G7126+000	12.0	5.7	560
		15	28.0 × 42.5 × 42.0	10.2	B32756G7156+000	14.0	4.7	440
		20	30.0 × 45.0 × 42.0	20.3	B32756G7206K000	17.0	3.6	400
		22	33.0 × 48.0 × 42.0	20.3	B32756G7226+000	18.0	3.4	180

MOQ = Minimum Order Quantity, consisting of 4 packing units.  
Further E series and intermediate capacitance values on request.

**Composition of ordering code**

+ = Capacitance tolerance code:

K = ±10%

J = ±5%

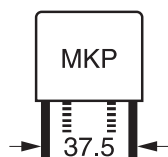

**B32756**

**MKP AC filtering**

**Ordering codes and packing units (lead spacing 37.5 mm)**

$V_{RMS}$	$V_R$	$C_R$	Max. dimensions $w \times h \times l$	$P_1$	Ordering code (composition see below)	$I_{RMS}$ 70 °C 10 kHz A	$ESR_{typ}$ 10 kHz mΩ	Untaped pcs./MOQ
V AC	V DC	μF	mm	mm				
310	630	5.0	18.0 × 32.5 × 42.0	—	B32756C3505+000	7.0	12.5	720
		6.0	18.0 × 32.5 × 42.0	—	B32756C3605+000	9.0	10.5	720
		7.0	20.0 × 39.5 × 42.0	10.2	B32756G3705+000	10.0	8.7	640
		8.0	20.0 × 39.5 × 42.0	10.2	B32756G3805+000	11.0	7.7	640
		9.0	20.0 × 39.5 × 42.0	10.2	B32756G3905K000	11.0	6.9	640
		10	22.0 × 45.0 × 42.0	10.2	B32756G3106+000	12.0	6.2	560
		12	22.0 × 45.0 × 42.0	10.2	B32756G3126K000	12.5	5.3	560
		14	28.0 × 42.5 × 42.0	10.2	B32756G3146K000	13.5	4.7	440
		15	30.0 × 45.0 × 42.0	20.3	B32756G3156+000	16.0	4.3	400
		20	33.0 × 48.0 × 42.0	20.3	B32756G3206K000	17.0	3.6	180

MOQ = Minimum Order Quantity, consisting of 4 packing units.  
Further E series and intermediate capacitance values on request.

**Composition of ordering code**

+ = Capacitance tolerance code:  
K = ±10%  
J = ±5%

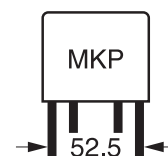
**Ordering codes and packing units (lead spacing 52.5 mm)**

$V_{RMS}$	$V_R$	$C_R$	Max. dimensions $w \times h \times l$	$P_1$	Ordering code (composition see below)	$I_{RMS}$ 70 °C 10 kHz A	$ESR_{typ}$ 10 kHz mΩ	Untaped pcs./MOQ
V AC	V DC	μF	mm	mm				
250	500	20	30.0 × 45.0 × 57.5	20.3	B32758G2206+000	13.0	6.2	280
		22	30.0 × 45.0 × 57.5	20.3	B32758G2226+000	13.0	5.7	280
		25	30.0 × 45.0 × 57.5	20.3	B32758G2256+000	14.0	5.6	280
		30	30.0 × 45.0 × 57.5	20.3	B32758G2306+000	16.0	5.2	280
		35	30.0 × 45.0 × 57.5	20.3	B32758G2356K000	17.0	4.5	280
		40	35.0 × 50.0 × 57.5	20.3	B32758G2406+000	20.0	4.0	108
		45	35.0 × 50.0 × 57.5	20.3	B32758G2456K000	21.0	3.6	108
		50	38.0 × 57.5 × 57.5	20.3	B32758G2506+000	22.0	3.4	96
		55	38.0 × 57.5 × 57.5	20.3	B32758G2556+000	24.0	3.1	96
		60	38.0 × 57.5 × 57.5	20.3	B32758G2606K000	25.0	3.0	96
		65	45.0 × 57.0 × 57.5	20.3	B32758G2656+000	26.0	2.7	140
275	560	20	30.0 × 45.0 × 57.5	20.3	B32758G7206+000	13.0	6.2	280
		22	30.0 × 45.0 × 57.5	20.3	B32758G7226+000	14.0	5.7	280
		25	30.0 × 45.0 × 57.5	20.3	B32758G7256+000	16.0	5.6	280
		30	35.0 × 50.0 × 57.5	20.3	B32758G7306+000	17.0	4.5	108
		35	35.0 × 50.0 × 57.5	20.3	B32758G7356+000	20.0	4.1	108
		40	38.0 × 57.5 × 57.5	20.3	B32758G7406+000	21.0	3.7	96
		45	38.0 × 57.5 × 57.5	20.3	B32758G7456+000	23.0	3.4	96
		50	45.0 × 57.0 × 57.5	20.3	B32758G7506+000	24.0	3.1	140
		55	45.0 × 57.0 × 57.5	20.3	B32758G7556K000	25.0	2.8	140

MOQ = Minimum Order Quantity, consisting of 4 packing units.  
Further E series and intermediate capacitance values on request.

**Composition of ordering code**

+ = Capacitance tolerance code:

K = ±10%

J = ±5%



**B32758**

**MKP AC filtering**

**Ordering codes and packing units (lead spacing 52.5 mm)**

$V_{RMS}$	$V_R$	$C_R$	Max. dimensions $w \times h \times l$	$P_1$	Ordering code (composition see below)	$I_{RMS}$ 70 °C 10 kHz A	$ESR_{typ}$ 10 kHz mΩ	Untaped pcs./MOQ
V AC	V DC	μF	mm	mm				
310	630	20	30.0 × 45.0 × 57.5	20.3	B32758G3206+000	15.0	6.2	280
		22	30.0 × 45.0 × 57.5	20.3	B32758G3226+000	16.5	5.7	280
		25	35.0 × 50.0 × 57.5	20.3	B32758G3256+000	18.0	5.1	108
		30	35.0 × 50.0 × 57.5	20.3	B32758G3306+000	21.0	4.3	108
		35	38.0 × 57.5 × 57.5	20.3	B32758G3356+000	22.0	3.8	96
		40	38.0 × 57.5 × 57.5	20.3	B32758G3406K000	24.0	3.4	96
		45	45.0 × 57.0 × 57.5	20.3	B32758G3456K000	26.0	3.1	140

MOQ = Minimum Order Quantity, consisting of 4 packing units.  
Further E series and intermediate capacitance values on request.

**Composition of ordering code**

+ = Capacitance tolerance code:

K = ±10%

J = ±5%





## Technical data

Reference standard: IEC 60384-14:2013/AMD1:2016, Grade III A and AEC-Q200D. All data given at T = 20 °C, unless otherwise specified.

Operating temperature range (case)	Max. operating temperature, $T_{op,max}$ +105 °C Upper category temperature $T_{max}$ +85 °C Lower category temperature $T_{min}$ -40 °C Note: At T > 85 °C derating for $V_{RMS}$ (V AC) should be 1.5%/°C
Dissipation factor $\tan \delta$ (in $10^{-3}$ ) at 20 °C (upper limit values)	1.0 (1 kHz)
Insulation resistance $R_{ins}$ after 1min, given as time constant $\tau = C_R \cdot R_{ins}$ , rel. humidity $\leq 65\%$ (minimum as-delivered values) Measuring voltage: 500 V DC	10 000 s
Test voltage between terminals	$1.5 \cdot V_R$ for 10 s
DC Test voltage terminal to case	2000 V AC at 50 Hz, 10 s
Self-inductance (LS)	< 1 nH per mm of lead spacing
Maximum peak current (A)	$I_{P,max} = C_R \cdot \frac{dV}{dt}$
Damp heat test Limit values after damp heat test	1. 56 days/40 °C/93% relative humidity Capacitance change $ \Delta C/C  \leq 5\%$ Dissipation factor change $\Delta \tan \delta \leq 1.5 \cdot 10^{-3}$ (at 1 kHz) Insulation resistance $R_{ins} \geq 50\%$ of minimum as-delivered values  2. 1344 hours/60 °C/95% relative humidity $V_{R, AC}$ Capacitance change $ \Delta C/C  \leq 10\%$ Dissipation factor change $\Delta \tan \delta \leq 5 \cdot$ upper limit values Insulation resistance $R_{ins} \geq 50\%$ of minimum as-delivered values
Change of temperature	In accordance with IEC 60068-2-14 (Test Nb)
Reliability: Failure rate $\lambda$ Service life $t_{SL}$  Failure criteria: Total failure Failure due to variation of parameters	10 fit ( $\leq 10 \times 10^{-9}/h$ ) at $0.5 \times U_N$ , 40 °C > 60 000 h at $0.9 V_R$ , 70 °C For conversion to other operating conditions and temperatures, refer to chapter "Quality, 2 Reliability".  Short/open circuit Capacitance change $ \Delta C/C  \geq 10\%$ Dissipation factor change $\Delta \tan \delta > 4 \cdot$ upper limit values Insulation resistance $R_{ins}$ or time constant $\tau = C_R \cdot R_{ins} < 500$ s



**B32754 ... B32758**

**MKP AC filtering**

### Pulse handling capability

"dV/dt" represents the maximum permissible voltage change per unit of time for non-sinusoidal voltages, expressed in V/μs.

"k0" represents the maximum permissible pulse characteristic of the waveform applied to the capacitor, expressed in V<sup>2</sup>/μs.

*Note:*

*The values of dV/dt and k0 provided below must not be exceeded in order to avoid damaging the capacitor. These parameters are given for isolated pulses in such a way that the heat generated by one pulse will be completely dissipated before applying the next pulse. For a train of pulses, please refer to the curves of permissible AC voltage-current versus frequency*

Lead spacing	27.5 mm			37.5 mm			52.5 mm		
Type	B32754			B32756			B32758		
V <sub>R</sub> (V DC)	500	560	630	500	560	630	500	560	630
V <sub>RMS</sub> (V AC)	250	275	310	250	275	310	250	275	310
	dV/dt in V/μs								
	50	55	68	25	30	35	13	15	17

### Impedance Z versus frequency f

(typical values)

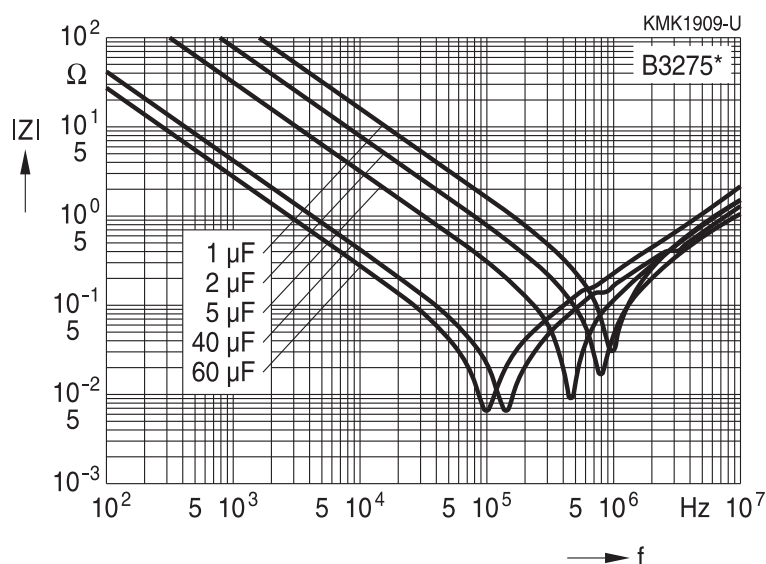

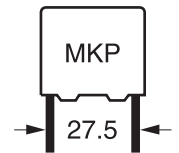

**Permissible AC voltage  $V_{RMS}$  versus frequency  $f$  (for sinusoidal waveforms,  $T_{op} \leq 85^\circ C$ )**

For  $T_{op} > 85^\circ C$ , please refer to derating curve. The maximum component surface temperature must be lower than  $105^\circ C$  and maximum temperature rise between case and free ambient shall be lower than  $15^\circ C$ .

**Lead spacing 27.5 mm**

500 V DC/250 V AC

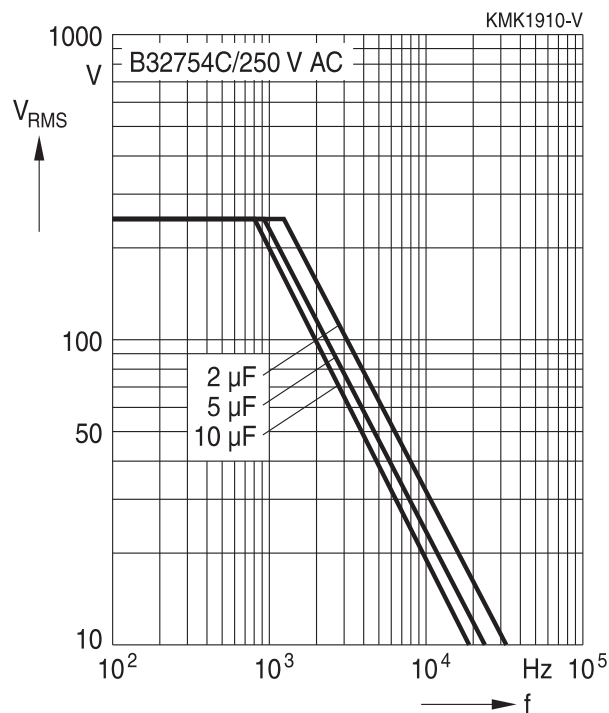

560 V DC/275 V AC

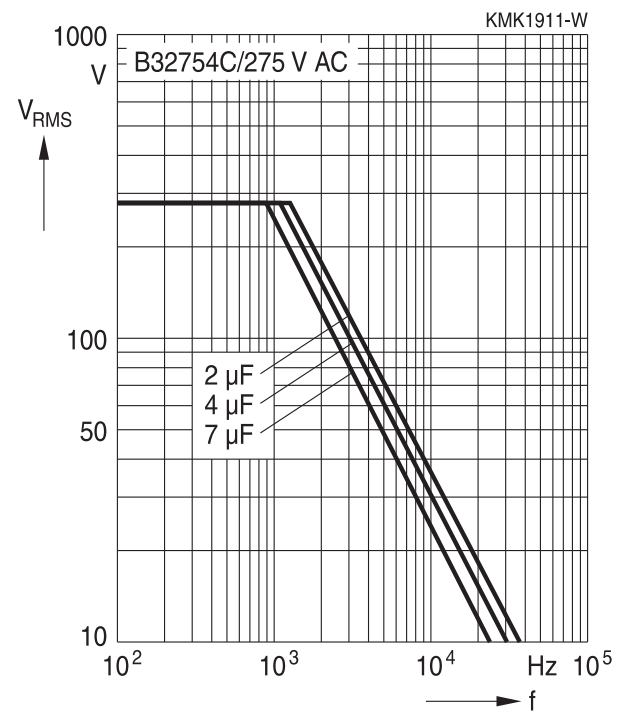

630 V DC/310 V AC

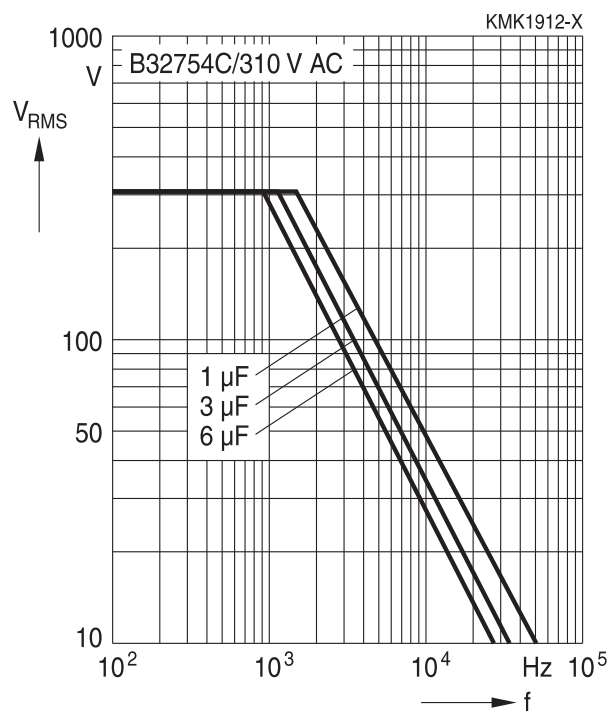

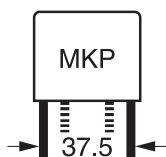

**B32756**

**MKP AC filtering**

**Permissible AC voltage  $V_{RMS}$  versus frequency  $f$  (for sinusoidal waveforms,  $T_{op} \leq 85^\circ C$ )**

For  $T_{op} > 85^\circ C$ , please refer to derating curve. The maximum component surface temperature must be lower than  $105^\circ C$  and maximum temperature rise between case and free ambient shall be lower than  $15^\circ C$ .

**Lead spacing 37.5 mm (2 pins, 4 pins)**

500 V DC/250 V AC

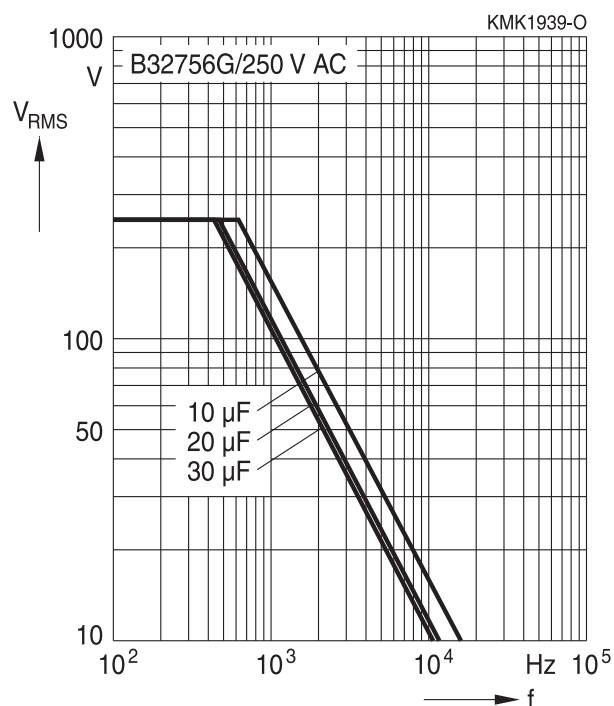

560 V DC/275 V AC

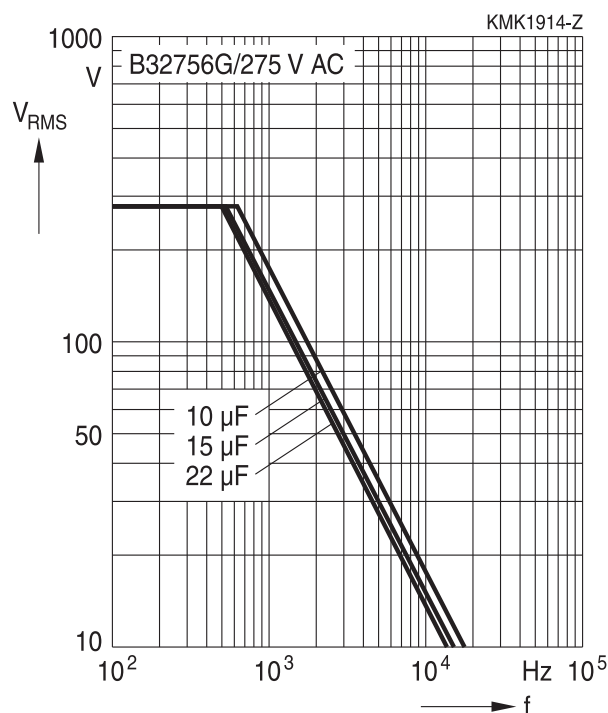

630 V DC/310 V AC

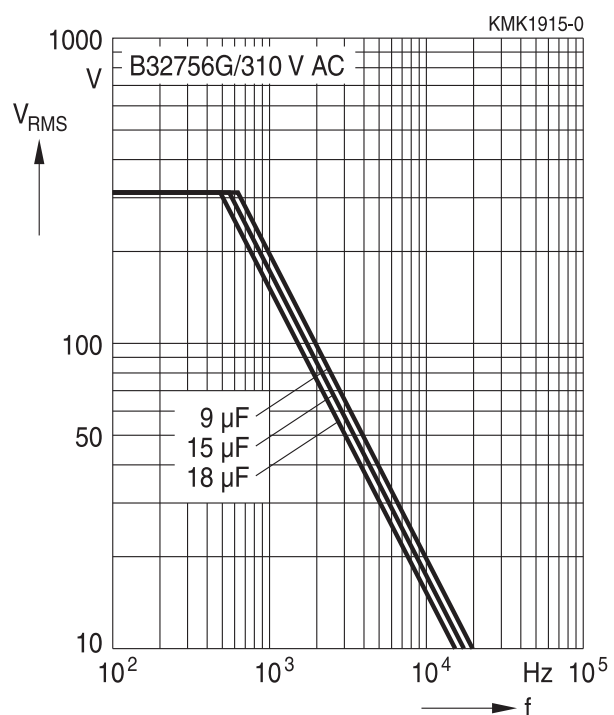

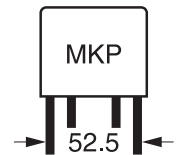

**Permissible AC voltage  $V_{RMS}$  versus frequency  $f$  (for sinusoidal waveforms,  $T_{op} \leq 85^\circ C$ )**

For  $T_{op} > 85^\circ C$ , please refer to derating curve. The maximum component surface temperature must be lower than  $105^\circ C$  and maximum temperature rise between case and free ambient shall be lower than  $15^\circ C$ .

**Lead spacing 52.5 mm**

500 V DC/250 V AC

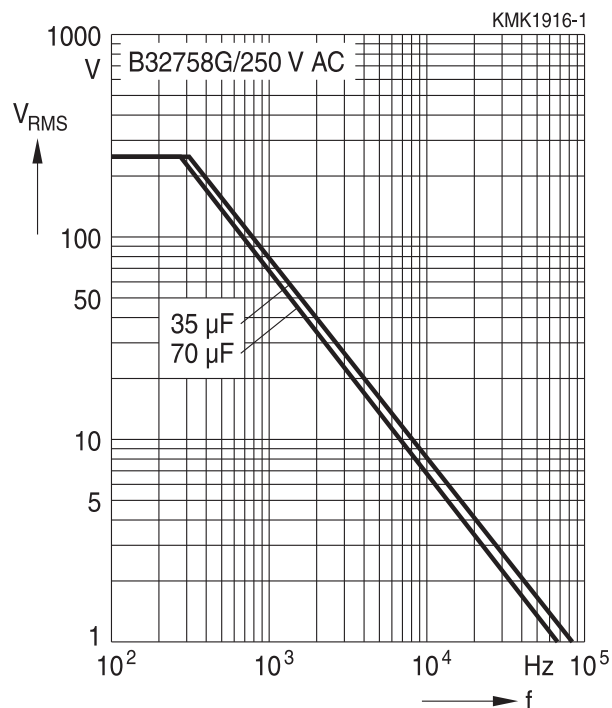

560 V DC/275 V AC

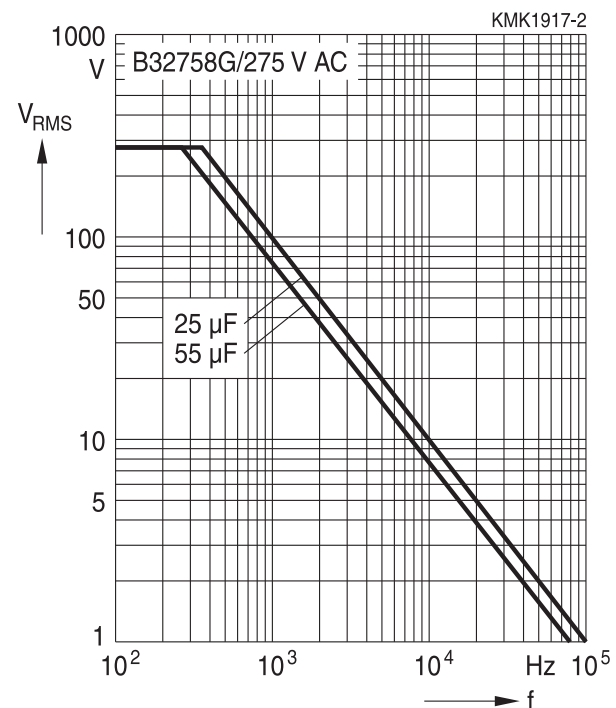

630 V DC/310 V AC

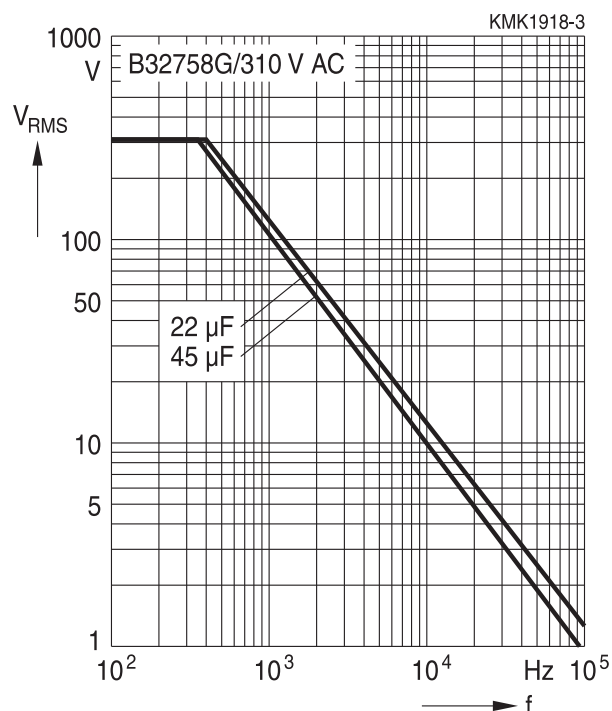



**B32754**

**MKP AC filtering**

**Permissible current  $I_{RMS}$  versus frequency  $f$  (for sinusoidal waveforms  $T_{op} \leq 85^\circ C$ )**

For  $T_{op} > 85^\circ C$ , please use the derating curve. The maximum component surface temperature must be lower than  $105^\circ C$  and maximum temperature rise between case and free ambient shall be lower than  $15^\circ C$ .

**Lead spacing 27.5 mm**

500 V DC/250 V AC

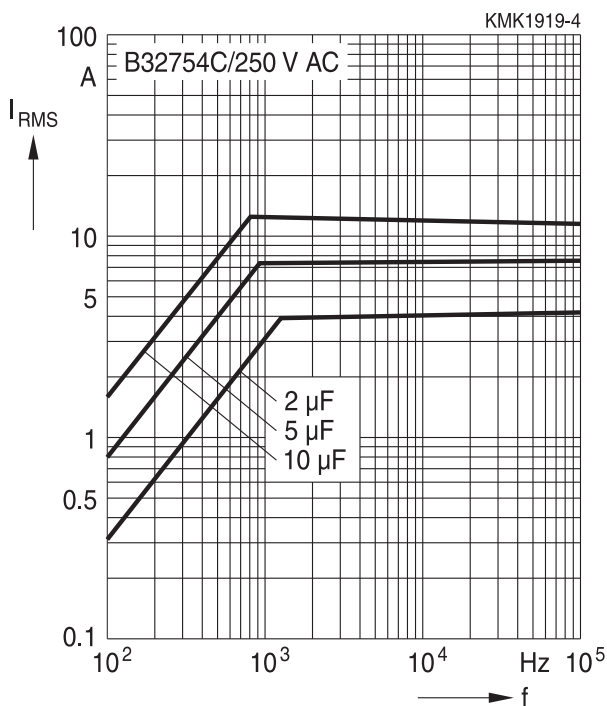

560 V DC/275 V AC

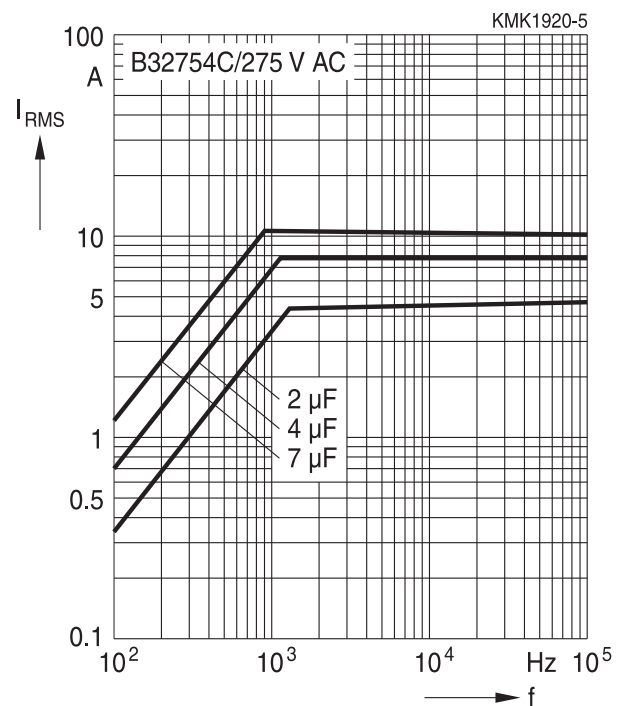

630 V DC/310 V AC

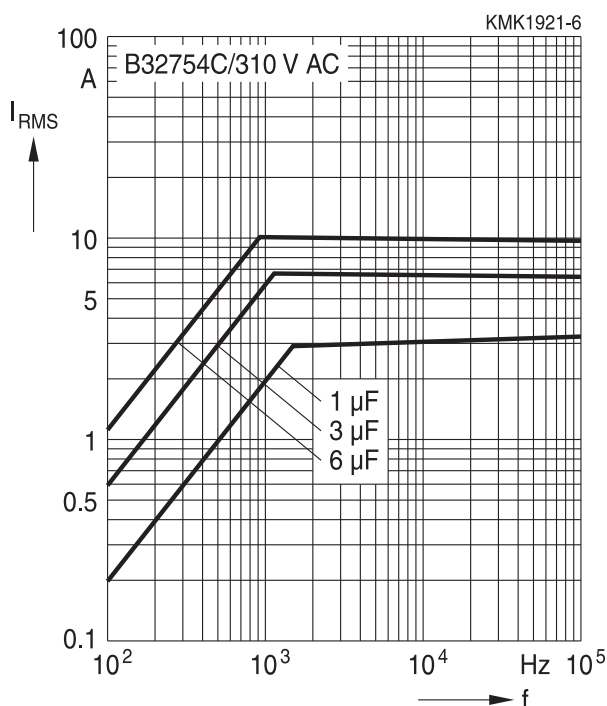



**Permissible current  $I_{RMS}$  versus frequency  $f$  (for sinusoidal waveforms  $T_{op} \leq 85^\circ C$ )**

For  $T_{op} > 85^\circ C$ , please use the derating curve. The maximum component surface temperature must be lower than  $105^\circ C$  and maximum temperature rise between case and free ambient shall be lower than  $15^\circ C$ .

**Lead spacing 37.5 mm (2 pins, 4 pins)**

500 V DC/250 V AC

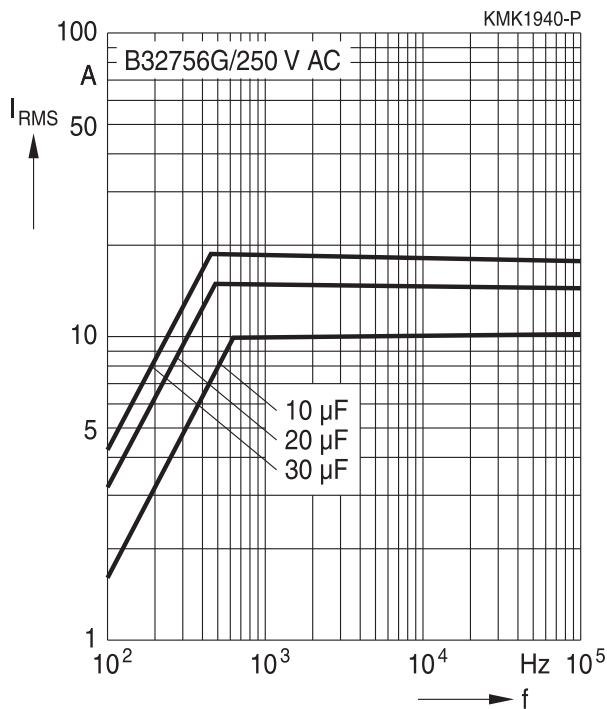

560 V DC/275 V AC

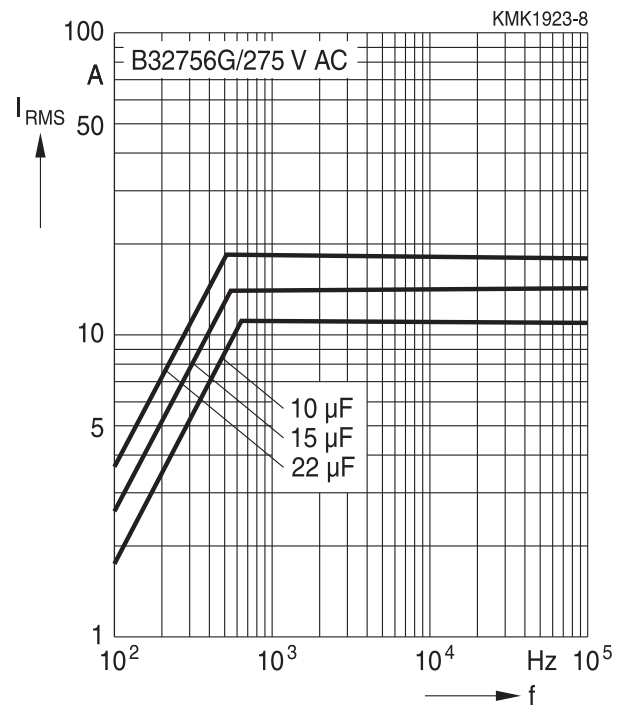

630 V DC/310 V AC

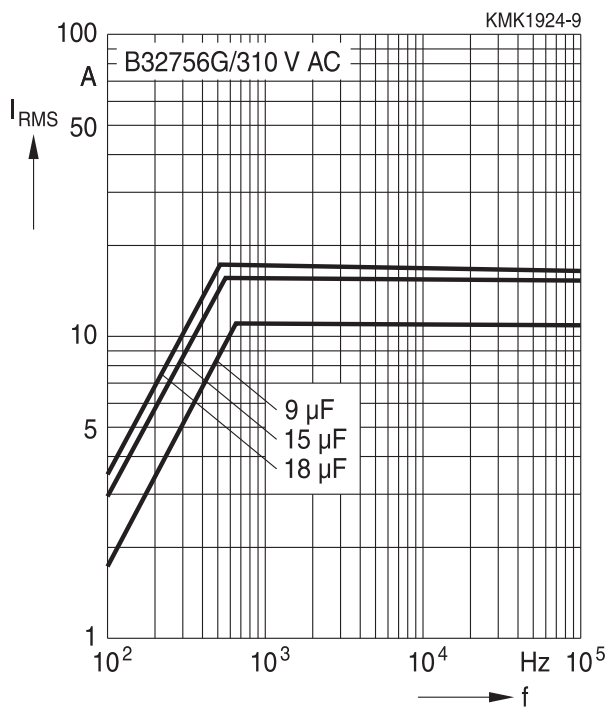

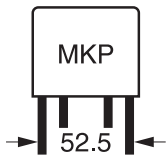

**B32758**

**MKP AC filtering**

**Permissible current  $I_{RMS}$  versus frequency  $f$  (for sinusoidal waveforms  $T_{op} \leq 85^\circ C$ )**

For  $T_{op} > 85^\circ C$ , please use the derating curve. The maximum component surface temperature must be lower than  $105^\circ C$  and maximum temperature rise between case and free ambient shall be lower than  $15^\circ C$ .

**Lead spacing 52.5 mm**

500 V DC/250 V AC

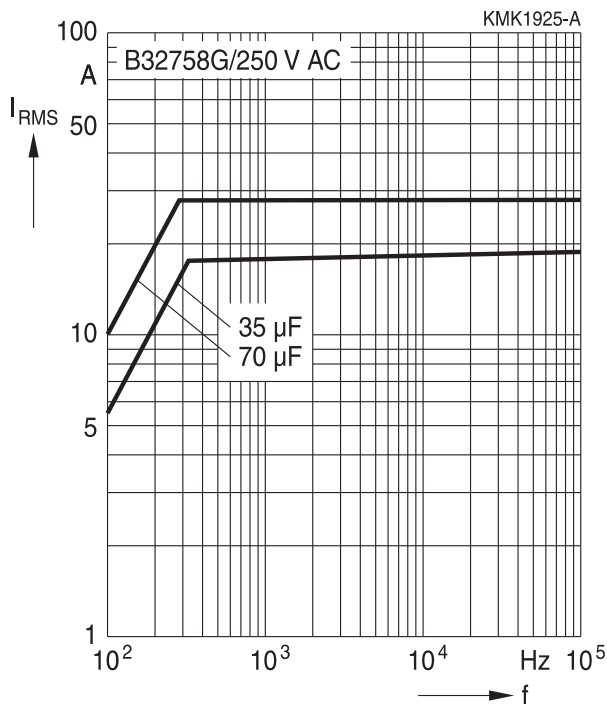

560 V DC/275 V AC

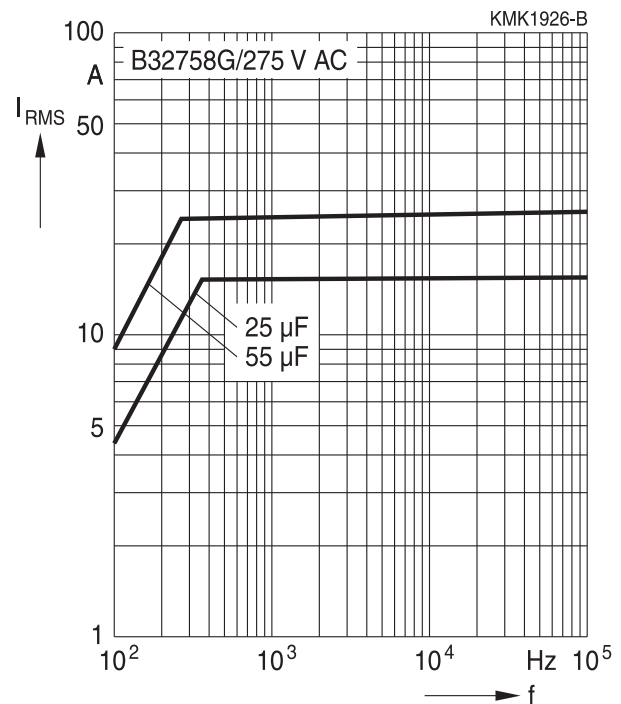

630 V DC/310 V AC

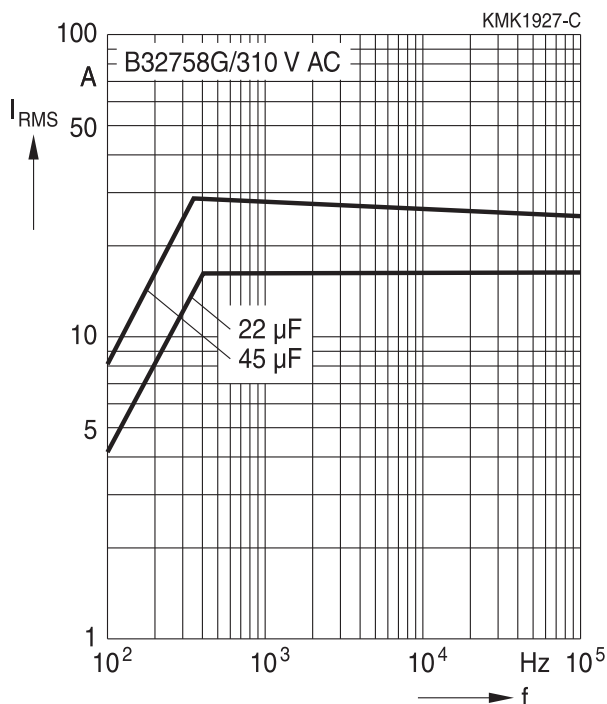



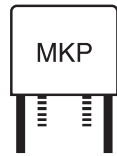

**Maximum permissible continuous DC voltage versus temperature T**

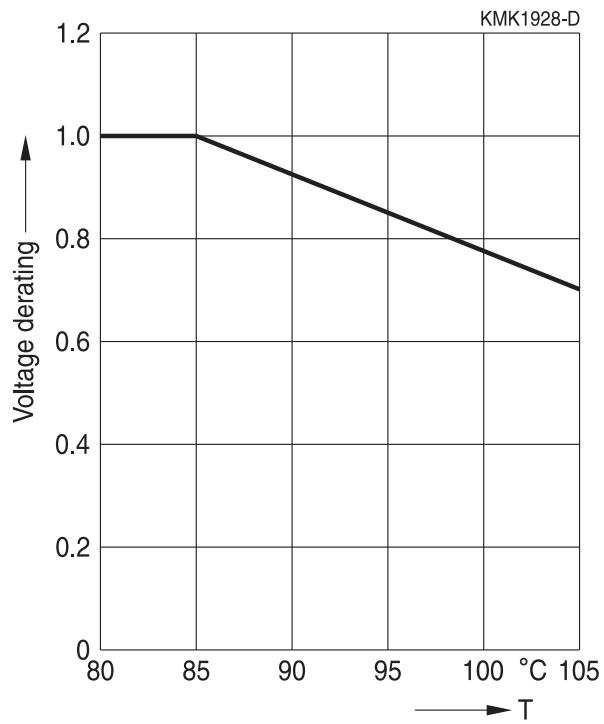



B32754 ... B32758

MKP AC filtering

### Maximum AC voltage ( $V_{RMS}$ ) versus temperature $T_{op} \leq 85\text{ °C}$

The graphs described in the previous section for the maximum AC voltage versus frequency are valid for moderate temperature:  $T_{op} \leq 85\text{ °C}$  in MKP. For temperatures higher than these limits, we have to consider additional effects depending on the frequency and dielectric:

#### Low frequency ( $f < f_1$ )

For frequency below  $f_1$  (the frequency is the  $V_{RMS}$  begin to derating versus frequency), a derating of the  $V_{RMS}$  versus the working temperature has to be applied, following the rules defined above.

#### High frequencies ( $f_1 \leq f$ )

For frequency below  $f_1$  (The frequency is the  $V_{RMS}$  begin to derating versus frequency), a derating of the  $V_{RMS}$  versus the working temperature has to be applied, following the rules defined as below:

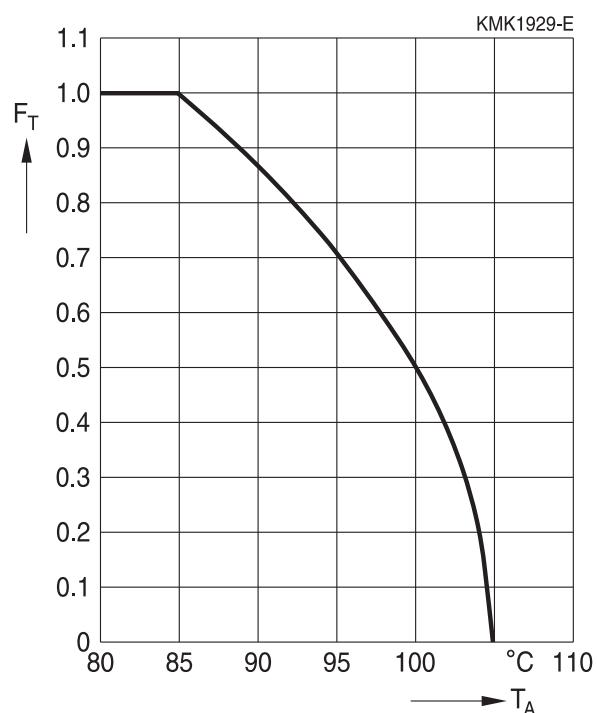

Derating factor  $F_T$  for  $V_{RMS}$  versus  $T_A$



## Testing and Standards

Test	Reference	Conditions of test	Performance requirements
Electrical parameters	IEC 61071:2007	Voltage between terminals: 1.5 V <sub>R</sub> , 60 s Terminals and enclosure: 2000 V AC Insulation resistance R <sub>ins</sub> Capacitance C <sub>R</sub> Dissipation factor tan δ	Within specified limits No visible damage No flashover
Robustness of terminations	IEC 60068-2-21:2006	Tensile strength (test U <sub>a</sub> 1) Wire diameter   Section   Tensile force 0.5 <d <sub>1</sub> ≤ 0.8 mm   ≤0.5m <sup>2</sup>   10 N 0.8 <d <sub>1</sub> ≤ 1.25 mm   ≤1.2m <sup>2</sup>   20 N Duration: 10 s +/- 1s Bending U <sub>b</sub> method 1 Wire diameter   Section   Tensile force 0.5 <d <sub>1</sub> ≤ 0.8 mm   ≤0.5m <sup>2</sup>   10 N 0.8 <d <sub>1</sub> ≤ 1.25 mm   ≤1.2m <sup>2</sup>   20 N 4 × 90 °C Duration: 2 s to 3 s / bend	Within specified specification
Resistance to soldering heat	IEC 60068-2-20:2008	Solder bath temperature at 260 ± 5 °C, immersion for 10 seconds	ΔC/C <sub>0</sub> ≤ 0.5% Increase of tan δ ≤ 0.005
Vibration	IEC 60068-2-6:2007	10 Hz to 55 Hz: Amplitude ±0.35 mm or acceleration 98 m/s <sup>2</sup> Test duration: 10 frequency cycles, 3 axes offset from each other by 90°, 1 octave/min, Visual examination	No visible damage
Bump	IEC 60068-2-6:2007	Pulse shape: half sine Acceleration: 490 m/s <sup>2</sup> Duration of pulse: 11 ms Visual examination	No visible damage  ΔC/C <sub>0</sub>   ≤ 0.5% Increase of tan δ ≤ 0.005 compared to initial value
Damp heat test		60 °C / 95% RH / V <sub>R, AC</sub> / 1000 h	ΔC/C <sub>0</sub>   ≤ 10%  Δ tan δ  ≤ 500% (10 kHz) R <sub>ins</sub> ≥ 50% of minimum as delivered value

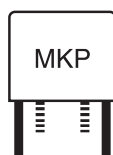

B32754 ... B32758

MKP AC filtering

Test	Reference	Conditions of test	Performance requirements
Surge test	IEC 61071:2007	$1.1 \cdot V_R$ or $I_{\text{test}} = 1.1 I_{\text{max}}$ Number of discharges: 5 Time lapse: every 2 min (10 min total) within 5 min after the surge discharge test Duration: 10 s; $1.5 \cdot V_R$ at $T_A$	No visible damage $ \Delta C/C_0  \leq 1\%$ $\tan \delta$ (10 kHz) $\leq 1.2$ initial $\tan \delta +0.0001$
Self-healing	IEC 61071:2007	$1.5 \cdot V_R$ ; duration 10 s Number of clearings: $\leq 5$ Clearing = voltage drop of 5% Increase the voltage at 100 V/s till 5 clearings occur with a maximum of $2.5 \cdot V_R$ for a duration of 10 s	$ \Delta C/C_0  \leq 0.5\%$ $\tan \delta$ (10 kHz) $\leq 1.12$ initial $\tan \delta +0.0001$
Environmental	IEC 61071:2007	1. Change of temperature acc. to IEC 60068-2-14, test $N_b$ $T_{\text{max.}} = 85 \text{ }^\circ\text{C}$ , $T_{\text{min.}} = -40 \text{ }^\circ\text{C}$ , Transition time: 1 h, equiv. to $1 \text{ }^\circ\text{C}/\text{min}$ , 5 cycles 2. Damp heat steady state acc. to IEC 60068-2-78, test $C_a$ $T = 40 \text{ }^\circ\text{C} \pm 2 \text{ }^\circ\text{C}$ , RH = $93\% \pm 3 \%$ , Duration: 56 days 3. DC voltage between terminal, $1.5 \cdot V_R$ at ambient temperature Duration: 10 s	No puncturing or flashover Self-healing punctures permitted $ \Delta C/C_0  \leq 2\%$ Increase of $\tan \delta$ (10 kHz) $\leq 0.015$
Thermal stability test under overload conditions	IEC 61071:2007	Natural cooling $T_A \pm 5 \text{ }^\circ\text{C}$ $1.21 \cdot P_{\text{max.}} = (V_2/2) \cdot W_2 \cdot C \cdot \tan \delta =$ $1.21 \cdot (I_{\text{max.}}^2/W_2 \cdot C) \cdot \tan \delta_2$ with $W_2 = 2 \cdot \pi \cdot f_2$ for $I_{\text{max.}}$ (see specific reference data) $f_2 = 10 \text{ kHz}$ , duration 48 h Measure the temperature every 1.5 h during the last 6 h	Temperature rise $< 1 \text{ }^\circ\text{C}$ $ \Delta C/C_0  \leq 2\%$ Increase of $\tan \delta$ (10 kHz) $\leq 1.2$ initial $\tan \delta +0.015$
Endurance test between terminal	IEC 61071:2007	Sequence: $1.25 \cdot V_R$ at $T_{\text{max.}} = 85 \text{ }^\circ\text{C}$ $1.0 \cdot V_R$ at $T_{\text{max.}} = 105 \text{ }^\circ\text{C}$ Duration: 500 h $1000 \times$ discharge at $1.4 \cdot I$ (max.repetitive peak current in continuous operation) $1.25 \cdot V_R$ at $T_{\text{max.}} = 85 \text{ }^\circ\text{C}$ $1.0 \cdot V_R$ at $T_{\text{max.}} = 105 \text{ }^\circ\text{C}$ Duration: 500 h	$ \Delta C/C_0  \leq 3\%$ Increase of $\tan \delta \leq 0.015$ compared to initial value

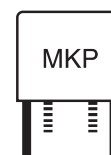

## Mounting guidelines

### 1 Soldering

#### 1.1 Solderability of leads

The solderability of terminal leads is tested to IEC 60068-2-20:2008, test Ta, method 1.

Before a solderability test is carried out, terminals are subjected to accelerated ageing (to IEC 60068-2-2:2007, test Ba: 4 h exposure to dry heat at 155 °C). Since the ageing temperature is far higher than the upper category temperature of the capacitors, the terminal wires should be cut off from the capacitor before the ageing procedure to prevent the solderability being impaired by the products of any capacitor decomposition that might occur.

Solder bath temperature	235 ±5 °C
Soldering time	2.0 ±0.5 s
Immersion depth	2.0 +0/−0.5 mm from capacitor body or seating plane
Evaluation criteria: Visual inspection	Wetting of wire surface by new solder ≥90%, free-flowing solder

#### 1.2 Resistance to soldering heat

Resistance to soldering heat is tested to IEC 60068-2-20:2008, test Tb, method 1.

Conditions:

Series	Solder bath temperature	Soldering time
MKT boxed (except 2.5 × 6.5 × 7.2 mm) coated uncoated (lead spacing >10 mm)	260 ±5 °C	10 ±1 s
MFP MKP (lead spacing >7.5 mm)		
MKT boxed (case 2.5 × 6.5 × 7.2 mm)		5 ±1 s
MKP (lead spacing ≤7.5 mm)		<4 s
MKT uncoated (lead spacing ≤10 mm) insulated (B32559)		recommended soldering profile for MKT uncoated (lead spacing ≤ 10 mm) and insulated (B32559)



**B32754 ... B32758**

**MKP AC filtering**

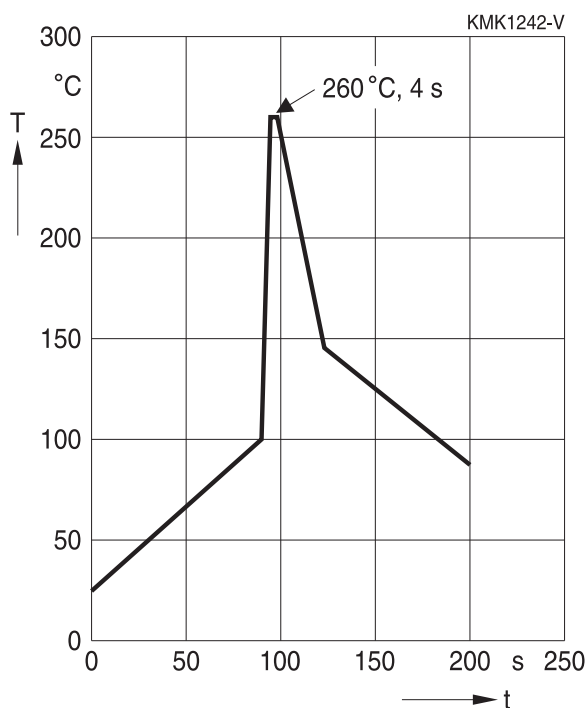

Immersion depth	2.0 +0/−0.5 mm from capacitor body or seating plane
Shield	Heat-absorbing board, (1.5 ±0.5) mm thick, between capacitor body and liquid solder
Evaluation criteria:	
Visual inspection	No visible damage
$\Delta C/C_0$	2% for MKT/MKP/MFP 5% for EMI suppression capacitors
$\tan \delta$	As specified in sectional specification

### 1.3 General notes on soldering

Permissible heat exposure loads on film capacitors are primarily characterized by the upper category temperature  $T_{max}$ . Long exposure to temperatures above this type-related temperature limit can lead to changes in the plastic dielectric and thus change irreversibly a capacitor's electrical characteristics. For short exposures (as in practical soldering processes) the heat load (and thus the possible effects on a capacitor) will also depend on other factors like:

- Pre-heating temperature and time
- Forced cooling immediately after soldering
- Terminal characteristics:  
diameter, length, thermal resistance, special configurations (e.g. crimping)
- Height of capacitor above solder bath
- Shadowing by neighboring components
- Additional heating due to heat dissipation by neighboring components
- Use of solder-resist coatings

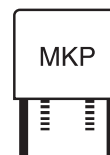

The overheating associated with some of these factors can usually be reduced by suitable countermeasures. For example, if a pre-heating step cannot be avoided, an additional or reinforced cooling process may possibly have to be included.

### EPCOS recommendations

As a reference, the recommended wave soldering profile for our film capacitors is as follows:

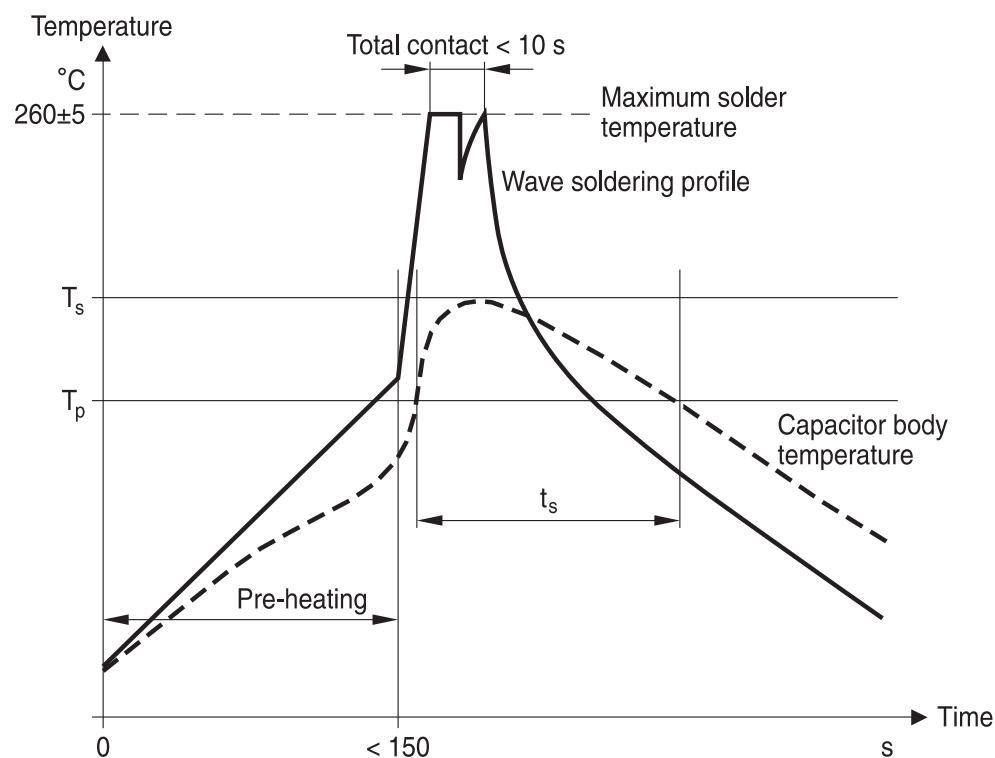

$T_s$ : Capacitor body maximum temperature at wave soldering

$T_p$ : Capacitor body maximum temperature at pre-heating

KMK1745-A-E

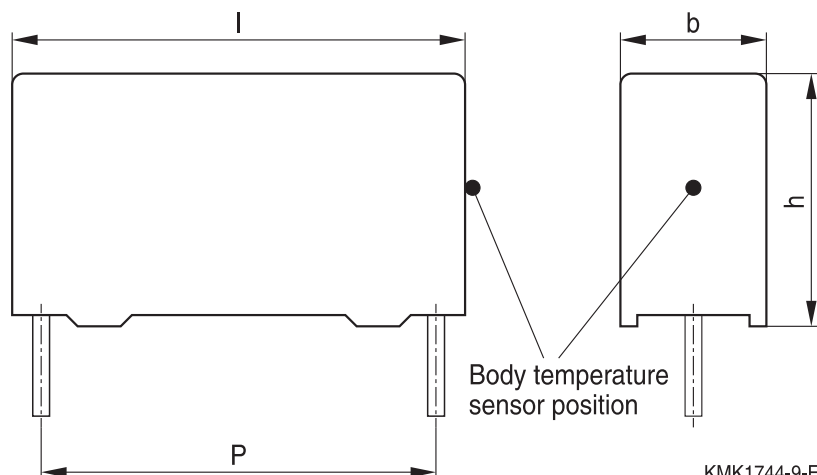

KMK1744-9-E



B32754 ... B32758

**MKP AC filtering**

Body temperature should follow the description below:

- MKP capacitor
  - During pre-heating:  $T_p \leq 110 \text{ }^\circ\text{C}$
  - During soldering:  $T_s \leq 120 \text{ }^\circ\text{C}$ ,  $t_s \leq 45 \text{ s}$
- MKT capacitor
  - During pre-heating:  $T_p \leq 125 \text{ }^\circ\text{C}$
  - During soldering:  $T_s \leq 160 \text{ }^\circ\text{C}$ ,  $t_s \leq 45 \text{ s}$

When SMD components are used together with leaded ones, the film capacitors should not pass into the SMD adhesive curing oven. The leaded components should be assembled after the SMD curing step.

Leaded film capacitors are not suitable for reflow soldering.

In order to ensure proper conditions for manual or selective soldering, the body temperature of the capacitor ( $T_s$ ) must be  $\leq 120 \text{ }^\circ\text{C}$ .

One recommended condition for manual soldering is that the tip of the soldering iron should be  $< 360 \text{ }^\circ\text{C}$  and the soldering contact time should be no longer than 3 seconds.

For uncoated MKT capacitors with lead spacings  $\leq 10 \text{ mm}$  (B32560/B32561) the following measures are recommended:

- pre-heating to not more than  $110 \text{ }^\circ\text{C}$  in the preheater phase
- rapid cooling after soldering

Please refer to EPCOS Film Capacitor Data Book in case more details are needed.



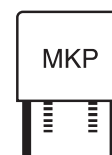

## Cautions and warnings

- Do not exceed the upper category temperature (UCT).
- Do not apply any mechanical stress to the capacitor terminals.
- Avoid any compressive, tensile or flexural stress.
- Do not move the capacitor after it has been soldered to the PC board.
- Do not pick up the PC board by the soldered capacitor.
- Do not place the capacitor on a PC board whose PTH hole spacing differs from the specified lead spacing.
- Do not exceed the specified time or temperature limits during soldering.
- Avoid external energy inputs, such as fire or electricity.
- Avoid overload of the capacitors.
- Consult us if application is with severe temperature and humidity condition.
- There are no serviceable or repairable parts inside the capacitor. Opening the capacitor or any attempts to open or repair the capacitor will void the warranty and liability of EPCOS.
- Please note that the standards referred to in this publication may have been revised in the meantime.

The table below summarizes the safety instructions that must always be observed. A detailed description can be found in the relevant sections of the chapters "General technical information" and "Mounting guidelines".

Topic	Safety information	Reference chapter "General technical information"
Storage conditions	Make sure that capacitors are stored within the specified range of time, temperature and humidity conditions.	4.5 "Storage conditions"
Flammability	Avoid external energy, such as fire or electricity (passive flammability), avoid overload of the capacitors (active flammability) and consider the flammability of materials.	5.3 "Flammability"
Resistance to vibration	Do not exceed the tested ability to withstand vibration. The capacitors are tested to IEC 60068-2-6:2007. EPCOS offers film capacitors specially designed for operation under more severe vibration regimes such as those found in automotive applications. Consult our catalog "Film Capacitors for Automotive Electronics".	5.2 "Resistance to vibration"

Topic	Safety information	Reference chapter "Mounting guidelines"
Soldering	Do not exceed the specified time or temperature limits during soldering.	1 "Soldering"
Cleaning	Use only suitable solvents for cleaning capacitors.	2 "Cleaning"



B32754 ... B32758

**MKP AC filtering**

Topic	Safety information	Reference chapter "Mounting guidelines"
Embedding of capacitors in finished assemblies	When embedding finished circuit assemblies in plastic resins, chemical and thermal influences must be taken into account. Caution: Consult us first, if you also wish to embed other uncoated component types!	3 "Embedding of capacitors in finished assemblies"

### Display of ordering codes for EPCOS products

The ordering code for one and the same product can be represented differently in data sheets, data books, other publications and the website of EPCOS, or in order-related documents such as shipping notes, order confirmations and product labels. **The varying representations of the ordering codes are due to different processes employed and do not affect the specifications of the respective products.** Detailed information can be found on the Internet under [www.epcos.com/orderingcodes](http://www.epcos.com/orderingcodes).



## Symbols and terms

Symbol	English	German
$\alpha$	Heat transfer coefficient	Wärmeübergangszahl
$\alpha_C$	Temperature coefficient of capacitance	Temperaturkoeffizient der Kapazität
A	Capacitor surface area	Kondensatoroberfläche
$\beta_C$	Humidity coefficient of capacitance	Feuchtekoeffizient der Kapazität
C	Capacitance	Kapazität
$C_R$	Rated capacitance	Nennkapazität
$\Delta C$	Absolute capacitance change	Absolute Kapazitätsänderung
$\Delta C/C$	Relative capacitance change (relative deviation of actual value)	Relative Kapazitätsänderung (relative Abweichung vom Ist-Wert)
$\Delta C/C_R$	Capacitance tolerance (relative deviation from rated capacitance)	Kapazitätstoleranz (relative Abweichung vom Nennwert)
dt	Time differential	Differentielle Zeit
$\Delta t$	Time interval	Zeitintervall
$\Delta T$	Absolute temperature change (self-heating)	Absolute Temperaturänderung (Selbsterwärmung)
$\Delta \tan \delta$	Absolute change of dissipation factor	Absolute Änderung des Verlustfaktors
$\Delta V$	Absolute voltage change	Absolute Spannungsänderung
dV/dt	Time differential of voltage function (rate of voltage rise)	Differentielle Spannungsänderung (Spannungsflankensteilheit)
$\Delta V/\Delta t$	Voltage change per time interval	Spannungsänderung pro Zeitintervall
E	Activation energy for diffusion	Aktivierungsenergie zur Diffusion
ESL	Self-inductance	Eigeninduktivität
ESR	Equivalent series resistance	Ersatz-Serienwiderstand
f	Frequency	Frequenz
$f_1$	Frequency limit for reducing permissible AC voltage due to thermal limits	Grenzfrequenz für thermisch bedingte Reduzierung der zulässigen Wechselspannung
$f_2$	Frequency limit for reducing permissible AC voltage due to current limit	Grenzfrequenz für strombedingte Reduzierung der zulässigen Wechselspannung
$f_r$	Resonant frequency	Resonanzfrequenz
$F_D$	Thermal acceleration factor for diffusion	Therm. Beschleunigungsfaktor zur Diffusion
$F_T$	Derating factor	Deratingfaktor
i	Current (peak)	Stromspitze
$I_C$	Category current (max. continuous current)	Kategoriestrom (max. Dauerstrom)

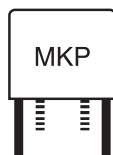

B32754 ... B32758

MKP AC filtering

Symbol	English	German
$I_{RMS}$	(Sinusoidal) alternating current, root-mean-square value	(Sinusförmiger) Wechselstrom
$i_z$	Capacitance drift	Inkonstanz der Kapazität
$k_0$	Pulse characteristic	Impuls Kennwert
$L_S$	Series inductance	Serieninduktivität
$\lambda$	Failure rate	Ausfallrate
$\lambda_0$	Constant failure rate during useful service life	Konstante Ausfallrate in der Nutzungsphase
$\lambda_{test}$	Failure rate, determined by tests	Experimentell ermittelte Ausfallrate
$P_{diss}$	Dissipated power	Abgegebene Verlustleistung
$P_{gen}$	Generated power	Erzeugte Verlustleistung
$Q$	Heat energy	Wärmeenergie
$\rho$	Density of water vapor in air	Dichte von Wasserdampf in Luft
$R$	Universal molar constant for gases	Allg. Molarkonstante für Gas
$R$	Ohmic resistance of discharge circuit	Ohmscher Widerstand des Entladekreises
$R_i$	Internal resistance	Innenwiderstand
$R_{ins}$	Insulation resistance	Isolationswiderstand
$R_P$	Parallel resistance	Parallelwiderstand
$R_S$	Series resistance	Serienwiderstand
$S$	severity (humidity test)	Schärfegrad (Feuchtetest)
$t$	Time	Zeit
$T$	Temperature	Temperatur
$\tau$	Time constant	Zeitkonstante
$\tan \delta$	Dissipation factor	Verlustfaktor
$\tan \delta_D$	Dielectric component of dissipation factor	Dielektrischer Anteil des Verlustfaktors
$\tan \delta_P$	Parallel component of dissipation factor	Parallelanteil des Verlustfaktors
$\tan \delta_S$	Series component of dissipation factor	Serienanteil des Verlustfaktors
$T_A$	Temperature of the air surrounding the component	Temperatur der Luft, die das Bauteil umgibt
$T_{max}$	Upper category temperature	Obere Kategorietemperatur
$T_{min}$	Lower category temperature	Untere Kategorietemperatur
$t_{OL}$	Operating life at operating temperature and voltage	Betriebszeit bei Betriebstemperatur und -spannung
$T_{op}$	Operating temperature, $T_A + \Delta T$	Betriebstemperatur, $T_A + \Delta T$
$T_R$	Rated temperature	Nenntemperatur
$T_{ref}$	Reference temperature	Referenztemperatur
$t_{SL}$	Reference service life	Referenz-Lebensdauer



Symbol	English	German
$V_{AC}$	AC voltage	Wechselspannung
$V_C$	Category voltage	Kategorie <span>spannung</span>
$V_{C,RMS}$	Category AC voltage	(Sinusförmige) Kategorie-Wechselspannung
$V_{CD}$	Corona-discharge onset voltage	Teilentlade-Einsatzspannung
$V_{ch}$	Charging voltage	Ladespannung
$V_{DC}$	DC voltage	Gleichspannung
$V_{FB}$	Fly-back capacitor voltage	Spannung (Flyback)
$V_i$	Input voltage	Eingangsspannung
$V_o$	Output voltage	Ausgangsspannung
$V_{op}$	Operating voltage	Betriebsspannung
$V_p$	Peak pulse voltage	Impuls-Spitzen <span>spannung</span>
$V_{pp}$	Peak-to-peak voltage Impedance	Spannungshub
$V_R$	Rated voltage	Nennspannung
$\hat{V}_R$	Amplitude of rated AC voltage	Amplitude der Nenn-Wechselspannung
$V_{RMS}$	(Sinusoidal) alternating voltage, root-mean-square value	(Sinusförmige) Wechselspannung
$V_{SC}$	S-correction voltage	Spannung bei Anwendung "S-correction"
$V_{sn}$	Snubber capacitor voltage	Spannung bei Anwendung "Beschaltung"
$Z$	Impedance	Scheinwiderstand
$e$	Lead spacing	Rastermaß

## Important notes

The following applies to all products named in this publication:

1. Some parts of this publication contain **statements about the suitability of our products for certain areas of application**. These statements are based on our knowledge of typical requirements that are often placed on our products in the areas of application concerned. We nevertheless expressly point out **that such statements cannot be regarded as binding statements about the suitability of our products for a particular customer application**. As a rule, EPCOS is either unfamiliar with individual customer applications or less familiar with them than the customers themselves. For these reasons, it is always ultimately incumbent on the customer to check and decide whether an EPCOS product with the properties described in the product specification is suitable for use in a particular customer application.
2. We also point out that **in individual cases, a malfunction of electronic components or failure before the end of their usual service life cannot be completely ruled out in the current state of the art, even if they are operated as specified**. In customer applications requiring a very high level of operational safety and especially in customer applications in which the malfunction or failure of an electronic component could endanger human life or health (e.g. in accident prevention or lifesaving systems), it must therefore be ensured by means of suitable design of the customer application or other action taken by the customer (e.g. installation of protective circuitry or redundancy) that no injury or damage is sustained by third parties in the event of malfunction or failure of an electronic component.
3. **The warnings, cautions and product-specific notes must be observed.**
4. In order to satisfy certain technical requirements, **some of the products described in this publication may contain substances subject to restrictions in certain jurisdictions (e.g. because they are classed as hazardous)**. Useful information on this will be found in our Material Data Sheets on the Internet ([www.epcos.com/material](http://www.epcos.com/material)). Should you have any more detailed questions, please contact our sales offices.
5. We constantly strive to improve our products. Consequently, **the products described in this publication may change from time to time**. The same is true of the corresponding product specifications. Please check therefore to what extent product descriptions and specifications contained in this publication are still applicable before or when you place an order. We also **reserve the right to discontinue production and delivery of products**. Consequently, we cannot guarantee that all products named in this publication will always be available. The aforementioned does not apply in the case of individual agreements deviating from the foregoing for customer-specific products.
6. Unless otherwise agreed in individual contracts, **all orders are subject to the current version of the "General Terms of Delivery for Products and Services in the Electrical Industry" published by the German Electrical and Electronics Industry Association (ZVEI)**.

## Important notes

7. **Our manufacturing sites serving the automotive business apply the IATF 16949 standard.** The IATF certifications confirm our compliance with requirements regarding the quality management system in the automotive industry. Referring to customer requirements and customer specific requirements (“CSR”) TDK always has and will continue to have the policy of respecting individual agreements. Even if IATF 16949 may appear to support the acceptance of unilateral requirements, we hereby like to emphasize that **only requirements mutually agreed upon can and will be implemented in our Quality Management System.** For clarification purposes we like to point out that obligations from IATF 16949 shall only become legally binding if individually agreed upon.
8. The trade names EPCOS, CeraCharge, CeraDiode, CeraLink, CeraPad, CeraPlas, CSMP, CTVS, DeltaCap, DigiSiMic, ExoCore, FilterCap, FormFit, LeaXield, MiniBlue, MiniCell, MKD, MKK, MotorCap, PCC, PhaseCap, PhaseCube, PhaseMod, PhiCap, PowerHap, PQSine, PQvar, SIFERRIT, SIFI, SIKOREL, SilverCap, SIMDAD, SiMic, SIMID, SineFormer, SIOV, ThermoFuse, WindCap are **trademarks registered or pending** in Europe and in other countries. Further information will be found on the Internet at [www.epcos.com/trademarks](http://www.epcos.com/trademarks).

Release 2018-06

## X-ON Electronics

Largest Supplier of Electrical and Electronic Components

*Click to view similar products for [tdk manufacturer](#):*

Other Similar products are found below :

[VLF5012ST-1R0N2R5](#) [R14493](#) [SWS1000L-24/BL](#) [C3225X5R0J686M200AC](#) [VLF5014AT-150MR76](#) [VLF5014AT-6R8MR99](#) [CXA-2115](#)  
[MCZ1210AH301L2T](#) [78P7200-IH/F](#) [MLP2012S1R5TT](#) [ACH3218-682-TD01](#) [ACT45B-KIT](#) [NL565050T-822J-PF](#) [C1005JB1H471K050BA](#)  
[C1608CH1H151J080AA](#) [C2012JB1H105K125AB](#) [C4532NP01H154J250KA](#) [CD75-B2GA331KYGKA](#) [CLF10040T-221M](#) [CLF12555T-](#)  
[220M](#) [MLF1005LR12K](#) [MLP2520S1R0ST](#) [MLP2520S1R5MT](#) [VLS252015T-3R3M1R0](#) [VLS4012T-150MR65](#) [ZCAT-KIT](#) [MPZ2012-KIT](#)  
[NLV32T-R27J-EFD](#) [CKCM25C0G2A101K060AK](#) [CLF10040T-4R7N](#) [WTM505090-10K2-5V-G1](#) [VLS252010HBX-R24M-1](#)  
[CGJ2B2X7R1C222K](#) [CGA9M1X7T2J334K](#) [CGA8P3X7T2E105M/SOFT](#) [CGA6J4C0G2J392J](#) [CGA6M3X7R2E154K](#) [CGA3E3C0G2E181J](#)  
[CGA2B2C0G1H331J](#) [C-WPTX01-E6-KIT](#) [CEU-AC01-E6-KIT](#) [CERB3UX5R0G105M](#) [RLF12545T-100M5R1-PF](#) [CCT406393-600-36-02](#)  
[PFC3819QM-181K09B-00](#) [VLF3010AT-100MR49](#) [MMZ0603D330C](#) [MPZ2012S102ATD25](#) [MLG1608B18NJ](#) [UHV-251A](#)