



SOT-23 Plastic-Encapsulate Transistors

2SA1162 TRANSISTOR (PNP)

FEATURES

- Low noise
- Complementary to 2SC2712
- Small Package

MARKING: SO , SY , SG

MAXIMUM RATINGS (T_a=25°C unless otherwise noted)

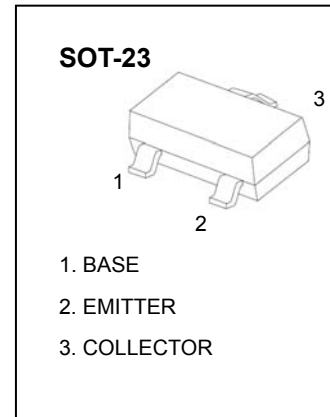

Symbol	Parameter	Value	Unit
V _{CB0}	Collector-Base Voltage	-50	V
V _{CEO}	Collector-Emitter Voltage	-50	V
V _{EBO}	Emitter-Base Voltage	-5	V
I _C	Current -Continuous	-150	mA
P _D	Collector Power Dissipation	150	mW
T _J	Junction Temperature	150	°C
T _{stg}	Storage Temperature	-55~+150	°C

ELECTRICAL CHARACTERISTICS (T_a=25°C unless otherwise specified)

Parameter	Symbol	Test conditions	Min	Typ	Max	Unit
Collector-base breakdown voltage	V _{(BR)CBO}	I _C =-100μA, I _E =0	-50			V
Collector-emitter breakdown voltage	V _{(BR)CEO}	I _C =-1mA, I _B =0	-50			V
Emitter-base breakdown voltage	V _{(BR)EBO}	I _E =-100μA, I _C =0	-5			V
Collector cut-off current	I _{CBO}	V _{CB} =-50V, I _E =0			-0.1	μA
Emitter cut-off current	I _{EBO}	V _{EB} =-5V, I _C =0			-0.1	μA
DC current gain	h _{FE}	V _{CE} =-6V, I _C =-2mA	70		400	
Collector-emitter saturation voltage	V _{CE(sat)}	I _C =-100mA, I _B =-10mA			-0.3	V
Transition frequency	f _T	V _{CE} =-10V, I _C =-1mA	80			MHz
Collector output capacitance	C _{ob}	V _{CB} =-10V, I _E =0, f=1MHz			7	pF
Noise figure	NF	V _{CE} =-6V, I _C =0.1mA, f=1KHz, R _g =10KΩ			10	dB

CLASSIFICATION OF h_{FE}

Rank	O	Y	GR(G)
Range	70-140	120-240	200-400

Typical Characteristics

2SA1162

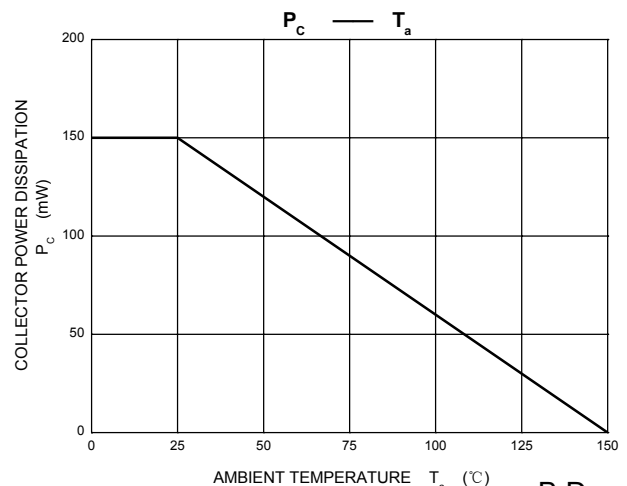
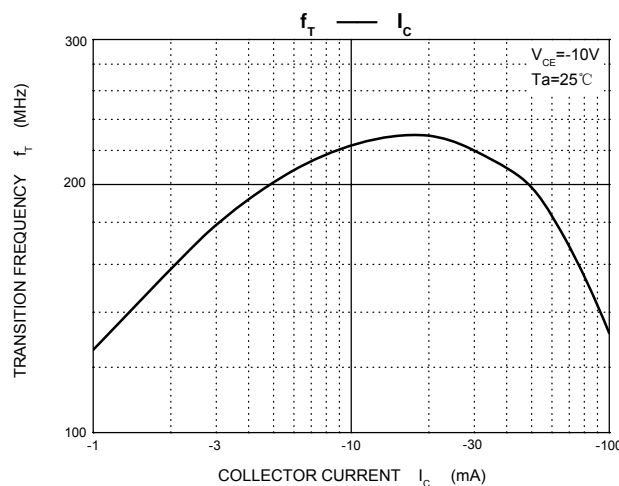
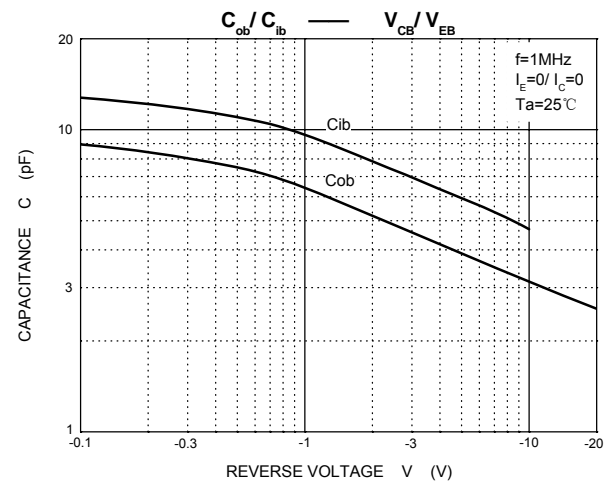
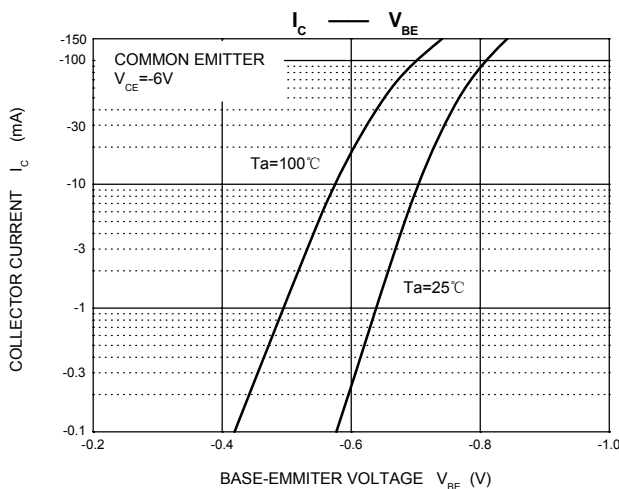
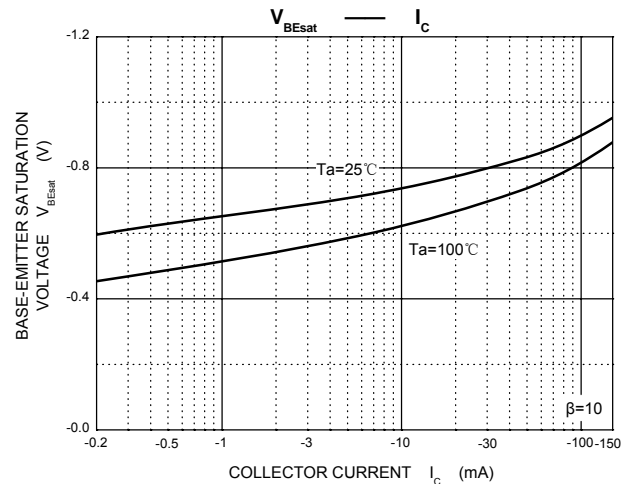
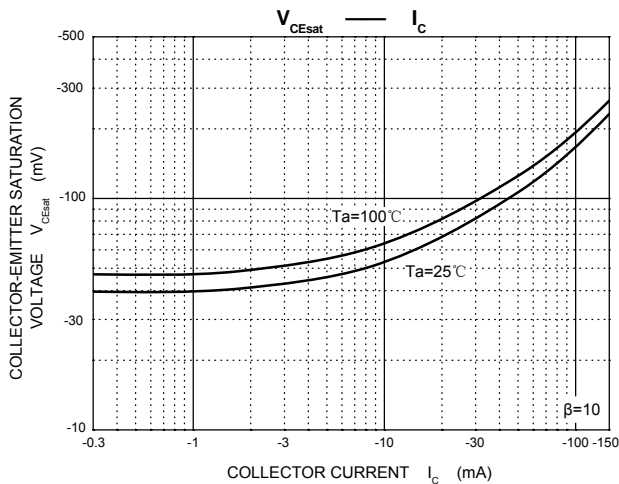
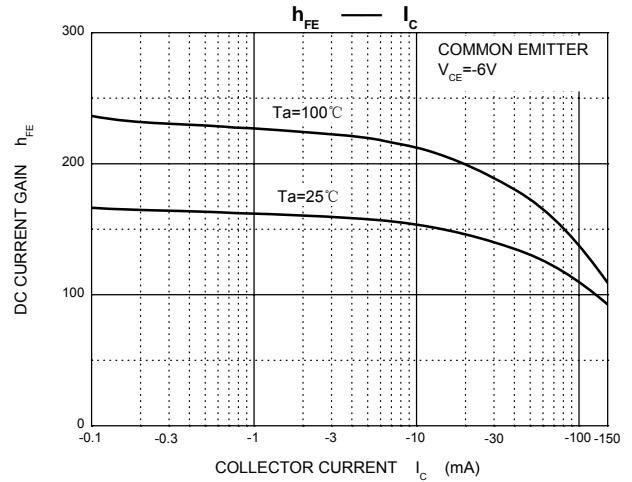
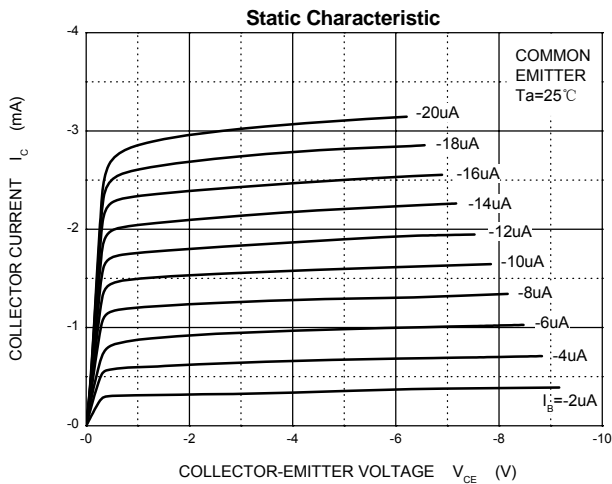

X-ON Electronics

Largest Supplier of Electrical and Electronic Components

Click to view similar products for [Bipolar Transistors - BJT category](#):

Click to view products by [Changjiang manufacturer](#):

Other Similar products are found below :

[619691C](#) [MCH4017-TL-H](#) [MJ15024/WS](#) [MJ15025/WS](#) [BC546/116](#) [BC556/FSC](#) [BC557/116](#) [BSW67A](#) [HN7G01FU-A\(T5L,F,T](#)
[NJVMJD148T4G](#) [NSVMMBT6520LT1G](#) [NTE187A](#) [NTE195A](#) [NTE2302](#) [NTE2330](#) [NTE2353](#) [NTE316](#) [IMX9T110](#) [NTE63](#) [NTE65](#)
[C4460](#) [SBC846BLT3G](#) [2SA1419T-TD-H](#) [2SA1721-O\(TE85L,F\)](#) [2SA1727TLP](#) [2SA2126-E](#) [2SB1202T-TL-E](#) [2SB1204S-TL-E](#) [2SC5488A-](#)
[TL-H](#) [2SD2150T100R](#) [SP000011176](#) [FMC5AT148](#) [2N2369ADCSM](#) [2SB1202S-TL-E](#) [2SC2412KT146S](#) [2SC4618TLN](#) [2SC5490A-TL-H](#)
[2SD1816S-TL-E](#) [2SD1816T-TL-E](#) [CMXT2207 TR](#) [CPH6501-TL-E](#) [MCH4021-TL-E](#) [BC557B](#) [TTC012\(Q\)](#) [BULD128DT4](#) [JANTX2N3810](#)
[Jantx2N5416](#) [US6T6TR](#) [KSF350](#) [068071B](#)