

## SOD-523 Plastic-Encapsulate Diodes

### CESD3V3D5 Uni-direction ESD Protection Diode

#### DESCRIPTION

Designed to protect voltage sensitive electronic components from ESD and other transients. Excellent clamping capability, low leakage, and fast response time provide best in class protection on designs that are exposed to ESD.

The combination of small size, high level of ESD protection makes them a flexible solution for applications such as HDMI, Display Port TM, and MDDI interfaces. It is designed to replace multilayer varistors (MLV) in consumer equipments applications such as mobile phone, notebook, PAD, STB, LCD TV etc.

#### SOD-523

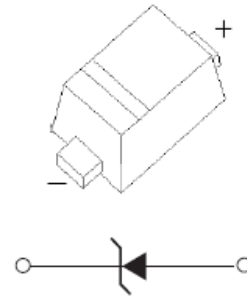

#### FEATURES

- Uni-directional ESD protection of one line
- Reverse stand-off voltage: 3.3V
- Low reverse clamping voltage
- Low leakage current
- Excellent package: 1.2mm × 0.8mm × 0.6mm
- Fast response time
- JESD22-A114-B ESD Rating of class 3B per human body model
- IEC 61000-4-2 Level 4 ESD protection

#### APPLICATIONS

- Computers and peripherals
- Audio and video equipment
- Cellular handsets and accessories
- Portable electronics
- Other electronics equipments communication systems

#### MARKING

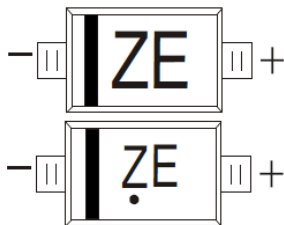

Front side

ZE = Device code

The marking bar indicates the cathode

Solid dot = Green molding compound device, if none, the normal device

**MAXIMUM RATINGS (  $T_a=25^{\circ}\text{C}$  unless otherwise noted )**

| Parameter  | Symbol                 | Limit      | Unit               |
|--|------------------------|------------|--------------------|
| IEC 61000-4-2 ESD Voltage                              | Air Model              | $\pm 25$   | kV                 |
|  | Contact Model          | $\pm 25$   |                    |
|  | Per Human Body Model   | $\pm 16$   |                    |
|  | Machine Model          | $\pm 0.4$  |                    |
| JESD22-A114-B ESD Voltage                              | $V_{\text{ESD}}^{(1)}$ |            |                    |
| ESD Voltage  |                        |            |                    |
| Peak Pulse Power                                       | $P_{\text{PP}}^{(2)}$  | 210        | W                  |
| Peak Pulse Current                                     | $I_{\text{PP}}^{(2)}$  | 16         | A                  |
| Lead Solder Temperature – Maximum (10 Second Duration) | $T_L$                  | 260        | $^{\circ}\text{C}$ |
| Junction Temperature                                   | $T_j$                  | 150        | $^{\circ}\text{C}$ |
| Storage Temperature Range                              | $T_{\text{stg}}$       | -55 ~ +150 | $^{\circ}\text{C}$ |

(1).Device stressed with ten non-repetitive ESD pulses.

(2).Non-repetitive current pulse 8/20 $\mu\text{s}$  exponential decay waveform according to IEC61000-4-5.

**ESD standards compliance**

**IEC61000-4-2 Standard**

| Contact Discharge |                 | Air Discharge |                 |
|-------------------|-----------------|---------------|-----------------|
| Level             | Test Voltage kV | Level         | Test Voltage kV |
| 1                 | 2               | 1             | 2               |
| 2                 | 4               | 2             | 4               |
| 3                 | 6               | 3             | 8               |
| 4                 | 8               | 4             | 15              |

**JESD22-A114-B Standard**

| ESD Class | Human Body Discharge V |
|-----------|------------------------|
| 0         | 0~249                  |
| 1A        | 250~499                |
| 1B        | 500~999                |
| 1C        | 1000~1999              |
| 2         | 2000~3999              |
| 3A        | 4000~7999              |
| 3B        | 8000~15999             |

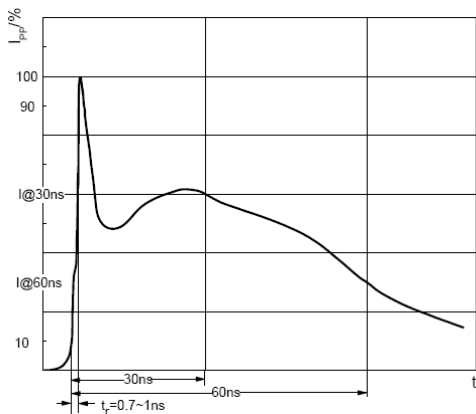

ESD pulse waveform according to IEC61000-4-2



8/20 $\mu\text{s}$  pulse waveform according to IEC 61000-4-5

**ELECTRICAL PARAMETER**

| Symbol    | Parameter                           |
|-----------|-------------------------------------|
| $V_C$     | Clamping Voltage @ $I_{PP}$         |
| $I_{PP}$  | Peak Pulse Current                  |
| $V_{BR}$  | Breakdown Voltage @ $I_T$           |
| $I_T$     | Test Current                        |
| $I_R$     | Reverse Leakage Current @ $V_{RWM}$ |
| $V_{RWM}$ | Reverse Standoff Voltage            |
| $V_F$     | Forward Voltage@ $I_F$              |
| $I_F$     | Forward Current                     |

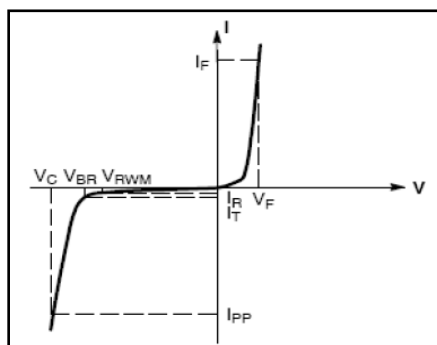

V-I characteristics for a uni-directional TVS

**ELECTRICAL CHARACTERISTICS( $T_a=25^{\circ}C$  unless otherwise specified)**

| Parameter                 | Symbol          | Test conditions  | Min | Typ | Max  | Unit    |
|---------------------------|-----------------|------------------|-----|-----|------|---------|
| Reverse stand off voltage | $V_{RWM}^{(1)}$ |                  |     |     | 3.3  | V       |
| Reverse leakage current   | $I_R$           | $V_{RWM}=3.3V$   |     |     | 0.08 | $\mu A$ |
| Breakdown voltage         | $V_{(BR)}$      | $I_T=1mA$        | 5.0 |     | 5.9  | V       |
| Clamping voltage          | $V_C^{(2)}$     | $I_{PP}=16A$     |     |     | 13   | V       |
| Forward voltage           | $V_F$           | $I_F=10mA$       |     |     | 0.9  | V       |
| Junction capacitance      | $C_J$           | $V_R=0V, f=1MHz$ |     | 120 |      | pF      |

(1).Other voltages available upon request.

(2).Non-repetitive current pulse 8/20 $\mu s$  exponential decay waveform according to IEC61000-4-5

TYPICAL CHARACTERISTICS

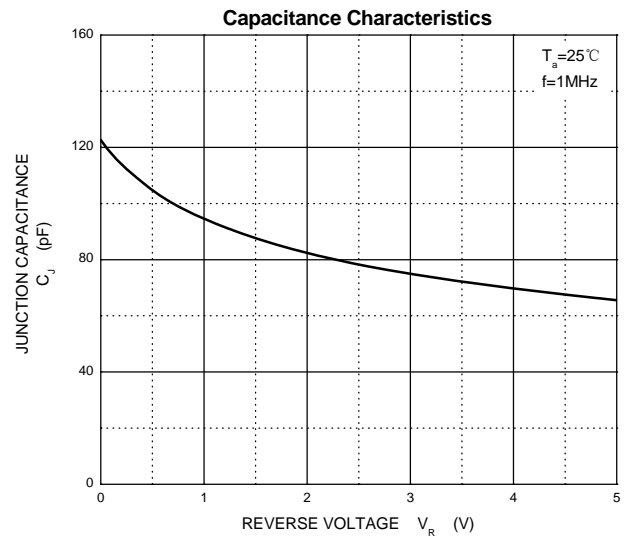
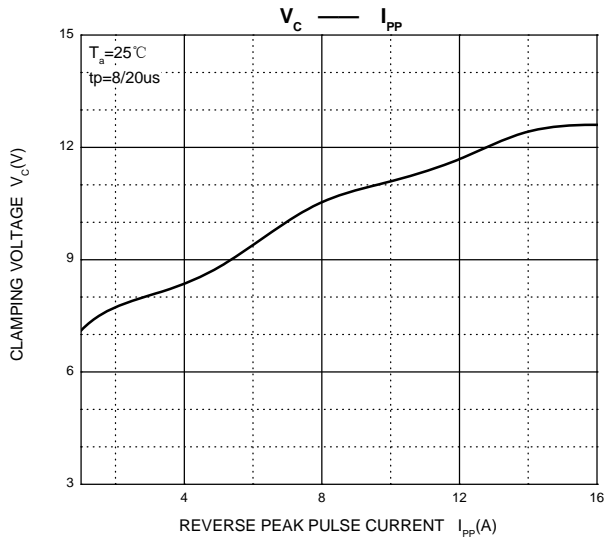
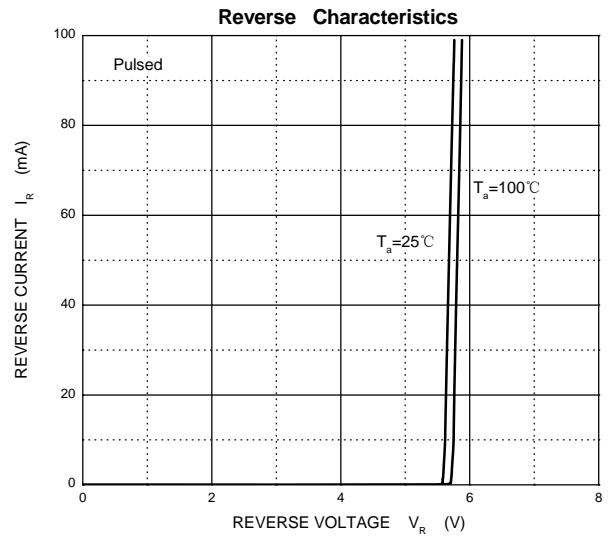
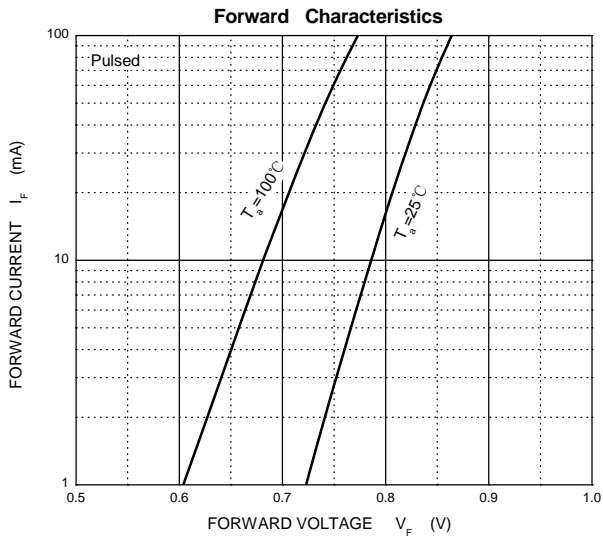

**PACKAGE OUTLINE AND PAD LAYOUT INFORMATION**

**SOD-523 Package Outline Dimensions**

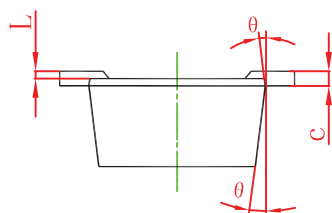
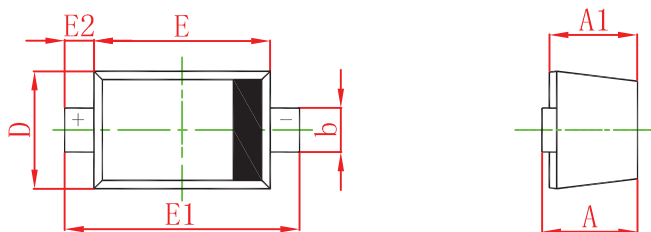

| Symbol | Dimensions In Millimeters |       | Dimensions In Inches |       |
|--------|---------------------------|-------|----------------------|-------|
|        | Min                       | Max   | Min                  | Max   |
| A      | 0.510                     | 0.770 | 0.020                | 0.031 |
| A1     | 0.500                     | 0.700 | 0.020                | 0.028 |
| b      | 0.250                     | 0.350 | 0.010                | 0.014 |
| c      | 0.080                     | 0.150 | 0.003                | 0.006 |
| D      | 0.750                     | 0.850 | 0.030                | 0.033 |
| E      | 1.100                     | 1.300 | 0.043                | 0.051 |
| E1     | 1.500                     | 1.700 | 0.059                | 0.067 |
| E2     | 0.200 REF                 |       | 0.008 REF            |       |
| L      | 0.010                     | 0.070 | 0.001                | 0.003 |
| θ      | 7° REF                    |       | 7° REF               |       |

**SOD-523 Suggested Pad Layout**

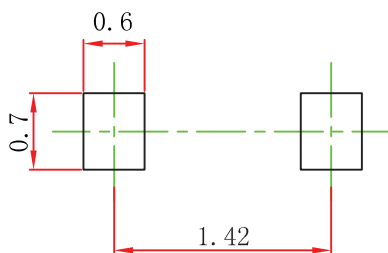

- Note:
1. Controlling dimension: In millimeters.
  2. General tolerance: ± 0.05mm.
  3. The pad layout is for reference purposes only.

**NOTICE**

JCET reserve the right to make modifications, enhancements, improvements, corrections or other changes without further notice to any product herein. JCET does not assume any liability arising out of the application or use of any product described herein.

**TAPE AND REEL INFORMATION**

**SOD-523 Embossed Carrier Tape**

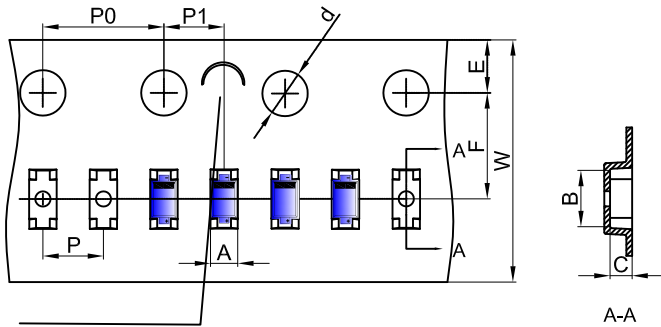

**Packaging Description:**

SOD-523 parts are shipped in tape. The carrier tape is made from a dissipative (carbon filled) polycarbonate resin. The cover tape is a multilayer film (Heat Activated Adhesive in nature) primarily composed of polyester film, adhesive layer, sealant, and anti-static sprayed agent. These reeled parts in standard option are shipped with 8,000 units per 7" or 17.8cm diameter reel. The reels are clear in color and is made of polystyrene plastic (anti-static coated).

NOTE: TO GAVE 'C' ON CARRIER TAPE PER 120MM

| Dimensions are in millimeter |     |      |      |       |      |      |      |      |      |      |
|------------------------------|-----|------|------|-------|------|------|------|------|------|------|
| Pkg type                     | A   | B    | C    | d     | E    | F    | P0   | P    | P1   | W    |
| SOD-523                      | 0.9 | 1.94 | 0.73 | Ø1.50 | 1.75 | 3.50 | 4.00 | 2.00 | 2.00 | 8.00 |

**SOD-523 Tape Leader and Trailer**

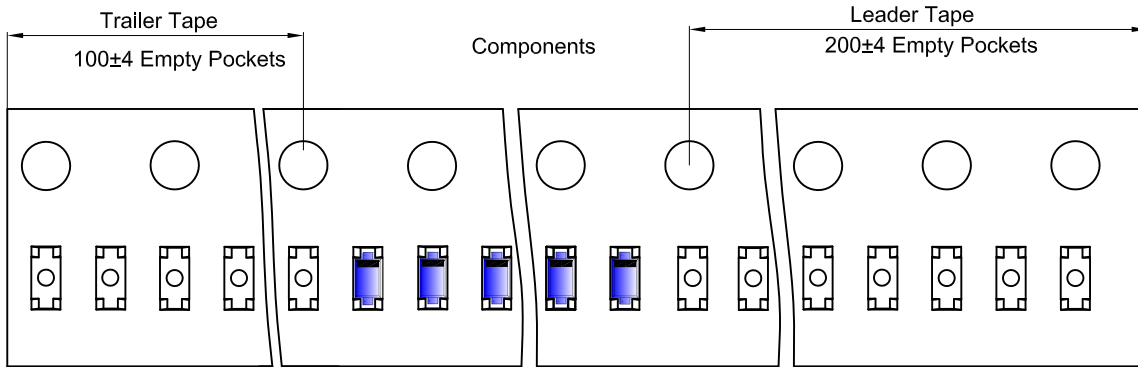

**SOD-523 Reel**

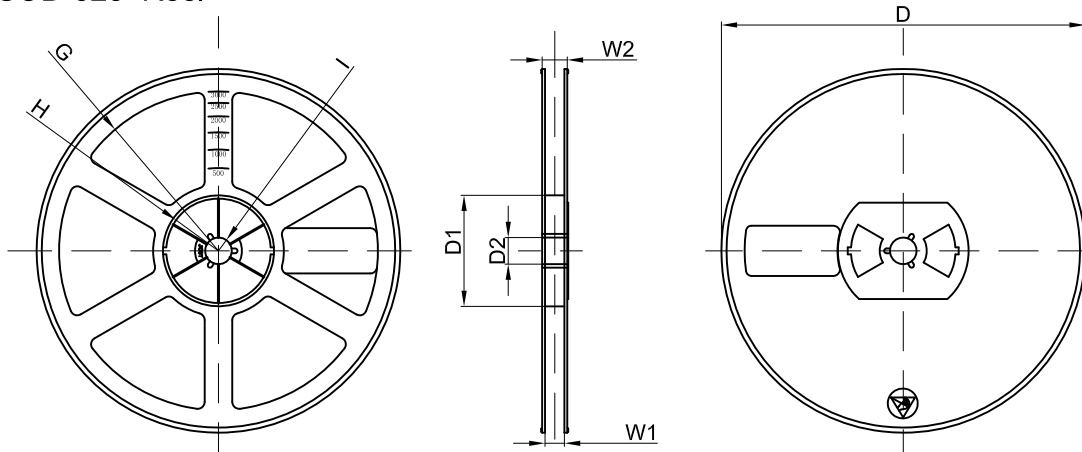

| Dimensions are in millimeter |         |       |       |        |        |       |      |       |
|------------------------------|---------|-------|-------|--------|--------|-------|------|-------|
| Reel Option                  | D       | D1    | D2    | G      | H      | I     | W1   | W2    |
| 7" Dia                       | Ø178.00 | 54.40 | 13.00 | R78.00 | R25.60 | R6.50 | 9.50 | 12.30 |

| REEL     | Reel Size | Box         | Box Size(mm) | Carton      | Carton Size(mm) | G.W.(kg) |
|----------|-----------|-------------|--------------|-------------|-----------------|----------|
| 8000 pcs | 7 inch    | 120,000 pcs | 203×203×195  | 480,000 pcs | 438×438×220     |          |

## X-ON Electronics

Largest Supplier of Electrical and Electronic Components

*Click to view similar products for [ESD Suppressors / TVS Diodes](#) category:*

*Click to view products by [Changjiang](#) manufacturer:*

Other Similar products are found below :

[NTE4902](#) [P4SMAJ15A](#) [P4SMAJ26A](#) [SMAJ400CA-TP](#) [TGL34-47CA](#) [ESDAULC45-1BF4](#) [SM1605E3/TR13](#) [SMF20A-TP](#) [P4SMAJ12A](#)  
[CPDUR24V-HF](#) [CPDQC5V0USP-HF](#) [CPDQC5V0-HF](#) [MPLAD30KP45CAE3](#) [MMBZ27VCLQ-7-F](#) [MMAD1108/TR13](#) [MPLAD30KP24A](#)  
[ACPDQC5V0R-HF](#) [DFLT170A-7](#) [NTE4900](#) [NTE4926](#) [NTE4938](#) [SMF22A-TP](#) [SMF12A-TP](#) [SLVU2.8-TP](#) [SMLJ6.5CA-TP](#) [SMAJ6.5CA-](#)  
[TP](#) [MMAD1108E3/TR13](#) [D5V0M1U2LP3-7](#) [SMAJ400A-TP](#) [AOZ8811DT-03](#) [AOZ8831DI-05](#) [AOZ8831DT-03](#) [SMAJ188CA](#) [3SMC33CA](#)  
[BK](#) [CPDQC3V3C-HF](#) [CPDQC12VE-HF](#) [MPLAD30KP170CA](#) [82357120100](#) [5.0SMLJ15CA-TP](#) [5KP18A-TP](#) [P6KE8.2A-TP](#)  
[MPLAD30KP43CAE3](#) [SMAJ43A-TP](#) [D5V0F6U8LP33-7](#) [TVS5501V10MUT5G](#) [5.0SMLJ24CA-TP](#) [SMAJ110CA-TP](#) [MPLAD15KP75CAE3](#)  
[MMAD1103e3/TR13](#) [DFLT40AQ-7](#)