

KHz RANGE CRYSTAL UNIT



Product Number (please contact us)
 FC-135R : X1A000141xxxx00
 FC-135 : Q1xFC1350xxxx00

FC-135R / FC-135

- Frequency range : 32.768 kHz (32 kHz to 100 kHz)
- External dimensions : 3.2 x 1.5 x 0.80 mm ...FC-135R/FC-135
- Overtone order : Fundamental
- Applications : Small communications devices

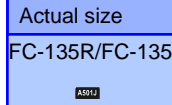

Specifications (characteristics)

| Item | Symbol | Specifications | | | Conditions / Remarks |
|--------------------------------|--------|---|-------------|--------------------|---|
| | | FC-135R | FC-135 | | |
| Nominal frequency range | f_nom | 32.768 kHz | 32.768 kHz | 32 kHz to 77.5 kHz | Please contact us about available frequencies. |
| Storage temperature | T_stg | -55 °C to +125 °C | | | Storage as single product. |
| Operating temperature | T_use | -40 °C to +85 °C (+105 °C) | | | Please contact us about +85 °C < T_use |
| Level of drive | DL | 0.5 μW (1.0 μW Max.) | | | Please contact us if you require 1.0μW Max. |
| Frequency tolerance (standard) | f_tol | ±20 × 10 ⁻⁶ | | | +25 °C, DL=0.1 μW Please ask for tighter tolerance |
| Turnover temperature | Ti | +25 °C ±5 °C | | | |
| Parabolic coefficient | B | -0.04 × 10 ⁻⁶ / °C ² Max. | | | |
| Load capacitance | CL | 7 pF, 9 pF, 12.5 pF | | | Please specify |
| Motional resistance (ESR) | R1 | 50 kΩ Max. | 70 kΩ Max. | 70 kΩ to 45 kΩ | |
| Motional capacitance | C1 | 3.4 fF Typ. | 3.4 fF Typ. | 3.7 fF to 1.6 fF | |
| Shunt capacitance | C0 | 1.1 pF Typ. | 1.0 pF Typ. | 1.3 pF to 0.5 pF | |
| Frequency aging | f_age | ±3 × 10 ⁻⁶ / year Max. | | | +25 °C, First year |

Product name FC-135R 32.768000kHz 12.5 +20.0-20.0
 (Standard form) ① ② ③ ④

①Model ②Frequency ③Load capacitance(pF) ④Frequency tolerance(x 10⁻⁶, +25 °C)

External dimensions

(Unit:mm)

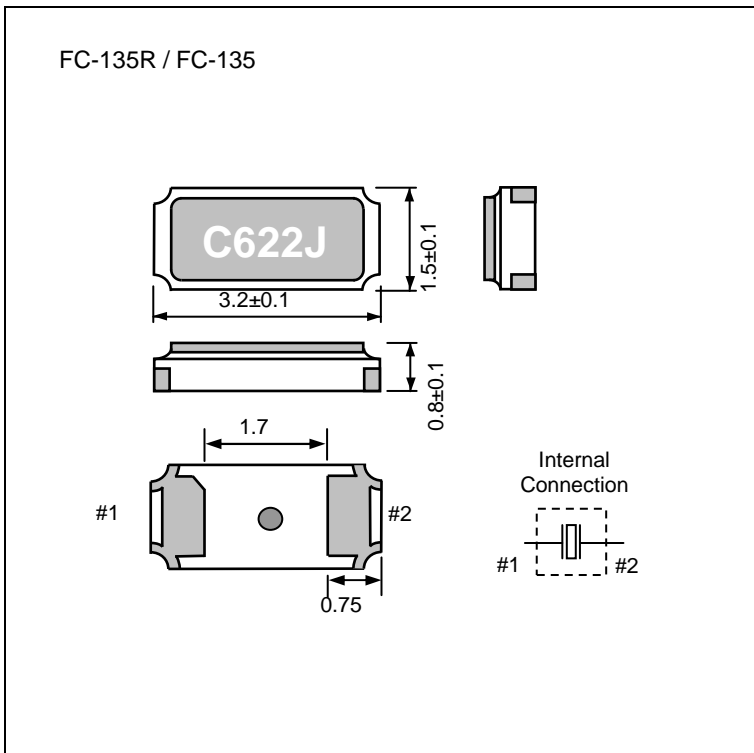

Footprint (Recommended)

(Unit:mm)

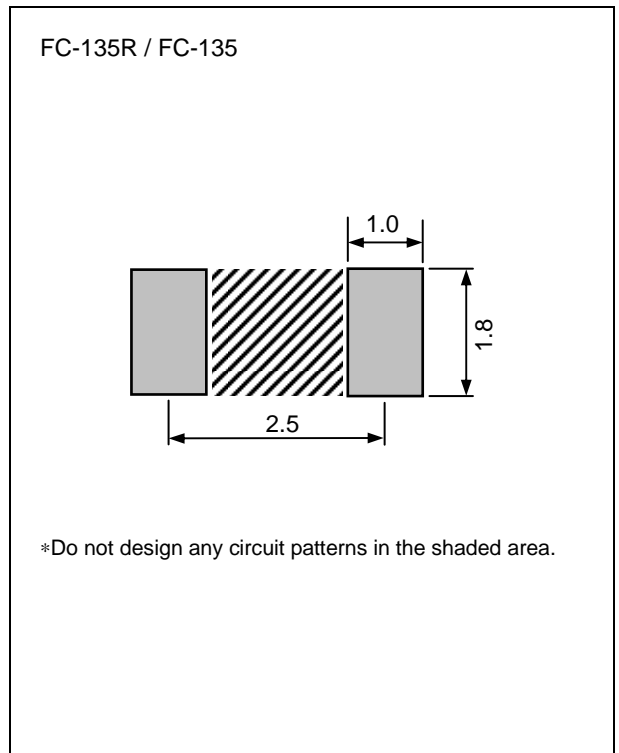

PROMOTION OF ENVIRONMENTAL MANAGEMENT SYSTEM CONFORMING TO INTERNATIONAL STANDARDS

At Seiko Epson, all environmental initiatives operate under the Plan-Do-Check-Action (PDCA) cycle designed to achieve continuous improvements. The environmental management system (EMS) operates under the ISO 14001 environmental management standard.

All of our major manufacturing and non-manufacturing sites, in Japan and overseas, completed the acquisition of ISO 14001 certification.

ISO 14000 is an international standard for environmental management that was established by the International Standards Organization in 1996 against the background of growing concern regarding global warming, destruction of the ozone layer, and global deforestation.





WORKING FOR HIGH QUALITY

In order provide high quality and reliable products and services than meet customer needs,

Seiko Epson made early efforts towards obtaining ISO9000 series certification and has acquired ISO9001 for all business establishments in Japan and abroad. We have also acquired ISO/TS 16949 certification that is requested strongly by major automotive manufacturers as standard.

ISO/TS16949 is the international standard that added the sector-specific supplemental requirements for automotive industry based on ISO9001.

► Explanation of the mark that are using it for the catalog

| | |
|---|---|
|  | ► Pb free. |
|  | ► Complies with EU RoHS directive. *About the products without the Pb-free mark. Contains Pb in products exempted by EU RoHS directive. (Contains Pb in sealing glass, high melting temperature type solder or other.) |
|  | ► Designed for automotive applications such as Car Multimedia, Body Electronics, Remote Keyless Entry etc. |
|  | ► Designed for automotive applications related to driving safety (Engine Control Unit, Air Bag, ESC etc.) |

Notice

- This material is subject to change without notice.
- Any part of this material may not be reproduced or duplicated in any form or any means without the written permission of Seiko Epson.
- The information about applied circuitry, software, usage, etc. written in this material is intended for reference only. Seiko Epson does not assume any liability for the occurrence of infringing on any patent or copyright of a third party. This material does not authorize the licensing for any patent or intellectual copyrights.
- When exporting the products or technology described in this material, you should comply with the applicable export control laws and regulations and follow the procedures required by such laws and regulations.
- You are requested not to use the products (and any technical information furnished, if any) for the development and/or manufacture of weapon of mass destruction or for other military purposes. You are also requested that you would not make the products available to any third party who may use the products for such prohibited purposes.
- These products are intended for general use in electronic equipment. When using them in specific applications that require extremely high reliability, such as the applications stated below, you must obtain permission from Seiko Epson in advance.
/ Space equipment (artificial satellites, rockets, etc.) / Transportation vehicles and related (automobiles, aircraft, trains, vessels, etc.) / Medical instruments to sustain life / Submarine transmitters / Power stations and related / Fire work equipment and security equipment / traffic control equipment / and others requiring equivalent reliability.
- All brands or product names mentioned herein are trademarks and/or registered trademarks of their respective.

X-ON Electronics

Largest Supplier of Electrical and Electronic Components

Click to view similar products for [Crystals](#) category:

Click to view products by [Seiko](#) manufacturer:

Other Similar products are found below :

[CS325S24000000ABJT](#) [718-13.2-1](#) [MC405 32.0000K-R3:PURE SN](#) [FC-135R 32.7680KF-A3](#) [7A-40.000MAAE-T](#) [7B-27.000MBBK-T](#)
[FL2000085](#) [9B-15.360MBBK-B](#) [9C-7.680MBBK-T](#) [ASH7K-32.768KHZ](#) [AT-41.600MAGQ-T](#) [BTD1062E05A-513](#) [LFX TAL066198Cutt](#)
[9C-14.31818MBBK-T](#) [FA-238 50.0000MB30X-K3](#) [FC-12M 32.7680KA-AC3](#) [SSPT7F-9PF20-R](#) [FX325BS-38.88EEM1201](#)
[LFX TAL065253Cutt](#) [LFX TAL066431Cutt](#) [XT9S20ANA14M7456](#) [XT9SNLANA16M](#) [646G-24-2](#) [7A-24.576MBBK-T](#) [7B-30.000MBBK-T](#)
[WX26-32.768K-6PF](#) [9B-14.31818MBBK-B](#) [CD1AM](#) [7B-25.000MAAE-T](#) [7A-14.31818MBBK-T](#) [6504-202-1501](#) [6526-202-1501](#) [FA-118T](#)
[27.1200MB50P-K0](#) [FC-135R 32.7680KA-A3](#) [ABM12-104-37.400MHZT](#) [ABLS-10.000MHZ-D3W-T](#) [BTJ112E01E-513](#) [BTJ722K01C-7067](#)
[BTL-20-513](#) [TSX-3225 24.0000MF15X-AC](#) [TSX-3225 16.0000MF18X-AC](#) [BTJ120E02C](#) [BTL-12-513](#) [7A-10.000MBBK-T](#) [7A-](#)
[11.0592MBBK-T](#) [ABM12-103-24.000MHZT](#) [CS325S25000000ABJT](#) [ABM3B-25.000MHZ-B2-X-T](#) [FC-135 32.7680KA-A5](#) [FX0800015](#)