



**SOT-23 Plastic-Encapsulate MOSFETS**

**CJ2302S** N-Channel 20-V(D-S) MOSFET

$V_{(BR)DSS}$	$R_{DS(on)MAX}$	$I_D$
20V	60mΩ@4.5V	2.1A
	115mΩ@2.5V	

SOT-23

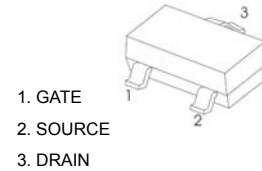

**FEATURE**

- TrenchFET Power MOSFET

**APPLICATION**

- Load Switch for Portable Devices
- DC/DC Converter

**MARKING**

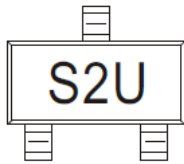

**Equivalent Circuit**

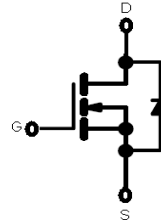

**Maximum ratings ( $T_a=25^{\circ}C$  unless otherwise noted)**

Parameter	Symbol	Value	Unit
Drain-Source Voltage	$V_{DS}$	20	V
Gate-Source Voltage	$V_{GS}$	±8	
Continuous Drain Current ( $T_J=150^{\circ}C$ )	$I_D$	2.1	A
Pulsed Drain Current	$I_{DM}$	10	
Continuous Source-Drain Current(Diode Conduction)	$I_S$	0.6	
Power Dissipation	$P_D$	0.35	W
Thermal Resistance from Junction to Ambient ( $t \leq 5s$ )	$R_{\theta JA}$	357	$^{\circ}C/W$
Operating Junction	$T_J$	150	$^{\circ}C$
Storage Temperature	$T_{STG}$	-55 ~ +150	

## MOSFET ELECTRICAL CHARACTERISTICS

$T_a=25^\circ\text{C}$  unless otherwise specified

Parameter	Symbol	Test Condition	Min	Typ	Max	Units
<b>Static</b>						
Drain-source breakdown voltage	$V_{(BR)DSS}$	$V_{GS} = 0V, I_D = 10\mu A$	20			V
Gate-threshold voltage	$V_{GS(th)}$	$V_{DS} = V_{GS}, I_D = 50\mu A$	0.65	0.95	1.2	
Gate-body leakage	$I_{GSS}$	$V_{DS} = 0V, V_{GS} = \pm 8V$			$\pm 100$	nA
Zero gate voltage drain current	$I_{DSS}$	$V_{DS} = 20V, V_{GS} = 0V$			1	$\mu A$
Drain-source on-resistance <sup>a</sup>	$r_{DS(on)}$	$V_{GS} = 4.5V, I_D = 3.6A$		0.035	0.060	$\Omega$
		$V_{GS} = 2.5V, I_D = 3.1A$		0.045	0.115	
Forward transconductance <sup>a</sup>	$g_{fs}$	$V_{DS} = 5V, I_D = 3.6A$		8		S
Diode forward voltage	$V_{SD}$	$I_S = 0.94A, V_{GS} = 0V$		0.76	1.2	V
<b>Dynamic</b>						
Total gate charge	$Q_g$	$V_{DS} = 10V, V_{GS} = 4.5V, I_D = 3.6A$		4.0	10	nC
Gate-source charge	$Q_{gs}$			0.65		
Gate-drain charge	$Q_{gd}$			1.5		
Input capacitance	$C_{iss}$	$V_{DS} = 10V, V_{GS} = 0V, f = 1MHz$		300		pF
Output capacitance	$C_{oss}$			120		
Reverse transfer capacitance	$C_{rss}$			80		
<b>Switching</b>						
Turn-on delay time	$t_{d(on)}$	$V_{DD} = 10V,$ $R_L = 5.5\Omega, I_D \approx 3.6A,$ $V_{GEN} = 4.5V, R_g = 6\Omega$		7	15	ns
Rise time	$t_r$			55	80	
Turn-off delay time	$t_{d(off)}$			16	60	
Fall time	$t_f$			10	25	

**Notes :**

a. Pulse Test : Pulse width  $\leq 300\mu s$ , duty cycle  $\leq 2\%$ .

# Typical Characteristics

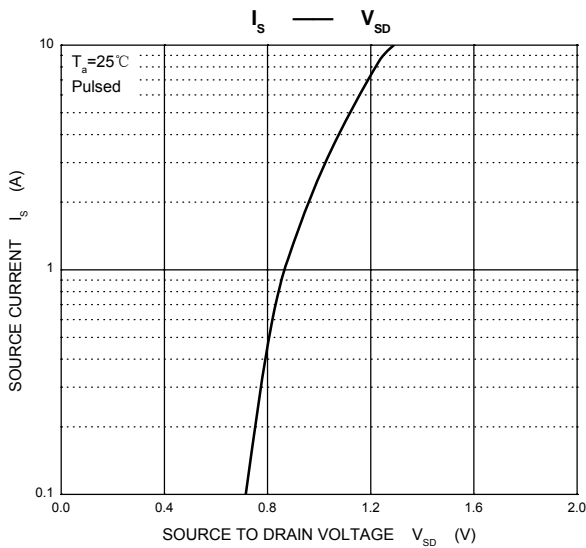
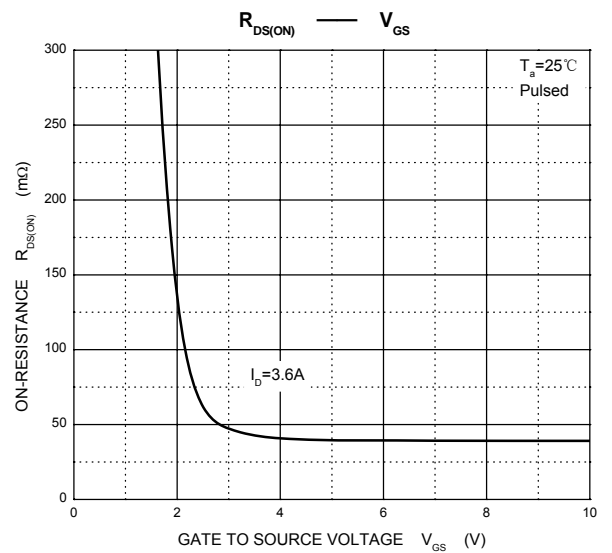
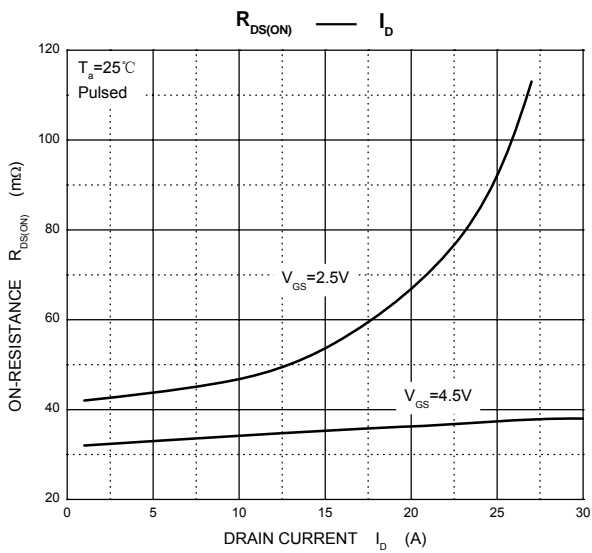
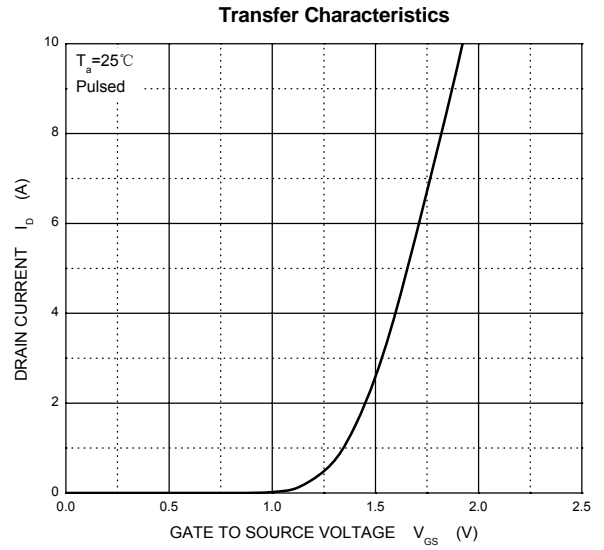
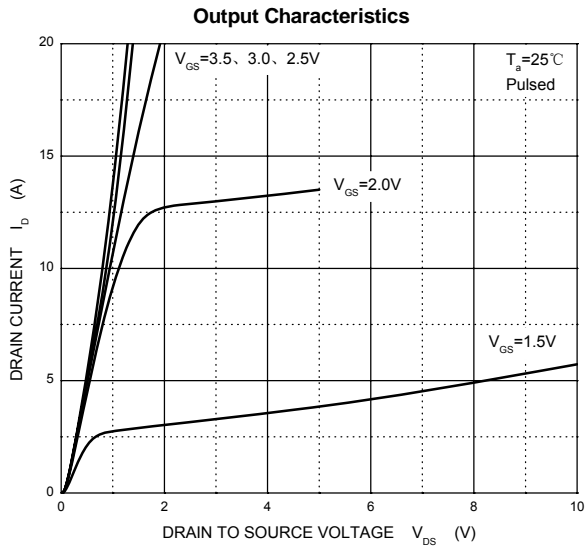

## SOT-23 Package Outline Dimensions



Symbol	Dimensions In Millimeters		Dimensions In Inches	
	Min	Max	Min	Max
A	0.900	1.150	0.035	0.045
A1	0.000	0.100	0.000	0.004
A2	0.900	1.050	0.035	0.041
b	0.300	0.500	0.012	0.020
c	0.080	0.150	0.003	0.006
D	2.800	3.000	0.110	0.118
E	1.200	1.400	0.047	0.055
E1	2.250	2.550	0.089	0.100
e	0.950 TYP		0.037 TYP	
e1	1.800	2.000	0.071	0.079
L	0.550 REF		0.022 REF	
L1	0.300	0.500	0.012	0.020
θ	0°	8°	0°	8°

## SOT-23 Suggested Pad Layout



- Note:
1. Controlling dimension: in millimeters.
  2. General tolerance:  $\pm 0.05\text{mm}$ .
  3. The pad layout is for reference purposes only.

### NOTICE

JCET reserve the right to make modifications, enhancements, improvements, corrections or other changes without further notice to any product herein. JCET does not assume any liability arising out of the application or use of any product described herein.

# SOT-23 Tape and reel

## SOT-23 Embossed Carrier Tape

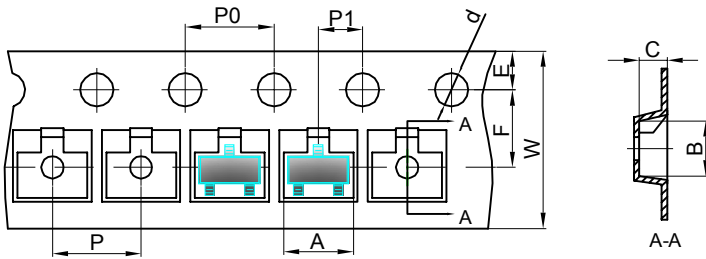

**Packaging Description:**  
 SOT-23 parts are shipped in tape. The carrier tape is made from a dissipative (carbon filled) polycarbonate resin. The cover tape is a multilayer film (Heat Activated Adhesive in nature) primarily composed of polyester film, adhesive layer, sealant, and anti-static sprayed agent. These reeled parts in standard option are shipped with 3,000 units per 7" or 17.8cm diameter reel. The reels are clear in color and is made of polystyrene plastic (anti-static coated).

Dimensions are in millimeter										
Pkg type	A	B	C	d	E	F	P0	P	P1	W
SOT-23	3.15	2.77	1.22	Ø1.50	1.75	3.50	4.00	4.00	2.00	8.00

## SOT-23 Tape Leader and Trailer

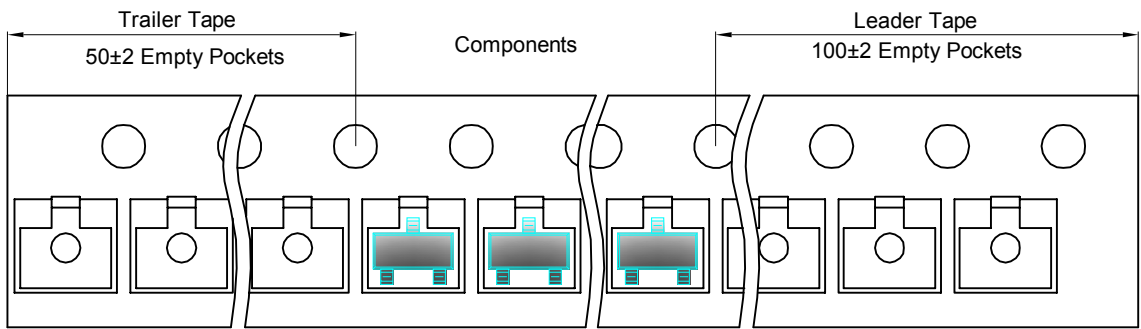

## SOT-23 Reel

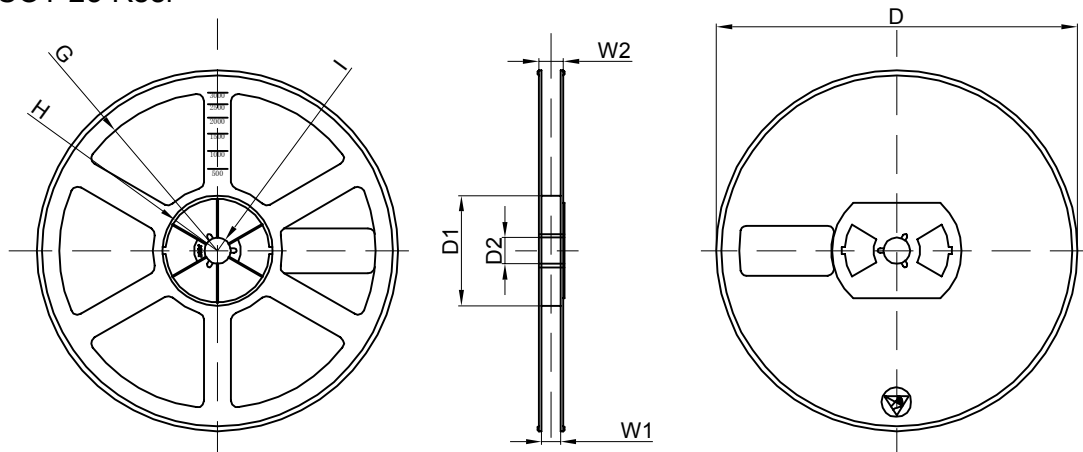

Dimensions are in millimeter								
Reel Option	D	D1	D2	G	H	I	W1	W2
7" Dia	Ø178.00	54.40	13.00	R78.00	R25.60	R6.50	9.50	12.30

REEL	Reel Size	Box	Box Size(mm)	Carton	Carton Size(mm)	G.W.(kg)
3000 pcs	7 inch	30,000 pcs	203×203×195	120,000 pcs	438×438×220	

## X-ON Electronics

Largest Supplier of Electrical and Electronic Components

*Click to view similar products for [MOSFET](#) category:*

*Click to view products by [Changjiang](#) manufacturer:*

Other Similar products are found below :

[614233C](#) [648584F](#) [MCH3443-TL-E](#) [MCH6422-TL-E](#) [FDPF9N50NZ](#) [FW216A-TL-2W](#) [FW231A-TL-E](#) [APT5010JVR](#) [NTNS3A92PZT5G](#)  
[IRF100S201](#) [JANTX2N5237](#) [2SK2464-TL-E](#) [2SK3818-DL-E](#) [FCA20N60\\_F109](#) [FDZ595PZ](#) [STD6600NT4G](#) [FSS804-TL-E](#) [2SJ277-DL-E](#)  
[2SK1691-DL-E](#) [2SK2545\(Q,T\)](#) [405094E](#) [423220D](#) [MCH6646-TL-E](#) [TPCC8103,L1Q\(CM](#) [367-8430-0972-503](#) [VN1206L](#) [424134F](#)  
[026935X](#) [051075F](#) [SBVS138LT1G](#) [614234A](#) [715780A](#) [NTNS3166NZT5G](#) [751625C](#) [873612G](#) [IRF7380TRHR](#) [IPS70R2K0CEAKMA1](#)  
[RJK60S3DPP-E0#T2](#) [RJK60S5DPK-M0#T0](#) [APT5010JVFR](#) [APT12031JFLL](#) [APT12040JVR](#) [DMN3404LQ-7](#) [NTE6400](#) [JANTX2N6796U](#)  
[JANTX2N6784U](#) [JANTXV2N5416U4](#) [SQM110N05-06L-GE3](#) [SIHF35N60E-GE3](#) [2SK2614\(TE16L1,Q\)](#)