

Part Numbering System



① Category code

Type	Code
	1
Electrolytic Capacitor	E
Conductive Polymer	S

② Series code

Series name	Code	
	2	3
WH	W	H
CD11GE	G	E
CD11GES	G	X
CD11GAS	G	W
CD11GHS	G	S
NR	N	R
PZ	P	Z

③ Voltage code

WV (V _{dc})	Code	
	4	5
2.5	0	E
3	0	D
4	0	G
6.3	0	J
6.8	0	C
7	0	Q
7.5	0	A
10	1	A
12	1	T
16	1	C
25	1	E
35	1	V
40	1	G
50	1	H
63	1	J
80	1	B
100	1	K
120	2	B
160	2	C
180	2	L
200	2	D
220	2	N
250	2	E
315	2	F
350	2	V
380	2	P
400	2	G
420	2	T
450	2	W
500	2	H
550	2	J
600	2	K

④ Capacitance tolerance code

Tol. (%)	Code
	6
-10~+10	K
-20~+20	M
-10~+30	Q
-10~+20	V
0~+20	A
-5~+20	C
-10~-20	B
-5~+5	D
0~+10	E
-5~-20	F
-15~+5	N

⑤ Capacitance code

Cap (μF)	Code		
	7	8	9
0.10	R	1	0
0.22	R	2	2
0.33	R	3	3
0.47	R	4	7
0.68	R	6	8
1	0	1	0
2.2	2	R	2
3.3	3	R	3
4.7	4	R	7
6.8	6	R	8
10	1	0	0
22	2	2	0
33	3	3	0
47	4	7	0
68	6	8	0
100	1	0	1
220	2	2	1
330	3	3	1
470	4	7	1
680	6	8	1
1000	1	0	2
2200	2	2	2
3300	3	3	2
4700	4	7	2
6800	6	8	2
10000	1	0	3
22000	2	2	3
33000	3	3	3
68000	6	8	3

⑥ Size code

ΦD (mm)	Code
4	C
5	D
6.3	E
8	F
10	G
11	H
12	J
12.5	W
13	K
14	X
16	L
18	M
19	Z
20	N
22	O
25	P
30	Q
35	R
40	Y
51.6	S
64.3	T
76.9	U
91	V
100	A

L (mm)	Code	
	11	12
5	0	5
7	0	7
11	1	1
12	1	2
16	1	6
20	2	0
25	2	5
30	3	0
35	3	5
40	4	0
46	4	6
50	5	0
60	6	0
80	8	0
100	A	0
115	B	5
120	C	0
130	D	0
140	E	0
160	G	0
200	K	0
220	M	0
236	N	6
250	P	0

⑦ Terminal code

Specification	Code	Size	
	13	14	15
Bulk packing	O	-	-
Taping (SMD Type)	D	0	0
Φ4~8 Taping F=5.0mm	P	5	0
Φ10~12.5 Taping F=5.0mm	B	5	0
Lead Cut L=3.5mm	C	3	5
Lead Cut L=11.0mm	C	B	0
Lead Forming & Cut L=4.5mm	F	-	-
Kink & Cut L=4.5mm	J	-	-
Snap-in type Terminal 4.0mm in length	K	-	-
Three Terminals	T	-	-
Ring clip mounting standard design	A	0	0
Ring clip mounting special design	S	-	-

⑧ Sleeve/Marking code

Sleeve/Marking	Code
	16
PVC	C
PET	T
Dark blue	B
Bright red	R
Sky-blue	S
Light blue	T
Pink	Z
Black	H
Purple-blue	V
Red	O

Lead Forming
Taping Specifications

Fig.1 code: X



Fig.2 code: B



Fig.3 code: B

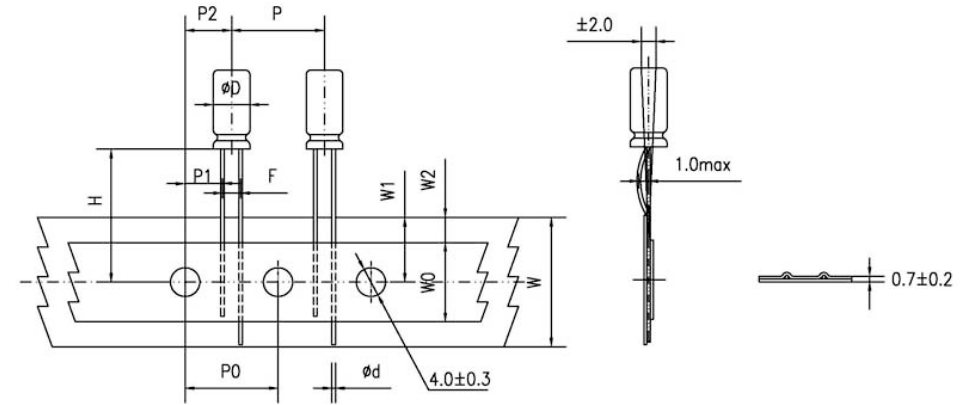

Fig.4 code: P



Lead Forming

Specification Fig.1 & Fig.2 & Fig.3

Items	Symbol	Case size										Tolerance		
		4*5 4*7		5*5 5*7		5*11		6.3*5	6.3*7 6.3*9	6.3*11 6.3*12	8*5/7 8*9/11 8*11.5 8*12		8*16 8*20	10*9/12 10*12.5 10*13/16 10*20/25
Pin Code		X	B	X	B	X	B	B	B	B	B	B	B	
Lead wire diameter	Φd	0.45		0.45		0.5		0.45	0.5	0.5	0.45/0.5	0.6	0.6	±0.05
Pitch of body	P	12.7		12.7		12.7		12.7	12.7	12.7	12.7	12.7	12.7	±1.0
Feed hole pitch	P0	12.7		12.7		12.7		12.7	12.7	12.7	12.7	12.7	12.7	±0.2
Distance from hole center to lead	P1	5.1	5.6	5.1	5.35	5.1	5.35	5.1	5.1	5.1	4.6	4.6	3.85	±0.7
Distance from feed hole center to body center	P2	6.35		6.35		6.35		6.35	6.35	6.35	6.35	6.35	6.35	±1.0
Lead-to-lead distance	F	2.5	1.5	2.5	2.0	2.5	2.0	2.5	2.5	2.5	3.5	3.5	5.0	±0.5
Height of body from tape center	H	18.5		18.5		18.5		18.5	18.5	18.5	18.5	18.5	18.5	±0.75
Base tape width	W	18.0		18.0		18.0		18.0	18.0	18.0	18.0	18.0	18.0	±0.5
Adhesive tape width	W0	6.0		6.0		6.0		6.0	6.0	8.0	8.0	8.0	11.0	min
Hole position	W1	9.0		9.0		9.0		9.0	9.0	9.0	9.0	9.0	9.0	+0.75 -0.5
Hole down tape position	W2	3.0		3.0		3.0		3.0	3.0	3.0	3.0	3.0	3.0	max

Specification Fig.4

Items	Symbol	Case size									Tolerance
		4*5 4*7	5*5	5*7	5*11	6.3*5	6.3*7 6.3*9	6.3*11 6.3*12	8*5/7 8*9/11 8*11.5/12	8*16 8*20	
Pin Code		P	P	P	P	P	P	P	P	P	
Lead wire diameter	Φd	0.45	0.45	0.45	0.5	0.45	0.5	0.5	0.45/0.5	0.6	±0.05
Pitch of body	P	12.7	12.7	12.7	12.7	12.7	12.7	12.7	12.7	12.7	±1.0
Feed hole pitch	P0	12.7	12.7	12.7	12.7	12.7	12.7	12.7	12.7	12.7	±0.2
Distance from hole center to lead	P1	3.85	3.85	3.85	3.85	3.85	3.85	3.85	3.85	3.85	±0.7
Distance from feed hole center to body center	P2	6.35	6.35	6.35	6.35	6.35	6.35	6.35	6.35	6.35	±1.0
Lead-to-lead distance	F	1.5	2.0	2.0	2.0	2.5	2.5	2.5	3.5	3.5	±0.5
Lead to lead distance	F1	5.0	5.0	5.0	5.0	5.0	5.0	5.0	5.0	5.0	+0.8 -0.2
Height of body from tape center	H	18.5	18.5	18.5	18.5	18.5	18.5	18.5	18.5	18.5	±0.75
Lead wire clinch height	H0	16.0	16.0	16.0	16.0	16.0	16.0	16.0	16.0	16.0	±0.5
Base tape width	W	18.0	18.0	18.0	18.0	18.0	18.0	18.0	18.0	18.0	±0.5
Adhesive tape width	W0	6.0	6.0	6.0	6.0	6.0	6.0	8.0	8.0	8.0	min
Hole position	W1	9.0	9.0	9.0	9.0	9.0	9.0	9.0	9.0	9.0	+0.75 -0.5
Hole down tape position	W2	3.0	3.0	3.0	3.0	3.0	3.0	3.0	3.0	3.0	max

Lead Forming

Lead Forming & Cut

Code:C
RANGE: $\Phi 4\sim\Phi 18$

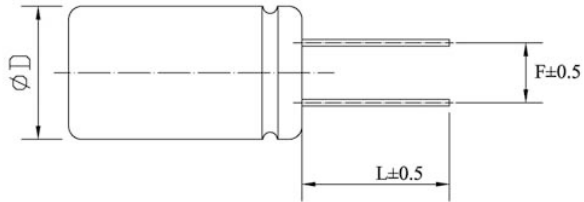

Code:F
RANGE: $\Phi 4\sim\Phi 8$

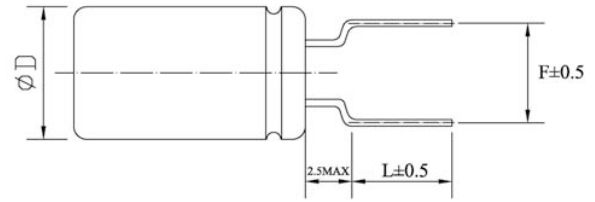

ΦD	F	L	ΦD	F	L
4	1.5	3.0~12.0	4	5.0	3.5, 4.5, 5.0, 7.0
5	2.0	3.0~12.0	5	5.0	3.5, 4.5, 5.0, 7.0
6.3	2.5	3.0~12.0	6.3	5.0	3.5, 4.5, 5.0, 7.0
8	3.5	3.0~12.0	8	5.0	3.5, 4.5, 5.0, 7.0
10	5.0	3.0~12.0	-	-	-
12.5	5.0	3.0~12.0	-	-	-
16	7.5	3.0~12.0	-	-	-
18	7.5	3.0~12.0	-	-	-

Code:J
RANGE: $\Phi 10\sim\Phi 18$



ΦD	F	L
10	5.0	4.0, 4.5, 5.0
12.5	5.0	4.0, 4.5, 5.0
16	7.5	4.0, 4.5, 5.0
18	7.5	4.0, 4.5, 5.0

Solering Recommendation

■ Flow Soldering(Radial Lead Type)

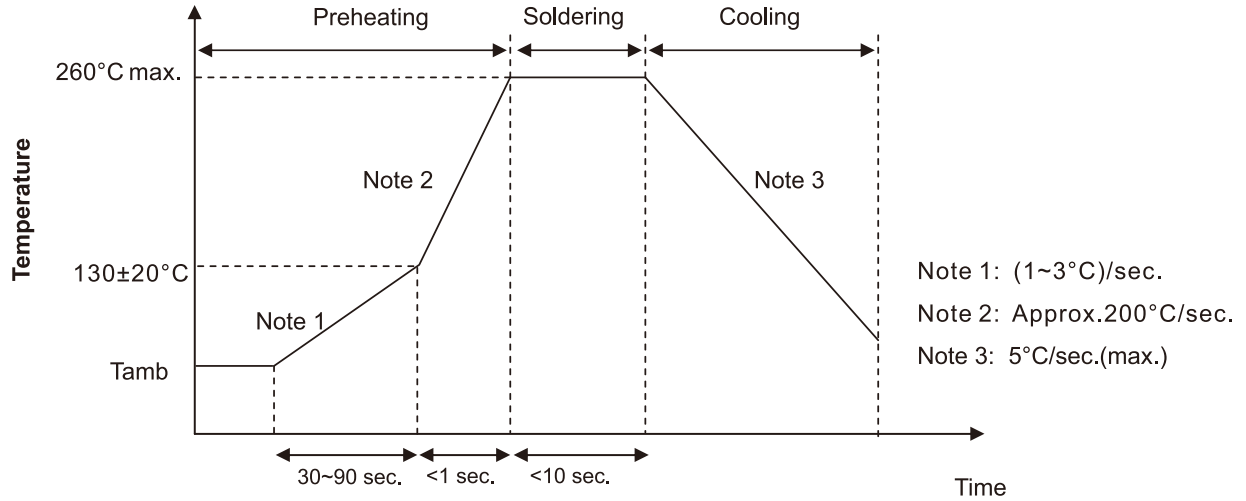

■ Reflow Soldering

- (For Polymer SMD Type)

Recommended Reflow Profile



Item	Preheating	T1(°C)	T2(°C)	T3(°C)	t1(sec.)	t2(sec.)	t3(sec.)	Reflow cycle
Condition 1	150°C to 180°C Within 90sec.	≤260	230	200	≤10	≤40	≤60	1
Condition 2		≤250	230	200	≤10	≤40	≤60	2

● (For Liquid SMD Type)

Case size: $\Phi 6.3$ – $\Phi 10$ mm:

- Temperature at surface of capacitor shall not exceed $T^{\circ}\text{C}$.
- The duration for over 200°C temperature and $T_1^{\circ}\text{C}$ at surface of capacitor shall not exceed t and t_1 seconds, respectively.
- Preheat shall be done at 100°C to 200°C and for Maximum 180 seconds.

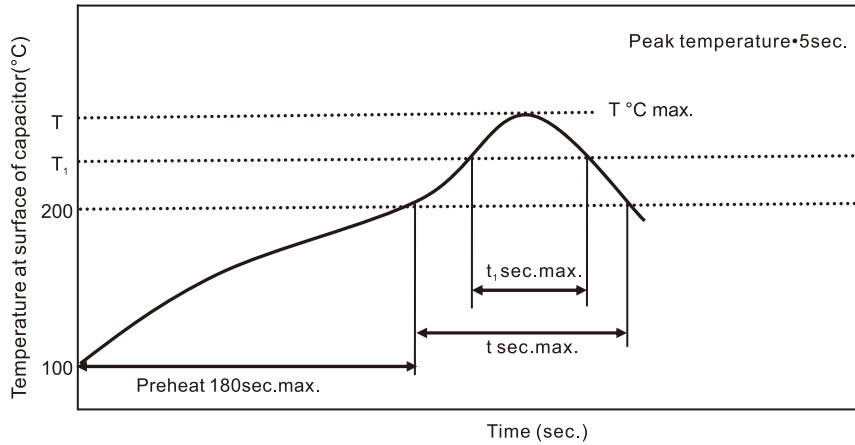

Case size (mm)	$T(^{\circ}\text{C})$ ①	$T_1(^{\circ}\text{C})$	$t(\text{sec.})$ ②	$t_1(\text{sec.})$ ③	Reflow cycle
$\Phi 6.3$	250	230	90	40	1
$\Phi 8$	240	230	90	30	1
$\Phi 10$	235	230	60	30	1

- ① Peak temperature
- ② The duration over 200°C (max.)
- ③ The duration over $T_1^{\circ}\text{C}$
- Please contact us if capacitors are subject to the conditions other than the allowable range of reflow.

Case size: $\Phi 12.5$ – $\Phi 18$ mm:

- Temperature at surface of capacitor shall not exceed $T^{\circ}\text{C}$.
- The duration for over 200°C temperature and $T_1^{\circ}\text{C}$ at surface of capacitor shall not exceed t and t_1 seconds, respectively.
- Preheat shall be done at 100°C to 180°C and for Maximum 150 seconds.

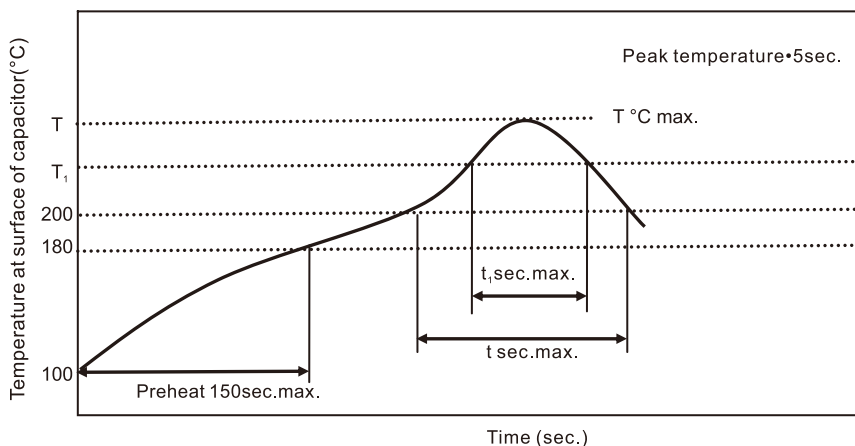

Case size (mm)	$T(^{\circ}\text{C})$ ①	$T_1(^{\circ}\text{C})$	$t(\text{sec.})$ ②	$t_1(\text{sec.})$ ③	Reflow cycle
$\Phi 12.5$ – $\Phi 18$	240	230	60	30	1

- ① Peak temperature
- ② The duration over 200°C (max.)
- ③ The duration over $T_1^{\circ}\text{C}$
- Please contact us if capacitors are subject to the conditions other than the allowable range of reflow.

RR series

- High frequency, low impedance, high reliability
- Endurance: +105°C 2,000 hours
- Suitable for switching power, UPS, power sources, etc.
- RoHS Compliant



SPECIFICATIONS

Items	Characteristics	
Category Temperature Range	-40~+105°C	
Rated Voltage Range	6.3~50 V _{dc}	
Capacitance Tolerance	±20%(M) (at 20°C, 120Hz)	
Leakage Current	I ≤ 0.01CV or 3μA, whichever is greater. Where, I: Max. leakage current (μA), C: Nominal capacitance (μF), V: Rated voltage (V) (at 20°C after 2 minutes)	
Dissipation Factor (tanδ)	Rated Voltage (V _{dc})	6.3 10 16 25 35 50
	tanδ (max.)	0.22 0.18 0.14 0.12 0.10 0.08
When nominal capacitance exceeds 1,000μF, add 0.02 to the value above for each 1,000μF increase. (at 20°C, 120Hz)		
Low Temperature Characteristics (Max. Impedance Ratio)	Rated Voltage (V _{dc})	6.3 10 16 25 35 50
	Z(-25°C)/Z(+20°C)	2 (at 120Hz)
Endurance	The specifications listed below shall be met when the capacitors are restored to 20°C after DC voltage plus rated ripple current is applied for 2,000 hours at 105°C.	
	Capacitance Change	≤±20% of the initial value (6.3, 10V: ≤±30%)
	D.F. (tanδ)	≤200% of the initial specified value
	Leakage Current	≤The initial specified value
Shelf Life	The following specifications shall be satisfied when the capacitors are restored to 20°C after leaving them under no load at 105°C for 1,000 hours.	
	Capacitance Change	≤±20% of the initial value (6.3, 10V: ≤±30%)
	D.F. (tanδ)	≤200% of the initial specified value
	Leakage Current	≤200% of the initial specified value

DIMENSIONS [mm]

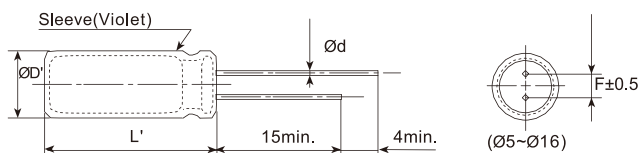

ØD	5	6.3	8	10	12.5	16
Ød	0.45	0.5	0.5	0.6	0.6	0.8
F	2.0	2.5	3.5	5.0	5.0	7.5
ØD'	ØD+0.5max.					
L'	L+2max.					

PART NUMBERING SYSTEM

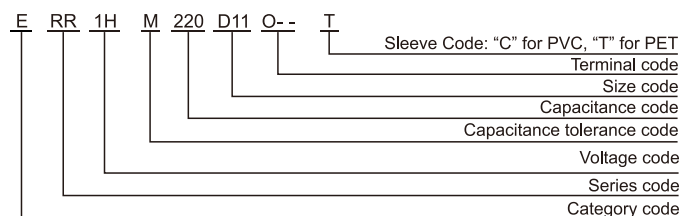

RATED RIPPLE CURRENT MULTIPLIERS

Frequency correction factor for ripple current

Freq.(Hz)	120	1k	10k	100k
Cap.<220	0.40	0.75	0.90	1.00
220≤Cap.<680	0.50	0.85	0.94	1.00
680≤Cap.<2200	0.60	0.87	0.95	1.00
2200≤Cap.<4700	0.75	0.90	0.95	1.00
Cap.≥4700	0.85	0.95	0.98	1.00

Radial Type

RR series

■ STANDARD RATINGS

WV (V _{dc})	Cap (μF)	Size ΦDxL(mm)	tanδ	Impedance (Ω _{max} /20°C, 100kHz)	Rated ripple current (mArms/105°C, 100kHz)
6.3(0J)	150	5*11	0.22	0.3	250
		6.3*7	0.22	0.3	250
	330	6.3*9	0.22	0.15	350
		6.3*11	0.22	0.13	405
	560	8*9	0.22	0.12	605
		8*12	0.22	0.072	760
	820	8*16	0.22	0.056	995
		10*9	0.22	0.085	800
	1000	10*12.5	0.22	0.053	1030
	1200	8*20	0.22	0.041	1250
		10*16	0.22	0.038	1430
	1500	10*20	0.22	0.023	1820
	2200	10*25	0.24	0.022	2150
	3300	12.5*20	0.26	0.021	2360
	3900	12.5*25	0.26	0.018	2770
	4700	12.5*30	0.28	0.016	3290
	5600	12.5*35	0.30	0.015	3400
		16*20	0.30	0.018	3140
6800	16*25	0.32	0.016	3460	
10(1A)	100	5*7	0.18	1.38	185
		5*11	0.18	0.3	250
	220	6.3*7	0.18	0.35	405
		6.3*11	0.18	0.13	405
	470	8*9	0.18	0.18	606
		8*11	0.18	0.072	760
	680	8*16	0.18	0.056	995
		10*9	0.18	0.085	760
	1000	10*12.5	0.18	0.053	1030
		8*20	0.18	0.041	1250
	1200	10*16	0.18	0.038	1430
		10*20	0.18	0.023	1820
	1500	10*25	0.18	0.022	2150
	2200	12.5*20	0.20	0.021	2360
	3300	12.5*25	0.22	0.018	2770
	3900	12.5*30	0.22	0.016	3290
		16*20	0.22	0.018	3140
	4700	12.5*35	0.24	0.015	3400
5600	16*25	0.26	0.016	3460	
16(1C)	56	5*7	0.14	0.7	180
		5*11	0.14	0.3	250
	120	6.3*7	0.14	0.4	300
		6.3*11	0.14	0.13	405
	330	8*7	0.14	0.14	510
		8*12	0.14	0.072	760
	470	8*16	0.14	0.056	795
		10*12.5	0.14	0.053	1030
	680	8*20	0.14	0.041	1250
		10*16	0.14	0.038	1430
	1000	10*20	0.14	0.023	1820
	1200	10*25	0.14	0.022	2150
	1500	12.5*20	0.14	0.021	2360
	2200	12.5*25	0.16	0.018	2770
	2700	12.5*30	0.16	0.016	3290
		16*20	0.16	0.018	3140
	3300	12.5*35	0.18	0.015	3400
	3900	16*25	0.18	0.016	3460

WV (V _{dc})	Cap (μF)	Size ΦDxL(mm)	tanδ	Impedance (Ω _{max} /20°C, 100kHz)	Rated ripple current (mArms/105°C, 100kHz)
25(1E)	47	5*11	0.12	0.3	250
		6.3*7	0.12	1.1	200
	100	6.3*11	0.12	0.13	405
		8*7	0.12	0.3	430
	220	8*9	0.12	0.1	600
		8*12	0.12	0.072	760
	330	8*16	0.12	0.056	995
	470	8*20	0.12	0.041	1250
	680	10*12.5	0.12	0.053	1030
	820	10*16	0.12	0.038	1430
		10*20	0.12	0.023	1820
	1500	10*25	0.12	0.022	2150
	1800	12.5*20	0.12	0.021	2360
		12.5*30	0.12	0.016	3290
	2200	16*20	0.12	0.018	3140
		12.5*25	0.14	0.018	2770
	2700	12.5*35	0.14	0.015	3400
		16*25	0.14	0.016	3460
35(1V)	33	5*7	0.10	1.15	160
		5*11	0.10	0.3	250
	56	6.3*11	0.10	0.13	405
		8*7	0.10	0.39	405
	150	8*9	0.10	0.17	600
		8*12	0.10	0.072	760
	220	8*16	0.10	0.056	995
		10*12.5	0.10	0.053	1030
	270	8*20	0.10	0.041	1250
	330	10*16	0.10	0.038	1430
	470	10*20	0.10	0.023	1820
	560	10*25	0.10	0.022	2150
	680	12.5*20	0.10	0.021	2360
	1000	12.5*25	0.10	0.018	2770
	1200	12.5*30	0.10	0.016	3290
		16*20	0.10	0.018	3140
	1500	12.5*35	0.10	0.015	3400
	1800	16*25	0.10	0.016	3460
50(1H)	22	5*11	0.08	0.34	238
		6.3*7	0.08	0.52	200
	56	6.3*12	0.08	0.14	385
		8*7	0.08	0.36	320
	100	8*9	0.08	0.2	580
		8*12	0.08	0.074	724
	120	8*16	0.08	0.061	950
	150	10*12.5	0.08	0.061	979
	180	8*20	0.08	0.046	1190
	220	10*16	0.08	0.042	1370
	270	10*20	0.08	0.03	1580
	330	10*25	0.08	0.028	1870
	470	12.5*20	0.08	0.027	2050
	560	12.5*25	0.08	0.023	2410
	680	12.5*30	0.08	0.021	2860
	820	12.5*35	0.08	0.019	2960
		16*20	0.08	0.023	2730
	1000	16*25	0.08	0.021	3010

X-ON Electronics

Largest Supplier of Electrical and Electronic Components

Click to view similar products for [Aluminium Electrolytic Capacitors - Radial Leaded](#) category:

Click to view products by [Aihua](#) manufacturer:

Other Similar products are found below :

[NRELS102M35V16X16C.140LLF](#) [ESRG160ETC100MD07D](#) [227RZS050M](#) [335CKR250M](#) [476CKH100MSA](#) [477CKR100M](#)
[107CKR010M](#) [107CKH063MSA](#) [RJH-25V222MI9#](#) [RJH-35V221MG5#](#) [B43827A1106M8](#) [RJH-50V221MH6#](#) [EKYA500ELL470MF11D](#)
[B41022A5686M6](#) [ESRG250ELL101MH09D](#) [EKMA160EC3101MF07D](#) [RJB-10V471MG3#](#) [ESMG160ETD221MF11D](#)
[EKZH160ETD152MJ20S](#) [RJH-35V122MJ6#](#) [EGXF630ELL621ML20S](#) [RBD-25V100KE3#N](#) [EKMA350ELL100ME07D](#)
[ESMG160ETD101ME11D](#) [ELXY100ETD102MJ20S](#) [EGXF500ELL561ML15S](#) [EKMG350ETD471MJ16S](#) [35YXA330MEFC10X12.5](#)
[RXW471M1ESA-0815](#) [ELXZ630ELL221MJ25S](#) [ERR1HM1R0D11OT](#) [LPE681M30060FVA](#) [LPL471M22030FVA](#) [HFE221M25030FVA](#)
[LKMD1401H221MF](#) [B41888G6108M000](#) [EKMA160ETD470MF07D](#) [UHW1J102MHD6](#) [EKMG500ETD221MJC5S](#) [LKMK2502W101MF](#)
[LKMD1401H181MF](#) [LKMI2502G820MF](#) [LKMJ2001J122MF](#) [LKML2501C472MF](#) [LKMJ4002C681MF](#) [450MXH330MEFCSN25X45](#)
[450MXK330MA2RFC22X50](#) [63ZLH560MEFCG412.5X30](#) [ELH2DM331O25KT](#) [ELH2DM471P30KT](#)