

Thick Film Chip Resistors Array Product Specification

1 Scope:

This specification is applicable to lead and halogen free RTA series thick film chip resistors array.

2 Explanation Of Part Numbers:

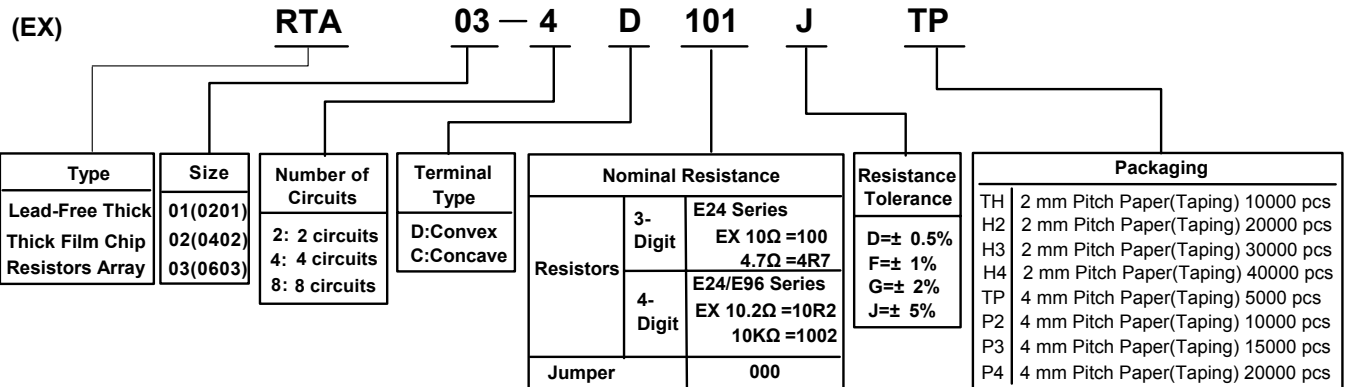

3 General Specifications:

Type	Rated Power at 70°C	Max. Working Voltage	Max. Overload Voltage	T.C.R. (ppm/°C)	Resistance Range			Number of Terminals	Number of Resistors	JUMPER (0Ω) Rated Current	JUMPER (0Ω) Resistance Value
					D(± 0.5%) E-24、E-96	F(± 1%) E-24、E-96	G(± 2%) J(± 5%) E-24				
RTA01-2D (0201)	1/32W	12.5V	25V	± 500	----	----	3Ω ≤ R < 10Ω	4	2	0.5A	50mΩ Max.
					----	----	10Ω ≤ R < 1KΩ				
					----	----	1KΩ ≤ R ≤ 1MΩ				
RTA02-2D (0402)	1/16W	25V	50V	± 300	----	1Ω ≤ R < 10Ω	1Ω ≤ R < 10Ω	4	2	1A	50mΩ Max.
					----	10Ω ≤ R ≤ 1MΩ	10Ω ≤ R ≤ 1MΩ				
RTA03-2D (0603)	1/16W	50V	100V	± 200	----	10Ω ≤ R ≤ 1MΩ	1Ω ≤ R ≤ 10MΩ	4	2	1A	50mΩ Max.
RTA02-4D (0402)	1/16W	25V	50V	± 300	----	1Ω ≤ R < 10Ω	1Ω ≤ R < 10Ω	8	4	1A	50mΩ Max.
					----	10Ω ≤ R ≤ 1MΩ	10Ω ≤ R ≤ 1MΩ				
RTA02-4C (0402)	1/16W	25V	50V	± 400	----	1Ω ≤ R < 10Ω	1Ω ≤ R < 10Ω	8	4	1A	50mΩ Max.
					----	10Ω ≤ R ≤ 1MΩ	10Ω ≤ R ≤ 1MΩ				
RTA03-4D (0603)	1/16W	50V	100V	± 200	22Ω ≤ R ≤ 470KΩ	1Ω ≤ R ≤ 10MΩ	1Ω ≤ R ≤ 10MΩ	8	4	1A	50mΩ Max.
RTA03-4C (0603)	1/16W	50V	100V	± 200	----	1Ω ≤ R ≤ 1MΩ	1Ω ≤ R ≤ 10MΩ	8	4	1A	50mΩ Max.
RTA02-8D (0402)	1/16W	25V	50V	± 250	----	10Ω ≤ R ≤ 1MΩ	1Ω ≤ R ≤ 1MΩ	16	8	1A	50mΩ Max.
RTA03-8C (0603)	1/16W	50V	100V	± 200	----	1Ω ≤ R ≤ 1MΩ	1Ω ≤ R ≤ 10MΩ	16	8	1A	50mΩ Max.
RTA03-2C (0603)	1/16W	50V	100V	± 200	----	1Ω ≤ R ≤ 1MΩ	1Ω ≤ R ≤ 10MΩ	4	2	1A	50mΩ Max.
RTA02-2C (0402)	1/16W	25V	50V	± 650	----	3Ω ≤ R < 10Ω	3Ω ≤ R < 10Ω	4	2	1A	50mΩ Max.
					± 250	10Ω ≤ R ≤ 1MΩ	10Ω ≤ R ≤ 1MΩ				

Operating Temperature Range

-55°C ~ +155°C

Approved

Checked

Written

Remark

IT'S NOT UNDER CONTROL FOR PDF FILE
PLS NOTE THE VERSION STATED.

Do not copy without permission

Issue Dep. DATA Center.

Series No. **60**

Thick Film Chip Resistors Array Product Specification

Document No.	IE-SP-011
Released Date	2011/02/20
Page No.	2/21

3.1 Power Derating Curve:

Operating Temperature Range : - 55~155 °C

For resistors operated in ambient temperatures above 70 °C , power rating shall be derated in accordance with figure below.

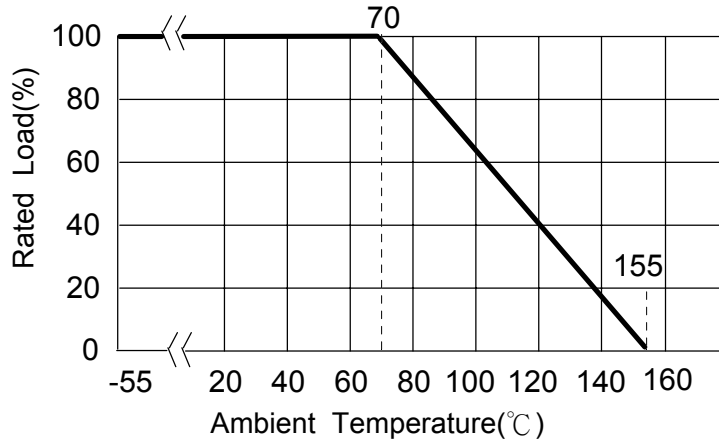

3.2 Voltage Rating:

Rated Voltage: The resistor shall have a DC continuous working voltage or a rms. AC continuous working voltage at commercial-line frequency and wave form corresponding to the power rating, as determined from the following:

$$E = \sqrt{R \times P}$$

- E= Rated voltage (v)**
- P= power rating (w)**
- R= Nominal resistance(Ω)**

Remark

IT' S NOT UNDER CONTROL FOR PDF FILE
PLS NOTE THE VERSION STATED.

Issue Dep. **DATA Center.**

Do not copy without permission

Series No. **60**

Thick Film Chip Resistors Array Product Specification

4 Dimensions: (mm)

RTA03-2D	RTA03-2C	Circuits
		<p style="text-align: center;">R1=R2</p>
RTA02-4C / RTA03-4C		Circuits
		<p style="text-align: center;">R1=R2=R3=R4</p>
RTA02-4D / RTA03-4D		

Remark

IT' S NOT UNDER CONTROL FOR PDF FILE
PLS NOTE THE VERSION STATED.

Do not copy without permission

Issue Dep. DATA Center.

Series No. **60**

Thick Film Chip Resistors Array Product Specification

RTA02-8D / RTA03-8C

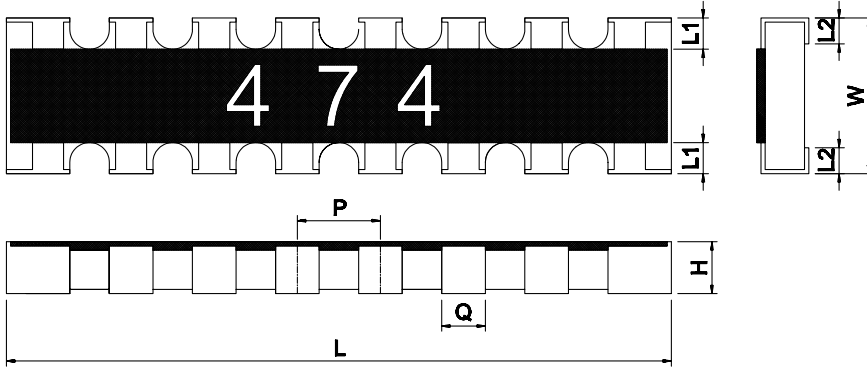

Circuits

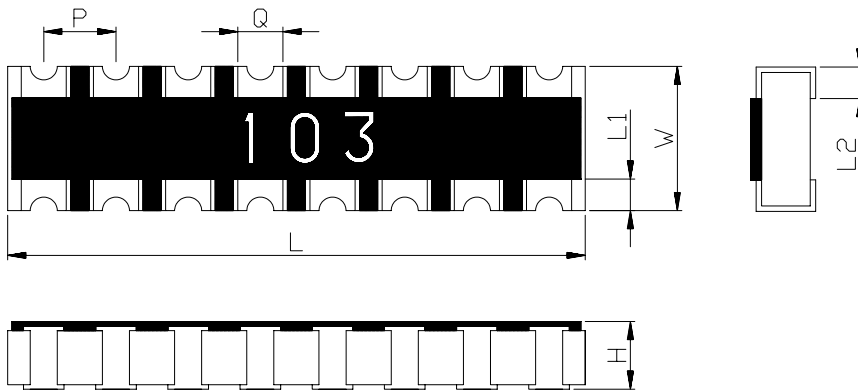
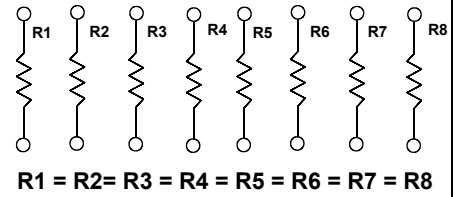

RTA01-2D / RTA02-2D

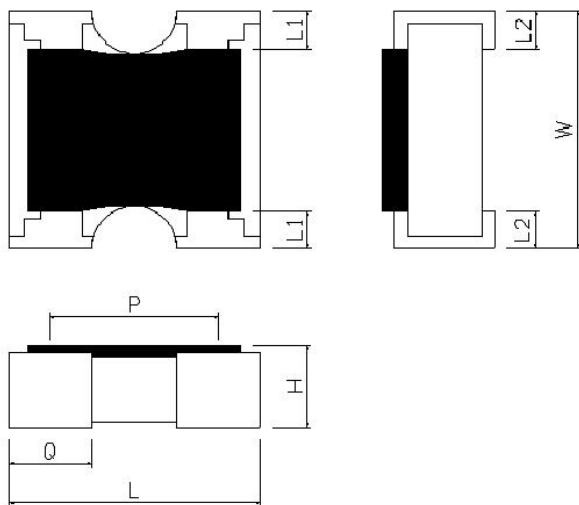

Circuits

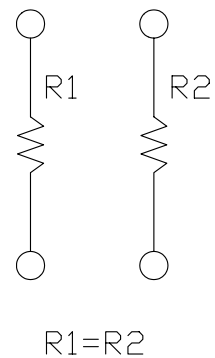

Remark

IT' S NOT UNDER CONTROL FOR PDF FILE
PLS NOTE THE VERSION STATED.

Issue Dep. DATA Center.

Do not copy without permission

Series No. **60**

Thick Film Chip Resistors Array Product Specification

RTA02-2C

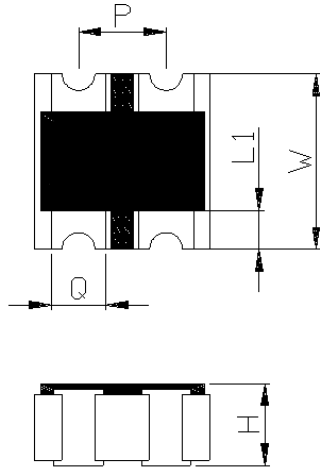

Circuits

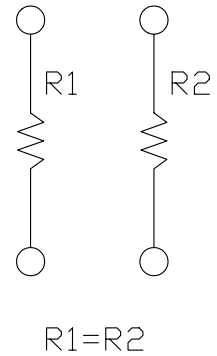

型式 \ 尺寸	L	W	H	L1	L2	P	Q
RTA01-2D (0201)	0.80± 0.10	0.60± 0.10	0.30± 0.05	0.15± 0.10	0.15± 0.05	(0.50)	0.35± 0.10
RTA02-2D (0402)	1.00± 0.10	1.00± 0.10	0.30± 0.05	0.15± 0.10	0.25± 0.10	(0.67)	0.33± 0.10
RTA03-2D (0603)	1.60± 0.15	1.60± 0.15	0.45± 0.10	0.30± 0.15	0.30± 0.15	(0.80)	0.60± 0.10
RTA02-4D (0402)	2.00± 0.10	1.00± 0.10	0.40± 0.10	0.20± 0.10	0.25± 0.10	(0.50)	0.30± 0.10
RTA02-4C (0402)	2.00± 0.10	1.00± 0.10	0.40± 0.10	0.15± 0.10	0.25± 0.10	(0.50)	0.30± 0.10
RTA03-4D (0603)	3.20± 0.20	1.60± 0.15	0.50± 0.10	0.30± 0.15	0.30± 0.15	(0.80)	0.50± 0.10
RTA03-4C (0603)	3.20± 0.15	1.60± 0.15	0.55± 0.10	0.35± 0.15	0.45± 0.15	(0.80)	0.50± 0.10
RTA02-8D (0402)	4.00± 0.20	1.60± 0.10	0.40± 0.10	0.30± 0.15	0.30± 0.10	(0.50)	0.25± 0.10
RTA03-8C (0603)	6.40± 0.20	1.60± 0.20	0.55± 0.10	0.30± 0.15	0.40± 0.15	(0.80)	0.50± 0.10
RTA03-2C (0603)	1.60± 0.15	1.60± 0.15	0.55± 0.10	0.30± 0.15	0.40± 0.15	(0.80)	0.50± 0.10
RTA02-2C (0402)	1.00± 0.10	1.00± 0.10	0.30± 0.10	0.18± 0.10	0.25± 0.10	(0.50)	0.30± 0.10

Unit:mm

Remark

IT' S NOT UNDER CONTROL FOR PDF FILE
PLS NOTE THE VERSION STATED.

Issue Dep. DATA Center.

Do not copy without permission

Series No. **60**

Thick Film Chip Resistors Array Product Specification

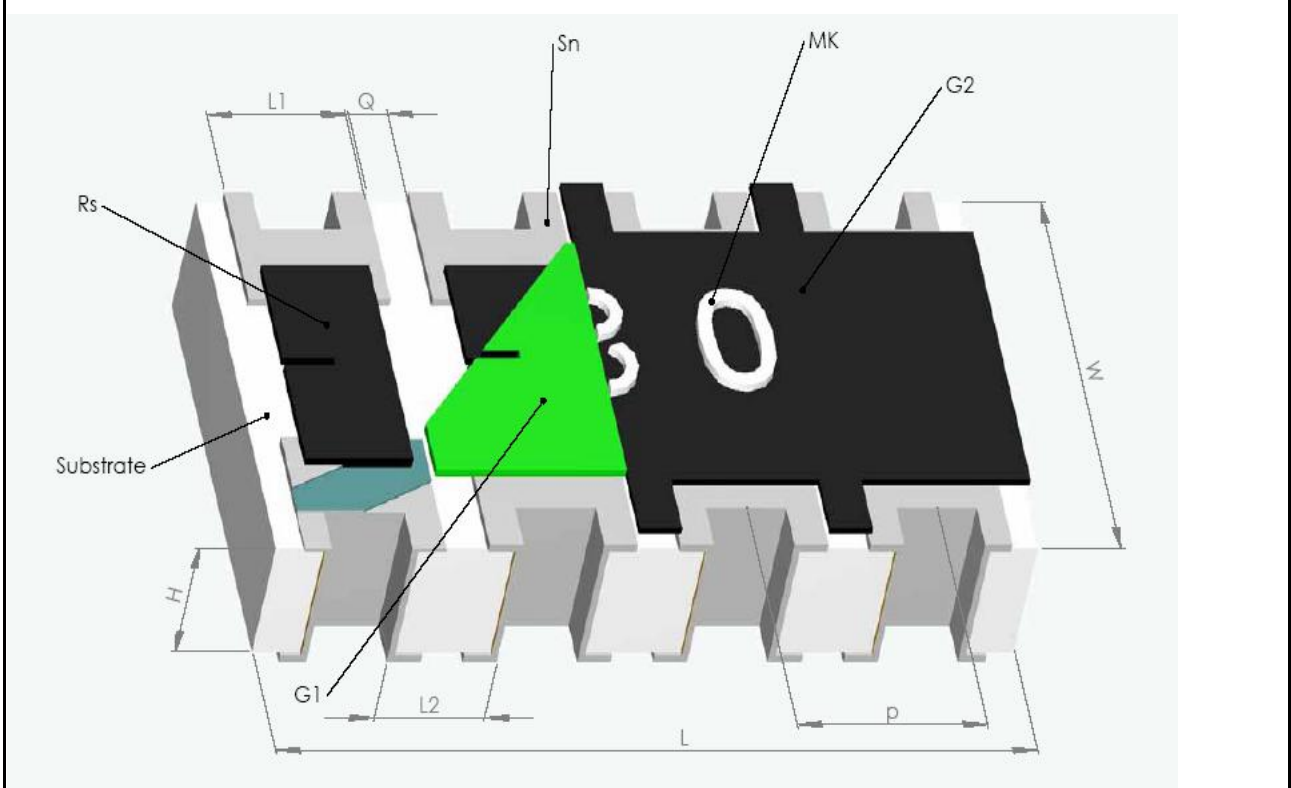
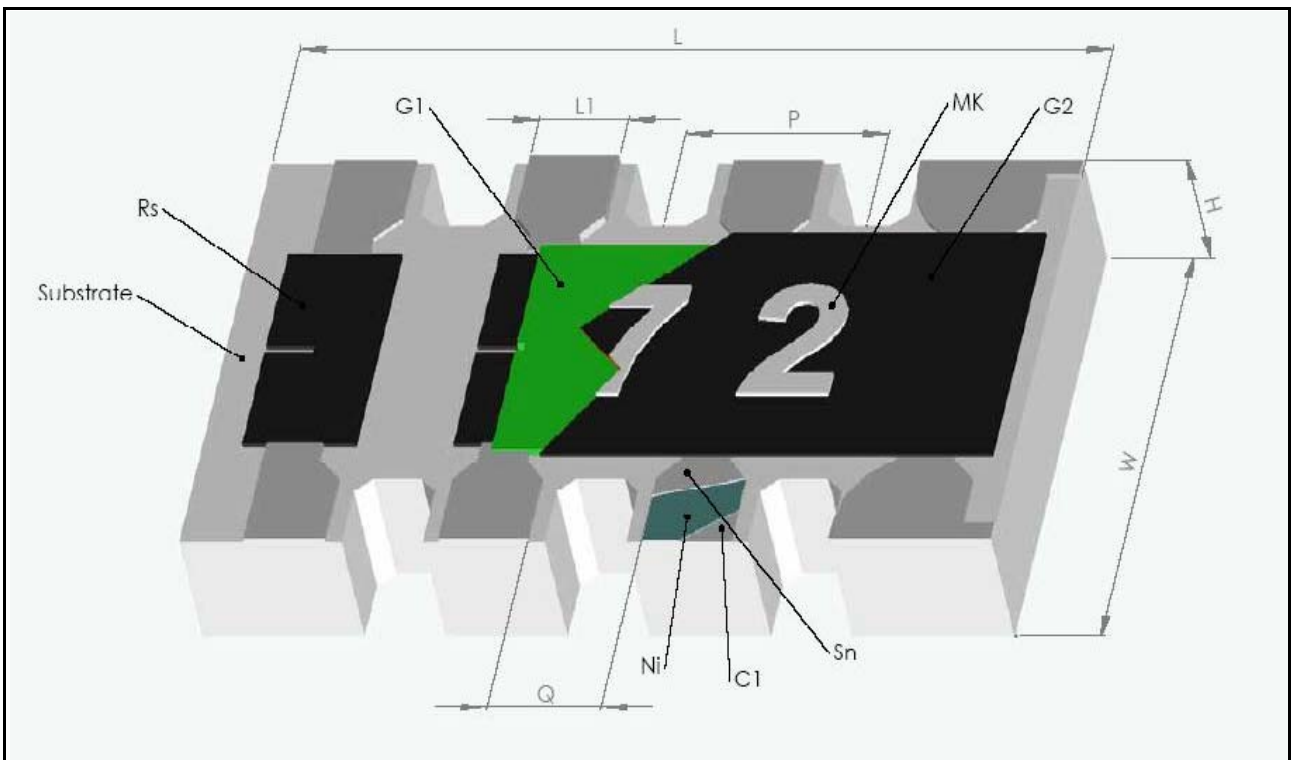

Remark

IT'S NOT UNDER CONTROL FOR PDF FILE
PLS NOTE THE VERSION STATED.

Issue Dep. DATA Center.

Do not copy without permission

Series No. **60**

Thick Film Chip Resistors Array Product Specification

5 Reliability Test:

5.1 Electrical Performance Test

ITEM	Conditions	Specifications	
		Resistors	Jumper
Temperature Coefficient of Resistance	$TCR \text{ (ppm/}^\circ\text{C)} = \frac{(R2 - R1)}{R1 (T2 - T1)} \times 10^6$ R1: Resistance at room temperature R2: Resistance at -55°C or +125°C T1: Room temperature T2: Temperature -55°C or +125°C Refer to JIS-C5201-1 4.8	Refer item 3. General Specifications	NA
Short Time Overload	Applied 2.5 times rated voltage for 5 seconds and release the load for about 30 minutes, then measure its resistance variance rate. (Rated voltage refer to item 3. general specifications) Refer to JIS-C5201-1 4.13	0.5%、1%:± (1.0%+0.05Ω) 2%、5% :± (2.0%+0.10Ω)	50mΩ Lower
		No evidence of mechanical damage,	
Insulation Resistance	Put the resistor in the fixture, add 100 VDC in +, - terminal for 60 sec then measured the insulation resistance between electrodes and insulating enclosure or between electrodes and base material. Refer to JIS-C5201-1 4.6	≥ 10 ⁹ Ω	
Dielectric Withstand Voltage	Put the resistor in the fixture, add 300 VAC in +, - terminal for 60 sec. Refer to JIS-C5201-1 4.7	No short or burned on the appearance.	
Intermittent Overload	Put the tested resistor in chamber under temperature 25± 2°C and load 2.5 times rated DC voltage for 1 sec on, 25 sec off, 10000 ⁺⁴⁰⁰ ₀ test cycles, then it be left at no-load for 1 hour, then measure its resistance variance rate. Refer to JIS-C5201-1 4.13	± (5.0% + 0.10Ω)	50mΩ Lower
Noise Level	Refer to JIS-C5201-1 4.12	Resistance	Noise
		R < 100Ω	≤ -10db(0.32 uV/V)
		100Ω ≤ R < 1KΩ	≤ 0db(1.0 uV/V)
		1KΩ ≤ R < 10KΩ	≤ 10db(3.2 uV/V)
		10KΩ ≤ R < 100KΩ	≤ 15db(5.6 uV/V)
		100KΩ ≤ R < 1MΩ	≤ 20db(10 uV/V)
		1MΩ ≤ R	≤ 30db(32 uV/V)
NA			

Remark

IT'S NOT UNDER CONTROL FOR PDF FILE
PLS NOTE THE VERSION STATED.

Issue Dep. **DATA Center.**

Do not copy without permission

Series No. **60**

Thick Film Chip Resistors Array Product Specification

5.2 Mechanical Performance Test

ITEM	Conditions	Specifications																																		
		Resistors	Jumper																																	
Resistance to solvent	The tested resistor be immersed into isopropyl alcohol of 20~25°C for 5 minutes, then the resistor is left in the room for 48 hr , then measure its resistance variance rate. Refer to JIS-C5201-1 4.29	01-2D:± (1.0%+0.05Ω) Other:± (0.5%+0.05Ω)	50mΩ Lower																																	
Resistance to soldering heat	<p>◎Test method 1 (Reflow test): The tested resistor should be subject in the following procedure, and after finish each step, it should be left for a duration of 2 hours or longer at a temperature of 30°C or lower and a humidity of 70% RH or lower.</p> <table border="1" style="width: 100%; border-collapse: collapse;"> <thead> <tr> <th>Step</th> <th>Procedure</th> <th>Environmental test condition</th> </tr> </thead> <tbody> <tr> <td>1</td> <td>Resistance measuring</td> <td>Room temperature</td> </tr> <tr> <td>2</td> <td>Baking</td> <td>125°C · 24 hours</td> </tr> <tr> <td>3</td> <td>Humidification</td> <td>85°C · 85% · 168 hours</td> </tr> <tr> <td>4</td> <td>Reflow (1)</td> <td>Reflow temperature curve and component surface temperature Table 1</td> </tr> <tr> <td>5</td> <td>Humidification</td> <td>85°C · 65% · 24 hours</td> </tr> <tr> <td>6</td> <td>Reflow (2)</td> <td>Reflow temperature curve and component surface temperature Table 2</td> </tr> <tr> <td>7</td> <td>Resistance measuring</td> <td>Room temperature</td> </tr> </tbody> </table> <p>◎Reflow temperature curve</p> <p>◎Component surface temperature</p> <table border="1" style="width: 100%; border-collapse: collapse;"> <thead> <tr> <th colspan="3">Table 1 Description example in specification document(1)</th> </tr> <tr> <th>Temperature-retaining time:230°C or higher</th> <th>Peak temperature</th> <th>Temperature measured at the component body surface during preheating</th> </tr> </thead> <tbody> <tr> <td>30 seconds</td> <td>240°C</td> <td>150 to 160 °C</td> </tr> </tbody> </table>	Step	Procedure	Environmental test condition	1	Resistance measuring	Room temperature	2	Baking	125°C · 24 hours	3	Humidification	85°C · 85% · 168 hours	4	Reflow (1)	Reflow temperature curve and component surface temperature Table 1	5	Humidification	85°C · 65% · 24 hours	6	Reflow (2)	Reflow temperature curve and component surface temperature Table 2	7	Resistance measuring	Room temperature	Table 1 Description example in specification document(1)			Temperature-retaining time:230°C or higher	Peak temperature	Temperature measured at the component body surface during preheating	30 seconds	240°C	150 to 160 °C	± (1.0%+0.05Ω)	50mΩ Lower
Step	Procedure	Environmental test condition																																		
1	Resistance measuring	Room temperature																																		
2	Baking	125°C · 24 hours																																		
3	Humidification	85°C · 85% · 168 hours																																		
4	Reflow (1)	Reflow temperature curve and component surface temperature Table 1																																		
5	Humidification	85°C · 65% · 24 hours																																		
6	Reflow (2)	Reflow temperature curve and component surface temperature Table 2																																		
7	Resistance measuring	Room temperature																																		
Table 1 Description example in specification document(1)																																				
Temperature-retaining time:230°C or higher	Peak temperature	Temperature measured at the component body surface during preheating																																		
30 seconds	240°C	150 to 160 °C																																		
		No evidence of electrode damage. No side conductive peel off.																																		

Remark

IT' S NOT UNDER CONTROL FOR PDF FILE
PLS NOTE THE VERSION STATED.

Issue Dep. DATA Center.

Do not copy without permission

Series No. **60**

Thick Film Chip Resistors Array Product Specification

ITEM	Conditions	Specifications																																					
		Resistors	Jumper																																				
	<p style="text-align: center;">Table 2 Description example in specification document(2)</p> <table border="1" style="width: 100%; border-collapse: collapse;"> <tr> <th style="width: 20%;">Temperature</th> <th style="width: 20%;">Temperature-retaining time</th> <th style="width: 60%;">Temperature measured at the component body surface during preheating</th> </tr> <tr> <td>220°C or higher</td> <td>90 seconds</td> <td rowspan="4" style="text-align: center; vertical-align: middle;">150 to 160°C</td> </tr> <tr> <td>230°C or higher</td> <td>60 seconds</td> </tr> <tr> <td>240°C or higher</td> <td>5 seconds</td> </tr> <tr> <td>Peak</td> <td>245°C</td> </tr> </table> <p>◎Test method 2 (sloder pot test): The tested resistor should be subject in the following procedure, and after finish each step, it should be left for a duration of 2 hours or lower at a temperature of 30°C or lower and a humidity of 70% RH or lower.</p> <table border="1" style="width: 100%; border-collapse: collapse;"> <thead> <tr> <th style="width: 10%;">Step</th> <th style="width: 20%;">Procedure</th> <th style="width: 70%;">Environmental test condition</th> </tr> </thead> <tbody> <tr> <td style="text-align: center;">1</td> <td style="text-align: center;">Resistance measuring</td> <td style="text-align: center;">Room temperature</td> </tr> <tr> <td style="text-align: center;">2</td> <td style="text-align: center;">Baking</td> <td style="text-align: center;">125°C , 24 hours</td> </tr> <tr> <td style="text-align: center;">3</td> <td style="text-align: center;">Humidification</td> <td style="text-align: center;">85°C , 85% , 168 hours</td> </tr> <tr> <td style="text-align: center;">4</td> <td style="text-align: center;">Sloder pot test</td> <td style="text-align: center;">260± 3°C , 10 sec</td> </tr> <tr> <td style="text-align: center;">5</td> <td style="text-align: center;">Placed</td> <td style="text-align: center;">85°C , 65% , 24 hours</td> </tr> <tr> <td style="text-align: center;">6</td> <td style="text-align: center;">Sloder pot test</td> <td style="text-align: center;">260± 3°C , 10 sec</td> </tr> <tr> <td style="text-align: center;">7</td> <td style="text-align: center;">Resistance measuring</td> <td style="text-align: center;">Room temperature</td> </tr> </tbody> </table> <p>By Sony (SS-00254-5) Refer to JIS-C5201-1 4.18</p>	Temperature	Temperature-retaining time	Temperature measured at the component body surface during preheating	220°C or higher	90 seconds	150 to 160°C	230°C or higher	60 seconds	240°C or higher	5 seconds	Peak	245°C	Step	Procedure	Environmental test condition	1	Resistance measuring	Room temperature	2	Baking	125°C , 24 hours	3	Humidification	85°C , 85% , 168 hours	4	Sloder pot test	260± 3°C , 10 sec	5	Placed	85°C , 65% , 24 hours	6	Sloder pot test	260± 3°C , 10 sec	7	Resistance measuring	Room temperature		
Temperature	Temperature-retaining time	Temperature measured at the component body surface during preheating																																					
220°C or higher	90 seconds	150 to 160°C																																					
230°C or higher	60 seconds																																						
240°C or higher	5 seconds																																						
Peak	245°C																																						
Step	Procedure	Environmental test condition																																					
1	Resistance measuring	Room temperature																																					
2	Baking	125°C , 24 hours																																					
3	Humidification	85°C , 85% , 168 hours																																					
4	Sloder pot test	260± 3°C , 10 sec																																					
5	Placed	85°C , 65% , 24 hours																																					
6	Sloder pot test	260± 3°C , 10 sec																																					
7	Resistance measuring	Room temperature																																					
Solderability	<p>Preconditioning: Put the tested resistor in the apparatus of PCT, at a temperature of 105°C, humidity of 100% RH, and pressure of 1.22× 10⁵ Pa for a duration of 4 hours. Then after left the tested resistor in room temperature for 2 hours or more.</p> <p>Test method: ◎Test item 1 (solder pot test): The resistor be immersed into solder pot in temperature 235± 5°C for 2 sec, then the resistor is left as placed under microscope to observed its solder area. By SONY (SS-00254-2) Refer to JIS-C5201-1 4.17</p>	1.Test item 1: Solder coverage over 95%																																					

Remark

IT' S NOT UNDER CONTROL FOR PDF FILE
PLS NOTE THE VERSION STATED.

Do not copy without permission

Issue Dep. **DATA Center.**

Series No. **60**

Thick Film Chip Resistors Array Product Specification

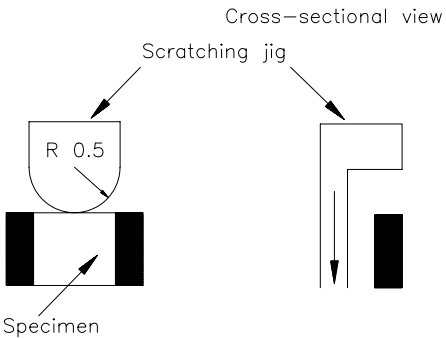
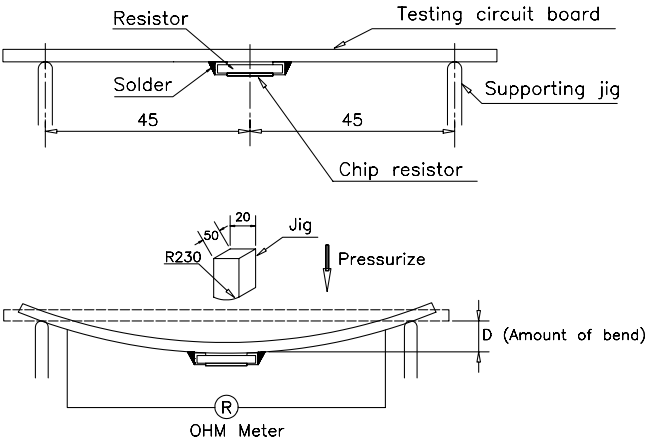
ITEM	Conditions	Specifications	
		Resistors	Jumper
Joint strength of solder	<p>Preconditioning: Put the tested resistor in the apparatus of PCT, at a temperature of 105°C, humidity of 100% RH, and pressure of 1.22× 10⁵ Pa for a duration of 4 hours. Then after left the tested resistor in room temperature for 2 hours or more.</p> <p>Test method: ◎Test item 1 (Adhesion): A static load using a R0.5 scratch tool shall be applied on the core of the component and in the direction of the arrow and held for 10 seconds and under load measure its resistance variance rate. 1.02-2C=10N load 2.Other=20N load 3.01-2D=5N load</p> <div style="text-align: center;">  <p>Cross-sectional view Scratching jig R 0.5 Specimen</p> </div> <p>Refer to JIS-C5201-1 4.32 ◎Test item 2 (Bending Strength): Solder tested resistor on the PC board, add force in the middle down, and under load measure its resistance variance rate . D=(1)01-2D=3mm (2)Other=5mm</p> <div style="text-align: center;">  <p>Resistor Testing circuit board Solder 45 45 Supporting jig Chip resistor 150 20 Jig Pressurize D (Amount of bend) OHM Meter</p> </div> <p>Refer to JIS-C5201-1 4.33</p>	<p>Test item1: 1.ΔR%=± (1.0%+0.05Ω) 2.No evidence of mechanical damage. No terminal peel off.</p> <p>Test item2: 1.ΔR%=± (1.0%+0.05Ω) 2.No evidence of mechanical damage. No terminal peel off and core body cracked.</p> <p>Test item3: (1).Adhesion After application of temperature cycle, adhesion should be 50% or more of initial strength. (2).Bending Strength: After application of temperature cycle, bending load should be 50% or more of initial strength.</p>	50mΩ Lower

Remark

IT'S NOT UNDER CONTROL FOR PDF FILE
PLS NOTE THE VERSION STATED.

Do not copy without permission

Issue Dep. DATA Center.

Series No. **60**

RALEC
旺詮

Thick Film Chip Resistors Array Product Specification

Document No.	IE-SP-011
Released Date	2011/02/20
Page No.	11/21

ITEM	Conditions	Specifications									
		Resistors	Jumper								
	◎Test item 3 (Endurance measurement): Put the tested resistor in the chamber under the temperature cycle which shown in table 1 shall be repeated 1000 ± 4 times consecutively. Then separate follow test item 1 and test item 2 50% condition to test, measured its resistance variance rate. <table border="1" style="margin-left: 20px;"> <caption>Table 1 Temperature cycle test condition</caption> <thead> <tr> <th></th> <th>Testing condition</th> </tr> </thead> <tbody> <tr> <td>Lowest temperature</td> <td>$-35 \pm 5^{\circ}\text{C}$</td> </tr> <tr> <td>Highest temperature</td> <td>$105 \pm 5^{\circ}\text{C}$</td> </tr> <tr> <td>Temperature-retaining time</td> <td>15 minutes each</td> </tr> </tbody> </table> By SONY (SS-00254-9)		Testing condition	Lowest temperature	$-35 \pm 5^{\circ}\text{C}$	Highest temperature	$105 \pm 5^{\circ}\text{C}$	Temperature-retaining time	15 minutes each		
	Testing condition										
Lowest temperature	$-35 \pm 5^{\circ}\text{C}$										
Highest temperature	$105 \pm 5^{\circ}\text{C}$										
Temperature-retaining time	15 minutes each										
Leaching Test	The tested resistor be immersed into molten solder of $260 \pm 5^{\circ}\text{C}$ for 30 seconds. Then the resistor is left as placed under microscope to observed its solder area. By SONY (SS-00254-9)	1.Solder coverage over 95%. 2.The underlying material (such as ceramic) shall not be visible at the crest corner area of the electrode.									

Remark

IT' S NOT UNDER CONTROL FOR PDF FILE
PLS NOTE THE VERSION STATED.

Issue Dep. **DATA Center.**

Do not copy without permission

Series No. **60**

RALEC 旺詮	Thick Film Chip Resistors Array Product Specification	Document No.	IE-SP-011
		Released Date	2011/02/20
		Page No.	12/21

5.3 Environmental Test

ITEM	Conditions	Specifications															
		Resistors	Jumper														
Resistance to Dry Heat	Put tested resistors in chamber under temperature $155 \pm 5^\circ\text{C}$ for $1,000 \pm 4$ hours. Then leaving in room temperature for 60 minutes, and measure its resistance variance rate. Refer to JIS-C5201-1 4.25	$0.5\% \cdot 1\% \pm (1.0\% + 0.05\Omega)$ $2\% \cdot 5\% \pm (2.0\% + 0.10\Omega)$	$50\text{m}\Omega$ Lower														
Thermal Shock	Put the tested resistor in the thermal shock chamber under the temperature cycle which shown in the following table shall be repeated 300 times consecutively. Then leaving the tested resistor in the room temperature for 1 hours, and measure its resistance variance rate. <table border="1" style="margin-left: 20px;"> <thead> <tr> <th></th> <th>Testing Condition</th> </tr> </thead> <tbody> <tr> <td>Lowest Temperature</td> <td>$-55 \pm 5^\circ\text{C}$</td> </tr> <tr> <td>Highest Temperature</td> <td>$125 \pm 5^\circ\text{C}$</td> </tr> <tr> <td>Temperature-retaining time</td> <td>15 minutes each</td> </tr> </tbody> </table> Refer to MIL-STD 202 Method 107		Testing Condition	Lowest Temperature	$-55 \pm 5^\circ\text{C}$	Highest Temperature	$125 \pm 5^\circ\text{C}$	Temperature-retaining time	15 minutes each	$\pm (1.0\% + 0.05\Omega)$	$50\text{m}\Omega$ Lower						
			Testing Condition														
Lowest Temperature	$-55 \pm 5^\circ\text{C}$																
Highest Temperature	$125 \pm 5^\circ\text{C}$																
Temperature-retaining time	15 minutes each																
		No evidence of mechanical damage,															
Loading Life in Moisture	Put the tested resistor in the chamber under temperature $40 \pm 2^\circ\text{C}$, relative humidity 90~95% and load the rated voltage for 90 minutes on, 30 minutes off, total 1000 hours. Then leaving the tested resistor in room temperature for 60 minutes, and measure its resistance variance rate. Refer to JIS-C5201-1 4.24	$0.5\% \cdot 1\% \pm (2.0\% + 0.10\Omega)$ $2\% \cdot 5\% \pm (3.0\% + 0.10\Omega)$	$50\text{m}\Omega$ Lower														
		No evidence of mechanical damage.															
Load Life	Put the tested resistor in chamber under temperature $70 \pm 2^\circ\text{C}$ and load the rated voltage for 90 minutes on, 30 minutes off, total 1000 hours. Then leaving the tested resistor in room temperature for 60 minutes, and measure its resistance variance rate. Refer to JIS-C5201-1 4.25	$0.5\% \cdot 1\% \pm (2.0\% + 0.10\Omega)$ $2\% \cdot 5\% \pm (3.0\% + 0.10\Omega)$	$50\text{m}\Omega$ Lower														
		No evidence of mechanical damage, no short or burned on the appearance.															
Low Temperature Operation	Put the tested resistor in the chamber at room temperature 25°C . Decreasing the temperature to -55°C and keep the temperature at -55°C for 1 hour. Then load the rated voltage for 45 minutes on, and 15 minutes off. Then leaving the tested resistor in room temperature for 8 ± 1 hours, and measure its resistance variance rate. Refer to MIL-R-55342D 4.7.4	$0.5\% \cdot 1\% \pm (0.5\% + 0.05\Omega)$ $2\% \cdot 5\% \pm (1.0\% + 0.05\Omega)$	$50\text{m}\Omega$ Lower														
		No evidence of mechanical damage,															
Whisker Test	◎Test item 1 (Thermal Shock test): <table border="1" style="margin-left: 20px;"> <tbody> <tr> <td>Minimum storage temperature</td> <td>$-40 \pm 2^\circ\text{C}$</td> </tr> <tr> <td>Maximum storage temperature</td> <td>$85 \pm 2^\circ\text{C}$</td> </tr> <tr> <td>Temperature-retaining time</td> <td>7 min.</td> </tr> <tr> <td>Number of temperature cycles</td> <td>1,500</td> </tr> </tbody> </table> ◎Test item 2 (Constant temperature/humidity test): <table border="1" style="margin-left: 20px;"> <tbody> <tr> <td>Temperature</td> <td>85°C</td> </tr> <tr> <td>Humidity</td> <td>85%</td> </tr> <tr> <td>Testing duration</td> <td>500 ± 4 hours</td> </tr> </tbody> </table>	Minimum storage temperature	$-40 \pm 2^\circ\text{C}$	Maximum storage temperature	$85 \pm 2^\circ\text{C}$	Temperature-retaining time	7 min.	Number of temperature cycles	1,500	Temperature	85°C	Humidity	85%	Testing duration	500 ± 4 hours	Max. $50 \mu\text{m}$	
Minimum storage temperature	$-40 \pm 2^\circ\text{C}$																
Maximum storage temperature	$85 \pm 2^\circ\text{C}$																
Temperature-retaining time	7 min.																
Number of temperature cycles	1,500																
Temperature	85°C																
Humidity	85%																
Testing duration	500 ± 4 hours																

Remark	IT' S NOT UNDER CONTROL FOR PDF FILE PLS NOTE THE VERSION STATED.	Issue Dep. DATA Center.
	Do not copy without permission	Series No. 60

Thick Film Chip Resistors Array Product Specification

ITEM	Conditions	Specifications	
		Resistors	Jumper
	◎Inspection: Inspect for whisker formation on specimens that underwent the acceleration test specified in subclause 4.2, with a magnifier (stereomicroscope) of about 40 or higher magnification. If judgment is hard in this method, use a scanning electron microscope (SEM) of about 1,000 or higher magnification. By SONY (SS-00254-8)		

6 Recommend Soldering Method

6.1 Lead Free Reflow Soldering Profile

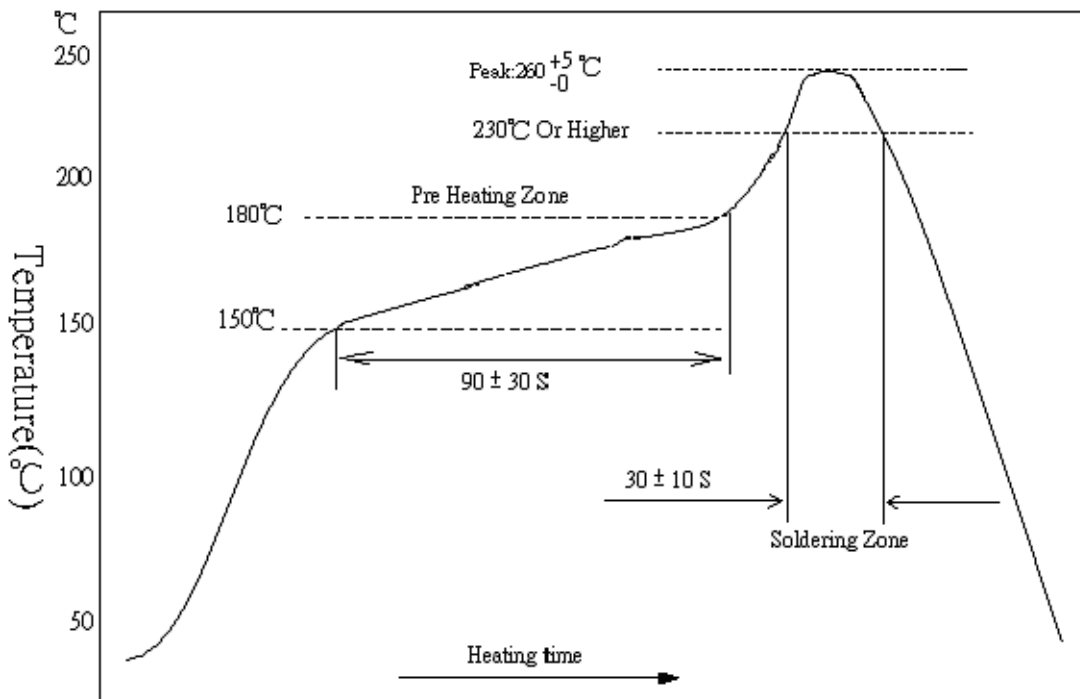

6.2 Soldering Iron: temperature $350\text{ }^{\circ}\text{C} \pm 10\text{ }^{\circ}\text{C}$, dwell time shall be less than 3 sec.

7 Recommend Land Pattern Design (For Reflow Soldering):

Unit : mm

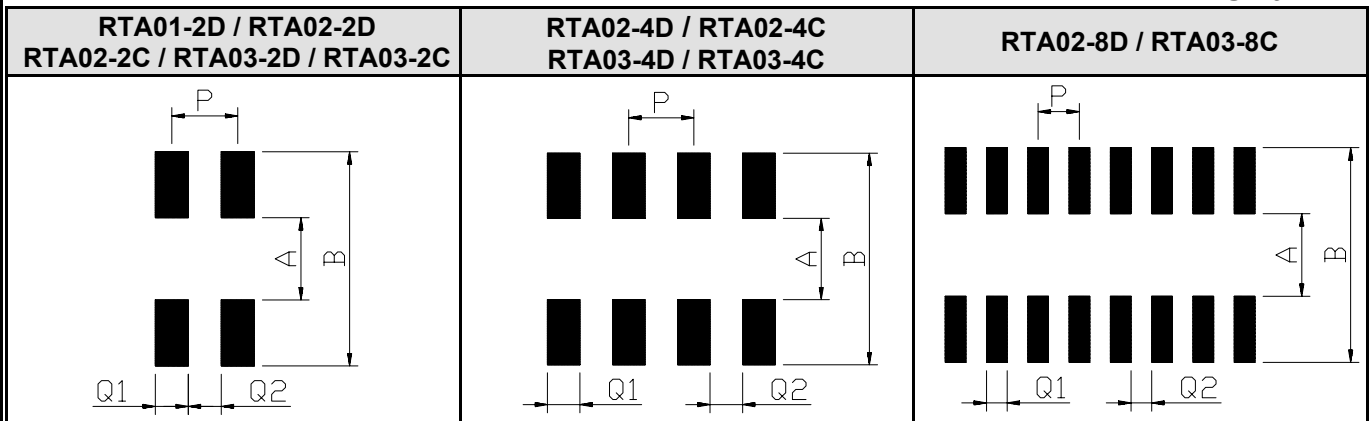

TYPE \ DIM	A	B	P	Q1	Q2
RTA01-2D	0.30	0.90	0.50	0.30	0.30
RTA02-2D	0.50	2.00	0.67	0.33	0.34
RTA03-2D	1.00	2.60	0.80	0.40	0.40
RTA02-4D RTA02-4C	0.50	2.00	0.50	0.28	0.22
RTA03-4D RTA03-4C RTA03-2C	1.00	2.60	0.80	0.40	0.40
RTA02-8D	1.00	2.60	0.50	0.25	0.25
RTA03-8C	1.00	2.60	0.80	0.40	0.40
RTA02-2C	0.50	2.00	0.50	0.28	0.22

8 Marking Diagrams:

8.1 $\pm 2\%$ 、 $\pm 5\%$ Tolerance:

8.1.1 Resistance Range $\geq 10 \Omega$: 3 digits in E-24 series, first two digits are significant figures, third digit is multiplier (10^x).

《EX》 Marking → 100

$$100 = 10 \times 10^0 = 10 \Omega$$

8.1.2 Resistance Range $< 10 \Omega$: 3 digits in E-24 series, first and third digits are significant figures, second digit is multiplier (10^{-1}).

《EX》 Marking → 4R7

$$4R7 = 47 \times 10^{-1} = 4.7 \Omega$$

Remark

IT'S NOT UNDER CONTROL FOR PDF FILE
PLS NOTE THE VERSION STATED.

Issue Dep. DATA Center.

Do not copy without permission

Series No. **60**

Thick Film Chip Resistors Array Product Specification

8.2 ± 0.5%、1% Tolerance:

8.2.1 Resistance Range $\geq 100 \Omega$: 4 digits in E-24 series or E-96 series, first three digits are significant figures, forth digit is multiplier (10^x).











《EX》 Marking→1002
 $1002 = 100 \times 10^2 = 10000 \Omega = 10K \Omega$

8.2.2 Resistance Range $< 100 \Omega$: 4 digits in E-24 series or E-96 series, three digits are significant figures, R digit is multiplier (10^x).

《EX》 Marking→10R2 ,R digit is multiplier (10^{-1}).
 $10R2 = 102 \times 10^{-1} = 10.2 \Omega$
 Marking→1R02 ,R digit is multiplier (10^{-2}).
 $1R02 = 102 \times 10^{-2} = 1.02 \Omega$

8.3 RTA01-2D、RTA02-2D、RTA02-2C、RTA02-4C No Marking

8.4 Marking Standard

	Standard	1	2	3	4	5	6	7	8	9	0	R
TYPE	Marking											
RTA03-2D												
RTA02-4D												
RTA03-2C												
RTA03-4D												
RTA03-4C												
RTA02-8D												
RTA03-8C												

Remark

IT' S NOT UNDER CONTROL FOR PDF FILE
PLS NOTE THE VERSION STATED.

Issue Dep. DATA Center.

Do not copy without permission

Series No. **60**

Thick Film Chip Resistors Array
Product Specification

8.5 Marking

8.5.1 E-24 series

10	11	12	13	15	16	18	20	22	24	27	30
33	36	39	43	47	51	56	62	68	75	82	91

8.5.2 E-96 series

100	102	105	107	110	113	115	118	121	124	127	130
133	137	140	143	147	150	154	158	162	165	169	174
178	182	187	191	196	200	205	210	215	221	226	232
237	243	249	255	261	267	274	280	287	294	301	309
316	324	332	340	348	357	365	374	383	392	402	412
422	432	442	453	464	475	487	499	511	523	536	549
562	576	590	604	619	634	649	665	681	698	715	732
750	768	787	806	825	845	866	887	909	931	953	976

9 Plating Thickness:

9.1 Ni: $\geq 1 \mu m$

9.2 Sn(Tin): $\geq 3 \mu m$

9.3 Sn(Tin): Matte Sn

Remark

IT' S NOT UNDER CONTROL FOR PDF FILE
PLS NOTE THE VERSION STATED.

Issue Dep. DATA Center.

Do not copy without permission

Series No. **60**

Thick Film Chip Resistors Array Product Specification

10.3 Cover Tape Peel off Strength Specifications: 0.07~0.7N (7.1~71.4gf)

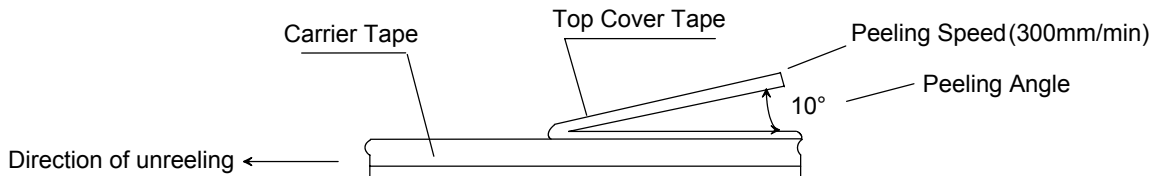

10.4 Packaging Qty:

Type	Tape Width	Packaging (pcs/reel)							
		TH				TP			
		2 mm Pitch				4 mm Pitch			
		TH	H2	H3	H4	TP	P2	P2	P4
RTA01-2D	8 mm								
RTA02-2D、RTA02-2C	8 mm	10,000	20,000	30,000	40,000	--	--	--	--
RTA02-4C、RTA02-4D	8 mm								
RTA03-2D、RTA03-2C	8 mm								
RTA03-4C、RTA03-4D	8 mm	--	--	--	--	5,000	10,000	15,000	20,000
RTA02-8D、RTA03-8C	12 mm								
Reel Type		7"	10"	13"	13"	7"	10"	13"	13"

10.4.1 Typical taping type: TH、TP

10.4.2 Other taping type are upon customer's request.

10.5 Reel Dimensions:

Unit:mm

Reel Type / Tape	Wa	M	A	B	C	D
7" reel for 8 mm tape	9.0 ± 0.5	178 ± 2.0				60.0 ± 1.0
7" reel for 12 mm tape	13.8 ± 0.5	178 ± 2.0	2.0 ± 0.5	13.5 ± 0.5	21.0 ± 0.5	80.0 ± 1.0
10" reel for 8 mm tape	10.0 ± 0.5	254 ± 2.0				100.0 ± 1.0
13" reel for 8 mm tape	10.0 ± 0.5	330 ± 2.0				100.0 ± 1.0

Remark

IT'S NOT UNDER CONTROL FOR PDF FILE
PLS NOTE THE VERSION STATED.

Issue Dep. DATA Center.

Do not copy without permission

Series No. **60**

Thick Film Chip Resistors Array Product Specification

10.6 Label:

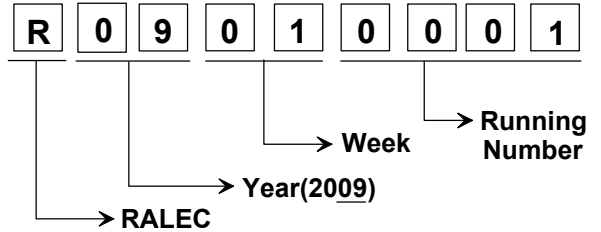
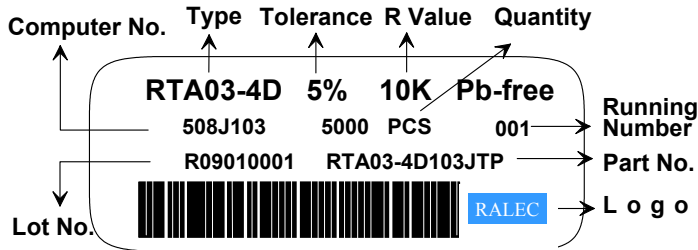

10.7 Inner Box

Reel Number	D Dimension (mm)
1	12
2	24
3	36
4	48
5	60
6	72
7	84
8	96
9	108
10	120

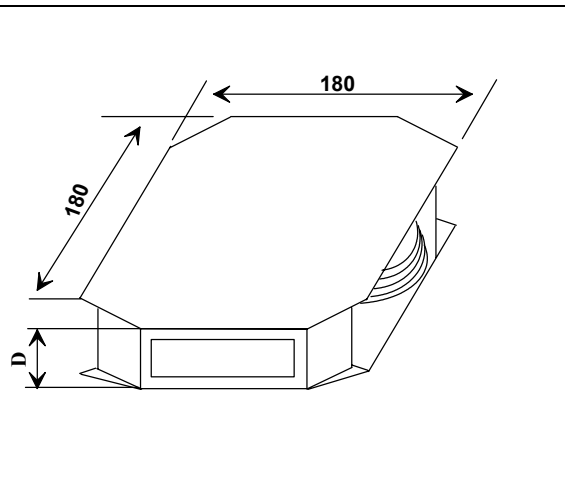

10.8 Box

10R Inner Box Number	L(mm)	W(mm)	D(mm)
2	272	205	210
4	375	280	210
8	544	380	210

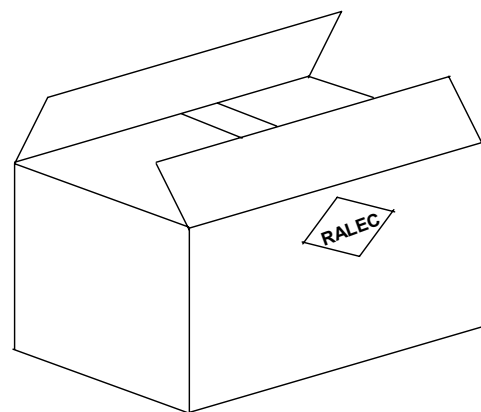

Remark

IT' S NOT UNDER CONTROL FOR PDF FILE
PLS NOTE THE VERSION STATED.

Issue Dep. DATA Center.

Do not copy without permission

Series No. **60**

Thick Film Chip Resistors Array Product Specification

10.9 Box (For China)

10R Inner Box Number	L(mm)	W(mm)	D(mm)
2	272	205	210
4	375	280	210
8	544	380	210

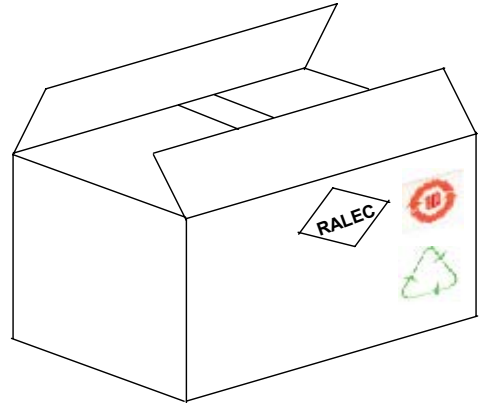

11 Stock period

11.1 The temperature condition must be controlled at $25 \pm 5 \text{ }^\circ\text{C}$, the R.H. must be controlled at $60 \pm 15\%$. The stock can maintain quality level in two years.

12 The carton packaged for electronic-information products is made by the symbol as follows: (For china)

<i>Marking for control of pollution cause by electronic-information products</i>	<i>Marking for package recovery</i>

Remark

IT' S NOT UNDER CONTROL FOR PDF FILE
PLS NOTE THE VERSION STATED.

Do not copy without permission

Issue Dep. DATA Center.

Series No. **60**

RALEC 旺詮	Thick Film Chip Resistors Array Product Specification	Document No.	IE-SP-011
		Released Date	2011/02/20
		Page No.	21/21

13 For this part. It does not use the materials that include the substances specified in RoHS , the detail refer to the part of prohibition or exclusion items in RoHS (2002/95/EC).

1. Cadmium and cadmium compounds (*permissive content <100 ppm*)
2. Lead and lead compounds (*permissive content <1000 ppm*)
 Exceptions specified:
 - (1). Lead contained in the glass of cathode ray tubes, electronic components and fluorescent tubes.
 - (2). The glass material used in the electronic components, which includes resistor elements, conductive pastes (silver or copper ones), adhesives, glass frit and sealing materials.
3. Mercury and its mercury compounds (*permissive content <100 ppm*)
4. Hexavalent chromium compounds (*permissive content <100 ppm*)
5. Polybrominated biphenyls(PBB) (*permissive content <100 ppm*)
6. Polybrominated diphenylethers(PBDE) (*permissive content <100 ppm*)

14 Attachments

14.1 Document Revise Record Paper

Remark	IT' S NOT UNDER CONTROL FOR PDF FILE PLS NOTE THE VERSION STATED.	Issue Dep. DATA Center.
	Do not copy without permission	Series No. 60

X-ON Electronics

Largest Supplier of Electrical and Electronic Components

Click to view similar products for [Resistor Networks & Arrays](#) category:

Click to view products by [RALEC](#) manufacturer:

Other Similar products are found below :

[CS6600552K000B8768](#) [CSC08A01470KGEK](#) [M8340105K1002FGD03](#) [M8340106MA010FHD03](#) [M8340107K1471FGD03](#)
[M8340108K1001FCD03](#) [M8340108K2402GGD03](#) [M8340108K3242FGD03](#) [M8340108K3322FCD03](#) [M8340108K6192FGD03](#)
[M8340108K6202GGD03](#) [M8340109K2002FCD03](#) [M8340109M4701GCD03](#) [EXB-24N121JX](#) [EXB-24N470JX](#) [EXB-A10E102J](#) [EXB-](#)
[A10E104J](#) [744C083101JTR](#) [EXB-U18240JX](#) [MDP1603100KGE04](#) [PRA100I2-1KBWNW](#) [GUS-SS4-BLF-01-1002-G](#)
[ACAS06S0830339P100](#) [ACAS06S0830343P100](#) [ACAS06S0830344P100](#) [RM2012A-102/104-PBVW10](#) [RM2012A-102503-PBVW10](#)
[RM2012A-502104-PBVW10](#) [RM3216B-102302-PBVW10](#) [L091S102LF](#) [ACAS06S0830341P100](#) [ACAS06S0830342P100](#)
[ACAS06S0830345P100](#) [EXB-14V300JX](#) [EXB-U18330JX](#) [EXB-V8V220GV](#) [PRA100I2-10KBWN](#) [PRA100I4-10KBWN](#)
[M8340102M4701JAD04](#) [M8340105K1002GGD03](#) [M8340105M1001JCD03](#) [M8340107K3402FCD03](#) [M8340108K1000FGD03](#)
[M8340108K1000GGD03](#) [M8340108K1002GGD03](#) [M8340108K2001FCD03](#) [M8340108K2002FCD03](#) [M8340108K3901GGD03](#)
[M8340108K4122FGD03](#) [M8340108K4992FGD03](#)