

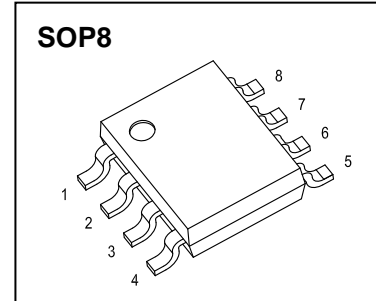

SOP8 Plastic-Encapsulate MOSFETS

CJQ4435 P-Channel Power MOSFET

$V_{(BR)DSS}$	$R_{DS(on)MAX}$	I_D
-30V	24mΩ@ -10V	-9.1A
	35mΩ@ -4.5V	



DESCRIPTION

The CJQ4435 uses advanced trench technology to provide excellent $R_{DS(on)}$, shoot-through immunity, body diode characteristics and ultra-low gate resistance. This device is ideally suited for use as a low side switch in Notebook CPU core power conversion.

APPLICATIONS

- Battery Switch
- Load Switch

MARKING



Front side

Q4435= Device code
 Solid dot=Pin1 indicator
 Solid dot = Green molding compound device,
 if none, the normal device
 YY=Date Code

Equivalent Circuit

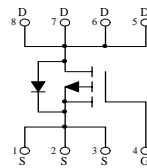

MAXIMUM RATINGS ($T_a=25^\circ\text{C}$ unless otherwise noted)

Parameter	Symbol	Limit	Unit
Drain-Source Voltage	V_{DS}	-30	V
Gate-Source Voltage	V_{GS}	± 20	V
Continuous Drain Current	I_D	-9.1	A
Pulsed Drain Current	I_{DM}	-36	A
Single Pulsed Avalanche Energy	$E_{AS}^{(1)}$	20	mJ
Power Dissipation	P_D	1.4	W
Thermal Resistance from Junction to Ambient	$R_{\theta JA}$	89	$^\circ\text{C/W}$
Junction Temperature	T_J	150	$^\circ\text{C}$
Storage Temperature Range	T_{stg}	-55 ~ +150	$^\circ\text{C}$
Lead Temperature for Soldering Purposes(1/8" from case for 10s)	T_L	260	$^\circ\text{C}$

(1). E_{AS} condition: $V_{DD}=-50V, L=0.5mH, R_G=25\Omega$, Starting $T_J = 25^\circ\text{C}$

MOSFET ELECTRICAL CHARACTERISTICS

$T_a=25\text{ }^\circ\text{C}$ unless otherwise specified

Parameter	Symbol	Test Condition	Min	Typ	Max	Unit
Off characteristics						
Drain-source breakdown voltage	$V_{(BR)DSS}$	$V_{GS} = 0V, I_D = -250\mu A$	-30			V
Zero gate voltage drain current	I_{DSS}	$V_{DS} = -30V, V_{GS} = 0V$			-1	μA
Gate-body leakage current	I_{GSS}	$V_{DS} = 0V, V_{GS} = \pm 20V$			± 100	nA
On characteristics (note1)						
Gate-threshold voltage	$V_{GS(th)}$	$V_{DS} = V_{GS}, I_D = -250\mu A$	-1.0	-1.5	-3.0	V
Static drain-source on-state resistance	$R_{DS(on)}$	$V_{GS} = -10V, I_D = -9.1A$		14	24	m Ω
		$V_{GS} = -4.5V, I_D = -6.9A$		23	35	m Ω
Forward transconductance	g_{fs}	$V_{DS} = -10V, I_D = -9.1A$	20			S
Dynamic characteristics (note 2)						
Input capacitance	C_{iss}	$V_{DS} = -15V, V_{GS} = 0V,$ $f = 1MHz$		1350		pF
Output capacitance	C_{oss}			215		
Reverse transfer capacitance	C_{rss}			185		
Switching characteristics (note 2)						
Total gate charge	Q_g	$V_{DS} = -15V, V_{GS} = -10V,$ $I_D = -9.1A$			50	nC
		$V_{DS} = -15V, V_{GS} = -4.5V,$ $I_D = -9.1A$			25	
Gate-source charge	Q_{gs}			4		
Gate-drain charge	Q_{gd}			7.5		
Turn-on delay time	$t_{d(on)}$	$V_{DD} = -15V, I_D = -1A,$ $V_{GS} = -10V, R_G = 1\Omega,$ $R_L = 15\Omega$			15	ns
Turn-on rise time	t_r				15	
Turn-off delay time	$t_{d(off)}$				70	
Turn-off fall time	t_f				25	
Gate Resistance	R_g	$f = 1MHz, V_{DS} = 0V,$ $V_{GS} = 0V,$		5.8		Ω
Drain-Source Diode Characteristics						
Drain-source diode forward voltage(note1)	V_{SD}	$V_{GS} = 0V, I_S = -2A$			-1.2	V
Continuous drain-source diode forward current	I_S				-9.1	A
Pulsed drain-source diode forward current	I_{SM}				-36	A

Notes:

1. Pulse Test : Pulse Width $\leq 300\mu s$, duty cycle $\leq 2\%$.
2. Guaranteed by design, not subject to production testing.

TYPICAL CHARACTERISTICS

Output Characteristics

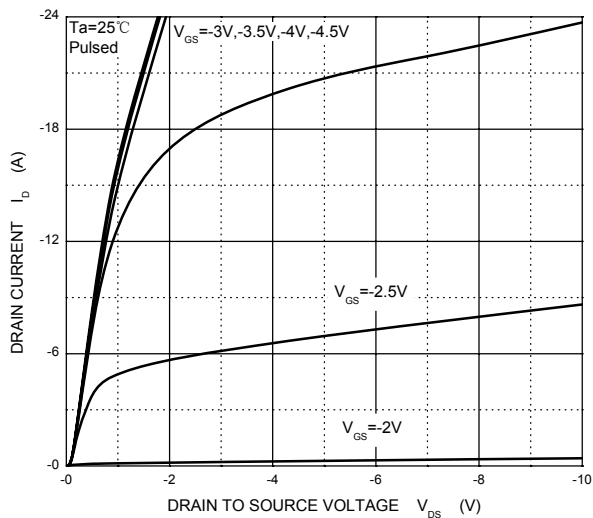

Transfer Characteristics

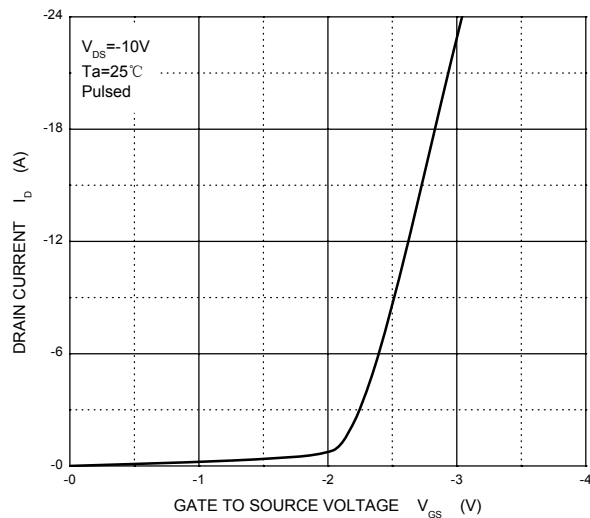

$R_{DS(ON)}$ — I_D

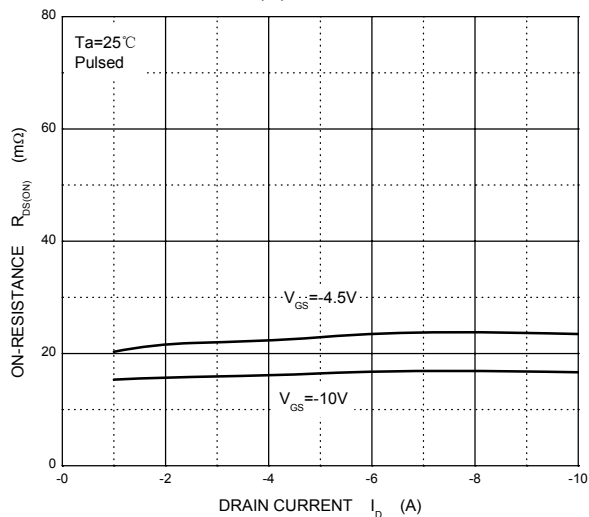

$R_{DS(ON)}$ — V_{GS}

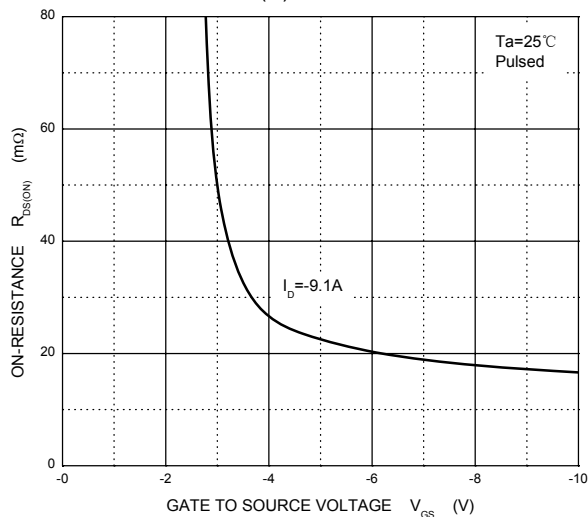

Threshold Voltage

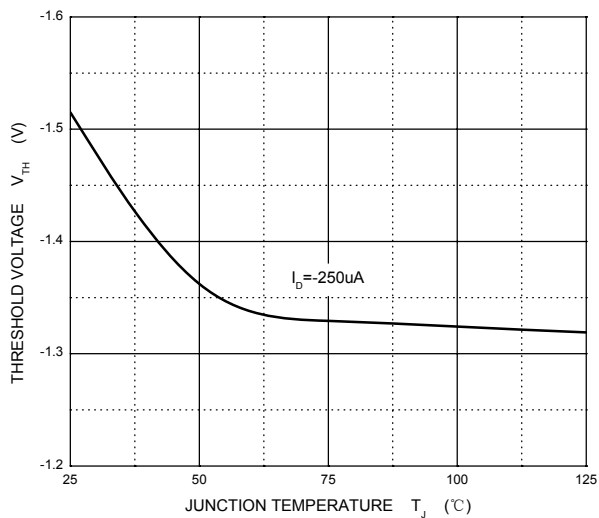

I_S — V_{SD}

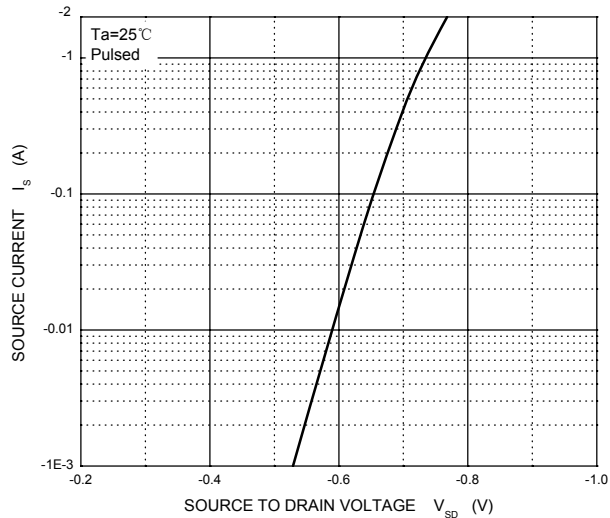

SOP8 Package Outline Dimensions

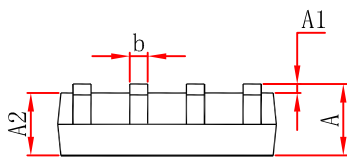
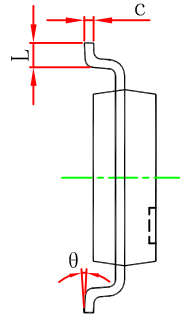
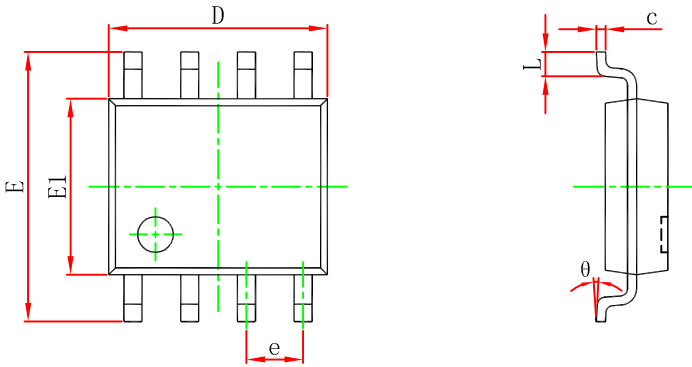

Symbol	Dimensions In Millimeters		Dimensions In Inches	
	Min	Max	Min	Max
A	1.350	1.750	0.053	0.069
A1	0.100	0.250	0.004	0.010
A2	1.350	1.550	0.053	0.061
b	0.330	0.510	0.013	0.020
c	0.170	0.250	0.007	0.010
D	4.800	5.000	0.189	0.197
e	1.270 (BSC)		0.050 (BSC)	
E	5.800	6.200	0.228	0.244
E1	3.800	4.000	0.150	0.157
L	0.400	1.270	0.016	0.050
θ	0°	8°	0°	8°

SOP8 Suggested Pad Layout

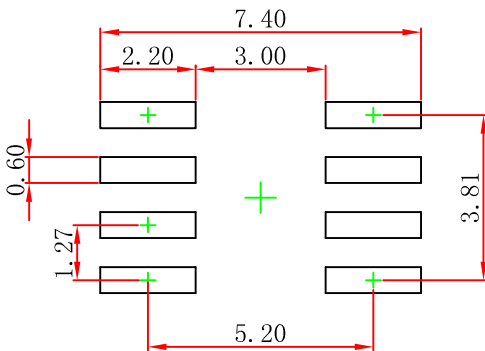

- Note:
1. Controlling dimension: in millimeters.
 2. General tolerance: ± 0.05 mm.
 3. The pad layout is for reference purposes only.

NOTICE

JCET reserve the right to make modifications, enhancements, improvements, corrections or other changes without further notice to any product herein. JCET does not assume any liability arising out of the application or use of any product described herein.

SOP8 Tape and Reel

SOP8 Embossed Carrier Tape

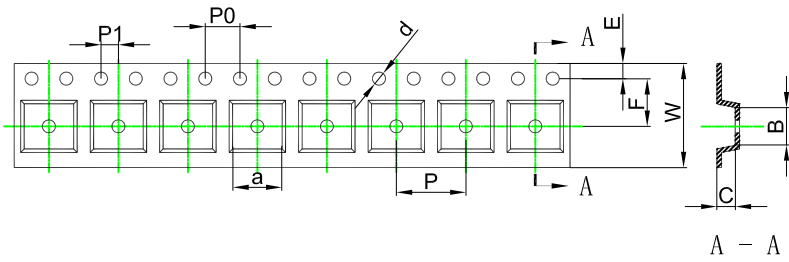

Packaging Description:
 SOP8 parts are shipped in tape. The carrier tape is made from a dissipative (carbon filled) polycarbonate resin. The cover tape is a multilayer film (Heat Activated Adhesive in nature) primarily composed of polyester film, adhesive layer, sealant, and anti-static sprayed agent. These reeled parts in standard option are shipped with 2,500 units per 13" or 33cm diameter reel. The reels are clear in color and is made of polystyrene plastic (anti-static coated).
ALL DIM IN mm

Dimensions are in millimeter										
Pkg type	a	B	C	d	E	F	P0	P	P1	W
SOP8	6.40	5.40	2.10	Ø1.50	1.75	5.50	4.00	8.00	2.00	12.00

SOP8 Tape Leader and Trailer

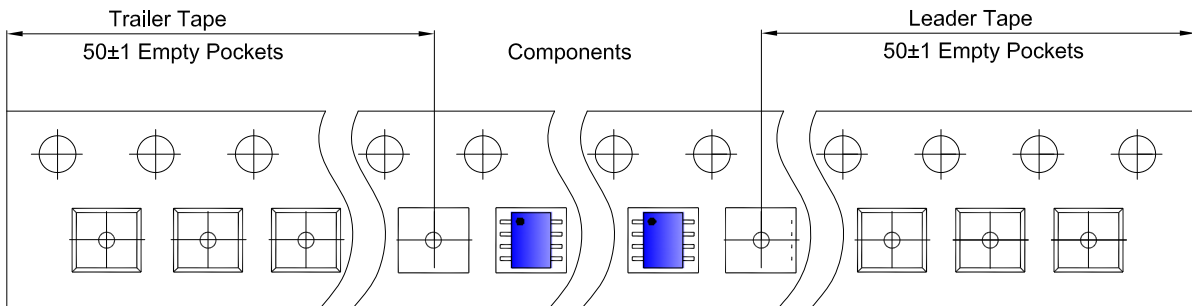

SOP8 Reel

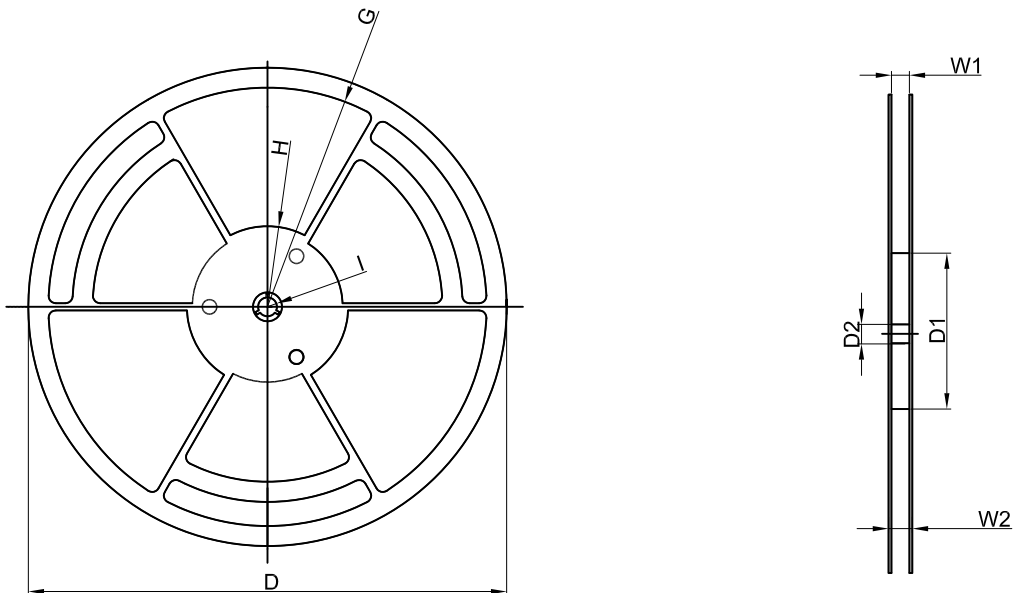

Dimensions are in millimeter								
Reel Option	D	D1	D2	G	H	I	W1	W2
13" Dia	Ø330.00	100.00	13.00	R151.00	R56.00	R6.50	12.40	17.60

REEL	Reel Size	Box	Box Size(mm)	Carton	Carton Size(mm)	G.W.(kg)
4,000 pcs	13 inch	8,000 pcs	360×360×65	64,000 pcs	565×380×390	

X-ON Electronics

Largest Supplier of Electrical and Electronic Components

Click to view similar products for [MOSFET](#) category:

Click to view products by [Changjiang](#) manufacturer:

Other Similar products are found below :

[614233C](#) [648584F](#) [MCH3443-TL-E](#) [MCH6422-TL-E](#) [FDPF9N50NZ](#) [FW216A-TL-2W](#) [FW231A-TL-E](#) [APT5010JVR](#) [NTNS3A92PZT5G](#)
[IRF100S201](#) [JANTX2N5237](#) [2SK2464-TL-E](#) [2SK3818-DL-E](#) [FCA20N60_F109](#) [FDZ595PZ](#) [STD6600NT4G](#) [FSS804-TL-E](#) [2SJ277-DL-E](#)
[2SK1691-DL-E](#) [2SK2545\(Q,T\)](#) [405094E](#) [423220D](#) [MCH6646-TL-E](#) [TPCC8103,L1Q\(CM](#) [367-8430-0972-503](#) [VN1206L](#) [424134F](#)
[026935X](#) [051075F](#) [SBVS138LT1G](#) [614234A](#) [715780A](#) [NTNS3166NZT5G](#) [751625C](#) [873612G](#) [IRF7380TRHR](#) [IPS70R2K0CEAKMA1](#)
[RJK60S3DPP-E0#T2](#) [RJK60S5DPK-M0#T0](#) [APT5010JVFR](#) [APT12031JFLL](#) [APT12040JVR](#) [DMN3404LQ-7](#) [NTE6400](#) [JANTX2N6796U](#)
[JANTX2N6784U](#) [JANTXV2N5416U4](#) [SQM110N05-06L-GE3](#) [SIHF35N60E-GE3](#) [2SK2614\(TE16L1,Q\)](#)