

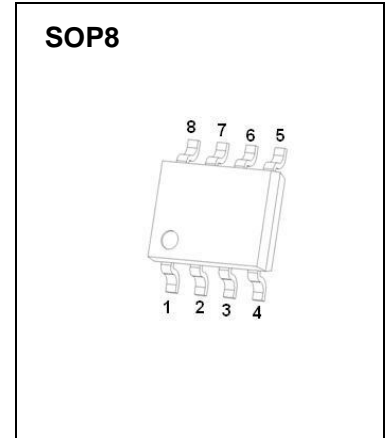

SOP8 Plastic-Encapsulate MOSFETS

CJQ4438 N-Channel MOSFET

$V_{(BR)DSS}$	$R_{DS(on)MAX}$	I_D
60V	22mΩ@10V	8.2A
	36mΩ@4.5V	



FEATURE

- TrenchFET Power MOSFET
- Low $R_{DS(on)}$
- Low Gate Charge

APPLICATION

- Load Switch
- PWM applications

MARKING

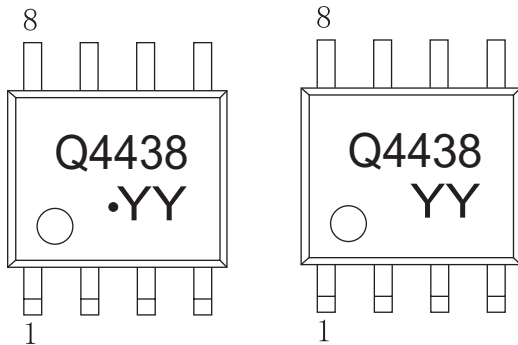

Front side

Q4438 = Device code

Solid dot=Pin1 indicator

Solid dot = Green molding compound device,
if none, the normal device

YY=Date Code

Equivalent Circuit

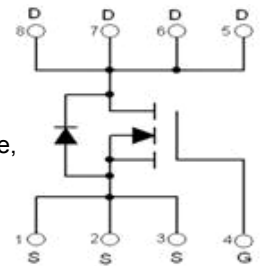

Maximum ratings ($T_a=25^{\circ}C$ unless otherwise noted)

Parameter	Symbol	Value	Unit
Drain-Source Voltage	V_{DS}	60	V
Gate-Source Voltage	V_{GS}	±20	V
Continuous Drain Current (note 1)	I_D	8.2	A
Pulsed Drain Current (note 2)	I_{DM}	40	A
Power Dissipation	P_D	1.25	W
Thermal Resistance from Junction to Ambient (note 1)	$R_{\theta JA}$	100	$^{\circ}C/W$
Junction Temperature	T_J	150	$^{\circ}C$
Storage Temperature	T_{STG}	-55~+150	$^{\circ}C$

MOSFET ELECTRICAL CHARACTERISTICS

T_a =25 °C unless otherwise specified

Parameter	Symbol	Test Condition	Min	Typ	Max	Unit
STATIC PARAMETERS						
Drain-source breakdown voltage	V _{(BR)DSS}	V _{GS} = 0V, I _D =250μA	60			V
Zero gate voltage drain current	I _{DSS}	V _{DS} =60V, V _{GS} = 0V			1	μA
Gate-body leakage current	I _{GSS}	V _{GS} =±20V, V _{DS} = 0V			±100	nA
Gate threshold voltage	V _{GS(th)}	V _{DS} =V _{GS} , I _D =250μA	1		3	V
Drain-source on-resistance (note 3)	R _{DS(on)}	V _{GS} =10V, I _D =8.2A			22	mΩ
		V _{GS} =4.5V, I _D =7.6A			36	mΩ
Forward tranconductance (note 3)	g _{fs}	V _{DS} =5V, I _D =8.2A	10			S
Diode forward voltage (note 3)	V _{SD}	I _S =1A, V _{GS} = 0V			1	V
DYNAMIC PARAMETERS (note 4)						
Input Capacitance	C _{iss}	V _{DS} =30V, V _{GS} =0V, f =1MHz			2300	pF
Output Capacitance	C _{oss}			155		pF
Reverse Transfer Capacitance	C _{rss}			116		pF
SWITCHING PARAMETERS (note 4)						
Turn-on delay time	t _{d(on)}	V _{GS} =10V, V _{DS} =30V R _L =3.6Ω, R _{GEN} =3Ω		8.2		ns
Turn-on rise time	t _r			5.5		ns
Turn-off delay time	t _{d(off)}			29.7		ns
Turn-off fall time	t _f			5.2		ns
Total Gate Charge (10V)	Q _g	V _{DS} =30V, V _{GS} =10V, I _D =8.2A			58	nC
Total Gate Charge (4.5V)					30	nC
Gate-Source Charge	Q _{gs}			6		nC
Gate-Drain Charge	Q _{gd}			14.4		nC

Notes :

1. The value of R_{θJA} is measured with the device mounted on 1 in² FR4 board with 2oz. Copper, in a still air environment with T_a=25°C. The value in any given application depends on the user's specific board design. The current rating is based on the t ≤10s thermal resistance rating.
2. Repetitive rating : Pulse width limited by junction temperature.
3. Pulse Test : Pulse Width ≤300μs, Duty Cycle ≤2%.
4. These parameters have no way to verify.

Typical Characteristics

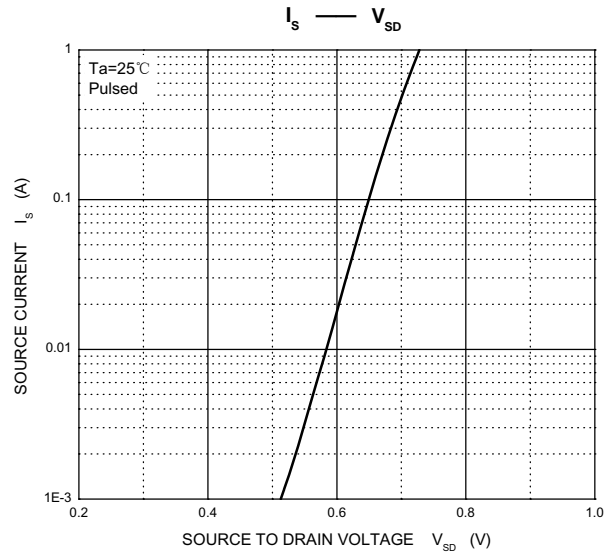
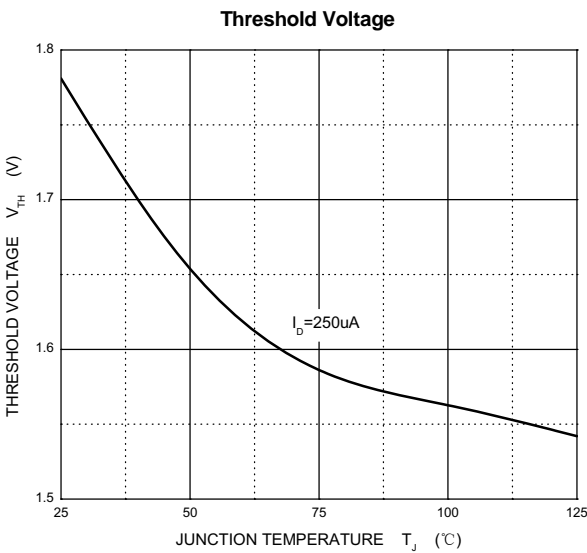
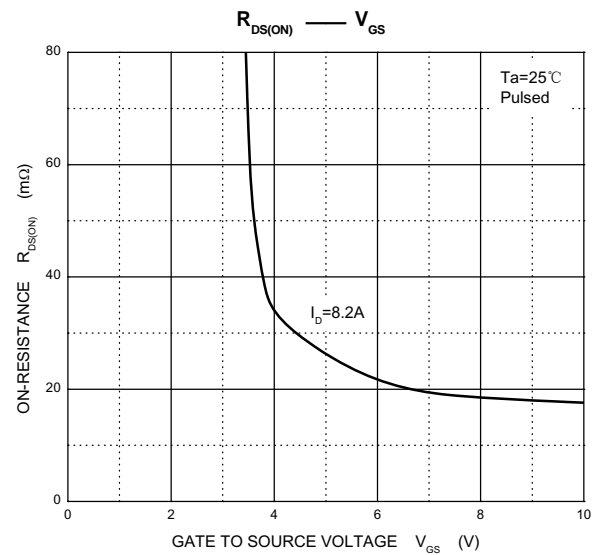
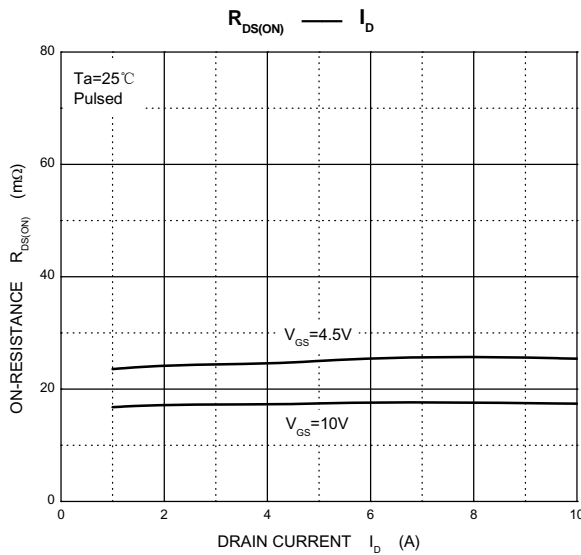
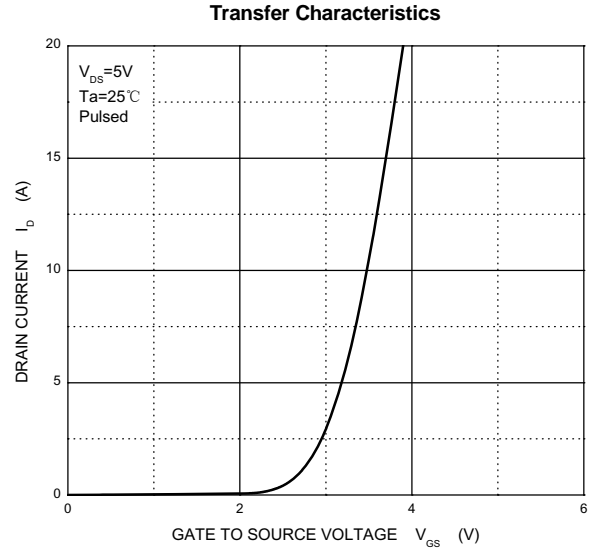
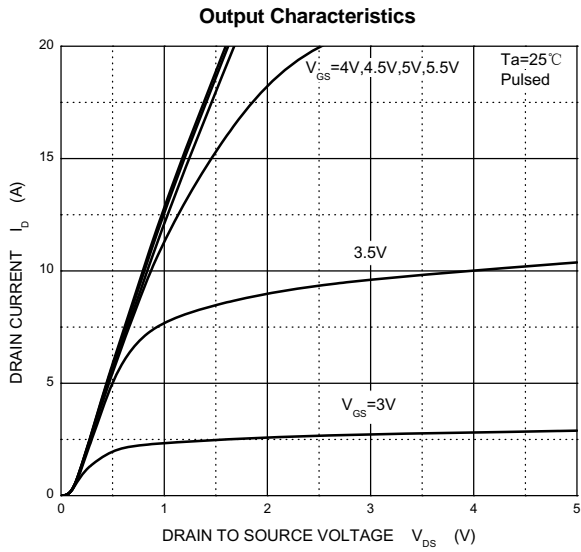

SOP8 Package Outline Dimensions

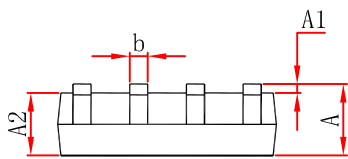
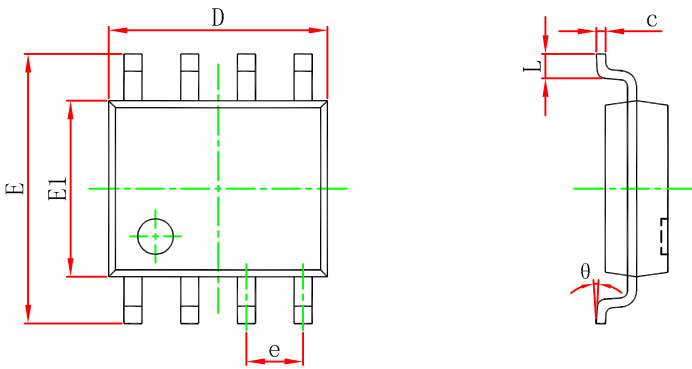

Symbol	Dimensions In Millimeters		Dimensions In Inches	
	Min	Max	Min	Max
A	1.350	1.750	0.053	0.069
A1	0.100	0.250	0.004	0.010
A2	1.350	1.550	0.053	0.061
b	0.330	0.510	0.013	0.020
c	0.170	0.250	0.007	0.010
D	4.800	5.000	0.189	0.197
e	1.270 (BSC)		0.050 (BSC)	
E	5.800	6.200	0.228	0.244
E1	3.800	4.000	0.150	0.157
L	0.400	1.270	0.016	0.050
theta	0°	8°	0°	8°

SOP8 Suggested Pad Layout

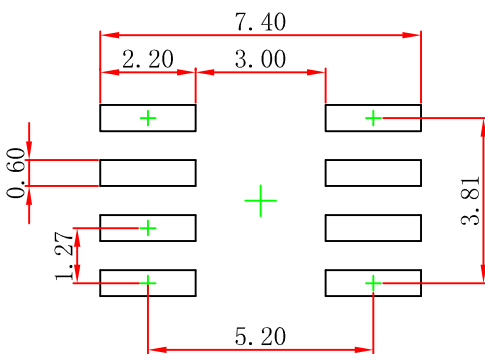

Note:

1. Controlling dimension: in millimeters.
2. General tolerance: $\pm 0.05\text{mm}$.
3. The pad layout is for reference purposes only.

NOTICE

JCET reserve the right to make modifications, enhancements, improvements, corrections or other changes without further notice to any product herein. JCET does not assume any liability arising out of the application or use of any product described herein.

SOP8 Tape and Reel

SOP8 Embossed Carrier Tape

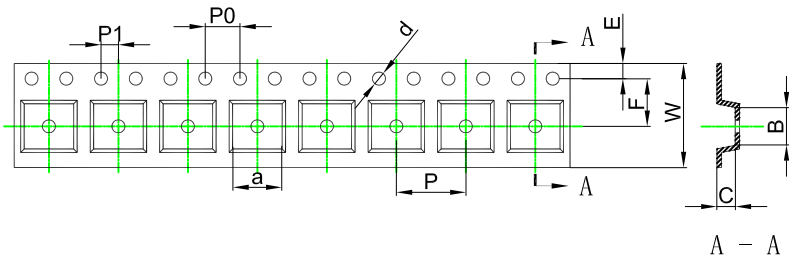

Packaging Description:

SOP8 parts are shipped in tape. The carrier tape is made from a dissipative (carbon filled) polycarbonate resin. The cover tape is a multilayer film (Heat Activated Adhesive in nature) primarily composed of polyester film, adhesive layer, sealant, and anti-static sprayed agent. These reeled parts in standard option are shipped with 2,500 units per 13" or 33cm diameter reel. The reels are clear in color and is made of polystyrene plastic (anti-static coated).

ALL DIM IN mm

Dimensions are in millimeter										
Pkg type	a	B	C	d	E	F	P0	P	P1	W
SOP8	6.40	5.40	2.10	Ø1.50	1.75	5.50	4.00	8.00	2.00	12.00

SOP8 Tape Leader and Trailer



SOP8 Reel

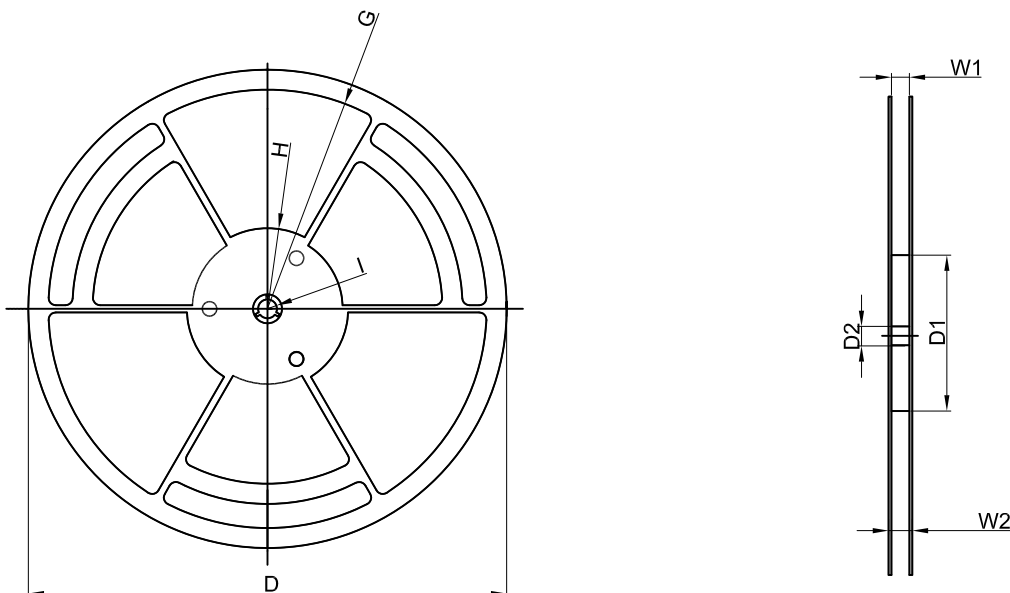

Dimensions are in millimeter								
Reel Option	D	D1	D2	G	H	I	W1	W2
13" Dia	Ø330.00	100.00	13.00	R151.00	R56.00	R6.50	12.40	17.60

REEL	Reel Size	Box	Box Size(mm)	Carton	Carton Size(mm)	G.W.(kg)
4,000 pcs	13 inch	8,000 pcs	360×360×65	64,000 pcs	565×380×390	

X-ON Electronics

Largest Supplier of Electrical and Electronic Components

Click to view similar products for [MOSFET](#) category:

Click to view products by [Changjiang](#) manufacturer:

Other Similar products are found below :

[614233C](#) [648584F](#) [MCH3443-TL-E](#) [MCH6422-TL-E](#) [FDPF9N50NZ](#) [FW216A-TL-2W](#) [FW231A-TL-E](#) [APT5010JVR](#) [NTNS3A92PZT5G](#)
[IRF100S201](#) [JANTX2N5237](#) [2SK2464-TL-E](#) [2SK3818-DL-E](#) [FCA20N60_F109](#) [FDZ595PZ](#) [STD6600NT4G](#) [FSS804-TL-E](#) [2SJ277-DL-E](#)
[2SK1691-DL-E](#) [2SK2545\(Q,T\)](#) [405094E](#) [423220D](#) [MCH6646-TL-E](#) [TPCC8103,L1Q\(CM](#) [367-8430-0972-503](#) [VN1206L](#) [424134F](#)
[026935X](#) [051075F](#) [SBVS138LT1G](#) [614234A](#) [715780A](#) [NTNS3166NZT5G](#) [751625C](#) [873612G](#) [IRF7380TRHR](#) [IPS70R2K0CEAKMA1](#)
[RJK60S3DPP-E0#T2](#) [RJK60S5DPK-M0#T0](#) [APT5010JVFR](#) [APT12031JFLL](#) [APT12040JVR](#) [DMN3404LQ-7](#) [NTE6400](#) [JANTX2N6796U](#)
[JANTX2N6784U](#) [JANTXV2N5416U4](#) [SQM110N05-06L-GE3](#) [SIHF35N60E-GE3](#) [2SK2614\(TE16L1,Q\)](#)