



Thick Film Chip Resistors (Lead-Free for RM series standard) Halogen-Free

Document No.	TRM-XX0S002I
Revise Date	2017/09/04
page number	1/13

1. Scope :

This specification applies for the RM series of thick film chip resistors made by TA-I.

2. Construction :

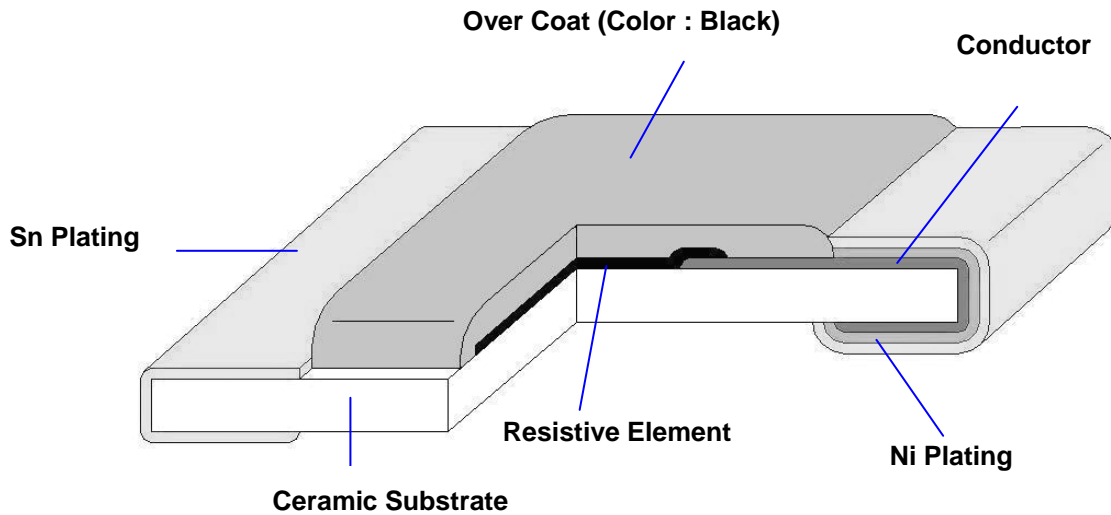

3. Type Designation :

<u>RM</u>	<u>10</u>	<u>J</u>	<u>TN</u>	<u>103</u>
Product Code	Size	Tolerance	Packaging	Nominal Resistance
RM : Chip Resistor	Power Rating			

01-01005(0402) 1/32W 02-0201(0603) 1/20W 04-0402(1005) 1/16W 06-0603(1608) 1/10W 10-0805(2012) 1/8W 12-1206(3216) 1/4W 13-1210(3226) 1/3W 20-2010(5025) 3/4W 25-2512(6432) 1 W	J-±5% G-±2% F-±1% D-±0.5% B-±0.1%	T-Paper Tape E-Embossed Tape <hr/> +N : Lead-Free	3 digits, e.g.,: (E-24) 103 = 10kΩ 0 = 0Ω 4 digits, e.g., : (E-96) 1540 = 154Ω 43R2 = 43.2Ω
--	---	---	--



Thick Film Chip Resistors
 (Lead-Free for RM series standard)
Halogen-Free

Document No.	TRM-XX0S002I
Revise Date	2017/09/04
page number	2/13

4. Dimensions :



UNIT: mm

Type	L	W	C	d	t
RM01	0.4 ±0.02	0.2 ±0.02	0.1 ±0.03	0.1±0.03	0.13 ±0.02
RM02	0.60±0.03	0.30±0.03	0.1±0.05	0.15±0.05	0.23±0.03
RM04	^{+0.1} 1.00 _{-0.05}	0.50±0.05	0.20±0.10	0.25±0.10	0.32±0.05
RM06	1.60±0.10	0.80±0.10	0.30±0.20	^{+0.2} 0.30 _{-0.1}	0.45±0.10
RM10	2.00±0.10	1.25±0.10	0.40±0.20	0.40±0.20	0.50±0.10
RM12	3.10±0.10	1.55±0.10	0.50±0.30	0.40±0.20	0.55±0.10
RM13	3.10±0.10	2.55±0.10	0.50±0.30	0.40±0.20	0.60±0.10
RM20	5.00±0.15	2.50±0.15	0.60±0.30	0.50±0.25	0.60±0.10
RM25	6.30±0.20	3.20±0.20	0.60±0.30	0.50±0.25	0.60±0.10



Thick Film Chip Resistors (Lead-Free for RM series standard) Halogen-Free

Document No.	TRM-XX0S0021
Revise Date	2017/09/04
page number	3/13

5. Ratings & Characteristics :

Type	Power Rating at 70°C	Rating Voltage	Max. Working Voltage	Max. Over-Load Voltage	T.C.R (PPM/°C)	Resistance Range(Ω)				
						B(±0.1%) E-96&E-24	D(±0.5%) E-96&E-24	F(±1%) E-96&E-24	G(±2%) E-24	J(±5%) E-24
RM01	1/32W	Refer 5.2	15V	30V	±300			10Ω ≤ R < 100Ω	10Ω ≤ R < 100Ω	10Ω ≤ R < 100Ω
					±200			100Ω ≤ R ≤ 1MΩ	100Ω ≤ R ≤ 1MΩ	100Ω ≤ R ≤ 1MΩ
RM02	1/20W	Refer 5.2	25V	50V	±200	100Ω-10KΩ		10Ω-3MΩ	10Ω-3MΩ	10Ω-10MΩ
					+600 -200			1-9.1Ω	1-9.1Ω	1-9.1Ω
RM04	1/16W	Refer 5.2	50V	100V	±100	100Ω~499KΩ	100Ω~1MΩ	100Ω~1MΩ		
					±200	10Ω ≤ R < 100Ω	10Ω ≤ R < 100Ω	10Ω ≤ R < 100Ω 1MΩ < R ≤ 10MΩ	10Ω-10MΩ	10Ω-10MΩ
					+500 -200			1Ω-9.1Ω	1Ω-9.1Ω	1Ω-9.1Ω
					±400				10MΩ ≤ R ≤ 20MΩ	10MΩ ≤ R ≤ 20MΩ
RM06	1/10W	Refer 5.2	75V	150V	±100	10Ω-560kΩ	10Ω-1MΩ	10Ω-1MΩ		
					±200			1M < R ≤ 10MΩ	10Ω-10MΩ	10Ω-10MΩ
					±400			1Ω-9.1Ω	1Ω-9.1Ω	1Ω-9.1Ω 10MΩ < R ≤ 20MΩ
RM10	1/8W	Refer 5.2	150V	300V	±100	10Ω-560kΩ	10Ω-1MΩ	10Ω-1MΩ		
					±200			1M < R ≤ 10MΩ	10Ω-10MΩ	10Ω-10MΩ
					±400			1Ω-9.1Ω	1Ω-9.1Ω	1Ω-9.1Ω 10MΩ < R ≤ 20MΩ
RM12	1/4W	Refer 5.2	200V	400V	±100	10Ω-560kΩ	10Ω-1MΩ	10Ω-1MΩ		
					±200			1M < R ≤ 10MΩ	10Ω-10MΩ	10Ω-10MΩ
					±400			1Ω-9.1Ω	1Ω-9.1Ω	1Ω-9.1Ω 10MΩ < R ≤ 20MΩ
RM13	1/3W	Refer 5.2	200V	400V	±100	10Ω-560kΩ	10Ω-1MΩ	10Ω-1MΩ		
					±200			1M < R ≤ 10MΩ	10Ω-10MΩ	10Ω-10MΩ
					±400			1Ω-9.1Ω	1Ω-9.1Ω	1Ω-9.1Ω 10MΩ < R ≤ 20MΩ
RM20	3/4W	Refer 5.2	200V	400V	±100	10Ω-560kΩ	10Ω-1MΩ	10Ω-1MΩ		
					±200			1M < R ≤ 10MΩ	10Ω-10MΩ	10Ω-10MΩ
					±400			1Ω-9.1Ω	1Ω-9.1Ω	1Ω-9.1Ω 10M < R ≤ 20MΩ
RM25	1W	Refer 5.2	200V	400V	±100	10Ω-560kΩ	10Ω-1MΩ	10Ω-1MΩ		
					±200			1M < R ≤ 10MΩ	10Ω-10MΩ	10Ω-10MΩ
					±400			1Ω-9.1Ω	1Ω-9.1Ω	1Ω-9.1Ω 10M < R ≤ 20MΩ

Ω THICK FILM CHIP RESISTORS

Type	Rated Current	Max Overload Current	Resistance Range
RM01	0.5A	1A	50mΩ MAX
RM02	0.5A	1A	50mΩ MAX
RM04	1A	2.5A	50mΩ MAX
RM06	1A	2.5A	50mΩ MAX
RM10	2A	5A	50mΩ MAX
RM12	2A	5A	50mΩ MAX
RM13	2A	5A	50mΩ MAX
RM20	2A	5A	50mΩ MAX
RM25	2A	5A	50mΩ MAX

Operating Temp (°C) : -55°C ~ +155°C (RM01 / 02 : -55°C ~ +125°C)

Note : Except for the above standardized products, we also provide the customized products.



Thick Film Chip Resistors
(Lead-Free for RM series standard)
Halogen-Free

Document No.	TRM-XX0S002I
Revise Date	2017/09/04
page number	4/13

5.1. Derating Curve :

For resistors operated at ambient temperature over 70°C , power rating shall be derated in accordance with figure 1.



Figure 1

5.2. Rated Voltage :

The rated voltage is calculated by the following formula:

$$E = \sqrt{P * R}$$

E=Rated Voltage(V)
P=Rated Power(W)
R=Resistance Value(Ω)

E.G. : What is RM06JTN102 the rated voltage ?

RM06JTN102 P:1/10W ; R:102 = 1KΩ = 1000Ω

$$E = \sqrt{0.1(W) * 1000(\Omega)} = 10 (V)$$



Thick Film Chip Resistors (Lead-Free for RM series standard) Halogen-Free

Document No.	TRM-XX0S0021
Revise Date	2017/09/04
page number	5/13

6. Reliability Tests :

Test Items	Reference standard	Condition of Test	Test Limits ΔR
Temperature Coefficient of Resistance	IEC60115-1-4.8 JIS-C5201-1-4.8	-55~ +125 °C	Refer 5.0
Short Time Overload	IEC60115-1-4.13 JIS-C5201-1-4.13	2.5 X rated voltage for 5 sec	$\pm(1\% + 0.05\Omega)$ Remarks : 01005& 0201 : $\pm(3\% + 0.1\Omega)$ 0402 : $\pm(2\% + 0.1\Omega)$ 0 Ω : 50m Ω or less
Intermittent Overload	IEC60115-1-4.39 JIS-C5201-1-4.39	3.0 X rated voltage or Max Overloading voltage ,1sec "ON" , 25sec "OFF" , 10000 cycles (Remarks : 01005 & 0201-NA , 0402 2.5 X RCWV *)	$\pm (5.0\% + 0.1\Omega)$ 0 Ω : 50m Ω or less
Endurance (Load Life)	IEC60115-1-4.25.1 JIS-C5201-1-4.25.1	1000 hours at rated voltage, 70°C , 1.5hours "ON" , 0.5hour "OFF"	0.1%,0.5%,1%: $\pm(1.0\%+0.05\Omega)$ 2%,5%: $\pm(3.0\%+0.1\Omega)$ Remarks : 01005& 0201 : $\pm(5.0\%+0.1\Omega)$ 0402 : $\pm(3.0\%+0.1\Omega)$ 0 Ω : 100m Ω or less
Load Life with Humidity	IEC60115-1-4.24 JIS-C5201-1-4.24	1000 hours at rated voltage , 40 \pm 2°C , 90~95% RH 1.5hours "ON" , 0.5hour "OFF"	0.1%,0.5%,1%: $\pm(1.0\%+0.05\Omega)$ 2% , 5%: $\pm(3.0\%+0.1\Omega)$ Remarks : 01005&0201: $\pm(5.0\%+0.1\Omega)$ 0402: $\pm(3.0\%+0.1\Omega)$ 0 Ω : 100m Ω or less
Rapid Change of Temperature	IEC60115-1-4.19 JIS-C5201-1-4.19	-55°C (30 min.) / +155 °C(30 min.) 5 cycles	0.1%,0.5%,1%: $\pm(0.5\%+0.05\Omega)$ 2% , 5%: $\pm(1.0\%+0.05\Omega)$ Remarks : 01005& 0201: $\pm(3.0\%+0.1\Omega)$ 0 Ω : 50m Ω or less
Solderability	IEC60115-1-4.17 JIS-C5201-1-4.17	245 \pm 5°C solder, 2 \pm 0.5 sec dwell. Solder : Sn96.5 / Ag3.0 / Cu0.5	At least 95% of surface area of electrode shall be covered with new solder.
Robustness of Termination (Bending)	IEC60115-1-4.33 JIS-C5201-1-4.33	3mm deflection 2mm deflection (RM20,25)	0.1%,0.5%,1%: $\pm(0.5\%+0.05\Omega)$ 2%,5%: $\pm(1.0\%+0.05\Omega)$ Remarks : 01005& 0201 $\pm(1.0\%+0.1\Omega)$ 0 Ω : 50m Ω or less
Dielectric Withstanding Voltage (Voltage Proof)	IEC60115-1-4.7 JIS-C5201-1-4.7	Applying voltage : 01005 & 0201 : 50V , 0402 & 0603 : 300V The other 500V for a minute .	No abnormalities such as flashover, burning dielectric breakdown shall appear.
Insulation Resistance	IEC60115-1-4.6 JIS-C5201-1-4.6	Applying voltage 100V for 1 minute. Remark : 01005 & 0201 50V	$\geq 1G\Omega$ Remarks : 01005 : $\geq 100M\Omega$
Resistance to Dry Heat	IEC60115-1-4.23.2 JIS-C5201-1-4.23.2	155 \pm 5°C for 96 \pm 4Hrs Remark : 01005 & 0201 125 \pm 5°C	0.1%,0.5%,1%: $\pm(1.0\%+0.05\Omega)$ 2%,5%: $\pm(2.0\%+0.1\Omega)$ Remark : 01005 : $\pm(3.0\%+0.1\Omega)$ 0201 : $\pm(2.0\%+0.1\Omega)$ 0 Ω : 50m Ω or less
Resistance to Solder Heat	IEC60115-1-4.18 JIS-C5201-1-4.18	270 \pm 5°C solder , 10 \pm 1 sec dwell .	0.1%,0.5%,1%: $\pm(0.5\%+0.05\Omega)$ 2% , 5%: $\pm(1.0\%+0.05\Omega)$ Remarks : 01005 : $\pm(3.0\%+0.05\Omega)$ 0201 $\pm(3.0\%+0.1\Omega)$ 0 Ω : 50m Ω or less

Note* : RCWV : Rated continuous working voltage .



Thick Film Chip Resistors
(Lead-Free for RM series standard)
Halogen-Free

Document No.	TRM-XX0S002I
Revise Date	2017/09/04
page number	6/13

7. Marking

7.1 ±2% & ±5%(E24) : RM06 / RM10 / RM12 / RM13 / RM20 / RM25

Resistance value is expressed by 3 digits, the first two digits represent the significant figures of nominal resistance value in Ω, and the third digit represents exponent for base of 10.

E.G. : 102 = 10×10² = 1000Ω = 1KΩ



Notes :

RM06 : R represents the 「 · 」

7.2 ±0.1% , ±0.5% , ±1% (E96) : RM10 / RM12 / RM13 / RM20 / RM25

Resistance value is expressed by 4 digits , the first three digits represent the significant figures of nominal resistance value in Ω, and the fourth digit represents exponent for base of 10.

E.G. : 1000 = 100×10⁰ = 100Ω



7.3 ±0.1% , ±0.5% , ±1% (E96): RM06

When the marking space is too small in such small-sized resistors as RM06, the marking can not made by 4 digits and may be made by two digits combined with one English capital.

Symbol for E96 series nominal resistance value

Symbol	E96	Symbol	E96	Symbol	E96	Symbol	E96
01	100	25	178	49	316	73	562
02	102	26	182	50	324	74	576
03	105	27	187	51	332	75	590
04	107	28	191	52	340	76	604
05	110	29	196	53	348	77	619
06	113	30	200	54	357	78	634
07	115	31	205	55	365	79	649
08	118	32	210	56	374	80	665
09	121	33	215	57	383	81	681
10	124	34	221	58	392	82	698
11	127	35	226	59	402	83	715
12	130	36	232	60	412	84	732
13	133	37	237	61	422	85	750
14	137	38	243	62	432	86	768
15	140	39	249	63	442	87	787
16	143	40	255	64	453	88	806



Thick Film Chip Resistors
(Lead-Free for RM series standard)
Halogen-Free

Document No.	TRM-XX0S002I
Revise Date	2017/09/04
page number	7/13

17	147	41	261	65	464	89	825
18	150	42	267	66	475	90	845
19	154	43	274	67	487	91	866
20	158	44	280	68	499	92	887
21	162	45	287	69	511	93	909
22	165	46	294	70	523	94	931
23	169	47	301	71	536	95	953
24	174	48	309	72	549	96	976

Symbol for multipliers

Symbol	A	B	C	D	E	F	G	H	X	Y	Z
multipliers	10 ⁰	10 ¹	10 ²	10 ³	10 ⁴	10 ⁵	10 ⁶	10 ⁷	10 ⁻¹	10 ⁻²	10 ⁻³

E.G : 01A = 100×10⁰ = 100Ω



Notes :

When the resistance value is not in the list of E96 , 3 digitals with underline in E-24 series is used as mark .

E.G. : 0603 , 120Ω , 1% Marking is 121

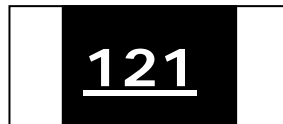

7.4 ±0.1% , ±0.5% , ±1%(E96/3digitals)

The resistance value by 3 digitals is requirement for customer.

7.5 RM06 / RM10 / RM12 / RM13 / RM20 / RM25

E.G. : 0 = 0Ω



7.6 No Marking for RM01 & RM02 & RM04



Thick Film Chip Resistors
(Lead-Free for RM series standard)
Halogen-Free

Document No.	TRM-XX0S002I
Revise Date	2017/09/04
page number	8/13

8. Taping & Reel :

8.1 Taping Dimensions

8.1.1 4 mm pitch paper:



Packing	Type	A	B	W	F	E	P_1	P_2	P_0	D_0	T
Paper	RM06	1.1±0.1	1.9±0.1	8.0±0.2	3.5±0.05	1.75±0.1	4.0±0.1	2.0±0.05	4.0±0.1	$\phi 1.5$ +0.1 -0	0.64±0.1
	RM10	1.6±0.15	2.4±0.2								0.84±0.1
	RM12	2.0±0.15	3.6±0.2								
	RM13	2.8±0.2	3.6±0.2								

8.1.2 2 mm pitch paper :



Packing	Type	A	B	W	F	E	P_1	P_2	P_0	D_0	T
Paper	RM01	0.24±0.05	0.45±0.1	8.0±0.2	3.5±0.05	1.75±0.1	2.0±0.05	2.0±0.05	4.0±0.1	$\phi 1.5$ +0.1 -0	0.40±0.1
	RM02	0.37±0.05	0.67±0.1				2.0±0.05	2.0±0.05			0.37±0.1
	RM04	0.7±0.05	1.2±0.05				2.0±0.1	2.0±0.1			0.45±0.1



Thick Film Chip Resistors
(Lead-Free for RM series standard)
Halogen-Free

Document No.	TRM-XX0S002I
Revise Date	2017/09/04
page number	9/13

8.1.3 4 mm pitch Emboss :

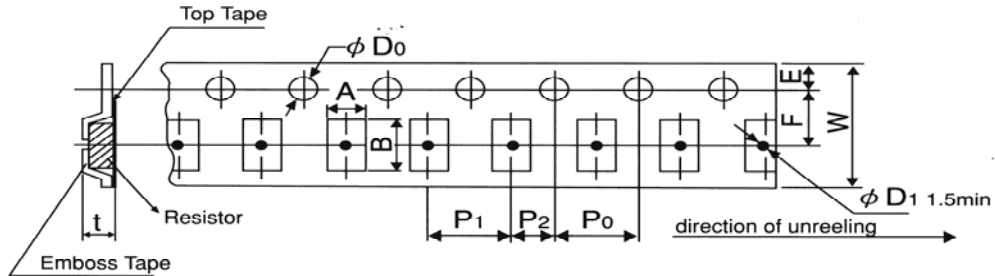

Packing	Type	A	B	W	F	E	P ₁	P ₂	P ₀	D ₀	T
Emboss	RM20	2.8±0.2	5.3±0.2	12.0±0.2	5.5±0.05	1.75±0.1	4.0±0.1	2.0±0.05	4.0±0.05	φ 1.5	0.85±0.15
	RM25	3.6±0.2	6.9±0.2								

UNIT: mm

Package Type / Size		Paper Tape				Emboss Plastic Tape 4 mm pitch
		4 mm pitch		2 mm pitch		
		178mm/R	250mm/R	178mm/R	250mm/R	
RM	01			10000		
RM	02			10000		
RM	04			10000	20000	
RM	06	5000	10000			
RM	10	5000	10000			
RM	12	5000	10000			
RM	13	5000				
RM	20					4000
RM	25					4000



Thick Film Chip Resistors
 (Lead-Free for RM series standard)
Halogen-Free

Document No.	TRM-XX0S002I
Revise Date	2017/09/04
page number	10/13

8.2 Reel Specifications:

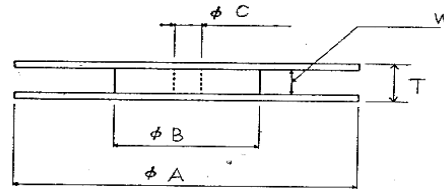

UNIT: mm

Type	ϕA	ϕB	ϕC	W	T
RM01 / 02 / 04 / 06 RM10 / 12 / 13	178.0 ± 2.0	60.0 ± 1.0	13.0 ± 1.0	9.0 ± 1.0	11.5 ± 1.0
RM20 / 25				13.0 ± 1.0	15.5 ± 1.0

8.3. Peel –off force :

Peel –off force of paper and blister tape is in accordance with “JIS-C5202 ”
 that is , 0.1 to 0.7 N at a peel-off speed of 300 mm / minute.





Thick Film Chip Resistors
 (Lead-Free for RM series standard)
Halogen-Free

Document No.	TRM-XX0S002I
Revise Date	2017/09/04
page number	11/13

9. Label :

9.1 Manufacture Label :

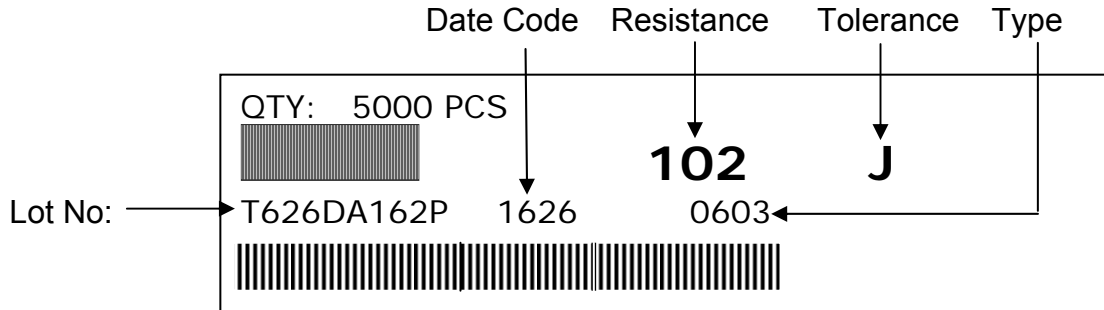

9.2 Customer Label (By customer request):

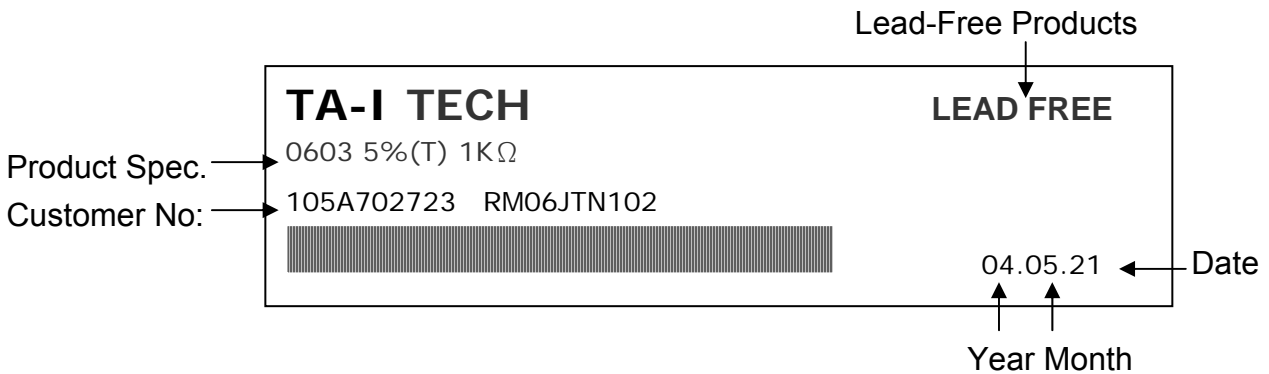

10. Recommended land patterns :

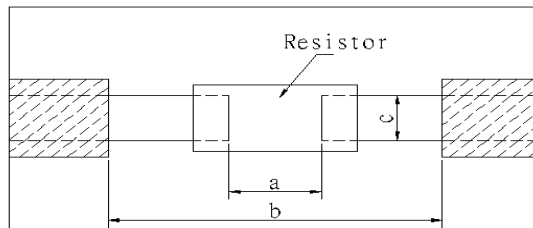

Type	Size	Land pattern		
		Dimension (mm)		
		a	b	c
RM	01 (01005)	0.15~0.20	0.5~0.7	0.20~0.25
RM	02 (0201)	0.25~0.3	0.7~0.9	0.3~0.4
RM	04 (0402)	0.50~0.6	1.4~1.6	0.4~0.6
RM	06 (0603)	0.7~0.9	2.0~2.2	0.8~1.0
RM	10 (0805)	1.0~1.4	3.2~3.8	0.9~1.4
RM	12 (1206)	2.0~2.4	4.4~5.0	1.2~1.8
RM	13 (1210)	2.0~2.4	4.4~5.0	2.3~3.5
RM	20 (2010)	3.3~3.7	5.7~6.5	2.3~3.5
RM	25 (2512)	3.6~4.0	7.6~8.6	2.3~3.5



Thick Film Chip Resistors
(Lead-Free for RM series standard)
Halogen-Free

Document No.	TRM-XX0S002I
Revise Date	2017/09/04
page number	12/13

11. Recommend IR – Reflow profile : (solder : Sn96.5 / Ag3 / Cu0.5)

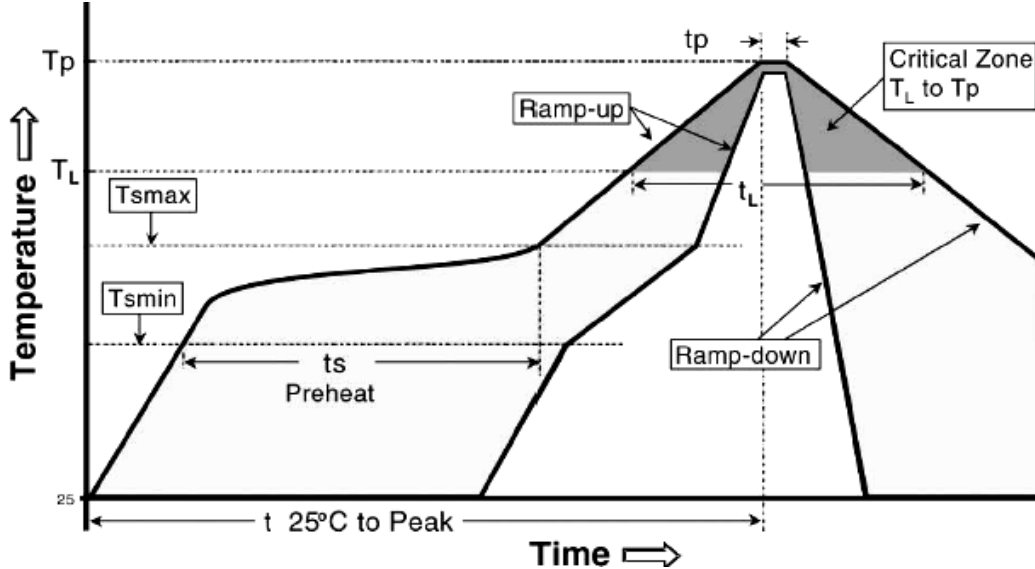

Profile Feature	Lead (Pb)-Free Assembly
Average ramp-up rate (T _{smax} to T _p)	3°C / second max.
Preheat - Temperature Min (T _{smin}) - Temperature Max (T _{smax}) - Time (T _{smin} to T _{smax}) (ts)	150°C 200°C 60 -150 seconds
Time maintained above : - Temperature (T _L) - Time (T _L)	217°C 60-120 seconds
Peak Temperature (T _p)	260°C
Time within $\begin{matrix} +0 \\ -5 \end{matrix}$ °C of actual Peak Temperature (tp) ²	10 seconds
Ramp-down Rate	6°C/second max.
Time 25°C to Peak Temperature	8mimutes max.

Allowed Re-flow times : 3 times

Remark : To avoid discoloration phenomena of chip on terminal electrodes,
 please use N2 Re-flow furnace .

12. Storage Conditions:

Temperature: 5°C~35°C, Humidity:40%~75%

13. Shelf Life:

2 years from manufacturing date.



Thick Film Chip Resistors
(Lead-Free for RM series standard)
Halogen-Free

Document No.	TRM-XX0S002I
Revise Date	2017/09/04
page number	13/13

14. ECN :

Engineering Change Notice: The customer will be informed with ECN if there is significant modification on the characteristics and materials described in Approval Sheet.

15. Manufacturing Country & City :

TA-I TECHNOLOGY CO., LTD. (Taiwan– Tao Yuan)
Tel : 886-3-3246169 Fax : 886-3-3246167

TA-I TECHNOLOGY (SU ZHOU) CO., LTD. (China – Su Zhou)
Tel : 86- 512-63457879 Fax : 86-512-63457869

Associated companies :

(1) FORTUNE TASK RESISTOR FACTORY (China – Dongguan)
Tel : 86-769-8339-4790~3 Fax : 86-769-8339-4794

(2) TA-I TECHNOLOGY ELECTRONIC (DONGGUAN) CO., LTD. (China –Dongguan)
Tel : 86-769-8339-4790~3 Fax : 86-769-8339-4794

(3) TAI OHM ELECTRONICS (M) SDN. BHD. (Malaysia – Penang)
Tel : 604- 3900480 Fax : 604-3901481

(4) P.T.TAI ELECTRONICS Indonesia (Indonesia – Jakarta)
Tel : 62-21-89830123 Fax : 62-21-89830703

X-ON Electronics

Largest Supplier of Electrical and Electronic Components

Click to view similar products for [Thick Film Resistors](#) category:

Click to view products by [TA-I Tech](#) manufacturer:

Other Similar products are found below :

[MCR03EZPFX3162](#) [MCR004YZPJ332](#) [201007J022KT4E](#) [201007F1653T4E](#) [201007F6652T4E](#) [0603WAF137KT5E](#) [RTT204702FTE](#)
[RTT203000FTE](#) [RTT2056R0FTE](#) [CR2010F470KE04Z](#) [RTT018451FTH](#) [RTT021802DTH](#) [0402WGF510LTCE](#) [0201WMJ0200TEE](#)
[TR0603B26K7P0550Z](#) [0201WMF5102TEE](#) [1210W2J047KT5E](#) [YLR12-2-4F-W](#) [HOT\(0.25x1.3\)-3.2-0R-I](#) [HOT\(0.4x1.5\)-5.2-0R-I](#)
[HoT\(0.45x1.5\)-8.2-0R-I](#) [0201WMF1103TEE](#) [0201WMF7152TEE](#) [1210W2J0124T5E](#) [201007J010LT4E](#) [201007J0360T4E](#) [201007J0430T4E](#)
[1206W4F5231T5E](#) [1210W2J0620T5E](#) [201007J0822T4E](#) [0201WMF1005TCE](#) [0201WMF1212TCE](#) [0201WMF1373TCE](#) [0201WMF1400TCE](#)
[0201WMF2000TEE](#) [0201WMF2001TCE](#) [0201WMF226JTCE](#) [0201WMF2672TCE](#) [0201WMF2803TCE](#) [0201WMF357JTCE](#)
[0201WMF3743TCE](#) [0201WMF430JTCE](#) [0201WMF4990TCE](#) [0201WMF5104TCE](#) [0201WMF510JTEE](#) [0201WMF5110TCE](#)
[0201WMF6652TEE](#) [0201WMF6812TCE](#) [0201WMF8200TCE](#) [0201WMF9093TCE](#)