

### Description

The MOSFET provide the best combination of fast switching, low on-resistance and cost-effectiveness.

MOSFET Product Summary		
$V_{DS}(V)$	$R_{DS(on)}(\Omega)$	$I_D(A)$
20	0.2 @ $V_{GS}=4.5V$	$\pm 1$
	0.25 @ $V_{GS}=2.5V$	
	0.31 @ $V_{GS}=1.8V$	

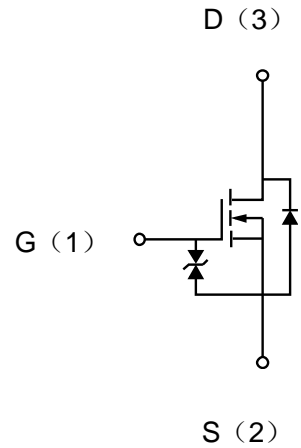

### Absolute maximum rating@25°C

Parameter	Symbol	Value	Units
Drain-Source Voltage	$V_{DS}$	20	V
Gate-Source Voltage	$V_{GS}$	$\pm 8$	V
Continuous Drain Current ( $T_J=150^\circ C$ )	Continuous	$\pm 1$	A
	Pulsed	$\pm 4$	
Total power dissipation	$P_D$	140	mW
Channel temperature	$T_{CH}$	150	$^\circ C$
Range of storage temperature	$T_{STG}$	-55 to +150	$^\circ C$

### Thermal resistance

Parameter	Symbol	Limits	Units
Channel to ambient	$R_{th(ch-a)}$	800	$^\circ C/W$

Electrical characteristics per line@25°C ( unless otherwise specified)

Parameter	Symbol	Conditions	Min.	Typ.	Max.	Units
Drain-Source Breakdown Voltage	$BV_{DSS}$	$I_D=1mA, V_{GS}=0V$	20		-	V
Zero Gate Voltage Drain Current	$I_{DSS}$	$V_{DS}=20V, V_{GS}=0V$	-	-	1	$\mu A$
Gate-Body Leakage Current	$I_{GSS}$	$V_{DS}=0V, V_{GS}=\pm 8V$	-	-	$\pm 10$	$\mu A$
Gate Threshold Voltage	$V_{GS(th)}$	$V_{DS}=10V, I_D=1mA$	0.5	-	1.1	V
Static Drain-Source On-Resistance	$R_{DS(on)}$	$V_{GS}=4.5V, I_D=650mA$	-	0.2	0.25	$\Omega$
		$V_{GS}=2.5V, I_D=450mA$	-	0.25	0.3	$\Omega$
		$V_{GS}=1.8V, I_D=250mA$		0.31	0.45	$\Omega$
Forward transfer admittance	$ Y_{fs} $	$V_{DS}=10V, I_D=300mA$	395			ms
Input Capacitance	$C_{ISS}$	$V_{GS}=0V, V_{DS}=10V,$ $f=1MHz$	-	30		pF
Output Capacitance	$C_{OSS}$		-	13		pF
Reverse Transfer Capacitance	$C_{RSS}$		-	13		pF
Turn-On Delay Time	$t_{d(on)}$	$V_{DD}=10V, V_{GS}=4.0V,$ $R_G=10\Omega, R_L=67\Omega$ $I_D=150mA$	-	7		ns
Turn-Off Delay Time	$t_{d(off)}$		-	23		ns
Turn-On Rise Time	$t_r$		-	15		ns
Turn-On Fall Time	$t_f$		-	15		ns
Drain-Source Diode Forward Voltage	$V_{SD}$	$V_{GS}=0V, I_S=100mA$		-	1.2	V

Typical Characteristics

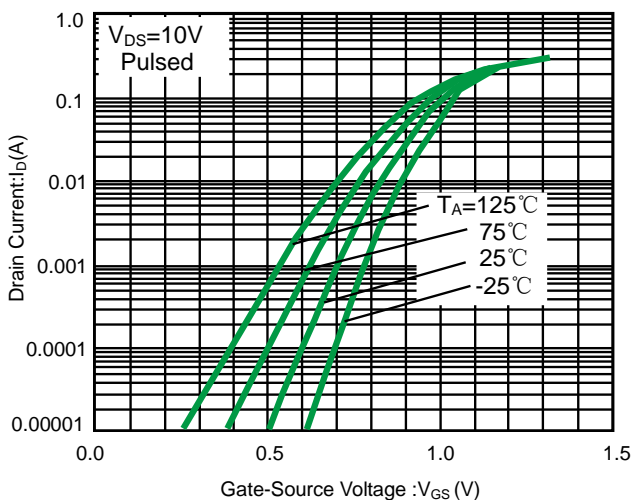

Fig 1. Typical transfer Characteristics

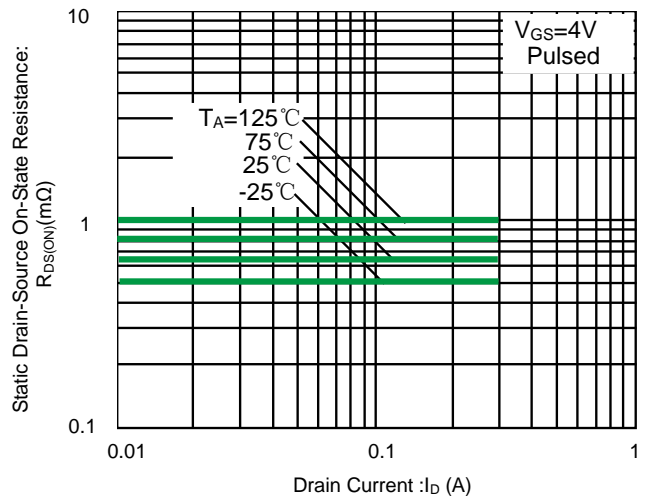

Fig 2. Static drain-source on-state resistance vs. drain current( I )

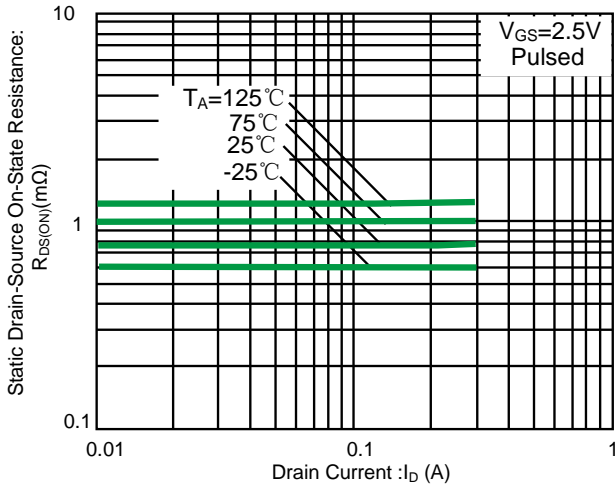

Fig 3. Static drain-source on-state resistance Vs. drain current (II)

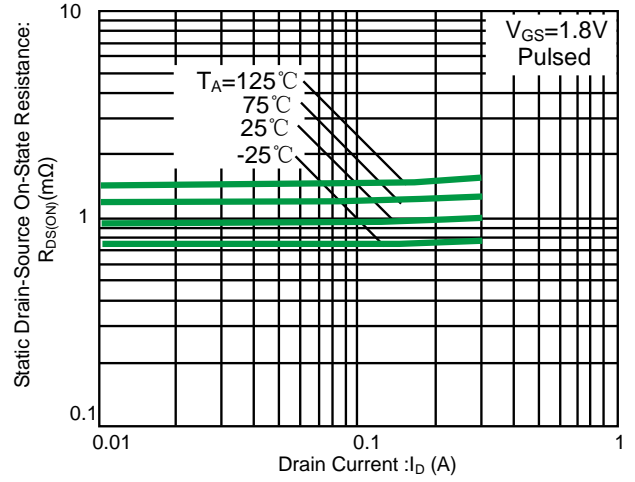

Fig 4. Static drain-source on-state resistance vs. drain current (III)

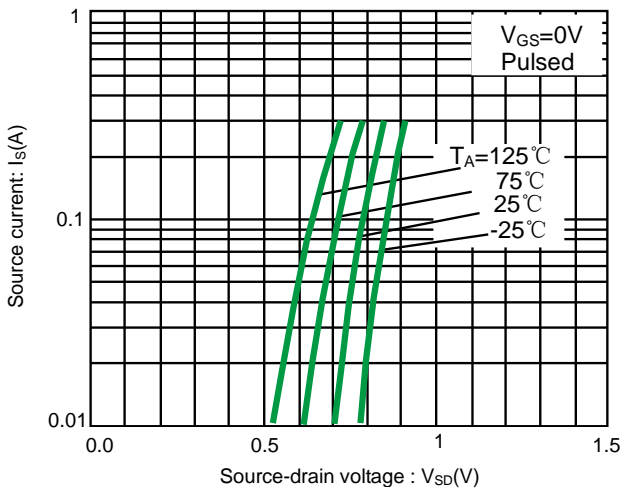

Fig 5. Source current vs. source-drain voltage

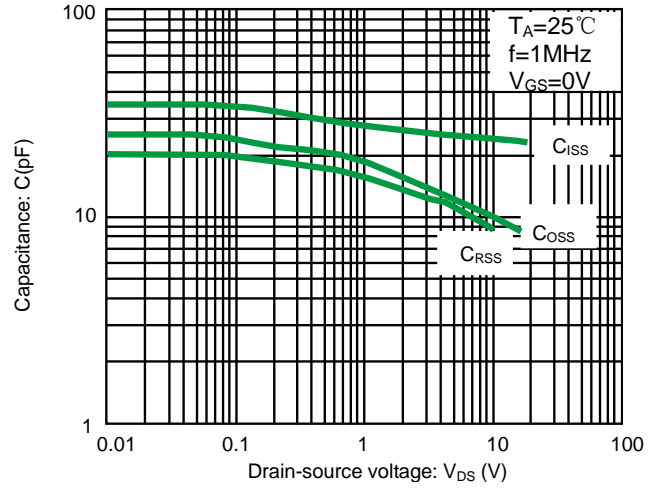

Fig 6. Typical capacitance vs. drain-source voltage

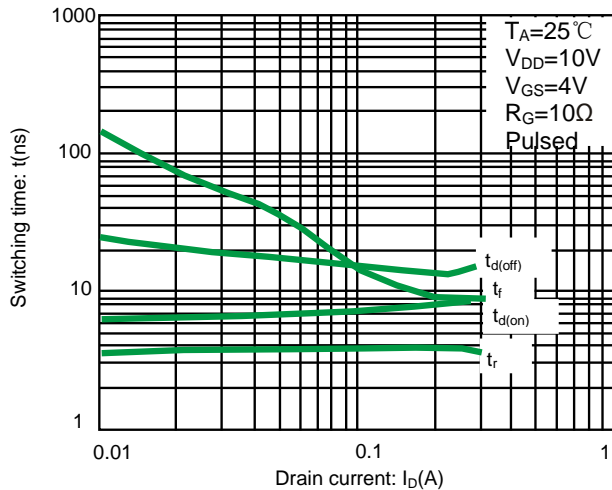

Fig 7. Switching characteristics

Switching characteristics measurement circuit

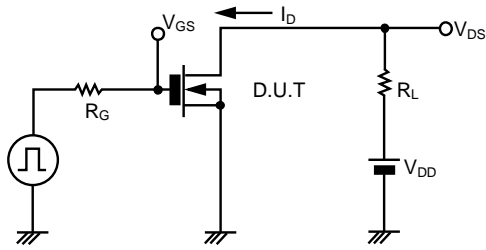

Fig.8 Switching time measurement circuit

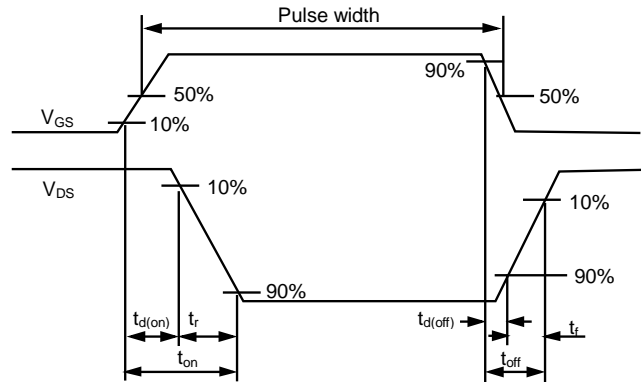
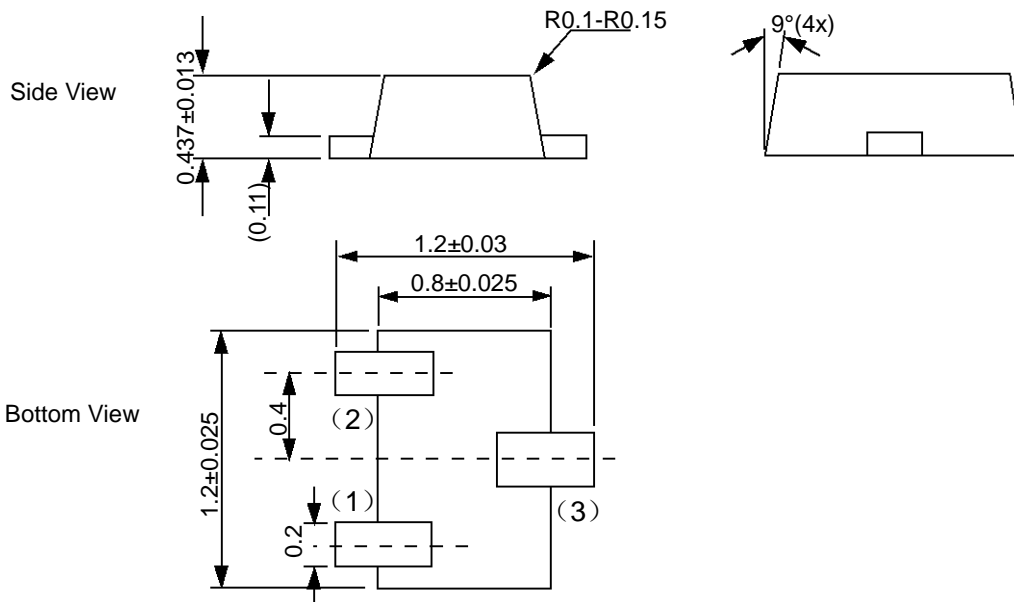
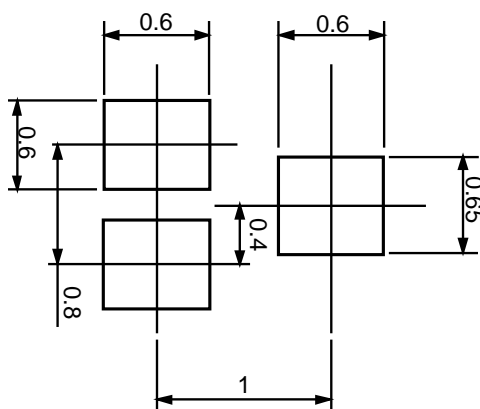

Fig.9 Switching time waveforms

Product dimension (SOT-723)



Unit: mm



Unit: mm

**Ordering information**

Device	Package	Shipping
PNM723T201E0	SOT-723 (Pb-Free)	10000 / Tape & Reel

**IMPORTANT NOTICE**

 and **Prisemi**<sup>®</sup> are registered trademarks of **Prisemi Electronics Co., Ltd (Prisemi)** ,Prisemi reserves the right to make changes without further notice to any products herein. Prisemi makes no warranty, representation or guarantee regarding the suitability of its products for any particular purpose, nor does Prisemi assume any liability arising out of the application or use of any product or circuit, and specifically disclaims any and all liability, including without limitation special, consequential or incidental damages. “Typical” parameters which may be provided in Prisemi data sheets and/or specifications can and do vary in different applications and actual performance may vary over time. All operating parameters, including “Typicals” must be validated for each customer application by customer’s technical experts. Prisemi does not convey any license under its patent rights nor the rights of others. The products listed in this document are designed to be used with ordinary electronic equipment or devices, Should you intend to use these products with equipment or devices which require an extremely high level of reliability and the malfunction of with would directly endanger human life (such as medical instruments, aerospace machinery, nuclear-reactor controllers, fuel controllers and other safety devices), please be sure to consult with our sales representative in advance.

Website: <http://www.prisemi.com>

For additional information, please contact your local Sales Representative.

©Copyright 2009, Prisemi Electronics

 **Prisemi**<sup>®</sup> is a registered trademark of Prisemi Electronics.

All rights are reserved.

## X-ON Electronics

Largest Supplier of Electrical and Electronic Components

*Click to view similar products for [MOSFET](#) category:*

*Click to view products by [Prisemi](#) manufacturer:*

Other Similar products are found below :

[614233C](#) [648584F](#) [MCH3443-TL-E](#) [MCH6422-TL-E](#) [FDPF9N50NZ](#) [FW216A-TL-2W](#) [FW231A-TL-E](#) [APT5010JVR](#) [NTNS3A92PZT5G](#)  
[IRF100S201](#) [JANTX2N5237](#) [2SK2464-TL-E](#) [2SK3818-DL-E](#) [FCA20N60\\_F109](#) [FDZ595PZ](#) [STD6600NT4G](#) [FSS804-TL-E](#) [2SJ277-DL-E](#)  
[2SK1691-DL-E](#) [2SK2545\(Q,T\)](#) [405094E](#) [423220D](#) [MCH6646-TL-E](#) [TPCC8103,L1Q\(CM](#) [367-8430-0972-503](#) [VN1206L](#) [424134F](#)  
[026935X](#) [051075F](#) [SBVS138LT1G](#) [614234A](#) [715780A](#) [NTNS3166NZT5G](#) [751625C](#) [873612G](#) [IRF7380TRHR](#) [IPS70R2K0CEAKMA1](#)  
[RJK60S3DPP-E0#T2](#) [RJK60S5DPK-M0#T0](#) [APT5010JVFR](#) [APT12031JFLL](#) [APT12040JVR](#) [DMN3404LQ-7](#) [NTE6400](#) [JANTX2N6796U](#)  
[JANTX2N6784U](#) [JANTXV2N5416U4](#) [SQM110N05-06L-GE3](#) [SIHF35N60E-GE3](#) [2SK2614\(TE16L1,Q\)](#)