



湖南艾华集团股份有限公司

HUNAN AIHUA GROUP CO., LTD

Tel: (0737)6184466 Fax : (0737)6180493

[Http://www.aihuaglobal.com](http://www.aihuaglobal.com)

Customer: 深圳市仁天芯科技有限公司

Date: February 5, 2018

SPECIFICATION

Description: Aluminum Electrolytic Capacitors

AISHI P/N: EWH2DS471M35OT

SERIES: WH

ITEM: 200V470 μ F (Φ 18 \times 35)

Customer P/N:

No.: CRS-JG-1802017A

APPROVED BY

Please Return One Copy with Your Approval
承认后请寄回一份

PREPARED BY	CHECKED BY	APPROVED BY
 <p>李婷 技术中心</p>	 <p>许雷冰 技术中心</p>	 <p>黄远彬 技术中心</p>

<i>Starts</i>	<i>File Description</i>	<i>Component</i>	<i>No./rev</i>
Released	Approval Sheet-WH	CRS-2010-WH/ 01	

变更记录

版本	更改原因	更改内容	生效日期
CRS-JG-1802017	新建	新建	2018-2-2
CRS-JG-1802017A		修改容差范围	2018-2-5

Name	Approval Sheet-WH				
File No.	WH	Version	01	Page	2
STANDARD MANUAL					

HUNAN AIHUA GROUP

ALUMINIUM
ELECTROLYTIC
CAPACITOR

Customer	深圳市仁天芯科技有限公司	SERIES	WH	DA
-----------------	--------------	---------------	----	-----------

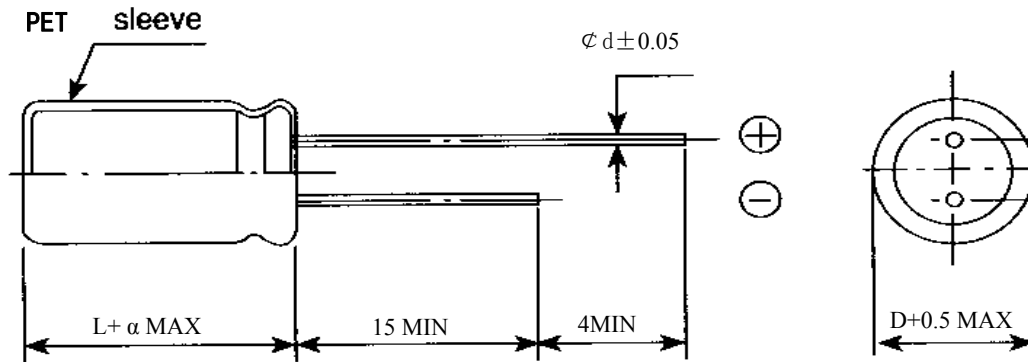

FIG-1

TABLE-1

No.	Customer Part No.	Aishi Part No.	Capacitance (μF)	Tolerance on Rated Capacitance (%)	Rated Voltage (Vdc)	Surge Voltage (Vdc)	Operating Temp. Range (°C)	tanδ (120Hz) (Max)	Leakage Current (μ A) (5min.)	Max Ripple Current (mArms) at 105°C 120Hz
1		EWH2DS471M350T	470	-30~0	200	250	-25~+105	0.2	1905	800

Starts	File Description	Component	No./rev
Released	Approval Sheet-WH	CRS-2010-WH/ 01	

1 概述 SCOPE

本承认书规定了 WH 系列径向引线引出铝电解电容器的技术规范，本技术规范条文解释权归本公司所有。

This specification covers “WH series” miniature single-ended aluminum electrolytic capacitors, Aishi reserves the right of final interpretation for this technical specification.

2 参考标准 APPLICABLE SPECIFICATION

本承认书参考 JIS-C-5101-1 和 JIS-C-5101-4 制定。

This approval sheet consulted the institute of JIS-C-5101-1 and JIS-C-5101-4.

3 工作温度范围 OPERATING TEMPERATURE RANGE

工作温度范围是电容器在施加额定工作电压条件下，可以长期可靠工作的环境温度范围。

-40°C~+105°C (6.3V.DC~100V.DC) -25°C~+105°C (160V.DC~450V.DC)

Operating temperature range is the range of ambient temperature at which the capacitor can be operated continuously at rated voltage.

-40°C~+105°C (6.3V.DC~100V.DC) -25°C~+105°C (160V.DC~450V.DC)

4 测试环境 CONDITION OF TEST

如果没有其他规定，标准的测试、检验环境条件如下所示：

环境温度：15°C~35°C

相对湿度：45%~75%

大气压力：86kPa~106kPa

如果对测试结果有异议，可以在以下条件测试：

环境温度：20±2°C

相对湿度：60%~67%

大气压力：86kPa~106kPa

Unless otherwise specified, the standard range of atmospheric conditions for making measurements and tests are as follows

Ambient temperature : 15°C to 35°C

Relative humidity : 45% to 75%

Air pressure : 86kPa to 106kPa

If there may be doubt on the results, measurements shall be made within the following limits

Ambient temperature : 20±2°C

Relative humidity : 60% to 67%

Air pressure : 86kPa to 106kPa

Name	Approval Sheet-WH				
File No.	WH	Version	01	Page	1
STANDARD MANUAL					

Starts	File Description	Component No./rev
Released	Approval Sheet-WH	CRS-2010-WH/ 01

5 产品特性 PRODUCT CHARACTERISTICS

5.1 电气特性 ELECTRICAL CHARACTERISTICS

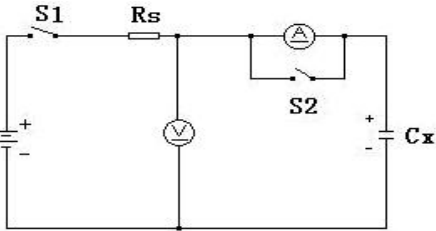
序号 No.	项目 Item	测试方法 Test method	性能 Performance
5.1.1	额定工作电压 Rated voltage	电压：直流电压值+交流电压峰值≤额定电压 . Voltage: DC. Voltage + peak ripple voltage ≤ Rated voltage	6.3V.DC~450V.DC
5.1.2	电容量 Capacitance	测试频率：120Hz(±20%) 测试电路：串联等效 测试电压：0.5Vrms 以下+1.5~2.0VDC Measuring frequency: 120Hz±20% Measuring circuit: Series equivalent circuit Measuring voltage: 0.5Vrms or less +1.5 to 2.0 VDC	容量偏差：-30%~+0 Capacitance tolerance: -30%~+0
5.1.3	损失角正切值 Dissipation Factor	测试条件与 5.1.2 电容量测试相同 Testing condition are the same as 5.1.2 for capacitance	DF 不大于规定值 DF: Not more than the specified value.
5.1.4	漏电流 Leakage current	在电容器两端施加额定工作电压，并串联 1000 ±100Ω 电阻，在施加规定时间电压后，测量漏 电流。 测试电路如下图： The rated voltage shall be applied across the capacitor and its protective resistor which shall be 1000±100Ω. The leakage current shall then be measured after an electrification period of schedule time.  Rs: Protective resistor(1000±100Ω) DC ammeter DC voltmeter S ₁ : Switch S ₂ : Protective switch for an ammeter	6.3V~100V: I≤0.01CV 或 3μA, 取较大值 (2 分钟后) 160V~450V: CV≤1000 I≤0.03CV+15μA, CV>1000 I≤0.02CV+25μA (5 分钟后) 6.3V~100V: I≤0.01CV or 3μA Whichever is greater (after 2 min) 160V~450V: CV≤1000 I≤0.03CV+15μA, CV>1000 I≤0.02CV+25μA (after 5 min) I: 漏电流 (μA) C: 容量 (μF) V: 额定工作电压 (V) I: Leakage current(μA) C: Capacitance(μF) V: Rated voltage (V)

Name	Approval Sheet-WH				
File No.	WH	Version	01	Page	2
STANDARD MANUAL					

Starts Released	File Description Approval Sheet-WH	Component No./rev CRS-2010-WH/ 01
--------------------	---------------------------------------	--------------------------------------

5.1.5	温度特性 Temperature Characteristic	<table border="1" style="margin-bottom: 10px;"> <thead> <tr> <th>阶段</th> <th>温度</th> <th>时间</th> </tr> </thead> <tbody> <tr> <td style="text-align: center;">1</td> <td style="text-align: center;">$20 \pm 2^{\circ}\text{C}$</td> <td style="text-align: center;">--</td> </tr> <tr> <td style="text-align: center;">2</td> <td style="text-align: center;">$-25, -40_{-3}^{+0}\text{C}$</td> <td style="text-align: center;">2h</td> </tr> <tr> <td style="text-align: center;">3</td> <td style="text-align: center;">$20 \pm 2^{\circ}\text{C}$</td> <td style="text-align: center;">15min.</td> </tr> <tr> <td style="text-align: center;">4</td> <td style="text-align: center;">105_{-0}^{+3}C</td> <td style="text-align: center;">2h</td> </tr> </tbody> </table> <p>阶段 1: 测量容量和阻抗 (z 20°C $120\text{Hz} \pm 20\%$) 阶段 2: 电容器恒温贮存 2 小时, 在热平衡状态测阻抗 (z-25, -40°C $120\text{Hz} \pm 20\%$) 阶段 4: 电容器恒温贮存 2 小时, 在热平衡状态测电容量 Step 1:Capacitance and impedance shall be measured. (z 20°C $120\text{Hz} \pm 20\%$) Step 2:After the capacitor being stored for 2 hours, impedance shall be measured at thermal stability. (z-25, -40°C $120\text{Hz} \pm 20\%$) Step 4:After the capacitor being stored for 105°C 2 hours, capacitance shall be measured. The measurement shall be made at thermal stability</p>	阶段	温度	时间	1	$20 \pm 2^{\circ}\text{C}$	--	2	$-25, -40_{-3}^{+0}\text{C}$	2h	3	$20 \pm 2^{\circ}\text{C}$	15min.	4	105_{-0}^{+3}C	2h	<p>阶段 2: 阻抗值与阶段 1 阻抗值相比, 不大于表 2 要求。 阶段 4: 容量变化应在初值的 $\pm 20\%$ 范围内 Step 2: Impedance value ratio to the value at step 1 shall be not more than the value given table-2 Step 4: Variation of capacitance Within $\pm 20\%$ of the initial value.</p>
阶段	温度	时间																
1	$20 \pm 2^{\circ}\text{C}$	--																
2	$-25, -40_{-3}^{+0}\text{C}$	2h																
3	$20 \pm 2^{\circ}\text{C}$	15min.																
4	105_{-0}^{+3}C	2h																

5.1.6	耐浪涌电压 Surge Test	<p>施加表 1 所列浪涌电压, 充电 30 ± 5 秒, 放电 5.5 ± 0.5 分钟作为一个周期, 共进行 1000 次。 测试温度: $15^{\circ}\text{C} - 35^{\circ}\text{C}$ 然后在标准大气条件下放置达到热稳定, 测试各参数 Application of DC surge Voltage stated at table-1, 1000 times of charging for 30 ± 5 sec., discharging with a period of 5.5 ± 0.5 min.. Test temperature: $15^{\circ}\text{C} - 35^{\circ}\text{C}$ And the capacitor shall be stored under standard atmospheric conditions to obtain thermal stability, after which measurements shall be made.</p>	<p>容量变化: 在初始值的 $\pm 20\%$ 以内。 损耗角正切值不大于规定值的 200%。 漏电流: 达到 5.1.4 要求 Capacitance change: Within $\pm 20\%$ of the initial value Dissipation factor: Not more than 200% of the specified value. Leakage current: To satisfy No. 5.1.4</p>
-------	---------------------	---	--

Test circuit

Note: This requirement is applicable only to instantaneous over voltage which may be applied to terminals of capacitor, therefore, not applicable to such over voltages as often applied.

Name	Approval Sheet-WH				
File No.	WH	Version	01	Page	3
STANDARD MANUAL					

Starts	File Description	Component No./rev
Released	Approval Sheet-WH	CRS-2010-WH/ 01

5.2 机械特性 MECHANICAL PERFORMANCE

序号 No.	项目 Item	测试方法 Test method	特性 Performance																								
5.2.1	端子强度 Terminal Strength	<p>端子抗拉强度： 沿电容器端子引线方向施加拉力(如下表)，10±1 秒。</p> <table border="1" style="margin-left: 20px;"> <tr> <td style="text-align: center;">引线直径Φ</td> <td style="text-align: center;">0.45</td> <td style="text-align: center;">0.5</td> <td style="text-align: center;">0.6</td> <td style="text-align: center;">0.8</td> <td style="text-align: center;">1.0</td> </tr> <tr> <td style="text-align: center;">拉力 N</td> <td colspan="2" style="text-align: center;">5</td> <td colspan="2" style="text-align: center;">10</td> <td style="text-align: center;">20</td> </tr> </table> <p>端子抗弯强度： 在电容器引线施加固定重力（如下表），然后，将电容器弯折 90° 后回到原位，再向相反方向弯折 90° 后回到原位。 上述过程在 5 秒内完成。</p> <table border="1" style="margin-left: 20px;"> <tr> <td style="text-align: center;">引线直径Φ</td> <td style="text-align: center;">0.45</td> <td style="text-align: center;">0.5</td> <td style="text-align: center;">0.6</td> <td style="text-align: center;">0.8</td> <td style="text-align: center;">1.0</td> </tr> <tr> <td style="text-align: center;">拉力 N</td> <td colspan="2" style="text-align: center;">2.5</td> <td colspan="2" style="text-align: center;">5</td> <td style="text-align: center;">10</td> </tr> </table> <p>Tensile strength of termination: A static load (stated in the table below) shall be applied to the terminal in the axial direction and acting in a direction away from the body for 10±1 sec.. Bending strength of termination: Hang the specified dead weight (stated in the table below) , then bent the body through 90° , return to the original position. Next bent it in opposite direction through 90° with the same speed, again return to the original position. Carry out this operation in about 5 sec.</p>	引线直径Φ	0.45	0.5	0.6	0.8	1.0	拉力 N	5		10		20	引线直径Φ	0.45	0.5	0.6	0.8	1.0	拉力 N	2.5		5		10	<p>测量电容器应无接触不良、开路或短路，无可见机械损伤 When the capacitor is measured, there shall be no intermittent contacts, or open or short-circuiting. There shall be no such mechanical damage.</p>
引线直径Φ	0.45	0.5	0.6	0.8	1.0																						
拉力 N	5		10		20																						
引线直径Φ	0.45	0.5	0.6	0.8	1.0																						
拉力 N	2.5		5		10																						
5.2.2	振动试验 Resistance to Vibration	<p>依据 JIS C 5101-1 4.17 试验。 在 3 个互相垂直的方向分别施加 2 小时振动，共 6 小时 频率：10-55Hz 振幅：1.5mm. 振速：1 分钟内振速 10~55~10Hz To comply with JIS C 5101-1 4.17 Direction and duration of vibration: 3 orthogonal directions mutually each for 2h , Total 6h. Vibration Frequency Range :10-55Hz Peak to peak amplitude: 1.5mm Sweep rate :10to55to10Hz in about 1 min.</p>	<p>测量电容器应无接触不良开路或短路，无可见机械损伤。 When the capacitor is measured there shall be no intermittent contacts, or open or short circuiting There shall be no such mechanical damage.</p>																								
5.2.3	可焊性 Solderability	<p>依据 JIS C 5101-1 4.15 进行试验 焊锡温度：235±5℃ 浸入时间：2±0.5 秒 To comply with JIS C 5101-1 4.15 Temperature of solder: 235±5℃ Dipping time: 2±0.5sec. This specification shall be met after the capacitors are stored under standard atmospheric conditions for 6 months.</p>	<p>浸入焊锡的引线表面积约 90%以上应附着新锡 At least 90% of circumferential surface of the dipping portion of termination shall be covered with new solder.</p>																								

Name	Approval Sheet-WH				
File No.	WH	Version	01	Page	4
STANDARD MANUAL					

<i>Starts</i>	<i>File Description</i>	<i>Component No./rev</i>
Released	Approval Sheet-WH	CRS-2010-WH/ 01

5.3 耐久性测试 ENDURANCE PERFORMANCE

序号 No.	项目 Item	测试方法 Test method	特性 Performance
5.3.1	耐焊接热 Resistance to soldering heat	焊槽法： 焊锡温度：260±5℃ 浸入时间：10±1 秒 电路板：1.6mm Solder bath method Solder bath temperature：260±5℃ Immersion time：10±1sec. Printed wiring board: 1.6mm	容量变化：在初始值±10%范围内 损失角正切值：不大于规定值 漏电流：满足 5.1.4 要求 外观：无异状 Variation of capacitance: Within ±10% of the initial value Dissipation factor: Not more than the specified value Leakage current: To satisfy No.5.1.4 Appearance: No remarkable abnormality.
5.3.2	稳态湿热 Resistance to damp heat (steady state)	依据 JIS C 5101-1 4.22 进行试验 试验温度：40±2℃ 试验时间：240±8h 相对湿度：90~95% 试验后，电容器在标准大气条件下 1~2 小时， 然后测试参数 To comply with JIS C 5101-1 4.22 Test temperature：40±2℃ Test time：240±8h Relative humidity: 90~95% After completion of test, the capacitor shall be subjected to standard atmospheric conditions for 1 to 2 hours, after which measurements shall be made.	容量变化：在初始值±10%范围内 损失角正切值：不大于规定值 漏电流：满足 5.1.4 要求 外观：无异状 Variation of capacitance: Within ±10% of the initial value. Dissipation factor: Not more than the specified value Leakage current: To satisfy No.5.1.4 Appearance: No remarkable abnormality.
5.3.3	高温负荷试验 Load Life Test	1. 试验温度：105±2℃, 施加额定电压和额定 纹波电流 Application of the rated voltage and the rated ripple current, Test temperature: 105±2℃ 试验时间：2000 ⁺⁷² ₋₀ h Test time: 2000 ⁺⁷² ₋₀ h	容量变化：在初始值±20%范围内 损耗角正切值：不超过规定值的 200% 漏电流：不大于规定值 外观：无异状 Variation of capacitance: Within ±20% of the initial value. Dissipation factor: Not more than 200% of the specified value Leakage current: Not more than the specified value Appearance: No remarkable abnormality.

Name	Approval Sheet-WH				
File No.	WH	Version	01	Page	5
STANDARD MANUAL					

Starts		File	Description	Component	No./rev
Released		Approval Sheet-WH		CRS-2010-WH/ 01	
5.3.4	高温贮存试验 Shelf Life Test	<p>在 $105 \pm 2^\circ\text{C}$ 环境下无负荷贮存 1000^{+48}_{-0} h, 至少恢复 16 小时后。</p> <p>The capacitors are then stored with no voltage applied at a temperature of $105 \pm 2^\circ\text{C}$ for 1000^{+48}_{-0} h and then resumed 16 hours.</p>		<p>容量变化: 初始值 $\pm 20\%$ 范围内。 损耗角正切值: 不超过规定值的 200% 漏电流: 不超过规定值的 200% 外观: 无异状</p> <p>Variation of capacitance: Within $\pm 20\%$ of the value before test. Dissipation factor: Not more than 200% of the specified value Leakage current: Not more than 200% of the specified value Appearance: No remarkable abnormality.</p>	
5.3.5	防爆试验 Safety Vent	<p>在电容器两极施加反向直流电压, 其中通过的电流为 1 A, 在测试时防爆装置应能在 30 分钟内动作。</p> <p>D. C. Application test The capacitor shall be subjected to a reverse D.C. voltage. The current flowing through the capacitor shall be 1A. If the vent does operate with the voltage applied for 30 minutes, the test is considered to be passed.</p>		<p>上述过程中应无引线、铝箔等散射, 无火花产生。</p> <p>The vent device is actuated under the test conditions, thereby preventing terminals, metal pieces, etc, of the capacitor from scattering due to burst, the case from separating from the seal packing, or the capacitor from producing flame.</p>	

※ 表 2 (TABLE 2)

阻抗比 Max. Impedance Ratio	额定工作电压	6.3	10	16	25	35	50	63	100	160	200	250	350	400	450
	Rated voltage (v)	5	4	3	2			3			6		6		
	$ z _{-25^\circ\text{C}}/ z _{20^\circ\text{C}}$	12	10	8	5	4	3			-		-	-		
	$ z _{-40^\circ\text{C}}/ z _{20^\circ\text{C}}$	12	10	8	5	4	3			-		-	-		

Name	Approval Sheet-WH				
File No.	WH	Version	01	Page	6
STANDARD MANUAL					

Starts	File Description	Component	No./rev
Released	Approval Sheet-WH	CRS-2010-WH/ 01	

6 标记 MARKING

6.1 在电容器体上应注明如下内容:

(1) 生产厂商商标



(2) 型号-额定温度

WH 105°C

(3) 周期代码-我司代码-套管材质

YyWw□PET (Yy 表示年份, Ww 表示制造周期,

□表示我司代码, 我司代码: “Z、Y、J、S……”

PET 表示套管材质)

(4) 电压容量

--V-- μ F

(5) 负极标志



6.1 The following items shall be marked indelibly on the capacitor.

(1) Manufacture's name or trade mark.



(2) Model - Rated temperature

WH 105°C

(3) Cycle code-AIHUA code -Sleeve material

YyWw□ PET (Yy denotes last two digit of years and Ww

denotes the week in which the capacitor is

Manufactured, □denotes the code of AIHUA, AIHUA code:

“Z、Y、J、S……” PET denotes the sleeve material)

(4) Voltage Capacity

--V-- μ F

(5) Polarity of the terminals



6.2 标记颜色 Marking color

套管颜色: 黑色

标记颜色: 白

Sleeve color: Black

Marking color: White

7 纹波电流频率因子 RIPPLE CURRENT FREQUENCY COEFFICIENT

Freq. (Hz)	50	120	300	1k	10k	100k
Cap < 10	0.65	1.00	1.35	1.75	2.30	2.50
10 ≤ Cap < 100	0.75	1.00	1.25	1.50	1.75	1.80
100 ≤ Cap ≤ 1000	0.80	1.00	1.15	1.30	1.40	1.50
Cap > 1000	0.85	1.00	1.03	1.05	1.08	1.08

Name	Approval Sheet-WH				
File No.	WH	Version	01	Page	7
STANDARD MANUAL					

Starts	File Description	Component	No./rev
Released	Approval Sheet-WH	CRS-2010-WH/ 01	

8 物料编码 PART NO SYSTEM

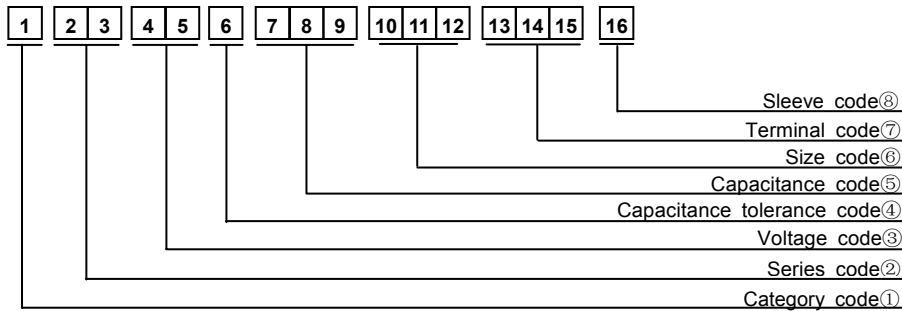

①Category code

Type	Code
	1th
Electrolytic Capacitor	E

②Series code

Series name	Code	
	2 th	3 th
WH	W	H

③Voltage code

WV(V)	Code	
	4th	5th
4	0	G
6.3	0	J
10	1	A
16	1	C
25	1	E
35	1	V
40	1	G
50	1	H
63	1	J
80	1	B
100	1	K
160	2	C
180	2	L
200	2	D
220	2	N
250	2	E
315	2	F
350	2	V
380	2	P
400	2	G
420	2	T
450	2	W
500	2	H

④Capacitance Tolerance code

Tol. (%)	Code
	6th
-10~+10	K
-20~+20	M
-10~+30	Q
-10~+50	T
-10~+20	V
0~+20	A
-5~+20	C
-10~-20	B
-5~+5	D
-0~+10	E
-5~-20	F
-15~+5	N

⑤Capacitance code

Cap (μF)	Code		
	7th	8th	9th
0.10	R	1	0
0.22	R	2	2
0.33	R	3	3
0.47	R	4	7
0.68	R	6	8
1	0	1	0
2.2	2	R	2
3.3	3	R	3
4.7	4	R	7
6.8	6	R	8
10	1	0	0
22	2	2	0
33	3	3	0
47	4	7	0
68	6	8	0
100	1	0	1
220	2	2	1
330	3	3	1
470	4	7	1
680	6	8	1
1000	1	0	2
2200	2	2	2
3300	3	3	2
4700	4	7	2
6800	6	8	2
10000	1	0	3
22000	2	2	3
33000	3	3	3
68000	6	8	3

⑥Size code

ΦD	Code
	10th
4	C
5	D
6.3	E
8	F
10	G
11	H
12	J
12.5	W
13	K
14	X
16	L
18	M
19	Z
20	N
22	O
25	P
30	Q
35	R
40	Y
51	S
63.5	T
76	U
89	V

L	Code	
	11th	12th
5	0	5
7	0	7
11	1	1
12	1	2
16	1	6
20	2	0
25	2	5
30	3	0
35	3	5
40	4	0
46	4	6
50	5	0
60	6	0
80	8	0
100	A	0
115	B	5
120	C	0
130	D	0
140	E	0
160	G	0
200	K	0

⑦Terminal Code

Specification	Code		
	13th	14th	15th
Bulk packing	O	-	-
编带 Taping F=5mm (4Φ~8Φ)	P	5	0
Taping F=2.5mm (4Φ~5Φ)	X	2	5
Taped Straight-pack	B	5	0
		3	5
		2	5
		2	0
Lead Cut L=3.5mm	C	3	5
Lead Cut L=11.0mm	C	B	0
Lead Forming & cut L=4.5mm	F	4	5
Kink & cut L=4.5mm	J	4	5

⑧Sleeve Code

Sleeve	Code
	16th
PVC	C
PET	T

Name	Approval Sheet-WH				
File No.	WH	Version	01	Page	8
STANDARD MANUAL					

Starts	File Description	Component	No./rev
Released	Approval Sheet-WH	CRS-2010-WH/01	

9 加工型式 Lead Forming Type

9.1 编带 Taping

● Straight lead

PIN Code : X

ΦD=4~5

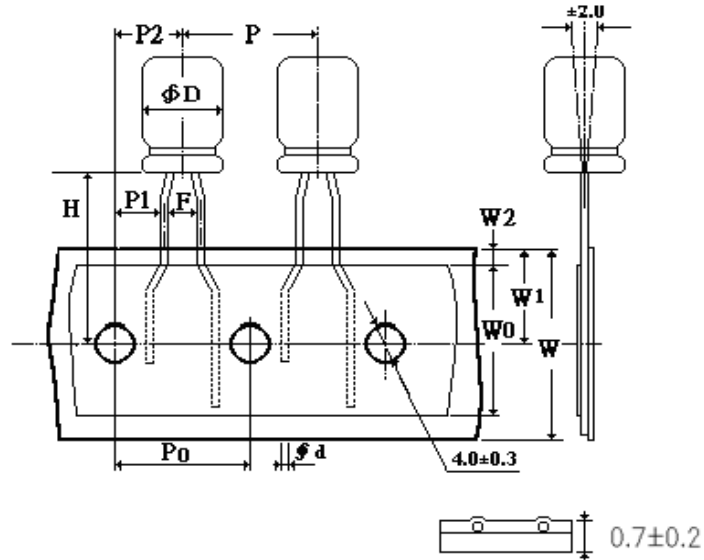

PIN Code : B

ΦD=4~8

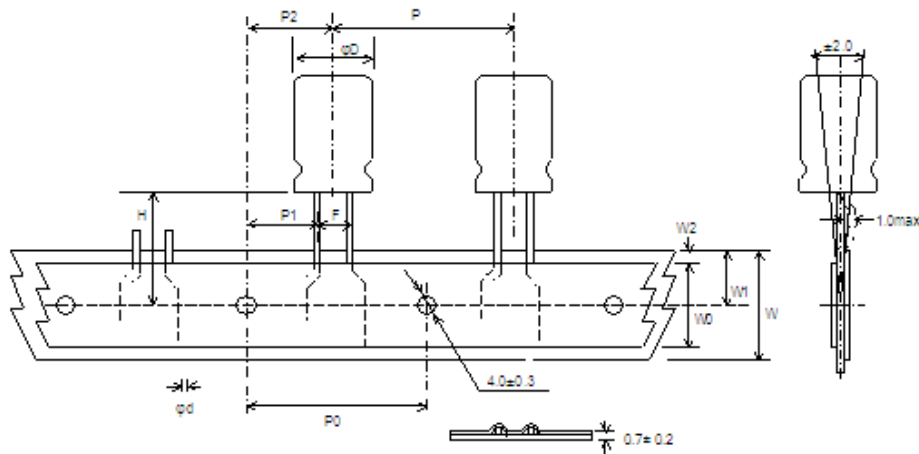

Name	Approval Sheet-WH					
File No.	WH	Version	01	Page	9	
STANDARD MANUAL						

Starts	File Description	Component	No./rev
Released	Approval Sheet-WH	CRS-2010-WH/ 01	

PIN Code : B
ΦD=10

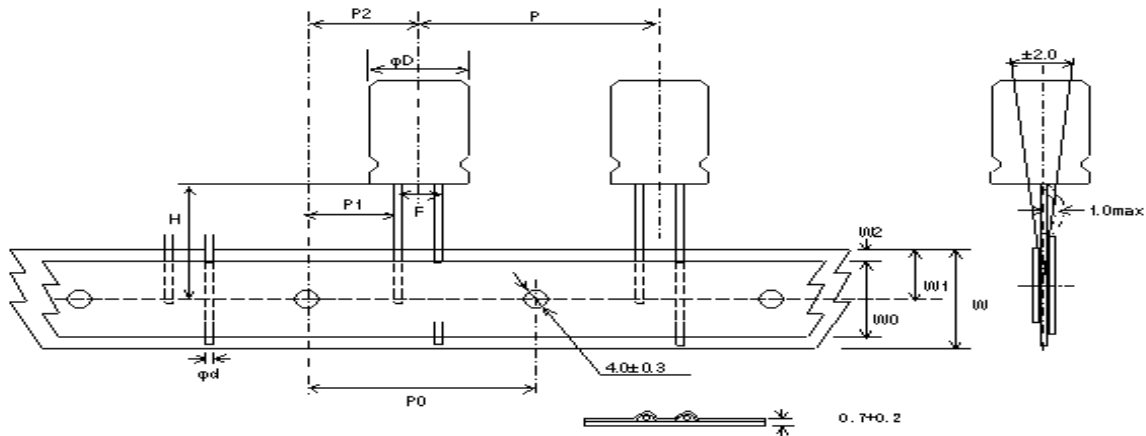

DIMENSIONS(mm)

Items	Symbol	CASE SIZE										Tolerance			
		4x5 4x7		5x5 5x7		5x11		6.3x 5	6.3x7	6.3x11	8x5 8x7 8x11 8x12		8x16 8x20	10x13 10x16 10x20	
Pin Code		X	B	X	B	X	B	B	B	B	B	B	B		
Lead wire diameter	Φd	0.45		0.45		0.5		0.45	0.5	0.5	0.45/0.5		0.5/0.6	0.6	±0.05
Pitch of body	P	12.7		12.7		12.7		12.7	12.7	12.7	12.7		12.7	12.7	±1.0
Feed hole pitch	P0	12.7		12.7		12.7		12.7	12.7	12.7	12.7		12.7	12.7	±0.2
Hole center to lead distance	P1	5.1	5.6	5.1	5.35	5.1	5.35	5.1	5.1	5.1	4.6	4.6	3.85		±0.7
Feed hole center to body center distance	P2	6.35		6.35		6.35		6.35	6.35	6.35	6.35		6.35	6.35	±1.0
Lead to lead distance	F	2.5	1.5	2.5	2.0	2.5	2.0	2.5	2.5	2.5	3.5	3.5	5.0		±0.5
Height of body from tape center	H	18.5		18.5		18.5		18.5	18.5	18.5	18.5		18.5	18.5	±0.75
Base tape width	W	18.0		18.0		18.0		18.0	18.0	18.0	18.0		18.0	18.0	±0.5
Adhesive tape width	W0	11.0		11.0		11.0		11.0	11.0	11.0	11.0		11.0	11.0	min
Hole position	W1	9.0		9.0		9.0		9.0	9.0	9.0	9.0		9.0	9.0	+0.75 -0.5
Hole down tape position	W2	3.0		3.0		3.0		3.0	3.0	3.0	3.0		3.0	3.0	max

Name	Approval Sheet-WH					
File No.	WH	Version	01	Page	10	
STANDARD MANUAL						

Starts Released	File Description Approval Sheet-WH	Component CRS-2010-WH/ 01	No./rev
--------------------	---------------------------------------	------------------------------	---------

● Forming type

PIN Code : P

ΦD=4~8

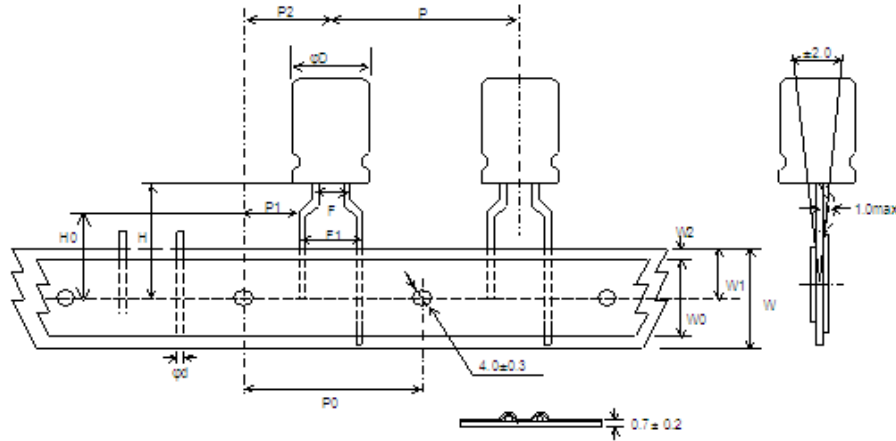

DIMENSIONS(mm)

Items	Symbol	CASE SIZE									Tolerance
		4x5 4x7	5x5	5x7	5x11	6.3x5	6.3x7	6.3x11	8x5 8x7 8x11 8x12	8x16 8x20	
Pin Code		P	P	P	P	P	P	P	P	P	
Lead wire diameter	Φd	0.45	0.45	0.45	0.5	0.45	0.5	0.5	0.45/0.5	0.5/0.6	±0.05
Pitch of body	P	12.7	12.7	12.7	12.7	12.7	12.7	12.7	12.7	12.7	±1.0
Feed hole pitch	P0	12.7	12.7	12.7	12.7	12.7	12.7	12.7	12.7	12.7	±0.2
Hole center to lead distance	P1	3.85	3.85	3.85	3.85	3.85	3.85	3.85	3.85	3.85	±0.7
Feed hole center to body center distance	P2	6.35	6.35	6.35	6.35	6.35	6.35	6.35	6.35	6.35	±1.0
Lead to lead distance	F	1.5	2.0	2.0	2.0	2.5	2.5	2.5	3.5	3.5	±0.5
Lead to lead distance	F1	5.0	5.0	5.0	5.0	5.0	5.0	5.0	5.0	5.0	+0.8 -0.2
Height of body from tape center	H	18.5	18.5	18.5	18.5	18.5	18.5	18.5	18.5	18.5	±0.75
Lead wire clinch height	H0	16.0	16.0	16.0	16.0	16.0	16.0	16.0	16.0	16.0	±0.5
Base tape width	W	18.0	18.0	18.0	18.0	18.0	18.0	18.0	18.0	18.0	±0.5
Adhesive tape width	W0	11.0	11.0	11.0	11.0	11.0	11.0	11.0	11.0	11.0	min
Hole position	W1	9.0	9.0	9.0	9.0	9.0	9.0	9.0	9.0	9.0	+0.75 -0.5
Hole down tape position	W2	3.0	3.0	3.0	3.0	3.0	3.0	3.0	3.0	3.0	max

Name	Approval Sheet-WH				
File No.	WH	Version	01	Page	11
STANDARD MANUAL					

Starts	File	Description	Component	No./rev
Released	Approval	Sheet-WH	CRS-2010-WH/ 01	

9.2 端子切脚或成型 Lead Cut& Lead Forming

● **LEAD CUT**
PIN CODE: C
RANGE: $\Phi 4\sim\Phi 18$

● **LEAD FORMING AND CUT**
PIN CODE: F
RANGE: $\Phi 4\sim\Phi 8$

ΦD	F	L	ΦD	F	L
4	1.5	3.0~12.0	4	5.0	3.5, 4.5, 5.0, 7.0
5	2.0	3.0~12.0	5	5.0	3.5, 4.5, 5.0, 7.0
6.3	2.5	3.0~12.0	6.3	5.0	3.5, 4.5, 5.0, 7.0
8	3.5	3.0~12.0	8	5.0	3.5, 4.5, 5.0, 7.0
10	5.0	3.0~12.0	-	-	-
12.5	5.0	3.0~12.0	-	-	-
16	7.5	3.0~12.0	-	-	-
18	7.5	3.0~12.0	-	-	-

● **Kink & cutting**
PIN CODE: J
RANGE: $\Phi 10\sim\Phi 18$

ΦD	F	L
10	5.0	4.0, 4.5, 5.0
12.5	5.0	4.0, 4.5, 5.0
16	7.5	4.0, 4.5, 5.0
18	7.5	4.0, 4.5, 5.0

Name	Approval Sheet-WH				
File No.	WH	Version	01	Page	12
STANDARD MANUAL					

Starts Released	File Description Approval Sheet-WH	Component CRS-2010-WH/ 01	No./rev
--------------------	---------------------------------------	------------------------------	---------

10 包装 Packing

包装标签内容 Packing Label Marked (the following items shall be marked on the label)
(Inside box or bag)

- 1)系列 series 2)料号 P/N 3)容量 Rated capacitance 4)电压 Rated Voltage
- 5)数量 quantity 6)尺寸 size

批号的填写 LOT Number :

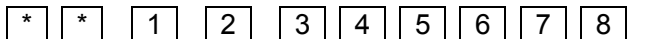

流转单代码 月份 年份 序号
code month year number

编带产品按下图包装 Taped Packing.

单位 unit: mm

ΦD	L(max)	H(max)	W(max)
Φ4、Φ5、 Φ6、Φ8	330	260	50
Φ10	330	260	62

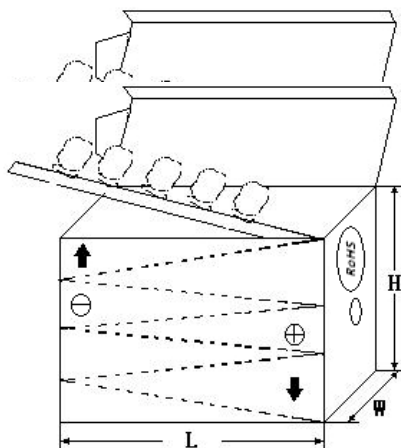

散包装按下图包装方式 Bulk Packing

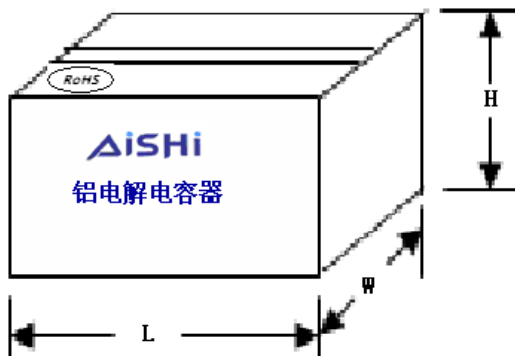

内盒 inner box



外箱 carton

Name	Approval Sheet-WH				
File No.	WH	Version	01	Page	13
STANDARD MANUAL					

<i>Starts</i>	<i>File Description</i>	<i>Component</i>	<i>No./rev</i>
Released	Approval Sheet-WH	CRS-2010-WH/ 01	

11 其它说明 OTHER REMARKS

11.1 铝电解电容器使用注意事项 IMPORTANT INFORMATION ON THE APPLICATION OF ALUMINUM ELECTROLYTIC CAPACITORS

- (1) 直流铝电解电容器应按正确的极性使用 DC aluminum electrolytic capacitors are normally polarized 当直流铝电解电容器按反极性接入电路时，电容器会导致电子线路短路，由此产生的电流会引致电容器损坏。若电路中有可能在负引线施加正电压，请选无极性产品。
When reverse voltage is applied on DC aluminum electrolytic capacitor ,the circuit will be short out and the capacitor will be damaged due to abnormal current flows through the capacitor.Please use non- polar types of capacitors when the positive voltage is applied on the cathode terminal.
- (2) 在额定工作电压以下使用 Use capacitor within rated voltage
当电容器上所施加电压高于额定工作电压时，电容器的漏电流将上升，其电气特性将在短时期内劣化直至损坏。请注意电压峰值勿超出额定工作电压。
When capacitor is used at higher voltage than the rated voltage, leakage current increased, characteristics drastically deteriorated and damaged in a short period may occur as a result. Please take extra caution that the peak voltage should not exceed the rated voltage.
- (3) 作快速充放电使用 Sudden charge and discharge
当常规电容器被用作快速充电用途，其使用寿命可能会因为容量下降，温度急剧上升等而缩减。
When aluminum electrolytic capacitors for general purpose-use are employed in rapid charge and discharge application, its life expectancy may be shortened resulted from capacitance decrease, heat rise, etc.
- (4) 电容器储存 Storage of the capacitor
请保管在室温 5~35℃，湿度 75%以下的环境。
we recommend the following conditions for storage:
Ambient temperature: 5~35℃ ,Ambient humidity: <75%RH;
a) 产品储存期限: ≤12 个月;
Storage life: ≤ 12 months;
b) 产品储存期限>12 个月时，需充电后再使用;
If storage life >12 months, the products need to be charged again before using;
c) 存放时间超过 3 年的电解电容器应报废处理;
If Storage time >three years, the products need to be discarded;
d) 库存有效期以产品套管上印刷的时间开始计算;
Expiry Date: calculating from the date marked on the sleeve;
e) 请尽量以包装状态保管; Please keep capacitors in the original package;
f) 请避免在以下环境下保管: Avoid storing the capacitors under such circumstances:
※ 溅水、高温高湿及结露的环境。 With water and oil or damp &dewing location.
※ 溅油、或者充满气体油成分的环境。 With gas and oil.
※ 充满酸性有毒气体（硫化氢，亚硫酸，亚硝酸，氯，溴，溴化甲烷等）的环境。
With toxic gases such as hydrogen sulfide, sulfurous acid, nitrous acid, chlorine, bromine and methane.
※ 直射阳光、臭氧、紫外线及放射线照射的环境。
With direct sunlight, Ozone, ultraviolet rays or radiation.
- (5) 施加纹波电流应小于额定值 Use capacitor within rated ripple current
施加纹波电流超过额定值后，会导致电容器体过热，容量下降，寿命缩短。电容器上标注了额定电压，请将和直流电压叠加的纹波电压的峰值控制在额定工作电压以下。
If excessive ripple current is applied on the capacitor, excessive heat will be generated inside, the capacitance will be reduced and capacitor's life shall be shortened. Rated voltage has been marked on the capacitor; therefore, the peak value of the ripple voltage should be less than the rated voltage.
- (6) 使用环境温度 Ambient temperature
铝电解电容器的使用寿命会受到环境温度的影响。据科学统计，使用环境温度下降 10℃其使用寿命增加 1 倍。
Life of aluminum electrolytic capacitor is affected by the ambient temperature. It is generally known that the life doubles for each 10℃ decrease in temperature.

Name	Approval Sheet-WH				
File No.	WH	Version	01	Page	14
STANDARD MANUAL					

<i>Starts</i>	<i>File</i>	<i>Description</i>	<i>Component</i>	<i>No./rev</i>
Released	Approval	Sheet-WH	CRS-2010-WH/ 01	

(7)引出线强度 Tensile strength of lead wire

当拉力施加到电容器引出线，该拉力将作用于电容器内部，这可能导致电容器内部短路，开路或漏电流上升。在电容器焊装到电路板，请勿强烈摇动电容器。

When a strong force is applied to the lead wires or terminals, stress is put on the internal connections, which may result in short circuit, open circuit or increased leakage current. So it is not advisable to bend or handle a capacitor after it has been soldered to the PC board.

(8)焊接过程耐热性 Heat resistance at the soldering process

铝电解电容器装至电路板进行浸焊或波峰焊时，其塑料套管可能因焊接时间过长、温度过高而发生破裂或二次收缩。

During soldering process, secondary shrinkage or sleeve crack may occur when soldering temperature is too high or soldering time is too long.

(9)电路板的安装孔孔距及安装位置 Hole pitch and position of PC board

电路板安装孔的设计应与产品说明书的引线脚距相一致，如果将电容器强行插入孔距不配套的电路板，那么会有应力作用于引出线，这可能导致短路或漏电流上升。

When designig a PC board , its hole pitch should be designed to coincide with the lead pitch(lead spacing) of the capacitor specified in the catalog or specifications. When a capacitor is forcibly inserted into an unmatched hole pitch, a force will put on the leads and which could result in a short circuit or increased leakage current.

(10) 关于焊接以后的清洗 Cleaning after soldering

① 电容器不能用卤化有机物系列的清洗剂进行清洗。如果必须进行清洗，请使用能够保证电容器质量的清洗剂。

The aluminum electrolyte capacitors should be free halogenated solvents during board cleaning after soldering. Use solvent proof capacitors when halogenated solvents are used.

② 对于能够保证电容器质量的清洗剂，清洗后请不要在清洗溶液或者密封容器中保管。清洗后的电容器请和电路板一起在热风下干燥 10 分钟以上，热风的温度不可高于电容器规定上限温度。

After cleaned with the solvent which should proof the quality of capacitors, the capacitors should not be kept in solvent environments of non-ventilated places. Let the capacitors after cleaning dry with hot blast fully above 10mins and the temperature of hot blast should not be over than specified upper limit of capacitors.

(11) 关于固定剂以及镀层（涂层剂） Adhesives、fixative and coating materials(coating agent)

① 请不要使用含有卤化有机物系列的固定剂及镀层（涂层剂）。

Do not use halogenated adhesives and coating materials to fix aluminum electrolytic capacitors.

② 请不要让固定剂及镀层（涂层剂）将电容器封口部位（端子一侧）全部封住。

Do not cover up all the sealing area of capacitors with adhesives、fixative or coating materials(coating agent), make coverage only partial

11.2 符合 RoHS RoHS compliance

符合欧盟 RoHS 的最新标准，若客户有特殊要求，按照双方签订的相关协议为准。

Accord with the latest standard of RoHS , if customers have any special requirments, according to the relevant agreements which signed by both parts.

Name	Approval Sheet-WH				
File No.	WH	Version	01	Page	15
STANDARD MANUAL					

X-ON Electronics

Largest Supplier of Electrical and Electronic Components

Click to view similar products for [Aluminium Electrolytic Capacitors - Radial Leaded](#) category:

Click to view products by [Aihua](#) manufacturer:

Other Similar products are found below :

[NRELS102M35V16X16C.140LLF](#) [ESRG160ETC100MD07D](#) [227RZS050M](#) [335CKR250M](#) [476CKH100MSA](#) [477CKR100M](#)
[107CKR010M](#) [107CKH063MSA](#) [RJH-25V222MI9#](#) [RJH-35V221MG5#](#) [B43827A1106M8](#) [RJH-50V221MH6#](#) [EKYA500ELL470MF11D](#)
[B41022A5686M6](#) [ESRG250ELL101MH09D](#) [EKMA160EC3101MF07D](#) [RJB-10V471MG3#](#) [ESMG160ETD221MF11D](#)
[EKZH160ETD152MJ20S](#) [RJH-35V122MJ6#](#) [EGXF630ELL621ML20S](#) [RBD-25V100KE3#N](#) [EKMA350ELL100ME07D](#)
[ESMG160ETD101ME11D](#) [ELXY100ETD102MJ20S](#) [EGXF500ELL561ML15S](#) [EKMG350ETD471MJ16S](#) [35YXA330MEFC10X12.5](#)
[RXW471M1ESA-0815](#) [ELXZ630ELL221MJ25S](#) [ERR1HM1R0D11OT](#) [LPE681M30060FVA](#) [LPL471M22030FVA](#) [HFE221M25030FVA](#)
[LKMD1401H221MF](#) [B41888G6108M000](#) [EKMA160ETD470MF07D](#) [UHW1J102MHD6](#) [EKMG500ETD221MJC5S](#) [LKMK2502W101MF](#)
[LKMD1401H181MF](#) [LKMI2502G820MF](#) [LKMJ2001J122MF](#) [LKML2501C472MF](#) [LKMJ4002C681MF](#) [450MXH330MEFCSN25X45](#)
[450MXK330MA2RFC22X50](#) [63ZLH560MEFCG412.5X30](#) [ELH2DM331O25KT](#) [ELH2DM471P30KT](#)