

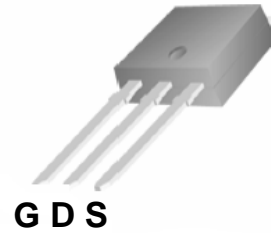

PIN Connection TO-251

General Description

The series of devices use advanced super junction technology and design to provide excellent $R_{DS(ON)}$ with low gate charge. This super junction MOSFET fits the industry's AC-DC SMPS requirements for PFC, AC/DC power conversion, and industrial power applications.



Features

- New technology for high voltage device
- Low on-resistance and low conduction losses
- Small package
- Ultra Low Gate Charge cause lower driving requirements
- 100% Avalanche Tested
- ROHS compliant

Application

- Power factor correction (PFC)
- Switched mode power supplies(SMPS)
- Uninterruptible Power Supply (UPS)

Schematic diagram

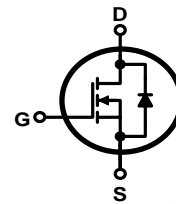

Marking Diagram

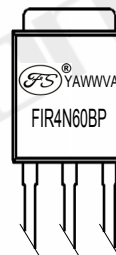

- Y = Year
- A = Assembly Location
- WW = Work Week
- VA = Version & Assembly plant
- FIR4N60BP = Specific Device Code

Table 1. Absolute Maximum Ratings ($T_c=25^\circ\text{C}$)

Parameter	Symbol	Value	Unit
Drain-Source Voltage ($V_{GS}=0V$)	V_{DS}	600	V
Gate-Source Voltage ($V_{DS}=0V$)	V_{GS}	± 30	V
Continuous Drain Current at $T_c=25^\circ\text{C}$	$I_{D(DC)}$	4	A
Continuous Drain Current at $T_c=100^\circ\text{C}$	$I_{D(DC)}$	2.5	A
Pulsed drain current (Note 1)	I_{DM} (pluse)	12	A
Maximum Power Dissipation($T_c=25^\circ\text{C}$)	P_D	77	W
Derate above 25°C		0.62	W/ $^\circ\text{C}$
Single pulse avalanche energy (Note2)	E_{AS}	130	mJ
Avalanche current (Note 1)	I_{AR}	2	A
Repetitive Avalanche energy , t_{AR} limited by T_{jmax} (Note 1)	E_{AR}	0.2	mJ



Operating Junction and Storage Temperature Range	T_J, T_{STG}	-55...+150	°C
--	----------------	------------	----

Table 2. Thermal Characteristic

Parameter	Symbol	Value	Unit
Thermal Resistance, Junction-to-Case (Maximum)	R_{thJC}	1.62	°C /W
Thermal Resistance, Junction-to-Ambient (Maximum)	R_{thJA}	110	°C /W

Table 3. Electrical Characteristics (TA=25°C unless otherwise noted)

Parameter	Symbol	Condition	Min	Typ	Max	Unit
On/off states						
Drain-Source Breakdown Voltage	BV_{DSS}	$V_{GS}=0V, I_D=250\mu A$	600			V
Zero Gate Voltage Drain Current(Tc=25°C)	I_{DSS}	$V_{DS}=600V, V_{GS}=0V$			1	μA
Zero Gate Voltage Drain Current(Tc=125°C)	I_{DSS}	$V_{DS}=600V, V_{GS}=0V$			50	μA
Gate-Body Leakage Current	I_{GSS}	$V_{GS}=\pm 30V, V_{DS}=0V$			±100	nA
Gate Threshold Voltage	$V_{GS(th)}$	$V_{DS}=V_{GS}, I_D=250\mu A$	2.5	3	4.5	V
Drain-Source On-State Resistance	$R_{DS(on)}$	$V_{GS}=10V, I_D=2.5A$		2.2	2.4	Ω
Dynamic Characteristics						
Input Capacitance	C_{iss}	$V_{DS}=50V, V_{GS}=0V, F=1.0MHz$		300		PF
Output Capacitance	C_{oss}			28		PF
Reverse Transfer Capacitance	C_{rss}			2.3		PF
Total Gate Charge	Q_g	$V_{DS}=480V, I_D=4A, V_{GS}=10V$		6.5	10	nC
Gate-Source Charge	Q_{gs}			1.3		nC
Gate-Drain Charge	Q_{gd}			2.5		nC

Switching times						
Turn-on Delay Time	$t_{d(on)}$	$V_{DD}=380V, I_D=2.5A, R_G=20\Omega, V_{GS}=10V$		6		nS
Turn-on Rise Time	t_r			3		nS
Turn-Off Delay Time	$t_{d(off)}$			48	60	nS
Turn-Off Fall Time	t_f			8	15	nS
Source- Drain Diode Characteristics						
Source-drain current(Body Diode)	I_{SD}	$T_C=25^\circ C$		4		A
Pulsed Source-drain current(Body Diode)	I_{SDM}			12		A
Forward On Voltage	V_{SD}	$T_J=25^\circ C, I_{SD}=4A, V_{GS}=0V$		1.4		V
Reverse Recovery Time	t_{rr}	$T_J=25^\circ C, I_F=4A, di/dt=100A/\mu s$		150		nS
Reverse Recovery Charge	Q_{rr}			0.85		uC
Peak reverse recovery current	I_{rrm}			11		A

Notes: 1.Repetitive Rating: Pulse width limited by maximum junction temperature

2. $T_J=25^\circ C, V_{DD}=50V, V_G=10V, R_G=25\Omega$



TYPICAL ELECTRICAL AND THERMAL CHARACTERISTICS (curves)

Figure1. Safe operating area

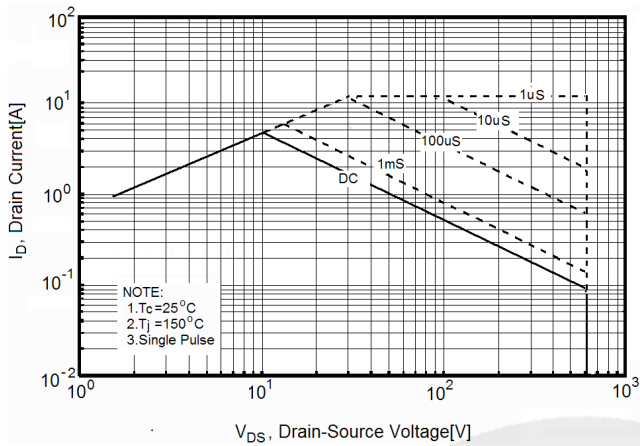

Figure2. Source-Drain Diode Forward Voltage

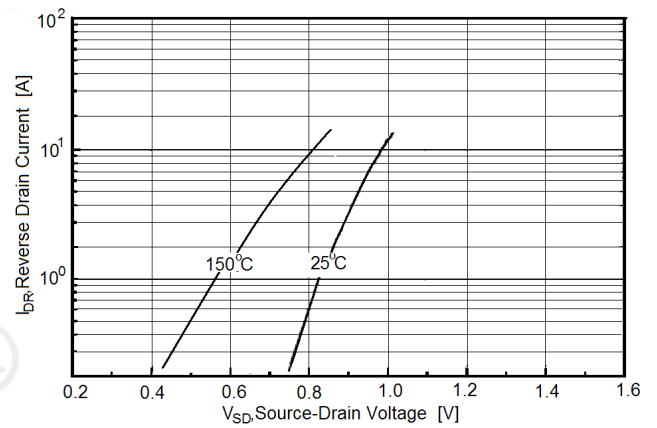

Figure3. Output characteristics

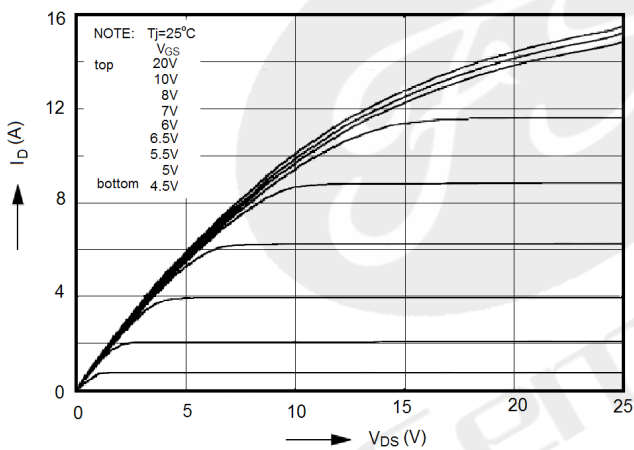

Figure4. Transfer characteristics

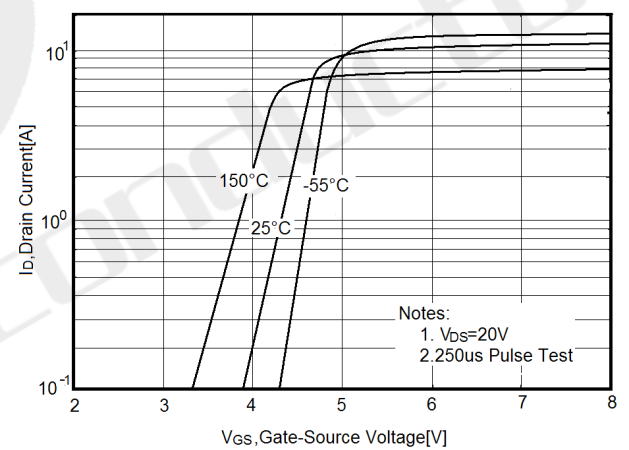

Figure5. Static drain-source on resistance

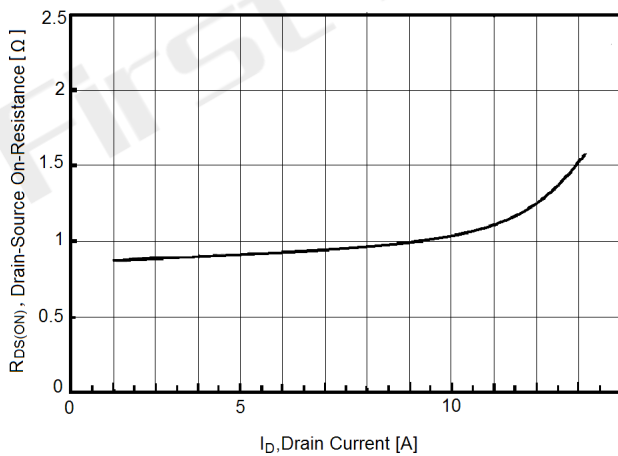

Figure6. $R_{DS(ON)}$ vs Junction Temperature

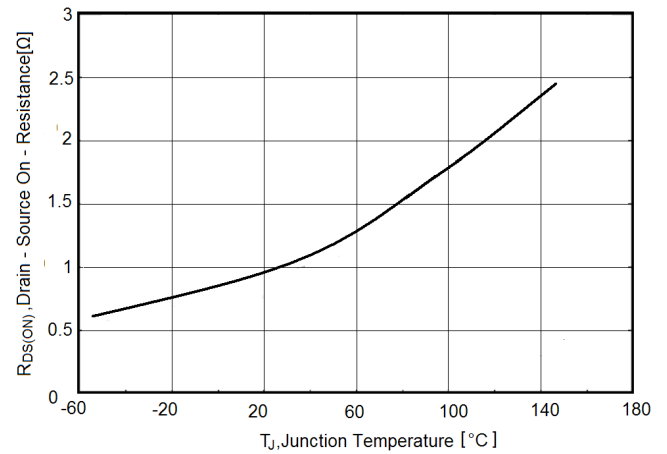



Figure7. BV_{DSS} vs Junction Temperature

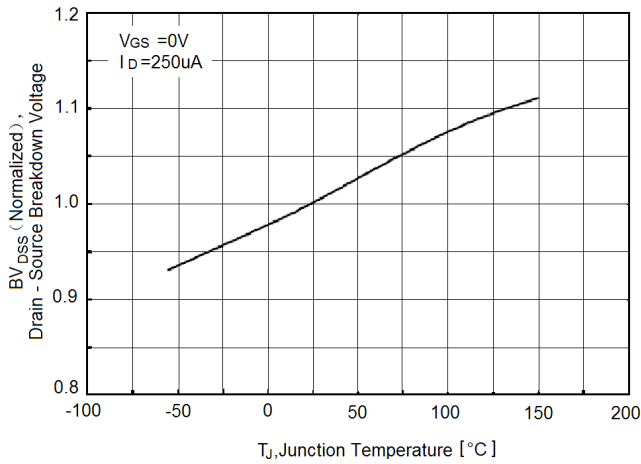

Figure8. Maximum I_D vs Junction Temperature

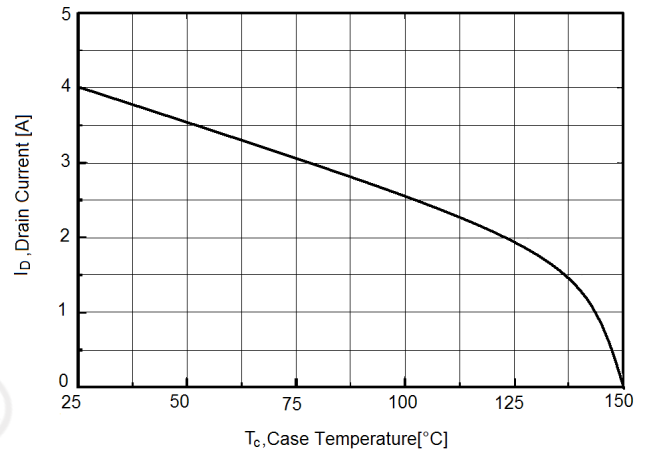

Figure9. Gate charge waveforms

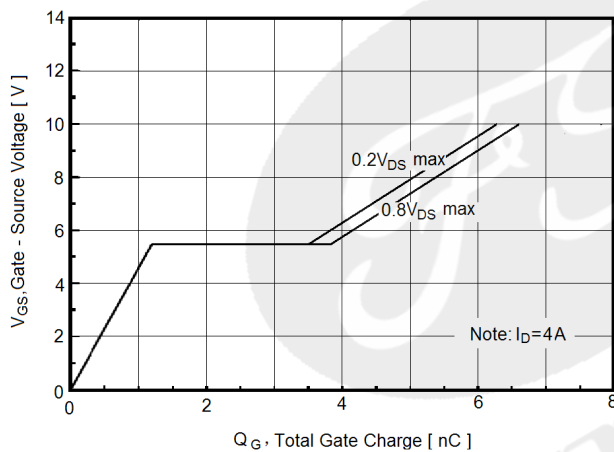

Figure10. Capacitance

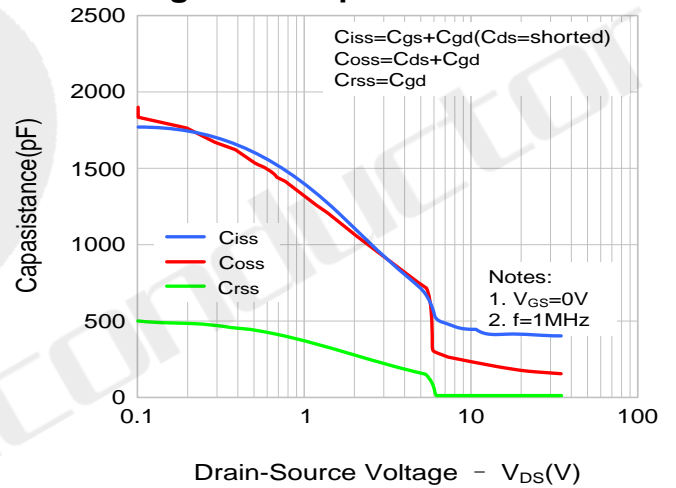
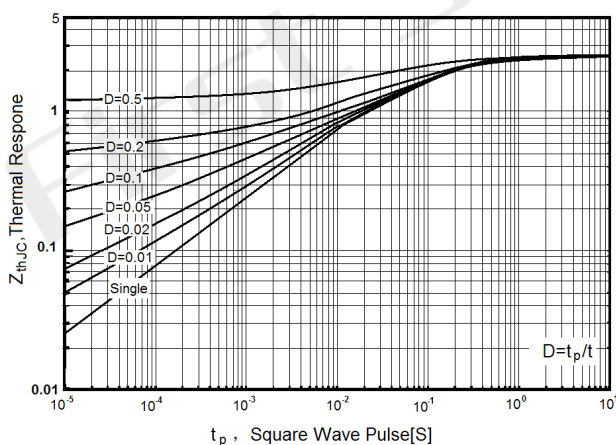
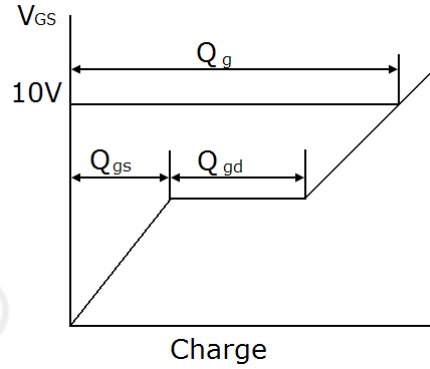
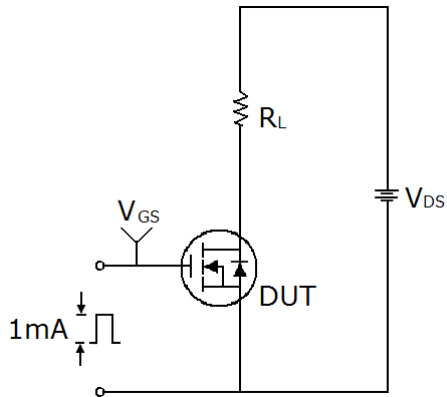

Figure11. Transient Thermal Impedance



Test circuit

1) Gate charge test circuit & Waveform



2) Switch Time Test Circuit:

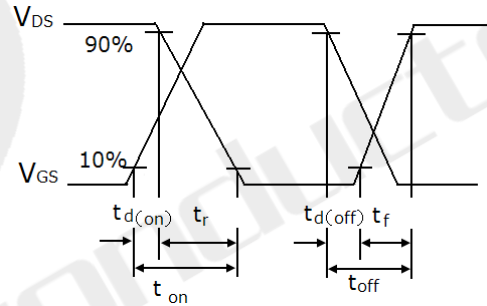
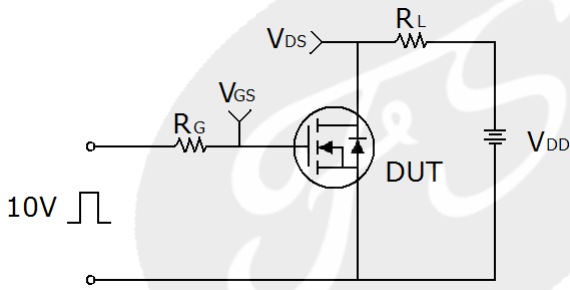

3) Unclamped Inductive Switching Test Circuit & Waveforms

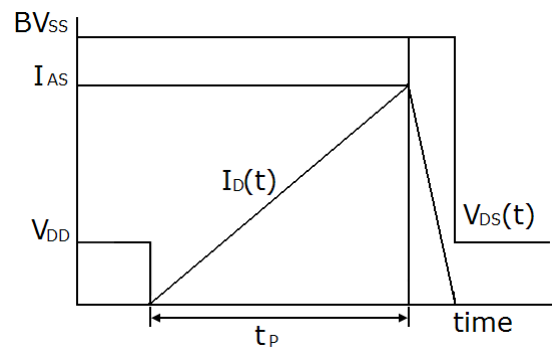
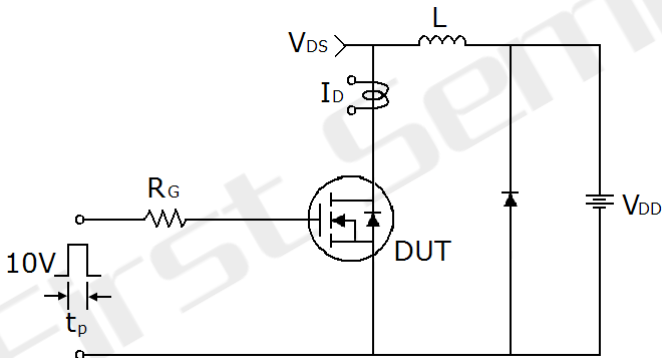



Package Information

TO-251

Units: mm

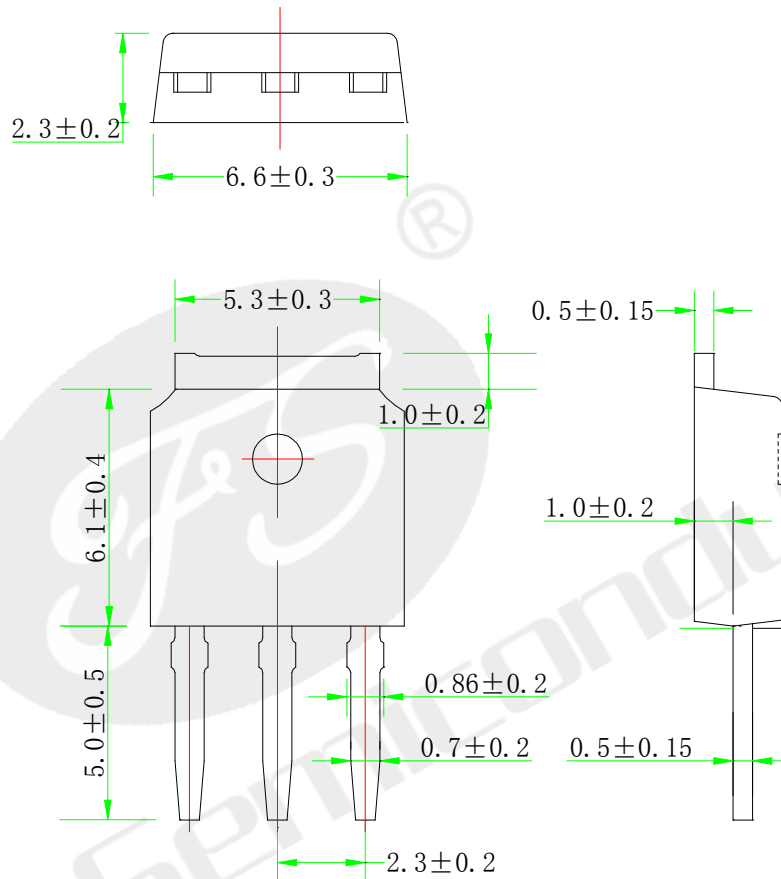



Declaration

- FIRST reserves the right to change the specifications, the same specifications of products due to different packaging line mold, the size of the appearance will be slightly different, shipped in kind, without notice! Customers should obtain the latest version information before ordering, and verify whether the relevant information is complete and up-to-date.
- Any semiconductor product under certain conditions has the possibility of failure or failure, The buyer has the responsibility to comply with safety standards and take safety measures when using FIRST products for system design and manufacturing, To avoid To avoid potential failure risks, which may cause personal injury or property damage!
- Product promotion endless, our company will wholeheartedly provide customers with better products!

ATTACHMENT

Revision History

Date	REV	Description	Page
2018.01.01	1.0	Initial release	

X-ON Electronics

Largest Supplier of Electrical and Electronic Components

Click to view similar products for [MOSFET](#) category:

Click to view products by [First Semicon](#) manufacturer:

Other Similar products are found below :

[614233C](#) [648584F](#) [MCH3443-TL-E](#) [MCH6422-TL-E](#) [FDPF9N50NZ](#) [FW216A-TL-2W](#) [FW231A-TL-E](#) [APT5010JVR](#) [NTNS3A92PZT5G](#)
[IRF100S201](#) [JANTX2N5237](#) [2SK2464-TL-E](#) [2SK3818-DL-E](#) [FCA20N60_F109](#) [FDZ595PZ](#) [STD6600NT4G](#) [FSS804-TL-E](#) [2SJ277-DL-E](#)
[2SK1691-DL-E](#) [2SK2545\(Q,T\)](#) [405094E](#) [423220D](#) [MCH6646-TL-E](#) [TPCC8103,L1Q\(CM](#) [367-8430-0972-503](#) [VN1206L](#) [424134F](#)
[026935X](#) [051075F](#) [SBVS138LT1G](#) [614234A](#) [715780A](#) [NTNS3166NZT5G](#) [751625C](#) [873612G](#) [IRF7380TRHR](#) [IPS70R2K0CEAKMA1](#)
[RJK60S3DPP-E0#T2](#) [RJK60S5DPK-M0#T0](#) [APT5010JVFR](#) [APT12031JFLL](#) [APT12040JVR](#) [DMN3404LQ-7](#) [NTE6400](#) [JANTX2N6796U](#)
[JANTX2N6784U](#) [JANTXV2N5416U4](#) [SQM110N05-06L-GE3](#) [SIHF35N60E-GE3](#) [2SK2614\(TE16L1,Q\)](#)