

1 MHz Bandwidth, Galvanically Isolated Current Sensor IC in Small Footprint SOIC8 Package

FEATURES AND BENEFITS

- Industry-leading noise performance with greatly improved bandwidth through proprietary amplifier and filter design techniques
- High bandwidth 1 MHz analog output
- Patented integrated digital temperature compensation circuitry allows high accuracy over temperature in an open loop sensor
- 1.2 mΩ primary conductor resistance for low power loss and high inrush current withstanding capability
- Small footprint, low-profile SOIC8 package suitable for space-constrained applications
- Integrated shield virtually eliminates capacitive coupling from current conductor to die due to high dV/dt voltage transients
- 5 V, single supply operation
- Output voltage proportional to AC or DC current
- Factory-trimmed sensitivity and quiescent output voltage for improved accuracy
- High PSRR for noisy environments

DESCRIPTION

The Allegro™ ACS730 current sensor family provides economical and precise solutions for AC or DC current sensing in industrial, commercial, and communications systems. The device package allows for easy implementation by the customer. Typical applications include motor control, load detection and management, switched-mode power supplies, and overcurrent fault protection.

The device consists of a precise, low-offset, linear Hall sensor circuit with a copper conduction path located near the surface of the die. Applied current flowing through this copper conduction path generates a magnetic field which is sensed by the integrated Hall IC and converted into a proportional voltage. Device accuracy is optimized through the close proximity of the magnetic field to the Hall transducer. A precise, proportional voltage is provided by the Hall IC, which is programmed for accuracy after packaging. The output of the device has a positive slope when an increasing current flows through the primary copper conduction path (from pins 1 and 2, to pins 3 and 4), which is the path used for current sensing. The internal resistance of this conductive path is typically 1.2 mΩ, providing low power loss.

The terminals of the conductive path are electrically isolated from the sensor leads (pins 5 through 8). This allows the ACS730 current sensor to be used in high-side current sense applications without the use of high-side differential amplifiers or other costly isolation techniques.

The ACS730 is provided in a small, low-profile surface-mount SOIC8 package. The leadframe is plated with 100% matte tin, which is compatible with standard lead (Pb) free printed circuit board assembly processes. Internally, the device is Pb-free, except for flip-chip high-temperature Pb-based solder balls, currently exempt from RoHS. The device is fully calibrated prior to shipment from the factory.

Package: 8-Pin SOIC (suffix LC)

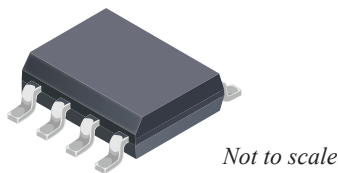

Not to scale

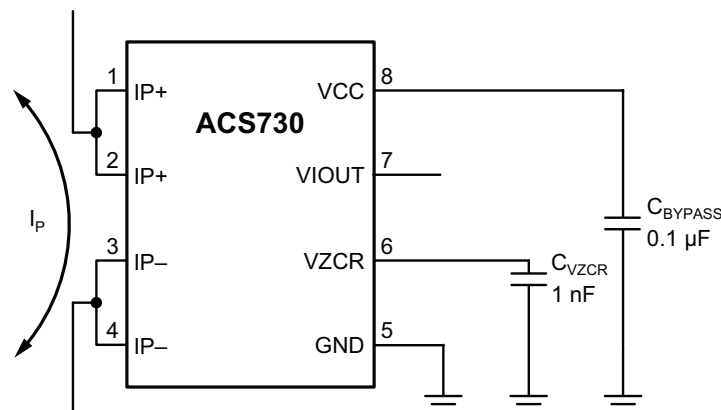

The ACS730 outputs an analog signal, V_{IOOUT} , that varies linearly with the bidirectional AC or DC primary sensed current, I_P , within the range specified.

Typical Application

SELECTION GUIDE

Part Number	Optimized Range, I_P (A)	Sensitivity [1], Sens(Typ) (mV/A)	T_A (°C)	Packing [2]
ACS730KLCTR-20AB-T	±20	100	-40 to 125	Tape and reel, 3000 pieces per reel
ACS730KLCTR-40AB-T	±40	50		
ACS730KLCTR-40AU-T	40	100		
ACS730KLCTR-50AB-T	±50	40		
ACS730KLCTR-80AU-T	80	50		

[1] Measured at $V_{CC} = 5\text{ V}$.

[2] Contact Allegro for additional packing options.

SPECIFICATIONS

ABSOLUTE MAXIMUM RATINGS

Characteristic	Symbol	Notes	Rating	Units
Supply Voltage	V_{CC}		6	V
Reverse Supply Voltage	$V_{CC(R)}$		-0.1	V
Output Voltage	V_{IOUT}		6	V
Reverse Output Voltage	$V_{IOUT(R)}$		-0.1	V
Zero Current Reference Voltage	V_{ZCR}		20	V
Reverse Zero Current Reference Voltage	$V_{ZCR(R)}$		-0.1	V
Operating Ambient Temperature	T_A	Range K	-40 to 125	°C
Junction Temperature	$T_J(\text{max})$		165	°C
Storage Temperature	T_{stg}		-65 to 170	°C

ISOLATION CHARACTERISTICS

Characteristic	Symbol	Notes	Value	Units
Dielectric Strength Test Voltage	V_{ISO}	Agency type-tested for 60 seconds per UL standard 60950-1 (edition 2); production-tested at VISO for 1 second, in accordance with UL 60950-1 (edition 2).	2400	V_{RMS}
		Agency type-tested for 60 seconds per UL 1577 (edition 5); production-tested at 2520 VRMS for 1 second, in accordance with UL 1577 (edition 5).	2100	V_{RMS}
Working Voltage for Basic Isolation	V_{WVBI}	Maximum approved working voltage for basic (single) isolation according to UL 60950-1 (edition 2).	420	V_{PK} or VDC
			297	V_{RMS}
Clearance	D_{cl}	Minimum distance through air from IP leads to signal leads	3.9	mm
Creepage	D_{cr}	Minimum distance along package body from IP leads to signal leads	3.9	mm

THERMAL CHARACTERISTICS

Characteristic	Symbol	Test Conditions [1]	Value	Units
Package Thermal Resistance (Junction to Ambient)	$R_{\theta JA}$	Mounted on the Allegro 85-xxxx evaluation board with 1500 mm ² of 2 oz. copper on each side, connected to pins 1 and 2, and to pins 3 and 4, with thermal vias connecting the layers. Performance values include the power consumed by the PCB. [2]	23	°C/W
Package Thermal Resistance (Junction to Lead)	$R_{\theta JL}$	Mounted on the Allegro ASEK730 evaluation board.	5	°C/W

[1] Additional thermal information available on the Allegro website.

[2] Further details on the board are available from the Frequently Asked Questions document on our website. Further information about board design and thermal performance also can be found in the Applications Information section of this datasheet.

Pinout Diagram and Terminal List Table

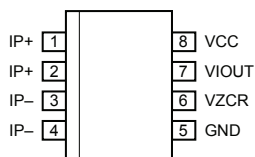

**Package LC, 8-Pin SOICN
Pinout Diagram**

Terminal List Table

Number	Name	Description
1, 2	IP+	Terminals for current being sensed; fused internally
3, 4	IP-	Terminals for current being sensed; fused internally
5	GND	Signal ground terminal
6	VZCR	Zero current reference; outputs a DC voltage equal to V_{IOUT} at $I_P = 0 A$
7	VIOUT	Analog output signal
8	VCC	Device power supply terminal

Functional Block Diagram

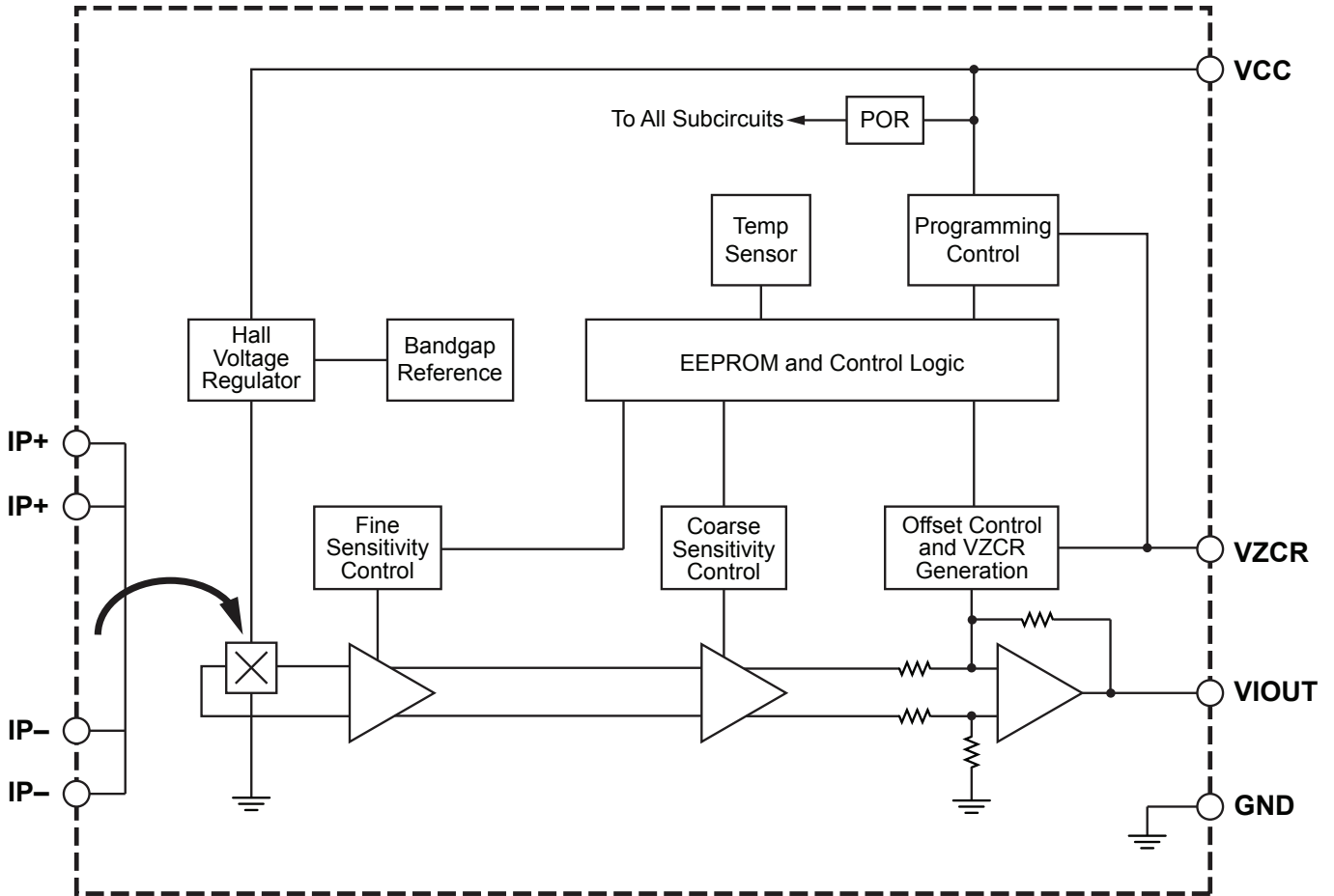

COMMON ELECTRICAL CHARACTERISTICS [1]: Valid over full range of T_A , $V_{CC} = 5\text{ V}$, unless otherwise specified

Characteristic	Symbol	Test Conditions	Min.	Typ.	Max.	Unit
Supply Voltage	V_{CC}		4.5	5	5.5	V
Supply Current	I_{CC}	$V_{CC} = 5\text{ V}$, output open	–	17	25	mA
Power-On Time	t_{PO}	$T_A = 25^\circ\text{C}$	–	150	–	μs
Output Capacitance Load	C_L	VIOUT to GND	–	–	0.47	nF
Reference Capacitance Load	C_{VZCR}	VZCR to GND	–	–	1	nF
Output Resistive Load	R_L	VIOUT to GND, VIOUT to VCC	10	–	–	k Ω
Reference Resistive Load	R_{VZCR}	VIOUT to GND, VZCR to VCC	10	–	–	k Ω
Output High Saturation Voltage [2]	V_{OH}	VIOUT, $T_A = 25^\circ\text{C}$	$V_{CC} - 0.4$	$V_{CC} - 0.3$	–	V
Output Low Saturation Voltage [2]	V_{OL}	VIOUT, $T_A = 25^\circ\text{C}$	–	0.1	0.2	V
Primary Conductor Resistance	R_{IP}	$T_A = 25^\circ\text{C}$	–	1.2	–	m Ω
Magnetic Coupling Factor	MCF	$T_A = 25^\circ\text{C}$	–	10	–	G/A
Rise Time	t_r	$T_A = 25^\circ\text{C}$, $C_L = 0.47\text{ nF}$, 1 V step on output	–	0.6	–	μs
Response Time	$t_{RESPONSE}$	$T_A = 25^\circ\text{C}$, $C_L = 0.47\text{ nF}$, 1 V step on output	–	0.7	–	μs
Internal Bandwidth	BW	Small signal –3 dB; $C_L = 0.47\text{ nF}$	–	1	–	MHz
Noise Density	I_{ND}	Input-referenced noise density; $T_A = 25^\circ\text{C}$, $C_L = 0.47\text{ nF}$	–	40	–	$\mu\text{A}/\sqrt{\text{Hz}}$
Noise	I_N	Input-referenced noise; $T_A = 25^\circ\text{C}$, $C_L = 0.47\text{ nF}$	–	40	–	mA _{RMS}
Power Supply Rejection Ratio	PSRR	0 to 200 Hz, 100 mV pk-pk ripple on V_{CC} , $I_P = 0\text{ A}$, VIOUT and VZCR	–	35	–	dB
Sensitivity Power Supply Rejection Ratio	SPSRR	DC, $V_{CC}(\text{min}) < V_{CC} < V_{CC}(\text{max})$, $I_P = I_{PR}(\text{max})$	–	15	–	dB
Offset Power Supply Rejection Ratio	OPSRR	DC, $V_{CC}(\text{min}) < V_{CC} < V_{CC}(\text{max})$	–	30	–	dB
Output Source Current	$I_{OUT(\text{src})}$	VIOUT shorted to GND	–	5.5	–	mA
Output Sink Current	$I_{OUT(\text{snk})}$	VIOUT shorted to VCC	–	3	–	mA
Zero Current Reference Voltage	V_{ZCR}	$T_A = 25^\circ\text{C}$	–	2.5	–	V
Zero Current Reference Offset Voltage	$V_{ZCR(\text{ofs})}$	$T_A = 25^\circ\text{C}$	–10	± 3	10	mV
		$T_A = 25^\circ\text{C}$ to 125°C	–20	± 10	20	mV
		$T_A = -40^\circ\text{C}$ to 25°C	–	± 10	–	mV
Reference Source Current	$I_{VZCR(\text{src})}$	VZCR shorted to GND	–	2	–	mA
Reference Sink Current	$I_{VZCR(\text{snk})}$	VZCR shorted to VCC	–	14	–	mA

[1] Device may be operated at higher primary current levels, I_P , ambient temperatures, T_A , and internal leadframe temperatures, provided the Maximum Junction Temperature, $T_J(\text{max})$, is not exceeded.

[2] The sensor IC will continue to respond to current beyond the range of I_P until the high or low saturation voltage; however, the nonlinearity in this region will be worse than through the rest of the measurement range.

xKLCTR-20AB PERFORMANCE CHARACTERISTICS: Valid over full range of T_A , $V_{CC} = 5\text{ V}$, $C_{BYPASS} = 0.1\ \mu\text{F}$, unless otherwise specified

Characteristic	Symbol	Test Conditions	Min.	Typ. [1]	Max.	Unit
NOMINAL PERFORMANCE						
Current Sensing Range	I_{PR}		-20	-	20	A
Sensitivity	Sens		-	100	-	mV/A
Zero Current Output Voltage	$V_{IOUT(Q)}$	$I_P = 0\text{ A}$, $T_A = 25^\circ\text{C}$	-	2.5	-	V
ACCURACY PERFORMANCE						
Total Output Error [2]	E_{TOT}	$I_P = I_{P(MAX)}$; $T_A = 25^\circ\text{C}$ to 125°C	-4	± 3	4	%
		$I_P = I_{P(MAX)}$; $T_A = -40^\circ\text{C}$ to 25°C	-	± 4	-	%
Sensitivity Error	E_{sens}	$I_P = I_{P(MAX)}$; $T_A = 25^\circ\text{C}$ to 125°C	-2.5	± 1.5	2.5	%
		$I_P = I_{P(MAX)}$; $T_A = -40^\circ\text{C}$ to 25°C	-	± 4	-	%
Offset Voltage	V_{OE}	$I_P = 0\text{ A}$; $T_A = 25^\circ\text{C}$ to 125°C	-75	± 50	75	mV
		$I_P = 0\text{ A}$; $T_A = -40^\circ\text{C}$ to 25°C	-	± 50	-	mV
Nonlinearity	E_{LIN}	Through the full range of I_P ; $T_A = 25^\circ\text{C}$ to 125°C	-2	± 0.75	2	%
		Through the full range of I_P ; $T_A = -40^\circ\text{C}$ to 25°C	-	± 0.75	-	%
LIFETIME DRIFT CHARACTERISTICS						
Total Output Error Including Lifetime Drift	E_{tot_drift}	$I_P = 20\text{ A}$	-	± 6.7	-	%
Sensitivity Error Including Lifetime Drift	E_{sens_drift}	$I_P = 20\text{ A}$	-	± 3.8	-	%
Offset Voltage Including Lifetime Drift	V_{off_drift}	$I_P = 0\text{ A}$	-	± 118	-	mV

[1] Typical values with \pm are 3 sigma values.

[2] Percentage of I_P .

xKLCTR-40AB PERFORMANCE CHARACTERISTICS: Valid over full range of T_A , $V_{CC} = 5\text{ V}$, $C_{BYPASS} = 0.1\ \mu\text{F}$, unless otherwise specified

Characteristic	Symbol	Test Conditions	Min.	Typ. [1]	Max.	Unit
NOMINAL PERFORMANCE						
Current Sensing Range	I_{PR}		-40	-	40	A
Sensitivity	Sens		-	50	-	mV/A
Zero Current Output Voltage	$V_{IOUT(Q)}$	$I_P = 0\text{ A}$, $T_A = 25^\circ\text{C}$	-	2.5	-	V
ACCURACY PERFORMANCE						
Total Output Error [2]	E_{TOT}	$I_P = I_{P(MAX)}$; $T_A = 25^\circ\text{C}$ to 125°C	-5	± 3	5	%
		$I_P = I_{P(MAX)}$; $T_A = -40^\circ\text{C}$ to 25°C	-	± 5	-	%
Sensitivity Error	E_{sens}	$I_P = I_{P(MAX)}$; $T_A = 25^\circ\text{C}$ to 125°C	-3.5	± 2.5	3.5	%
		$I_P = I_{P(MAX)}$; $T_A = -40^\circ\text{C}$ to 25°C	-	± 5	-	%
Offset Voltage	V_{OE}	$I_P = 0\text{ A}$; $T_A = 25^\circ\text{C}$ to 125°C	-40	± 20	40	mV
		$I_P = 0\text{ A}$; $T_A = -40^\circ\text{C}$ to 25°C	-	± 30	-	mV
Nonlinearity	E_{LIN}	Through the full range of I_P ; $T_A = 25^\circ\text{C}$ to 125°C	-2	± 0.75	2	%
		Through the full range of I_P ; $T_A = -40^\circ\text{C}$ to 25°C	-	± 0.75	-	%
LIFETIME DRIFT CHARACTERISTICS						
Total Output Error Including Lifetime Drift	E_{tot_drift}	$I_P = 40\text{ A}$	-	± 6.7	-	%
Sensitivity Error Including Lifetime Drift	E_{sens_drift}	$I_P = 20\text{ A}$	-	± 3.8	-	%
Offset Voltage Including Lifetime Drift	V_{off_drift}	$I_P = 0\text{ A}$	-	± 118	-	mV

[1] Typical values with \pm are 3 sigma values.

[2] Percentage of I_P .

xKLCTR-40AU PERFORMANCE CHARACTERISTICS: Valid over full range of T_A , $V_{CC} = 5\text{ V}$, $C_{BYPASS} = 0.1\ \mu\text{F}$, unless otherwise specified

Characteristic	Symbol	Test Conditions	Min.	Typ. [1]	Max.	Unit
NOMINAL PERFORMANCE						
Current Sensing Range	I_{PR}		0	–	40	A
Sensitivity	Sens		–	100	–	mV/A
Zero Current Output Voltage	$V_{IOUT(Q)}$	$I_P = 0\text{ A}$, $T_A = 25^\circ\text{C}$	–	0.5	–	V
ACCURACY PERFORMANCE						
Total Output Error [2]	E_{TOT}	$I_P = I_{P(MAX)}$; $T_A = 25^\circ\text{C}$ to 125°C	–5	± 2.6	5	%
		$I_P = I_{P(MAX)}$; $T_A = -40^\circ\text{C}$ to 25°C	–8	± 3.7	8	%
Sensitivity Error	E_{sens}	$I_P = I_{P(MAX)}$; $T_A = 25^\circ\text{C}$ to 125°C	–3.5	± 1.2	3.5	%
		$I_P = I_{P(MAX)}$; $T_A = -40^\circ\text{C}$ to 25°C	–7.5	± 3.7	7.5	%
Offset Voltage	V_{OE}	$I_P = 0\text{ A}$; $T_A = 25^\circ\text{C}$ to 125°C	–40	± 35	40	mV
		$I_P = 0\text{ A}$; $T_A = -40^\circ\text{C}$ to 25°C	–80	± 38	80	mV
Nonlinearity	E_{LIN}	Through the full range of I_P ; $T_A = 25^\circ\text{C}$ to 125°C	–2	± 1	2	%
		Through the full range of I_P ; $T_A = -40^\circ\text{C}$ to 25°C	–5	± 2.3	5	%
LIFETIME DRIFT CHARACTERISTICS						
Total Output Error Including Lifetime Drift	E_{tot_drift}	$I_P = 40\text{ A}$	–	± 6.7	–	%
Sensitivity Error Including Lifetime Drift	E_{sens_drift}	$I_P = 20\text{ A}$	–	± 3.8	–	%
Offset Voltage Including Lifetime Drift	V_{off_drift}	$I_P = 0\text{ A}$	–	± 118	–	mV

[1] Typical values with \pm are 3 sigma values.

[2] Percentage of I_P .

xKLCTR-50AB PERFORMANCE CHARACTERISTICS: Valid over full range of T_A , $V_{CC} = 5\text{ V}$, $C_{BYPASS} = 0.1\ \mu\text{F}$, unless otherwise specified

Characteristic	Symbol	Test Conditions	Min.	Typ. [1]	Max.	Unit
NOMINAL PERFORMANCE						
Current Sensing Range	I_{PR}		–50	–	50	A
Sensitivity	Sens		–	40	–	mV/A
Zero Current Output Voltage	$V_{IOUT(Q)}$	$I_P = 0\text{ A}$, $T_A = 25^\circ\text{C}$	–	2.5	–	V
ACCURACY PERFORMANCE						
Total Output Error [2]	E_{TOT}	$I_P = I_{P(MAX)}$; $T_A = 25^\circ\text{C}$ to 125°C	–5	± 3	5	%
		$I_P = I_{P(MAX)}$; $T_A = -40^\circ\text{C}$ to 25°C	–	± 5	–	%
Sensitivity Error	E_{sens}	$I_P = I_{P(MAX)}$; $T_A = 25^\circ\text{C}$ to 125°C	–3.5	± 3	3.5	%
		$I_P = I_{P(MAX)}$; $T_A = -40^\circ\text{C}$ to 25°C	–	± 5	–	%
Offset Voltage	V_{OE}	$I_P = 0\text{ A}$; $T_A = 25^\circ\text{C}$ to 125°C	–40	± 20	40	mV
		$I_P = 0\text{ A}$; $T_A = -40^\circ\text{C}$ to 25°C	–	± 30	–	mV
Nonlinearity	E_{LIN}	Through the full range of I_P ; $T_A = 25^\circ\text{C}$ to 125°C	–2	± 0.75	2	%
		Through the full range of I_P ; $T_A = -40^\circ\text{C}$ to 25°C	–	± 0.75	–	%
LIFETIME DRIFT CHARACTERISTICS						
Total Output Error Including Lifetime Drift	E_{tot_drift}	$I_P = 50\text{ A}$	–	± 6.7	–	%
Sensitivity Error Including Lifetime Drift	E_{sens_drift}	$I_P = 25\text{ A}$	–	± 3.8	–	%
Offset Voltage Including Lifetime Drift	V_{off_drift}	$I_P = 0\text{ A}$	–	± 118	–	mV

[1] Typical values with \pm are 3 sigma values.

[2] Percentage of I_P .

xKLCTR-80AU PERFORMANCE CHARACTERISTICS: Valid over full range of T_A , $V_{CC} = 5\text{ V}$, $C_{BYPASS} = 0.1\ \mu\text{F}$, unless otherwise specified

Characteristic	Symbol	Test Conditions	Min.	Typ. [1]	Max.	Unit
NOMINAL PERFORMANCE						
Current Sensing Range	I_{PR}		0	–	80	A
Sensitivity	Sens		–	50	–	mV/A
Zero Current Output Voltage	$V_{IOUT(Q)}$	$I_P = 0\text{ A}$, $T_A = 25^\circ\text{C}$	–	0.5	–	V
ACCURACY PERFORMANCE						
Total Output Error [2]	E_{TOT}	$I_P = I_{P(MAX)}$; $T_A = 25^\circ\text{C}$ to 125°C	–5	± 1.8	5	%
		$I_P = I_{P(MAX)}$; $T_A = -40^\circ\text{C}$ to 25°C	–8	± 5	8	%
Sensitivity Error	E_{sens}	$I_P = I_{P(MAX)}$; $T_A = 25^\circ\text{C}$ to 125°C	–3.5	± 1.5	3.5	%
		$I_P = I_{P(MAX)}$; $T_A = -40^\circ\text{C}$ to 25°C	–7.5	± 4.2	7.5	%
Offset Voltage	V_{OE}	$I_P = 0\text{ A}$; $T_A = 25^\circ\text{C}$ to 125°C	–40	± 21	40	mV
		$I_P = 0\text{ A}$; $T_A = -40^\circ\text{C}$ to 25°C	–80	± 27	80	mV
Nonlinearity	E_{LIN}	Through the full range of I_P ; $T_A = 25^\circ\text{C}$ to 125°C	–2	± 0.3	2	%
		Through the full range of I_P ; $T_A = -40^\circ\text{C}$ to 25°C	–5	± 2.3	5	%
LIFETIME DRIFT CHARACTERISTICS						
Total Output Error Including Lifetime Drift	E_{tot_drift}	$I_P = 50\text{ A}$	–	± 6.7	–	%
Sensitivity Error Including Lifetime Drift	E_{sens_drift}	$I_P = 25\text{ A}$	–	± 3.8	–	%
Offset Voltage Including Lifetime Drift	V_{off_drift}	$I_P = 0\text{ A}$	–	± 118	–	mV

[1] Typical values with \pm are 3 sigma values.

[2] Percentage of I_P .

CHARACTERISTIC PERFORMANCE

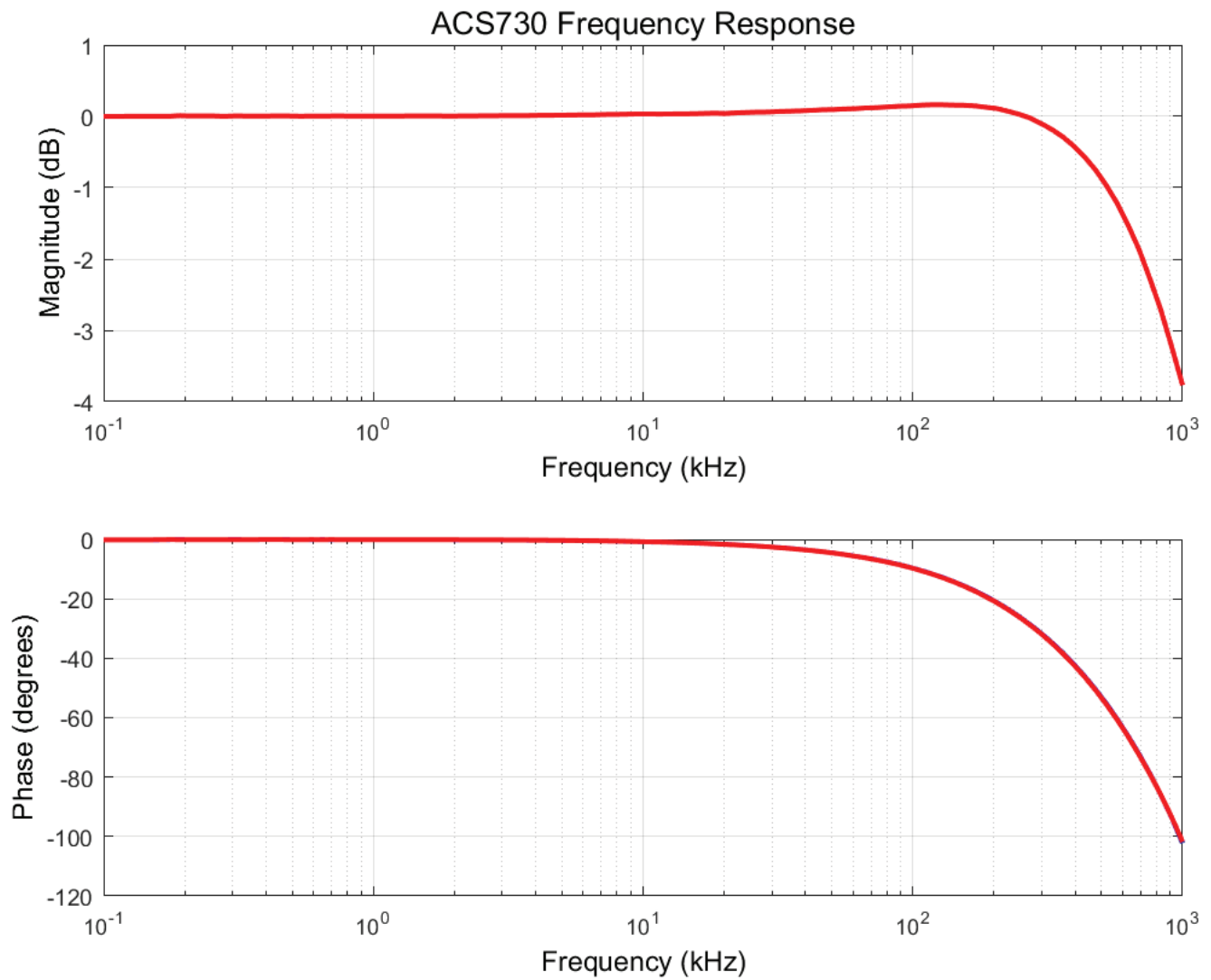

Response Time (t_{RESPONSE})

10 A input signal (I_P) with rise time $< 1 \mu\text{s}$

Sensitivity = 100 mV/A, $C_{\text{BYPASS}} = 0.1 \mu\text{F}$, $C_L = 470 \text{ pF}$, $V_{\text{ZCR}} = 1 \text{ nF}$

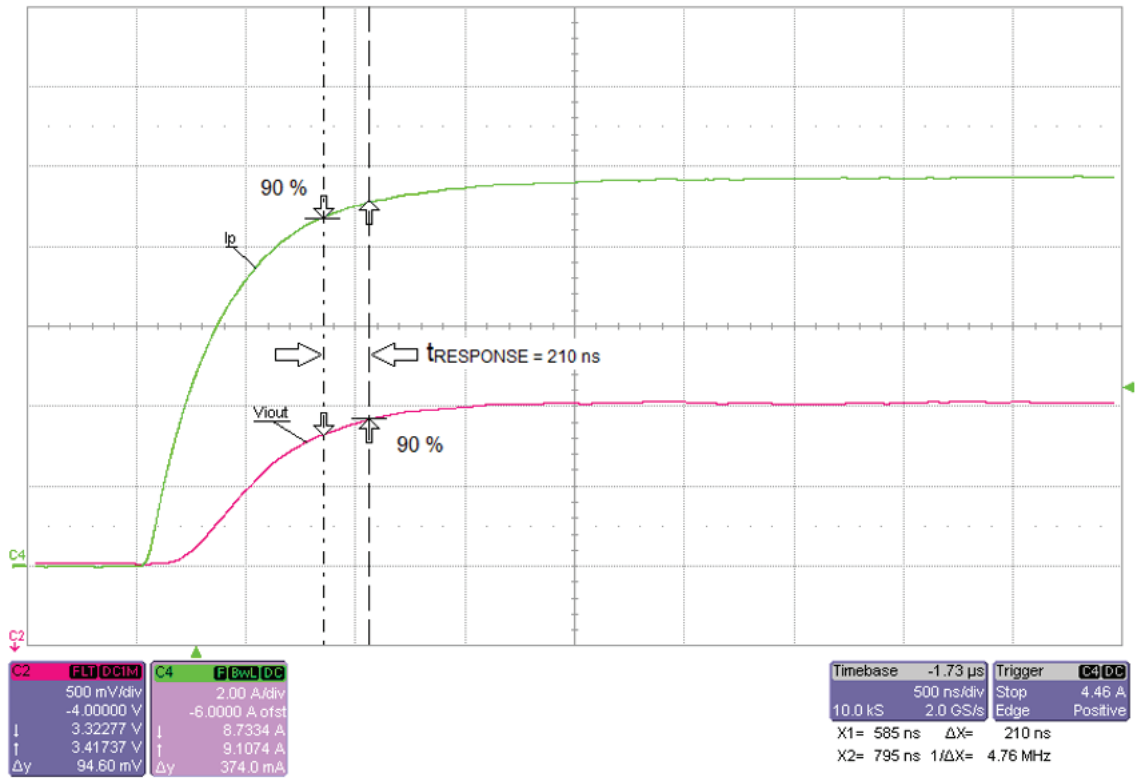

Propagation Delay (t_{PD})

10 A input signal (I_P) with rise time $< 1 \mu s$

Sensitivity = 100 mV/A, $C_{BYPASS} = 0.1 \mu F$, $C_L = 470 pF$, $V_{ZCR} = 1 nF$

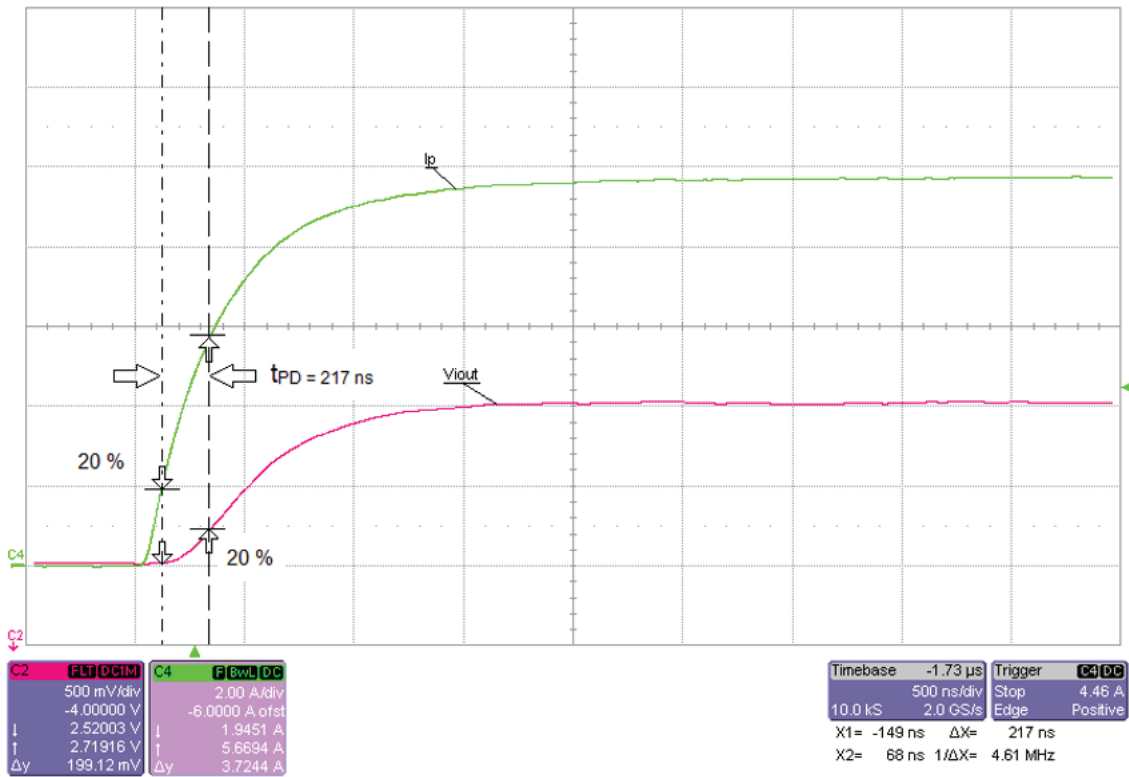

Rise Time (t_{RISE})

10 A input signal (I_P) with rise time $< 1 \mu s$

Sensitivity = 100 mV/A, $C_{BYPASS} = 0.1 \mu F$, $C_L = 470 pF$, $V_{ZCR} = 1 nF$

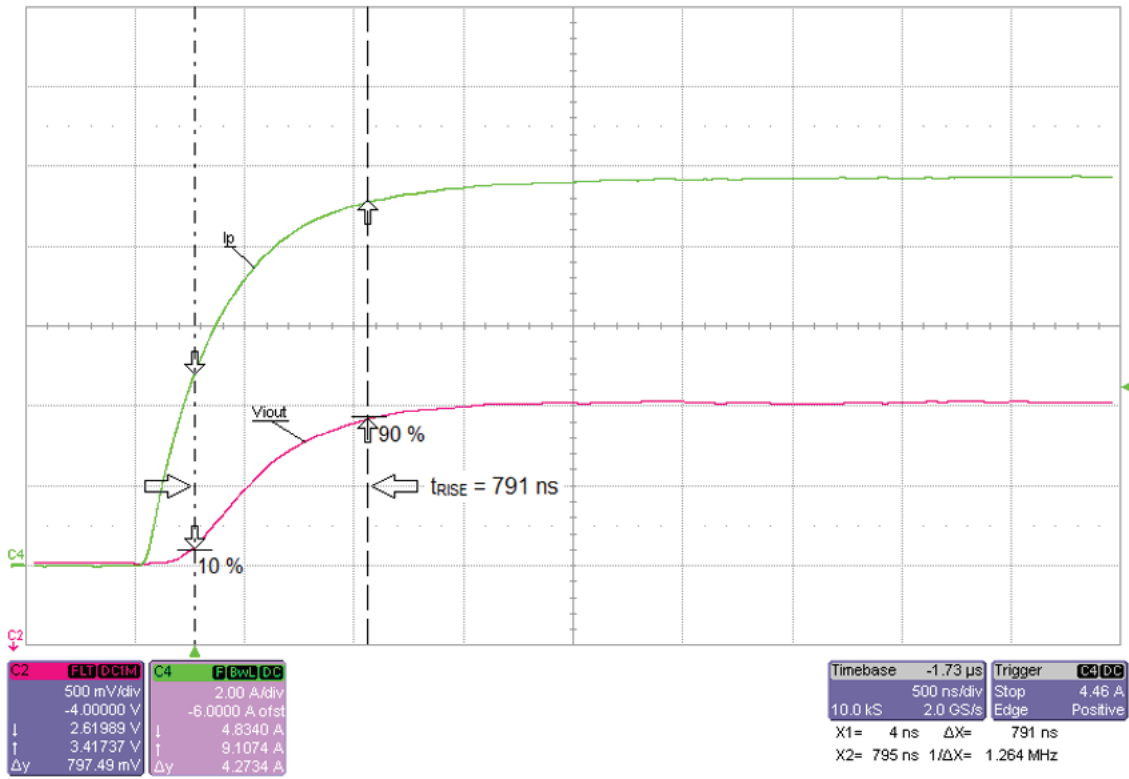

CHARACTERISTIC PERFORMANCE xKLCTR-20AB Key Parameters

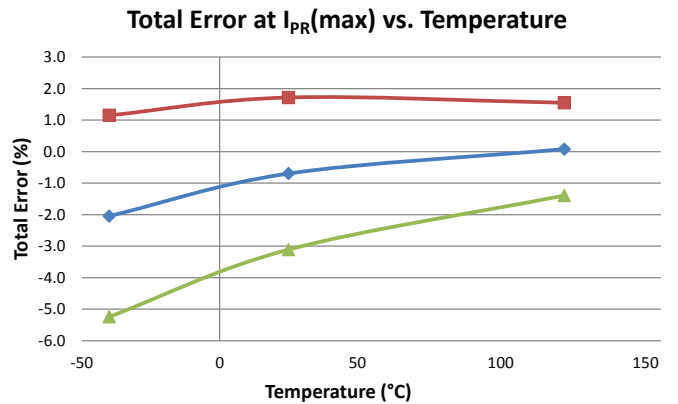
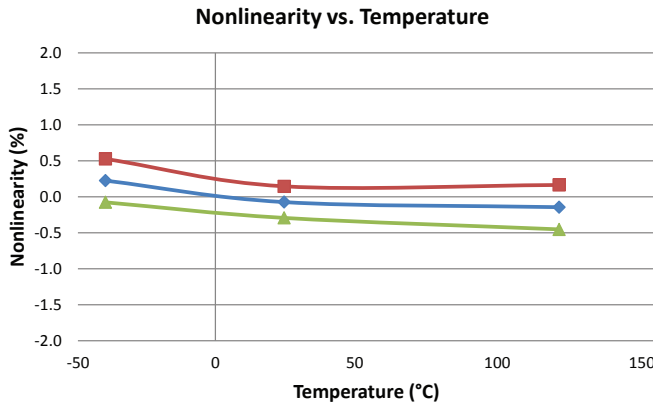
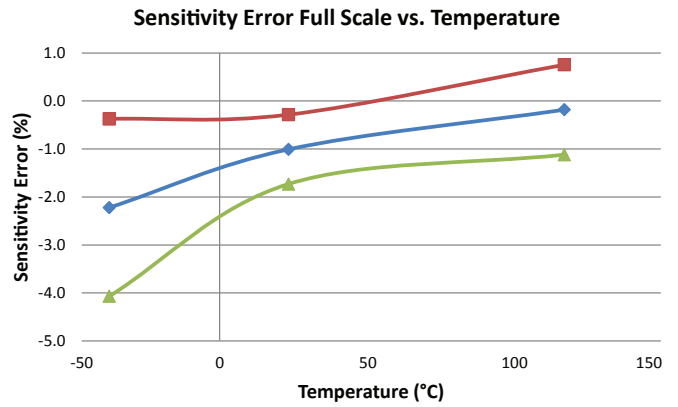
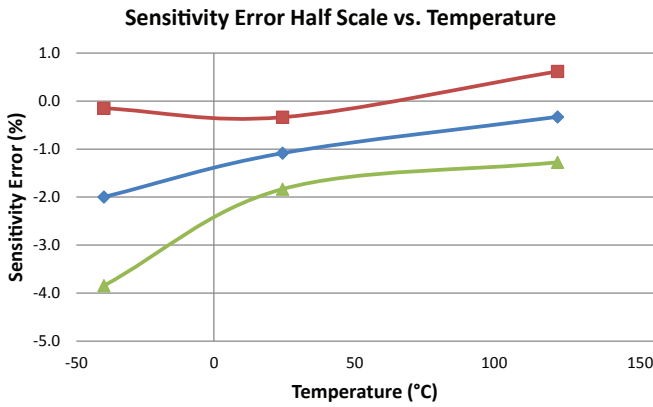
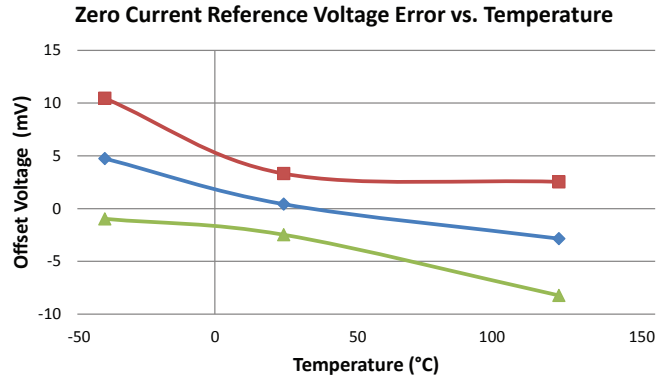
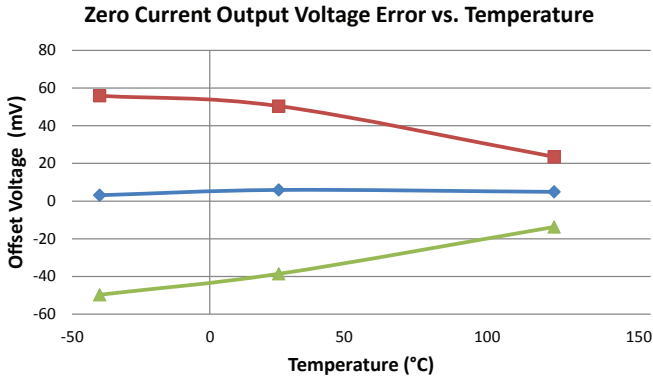

■ +3 Sigma
 ◆ Average
 ▲ -3 Sigma

xKLCTR-40AB Key Parameters

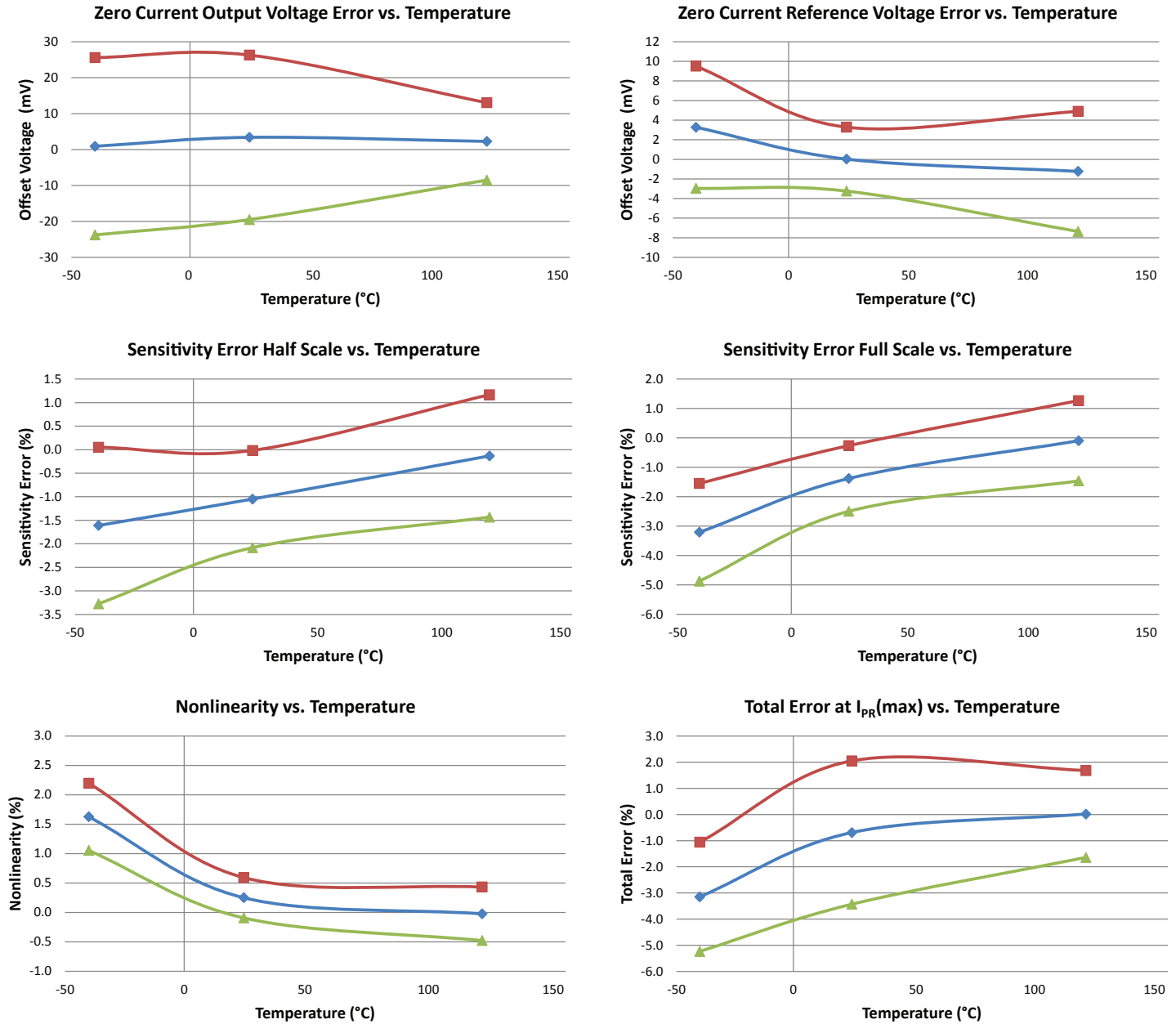

■ +3 Sigma
 ◆ Average
 ▲ -3 Sigma

xKLCTR-50AB Key Parameters

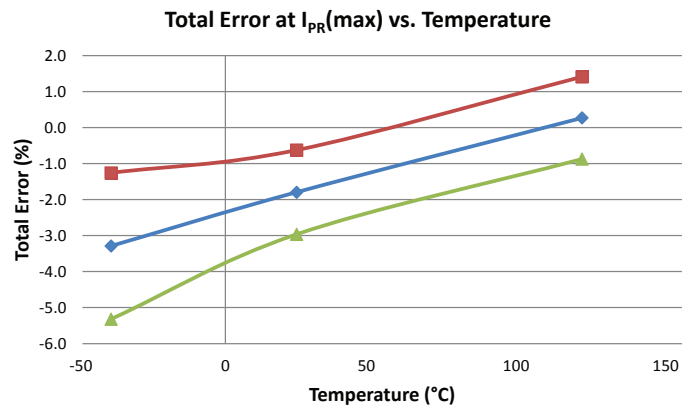
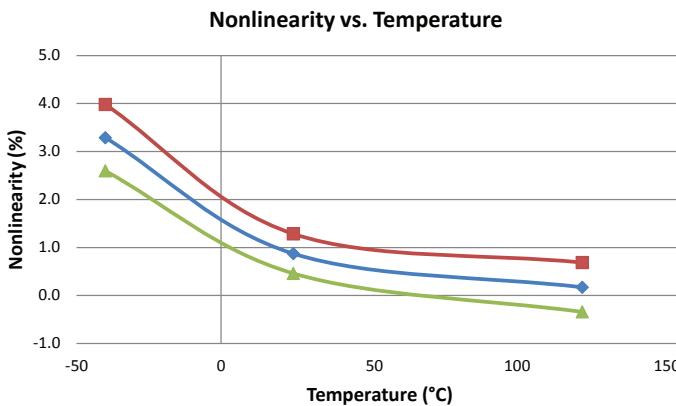
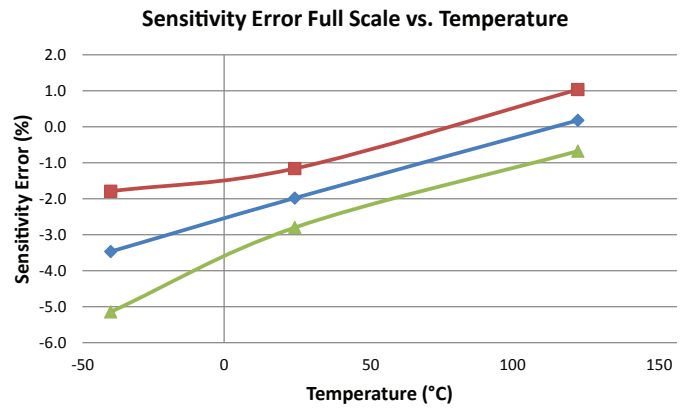
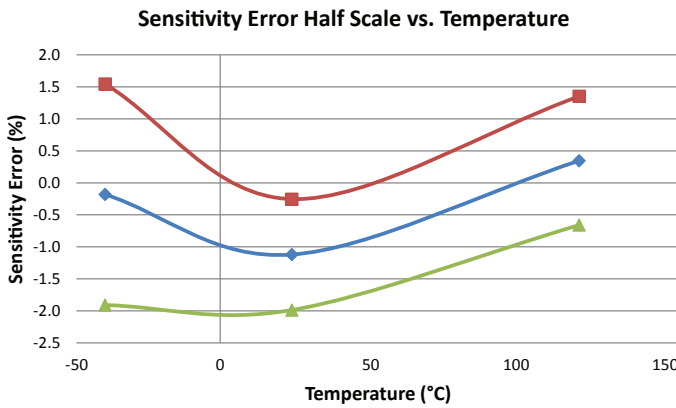
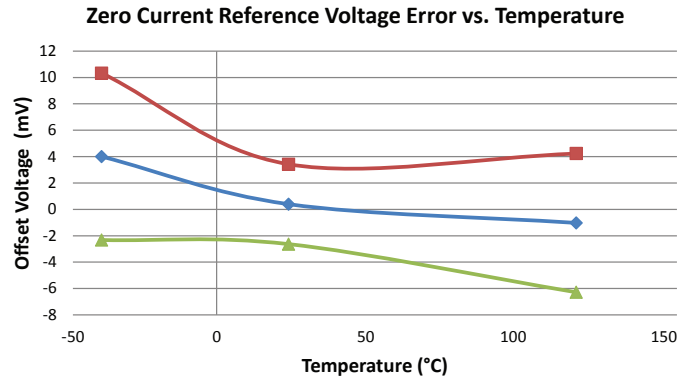
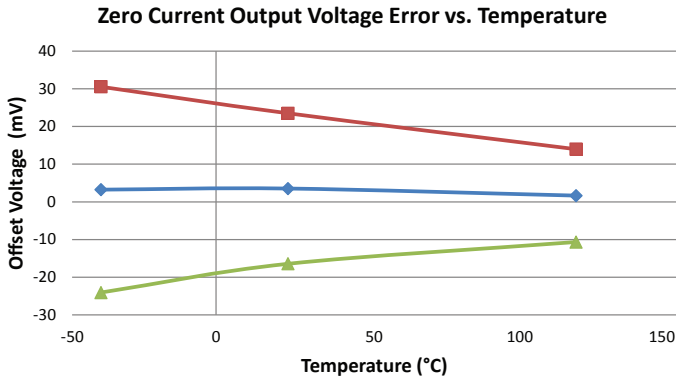

■ +3 Sigma
 ◆ Average
 ▲ -3 Sigma

DEFINITIONS OF ACCURACY CHARACTERISTICS

Sensitivity (Sens). The change in sensor IC output in response to a 1 A change through the primary conductor. The sensitivity is the product of the magnetic circuit sensitivity (G/A) (1 G = 0.1 mT) and the linear IC amplifier gain (mV/G). The linear IC amplifier gain is programmed at the factory to optimize the sensitivity (mV/A) for the full-scale current of the device.

Nonlinearity (E_{LIN}). The nonlinearity is a measure of how linear the output of the sensor IC is over the full current measurement range. The nonlinearity is calculated as:

$$E_{LIN} = \left\{ 1 - \frac{V_{IOUT}(I_R(max)) - V_{IOUT(Q)}}{2 \cdot V_{IOUT}(I_R(max)/2) - V_{IOUT(Q)}} \right\} \cdot 100(\%)$$

Zero Current Output Voltage ($V_{IOUT(Q)}$). The output of the sensor when the primary current is zero. For a unipolar supply voltage, it nominally remains at 2.5 V for a bidirectional device. Variation in $V_{IOUT(Q)}$ can be attributed to the resolution of the Allegro linear IC quiescent voltage trim and thermal drift.

Offset Voltage (V_{OE}). The deviation of the device output from its ideal quiescent value of 2.5 V due to nonmagnetic causes. To convert this voltage to amperes, divide by the device sensitivity, Sens.

Total Output Error (E_{TOT}). The difference between the current measurement from the sensor IC and the actual current (I_P), relative to the actual current. This is equivalent to the difference between the ideal output voltage and the actual output voltage, divided by the ideal sensitivity, relative to the current flowing through the primary conduction path:

$$E_{TOT}(I_P) = \frac{V_{IOUT_IDEAL}(I_P) - V_{IOUT}(I_P)}{Sens_{IDEAL} \times I_P} \cdot 100 (\%)$$

The Total Output Error incorporates all sources of error and is a function of I_P . At relatively high currents, E_{TOT} will be mostly due to sensitivity error, and at relatively low currents, E_{TOT} will be mostly due to Offset Voltage (V_{OE}). In fact, at $I_P = 0$, E_{TOT} approaches infinity due to the offset. This is illustrated in Figure 1 and Figure 2. Figure 1 shows a distribution of output voltages versus I_P at 25°C and across temperature. Figure 2 shows the corresponding E_{TOT} versus I_P .

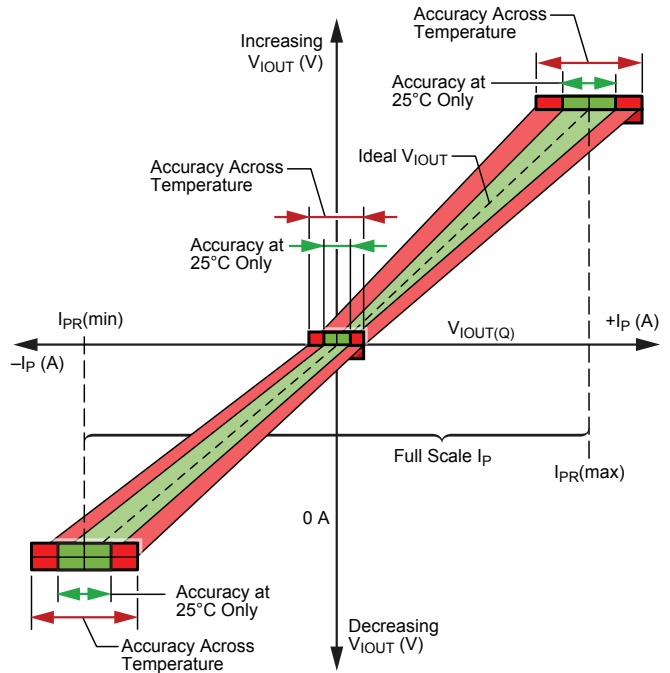

Figure 1: Output Voltage versus Sensed Current

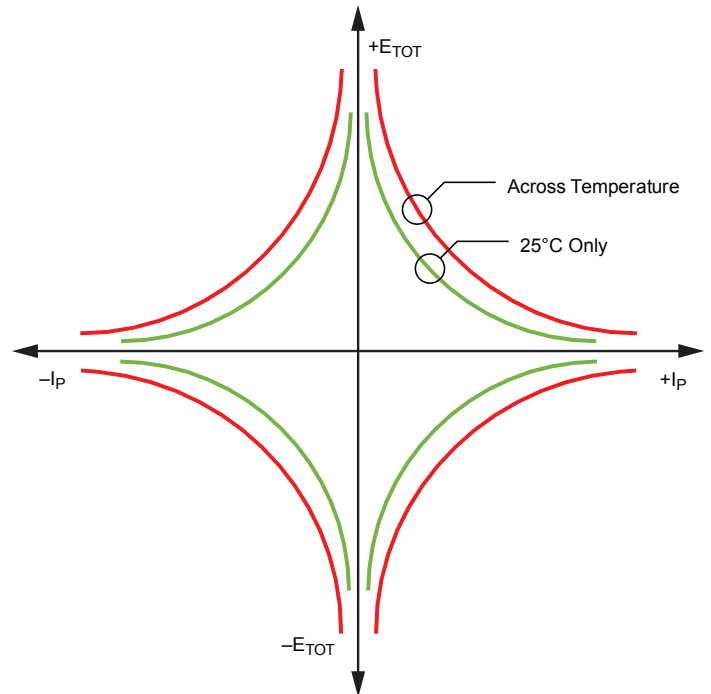

Figure 2: Total Output Error versus Sensed Current

Power Supply Rejection Ratio (PSRR). The ratio of the change on V_{IOUT} or V_{ZCR} to a change in V_{CC} in dB.

$$PSRR = 20 \log_{10} \left(\left| \frac{\Delta V_{CC}}{\Delta V_{IOUT}} \right| \right)$$

Sensitivity Power Supply Rejection Ratio (SPSRR). The ratio of the percent change in sensitivity from the sensitivity at 5 V to the percent change in V_{CC} in dB.

$$SPSRR (V_{CC}) = 20 \log_{10} \left(\left| \frac{Sens_{V_{CCN}} \times (V_{CC} - 5 \text{ V})}{[Sens_{V_{CC}} - Sens_{5V}] \times 5 \text{ V}} \right| \right)$$

An SPSRR value of 15 dB means that a ten percent change in V_{CC} (going from 5 to 5.5 V, for example) results in around a 1.75 percent change in sensitivity.

Offset Power Supply Rejection Ratio (OPSRR). The ratio of the change in offset to a change in V_{CC} in dB.

$$OPSRR = 20 \log_{10} \left(\left| \frac{\Delta V_{CC}}{\Delta V_{OE}} \right| \right)$$

An OPSRR value of 30 dB means that a 500 mV change in V_{CC} (going from 5 to 5.5 V, for example) results in around 15 mV of change in the offset.

APPLICATION INFORMATION

Impact of External Magnetic Fields

The ACS730 works by sensing the magnetic field created by the current flowing through the package. However, the sensor cannot differentiate between fields created by the current flow and external magnetic fields. This means that external magnetic fields can cause errors in the output of the sensor. Magnetic fields which are perpendicular to the surface of the package affect the output of the sensor, as it only senses fields in that one plane. The error in Amperes can be quantified as:

$$\text{Error (A)} = \frac{B}{MCF}$$

where B is the strength of the external field perpendicular to the surface of the package in gauss (G), and MCF is the magnetic coupling factor in gauss/amperes (G/A). Then, multiplying by the sensitivity of the part (Sens) gives the error in mV seen at the output.

For example, an external field of 1 gauss will result in around 0.1 A of error. If the ACS730KLCTR-20AB, which has a nominal sensitivity of 100 mV/A, is being used, that equates to 10 mV of error on the output of the sensor.

External Field (Gauss)	Error (A)	Error (mV)		
		20B	40B	50B
0.5	0.05	5	2.5	2
1	0.1	10	5	4
2	0.2	20	10	8

Estimating Total Error vs. Sensed Current

The Performance Characteristics tables give distribution values (± 3 sigma) for Total Error at $I_p(\text{max})$ and $I_p(\text{half})$; however, one often wants to know what error to expect at a particular current. This can be estimated by using the distribution data for the components of Total Error, Sensitivity Error, and Offset Voltage. The ± 3 sigma value for Total Error (E_{TOT}) as a function of the sensed current (I_p) is estimated as:

$$E_{TOT}(I_p) = \sqrt{E_{SENS}^2 + \left(\frac{100 \times V_{OE}}{Sens \times I_p}\right)^2}$$

Here, E_{SENS} and V_{OE} are the ± 3 sigma values for those error terms. If there is an average offset voltage, then the average Total Error is estimated as:

$$E_{TOT_{AVG}}(I_p) = E_{SENS_{AVG}} + \frac{100 \times V_{OE_{AVG}}}{Sens \times I_p}$$

The resulting total error will be a sum of E_{TOT} and $E_{TOT_{AVG}}$. Using these equations and the 3 sigma distributions for Sensitivity Error and Offset Voltage, the Total Error versus sensed current (I_p) is below for the ACS730KLCTR-20AB. As expected, as the sensed current (I_p) approaches zero, the error in percent goes towards infinity due to division by zero (refer to Figure 3).

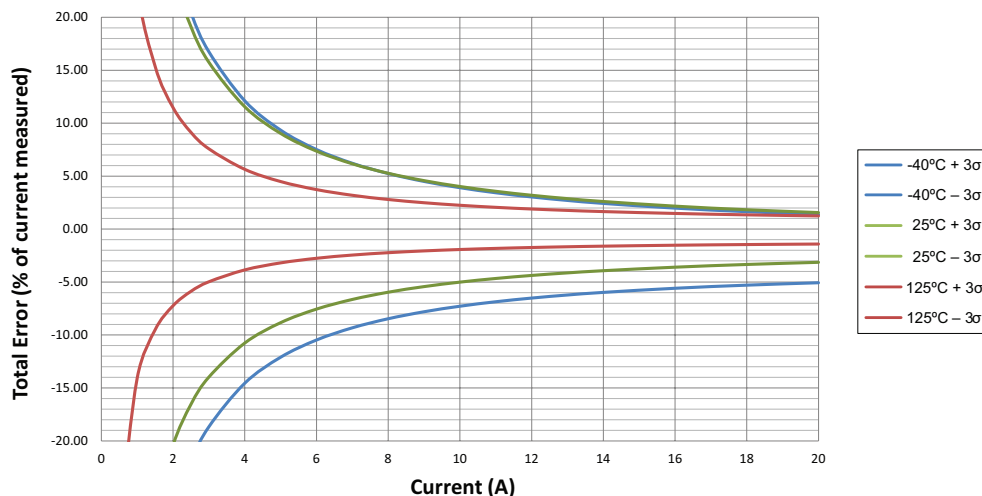

Figure 3: Predicted Total Error as a Function of the Sensed Current for the ACS730KLCTR-20AB

DEFINITIONS OF DYNAMIC RESPONSE CHARACTERISTICS

Power-On Time (t_{PO}). When the supply is ramped to its operating voltage, the device requires a finite time to power its internal components before responding to an input magnetic field. Power-On Time, t_{PO} , is defined as the time it takes for the output voltage to settle within $\pm 10\%$ of its steady-state value under an applied magnetic field, after the power supply has reached its minimum specified operating voltage, $V_{CC(min)}$, as shown in the chart at right.

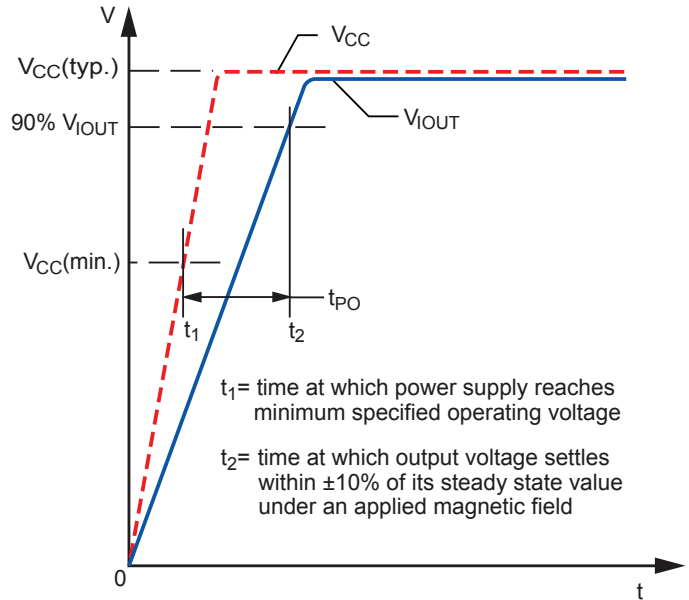

Figure 3: Power-On Time (t_{PO})

Rise Time (t_r). The time interval between a) when the sensor reaches 10% of its full-scale value, and b) when it reaches 90% of its full scale value.

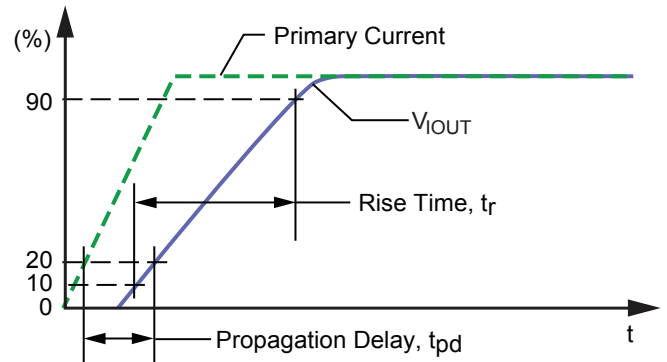

Figure 4: Rise Time (t_r) and Propagation Delay (t_{pd})

Response Time ($t_{RESPONSE}$). The time interval between a) when the sensed input current reaches 90% of its final value, and b) when the sensor output reaches 90% of its full-scale value.

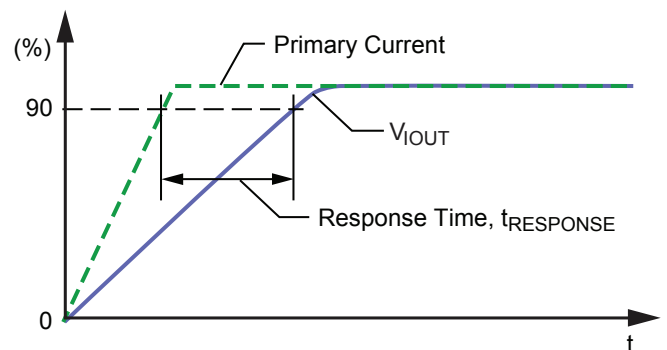

Figure 5: Response Time ($t_{RESPONSE}$)

PACKAGE OUTLINING DRAWING

For Reference Only – Not for Tooling Use

(Reference MS-012AA)

Dimensions in millimeters – NOT TO SCALE

Dimensions exclusive of mold flash, gate burrs, and dambar protrusions
Exact case and lead configuration at supplier discretion within limits shown

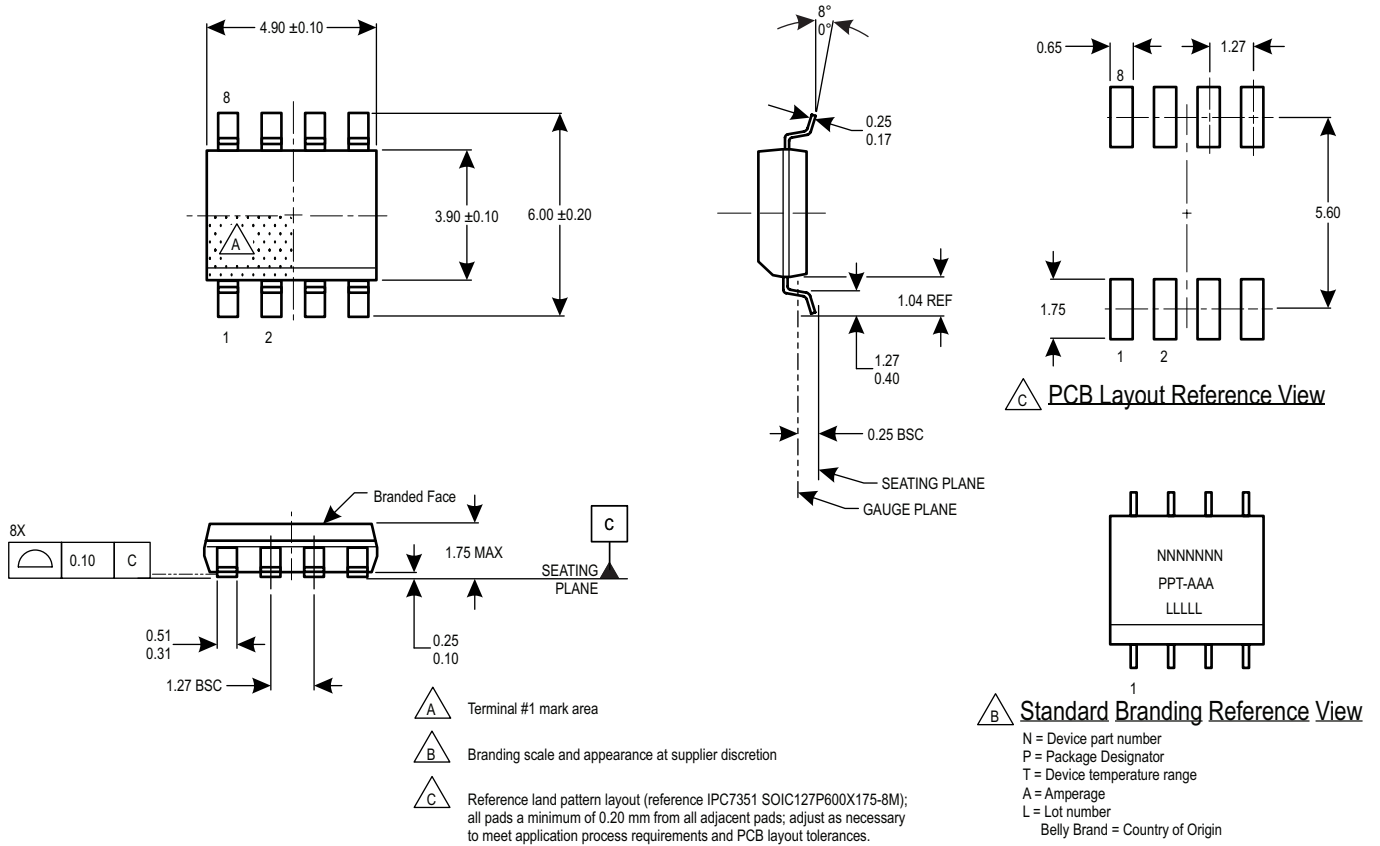

Figure 6: Package LC, 8-Pin SOICN

Revision History

Number	Date	Description
–	February 29, 2016	Initial release
1	August 19, 2016	Updated Isolation Characteristics table and added Frequency Response charts
2	February 28, 2017	Updated Absolute Maximum Ratings table
3	August 29, 2017	Added “-40AU” and “-80AU” product options; updated Isolation Characteristics table.

Copyright ©2017, Allegro MicroSystems, LLC

Allegro MicroSystems, LLC reserves the right to make, from time to time, such departures from the detail specifications as may be required to permit improvements in the performance, reliability, or manufacturability of its products. Before placing an order, the user is cautioned to verify that the information being relied upon is current.

Allegro’s products are not to be used in any devices or systems, including but not limited to life support devices or systems, in which a failure of Allegro’s product can reasonably be expected to cause bodily harm.

The information included herein is believed to be accurate and reliable. However, Allegro MicroSystems, LLC assumes no responsibility for its use; nor for any infringement of patents or other rights of third parties which may result from its use.

For the latest version of this document, visit our website:

www.allegromicro.com



X-ON Electronics

Largest Supplier of Electrical and Electronic Components

Click to view similar products for [Industrial Current Sensors](#) category:

Click to view products by [Allegro](#) manufacturer:

Other Similar products are found below :

[CSNS181](#) [S28S500D24ZM](#) [CSNS300M-001](#) [L05Z800S15](#) [5SHT-151-E](#) [5SHT-500-E](#) [T60404-B4658-X030](#) [T60404-B4658-X029](#) [SAO-Q1N](#) [SAO-Q2N](#) [CSNS300F-002](#) [CSCA0075A000U12J01](#) [SAO-S1N](#) [L34S1T5D15T](#) [L34S500D15T](#) [L34S1T0D15T](#) [CSNS300M-500](#) [LA200-P](#) [ACS724LLCTR-10AB-T](#) [ACS711KEXLT-15AB-T](#) [20310200202](#) [LCS10T12](#) [20320500101](#) [20310508201](#) [CCT354571-300-24-00](#) [LCSC10T12](#) [20320300101](#) [S29S1T0D24Z](#) [CCT272440-80-10-02](#) [DCSA20](#) [S21S180D15JN](#) [L31S300S05FS](#) [T60404-N4644-X021](#) [ECSL61AH](#) [ISB-300-A-802](#) [ISB-300-A-604](#) [ISB-175-A-802](#) [ISB-175-A-800](#) [ISB-175-A-604](#) [ISB-100-A-802](#) [LPMG12](#) [ECS41BC](#) [ECS41BD](#) [SAO-S5N](#) [DCSA50](#) [ECS21BC](#) [ACS726LLFTR-20B-T](#) [A-CS010B](#) [A-CS050B](#) [A-CS100B](#)