



承 認 書

SPECIFICATION FOR APPROVAL

客 戶 名 稱

Customer Name

產 品 名 稱

5050 全彩

Product Name

產 品 型 號

2SC5050VGB0WR003

Product No

客 戶 料 號

Customer Part No

適 用 機 型

Model No

日 期

2018-05-18

Date

Customer Approved Signatures:

AUTHORIZED	CHECK	VALIDATED

Approved Signatures:

APPROVED	CHECK	PREPARED
羅俊仁	陸壯樹	劉雲珍

Tel/Fax:86-755-6186 5256/ 6186 5258

E-mail: sales@brightekopto.com

Address 工廠:深圳市寶安區松崗鎮潭頭西部工業園 B7 棟

總部:臺灣桃園縣桃園市春日路 1492 號 7 樓





Part No: 2SC5050VGB0WR003

Characters

- § 5.0mm×5.0mm SMT LED , 1.6mm THICKNESS.
- § LOW POWER CONSUMPTION.
- § VIEWING ANGLE 120°.
- § VARIOUS COLORS AND LENS TYPES AVAILABLE.
- § PACKAGE:1000 PCS/REEL.

ITEM		MATERIALS
Resin(Mold)		Silicone
Lens Color		Water Clear
Dice	Red	InGaInP
	Green	InGaN
	Blue	InGaN

Absolute Maximum Ratings (Ta=25°C)

Item	Symbol	Value			Unit
		Red	Green	Blue	
Power Dissipation	PD	100	80	80	mW
DC Forward Current	IF	30	30	30	mA
Pulse Forward Current	IFP	100	100	100	mA
Reverse Voltage	VR	5	5	5	V
Operating Temperature	Topr	-40 ~ +80			°C
Storage Temperature	Tstg	-40 ~ +85			°C

※Duty 1/10, Pulse Width 0.1ms.

■Please refer to IF-Ta diagram of curves for the temperature during application

**Electrical-Optical Characteristics (Ta=25°C)**

Parameter	Symbol		Value			Unit	Test condition
			Min.	Typ.	Max.		
Forward Voltage	VF	R	1.8	---	2.4	V	If=20mA
		G	2.8	---	3.6		
		B	2.8	---	3.6		
Wavelength	λd	R	617	---	629	nm	
		G	518	---	530		
		B	464	---	473		
Luminous intensity	IV	W	2900	---	5050	mcd	If=20mA*3
Chromaticity Coordinates	x		---	0.215	---	---	If=20mA*3
	y		---	0.245	---		
Reverse Current	Ir		---	---	10	μA	Vr=5V
Viewing angle	2 θ /2		---	120	---	Deg	If=20mA

1.Luminous intensity (IV) $\pm 10\%$, Forward Voltage (VF) $\pm 0.1V$, Wavelength(λd) $\pm 1.0nm$

2.IS standard testing



Range of Bins

■white

Bin	1	2	3
IV(mcd)	2900-3500	3500-4250	4250-5050

Color Coordinate Comparison

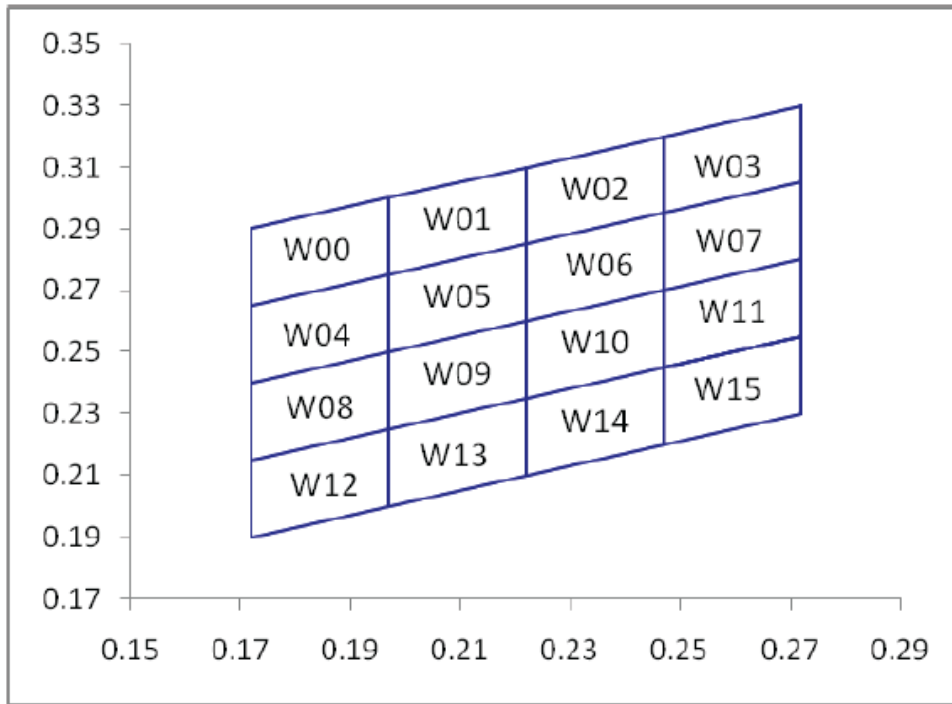

Bin	x	y	Bin	x	y	Bin	x	y	Bin	x	y
W00	0.1720	0.2650	W01	0.1970	0.2750	W02	0.2220	0.2850	W03	0.2470	0.2950
	0.1720	0.2900		0.1970	0.3000		0.2220	0.3100		0.2470	0.3200
	0.1970	0.3000		0.2220	0.3100		0.2470	0.3200		0.2720	0.3300
	0.1970	0.2750		0.2220	0.2850		0.2470	0.2950		0.2720	0.3050
W04	0.1720	0.2400	W05	0.1970	0.2500	W06	0.2220	0.2600	W07	0.2470	0.2700
	0.1720	0.2650		0.1970	0.2750		0.2220	0.2850		0.2470	0.2950
	0.1970	0.2750		0.2220	0.2850		0.2470	0.2950		0.2720	0.3050
	0.1970	0.2500		0.2220	0.2600		0.2470	0.2700		0.2720	0.2800
W08	0.1720	0.2150	W09	0.1970	0.2250	W10	0.2220	0.2350	W11	0.2470	0.2450
	0.1720	0.2400		0.1970	0.2500		0.2220	0.2600		0.2470	0.2700
	0.1970	0.2500		0.2220	0.2600		0.2470	0.2700		0.2720	0.2800
	0.1970	0.2250		0.2220	0.2350		0.2470	0.2450		0.2720	0.2550
W12	0.1720	0.1900	W13	0.1970	0.2000	W14	0.2220	0.2100	W15	0.2470	0.2200
	0.1720	0.2150		0.1970	0.2250		0.2220	0.2350		0.2470	0.2450
	0.1970	0.2250		0.2220	0.2350		0.2470	0.2450		0.2720	0.2550
	0.1970	0.2000		0.2220	0.2100		0.2470	0.2200		0.2720	0.2300



Outline Dimensions

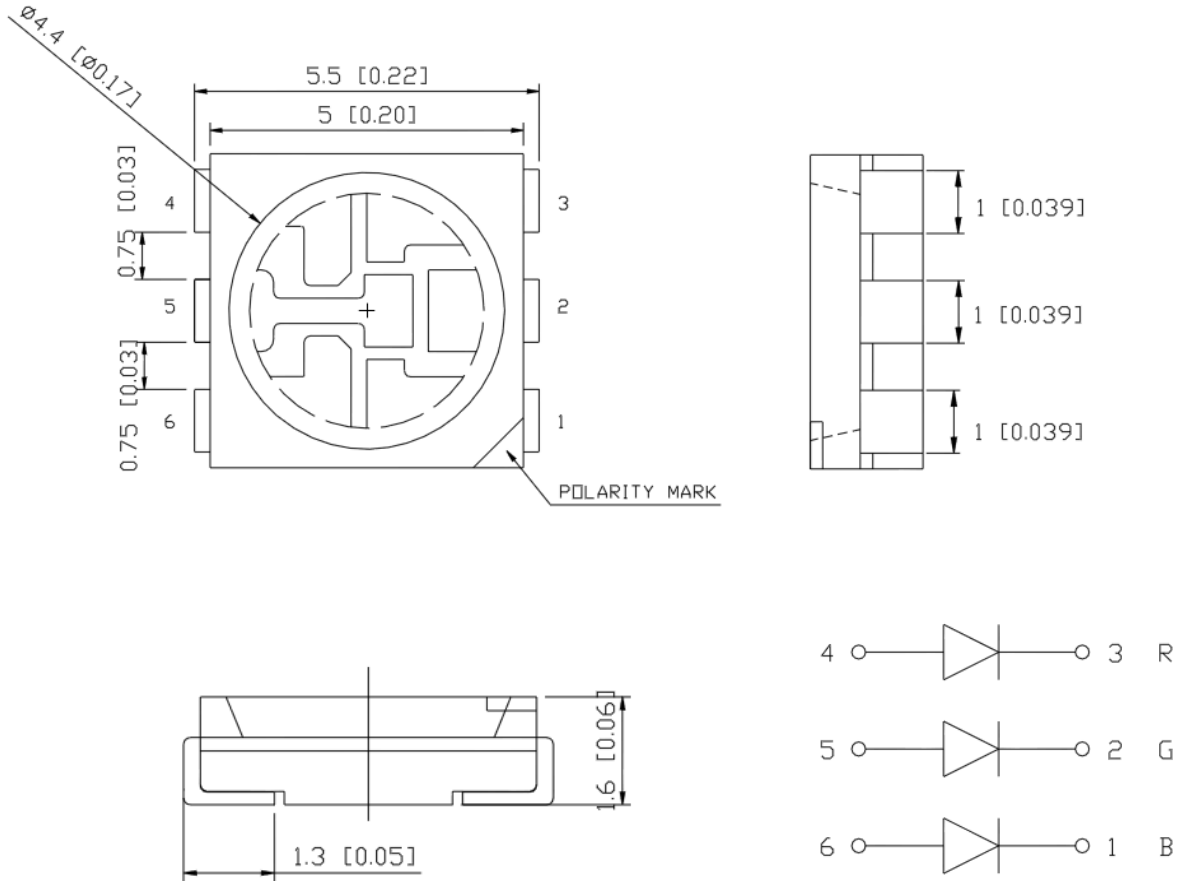

RECOMMEND PAD LAYOUT

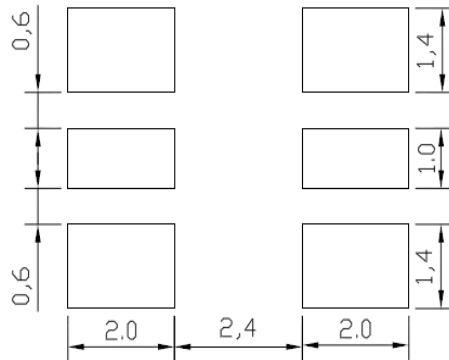

All dimensions are in millimeters.
 Tolerance is ± 0.1 mm unless other specified
 Specifications are subject to change without notice.



Electrical characteristic graph

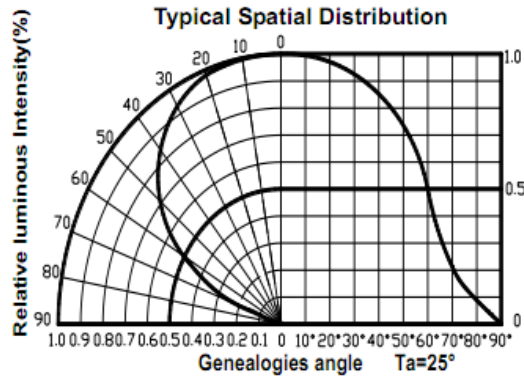
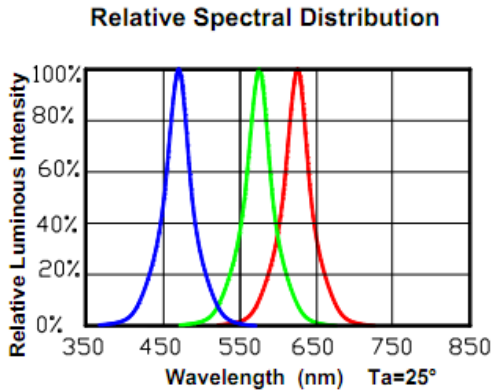

Relative Luminous Flux .Current Ta=25

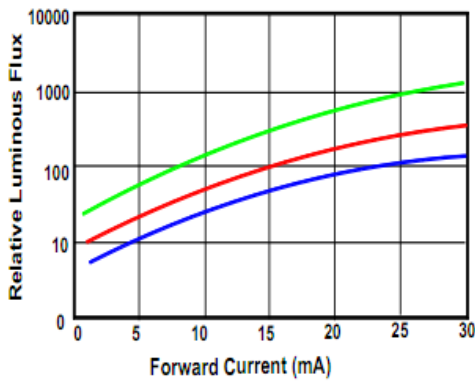

Relative Luminous Flux .Ambient Temperature

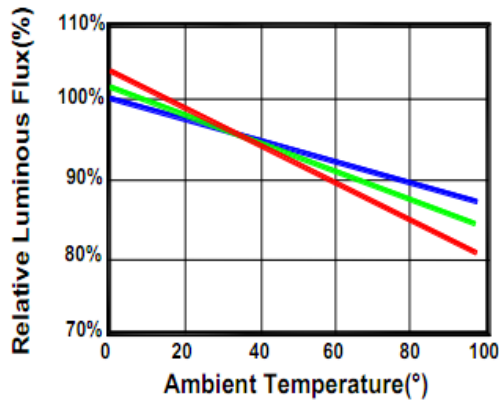

Electrical Characteristics

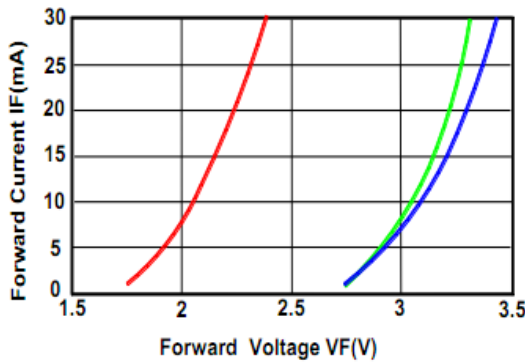

Thermal Design

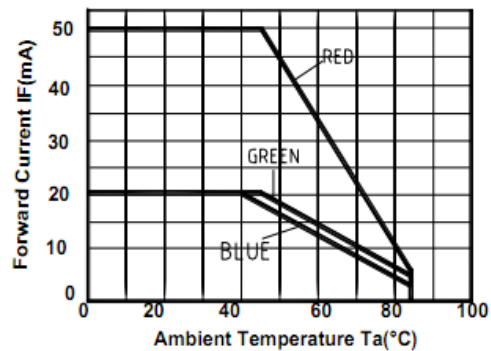

Forward Voltage Temperature

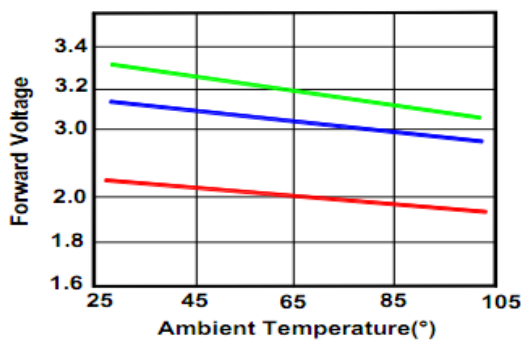

Wavelength and current

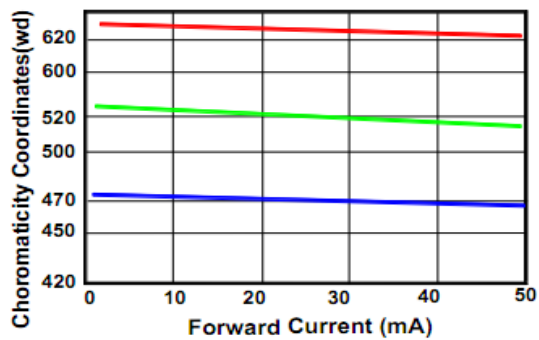



SMD 類物料存儲及使用說明

一、存儲說明：

- (1) LED 使用密封防潮靜電袋包裝，並附有乾燥劑，出貨前均有烘烤除濕，並抽真空包裝。開封前，產品須存放在溫度 $25\pm 5^{\circ}\text{C}$ ，相對濕度 40-70%RH 環境中。
- (2) 禁止把倒放出來的乾燥劑置於潮濕的地方，所使用的乾燥劑應立即投入所放置的產品中裡面去，並立即密封好產品的封口，餘下的乾燥劑就用繩子紮緊袋口，並封好外箱，避免空氣進入。
- (3) 乾燥劑在完成密封情況下，自生產日期起開始計算，有效期為 6 個月。
- (4) 開封後，產品應在 24 小時內使用完；如未能使用完，餘料須放置於溫度 $25\pm 5^{\circ}\text{C}$ ，相對濕度 40-70%RH 環境中。濕敏等級較高的產品建議上線前先進行 $60^{\circ}\text{C}/12\text{H}$ 烘烤除濕。(建議工作環境為溫度不高於 30°C ，濕度不高於 60%RH。)
- (5) 對於尚未焊接的 LED，如果包裝失效或者產品沒有符合以上有效儲存條件，使用前必須要進行烘烤處理(卷帶包裝產品烘烤條件： 60°C ，持續時間 12 小時，烘烤時包裝袋要取下，放置卷盤的產品烘烤要保證熱風循環，烤箱必須打開排濕口)。
- (6) 生產日期在三個月內，LED 使用前烘烤 $60^{\circ}\text{C}/24$ 小時；生產日期超過三個月至一年內的 LED 使用前烘烤條件： $60^{\circ}\text{C}/36\sim 48$ 小時。
- (7) 如進料前，已發現防潮靜電箔袋拆封、破損、穿孔，可及時退回我司重新進行除濕。在包裝拆封後，對未用完的產品需保存於密封、乾燥的環境下，避免採用透明膠帶、訂書釘進行簡單的封口。如果產品未作嚴格的密封防潮保存，則再次使用前必須進行高溫除濕。

二、使用說明：

- (1) 回流焊接溫度及時間請參照對應產品規格書。LED 不宜進行兩次或兩次以上的回流焊接。
- (2) 不建議將 LED 貼裝在彎曲的線路板上。焊接時避免快速冷卻，在 LED 焊接冷卻過程中避免任何形式的機械力或過度的震動，焊接後不要彎曲線路板。
- (3) 完成焊接的 LED 不宜進行返修作業。如不可避免，採用雙頭烙鐵，但事先應確認返修是否會對 LED 的特性產生破壞。

回流焊曲線圖：

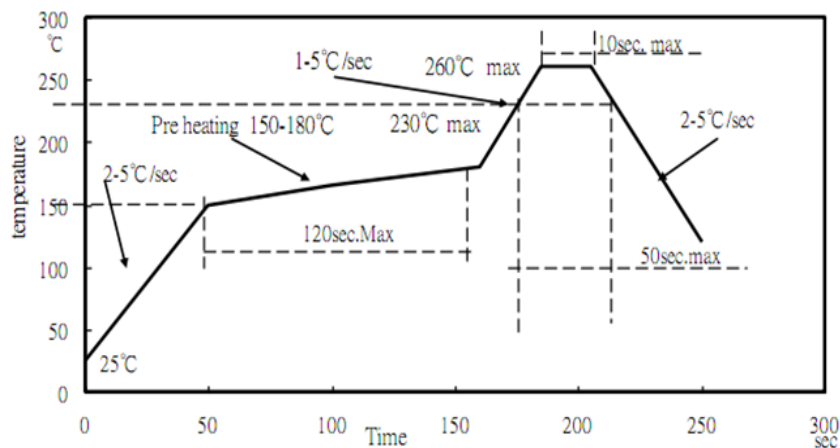

1. 我們建議的回流焊溫度為 $240^{\circ}\text{C}\pm 5^{\circ}\text{C}$ ，最高的焊接溫度要控制在 260°C 以內。
2. 當產品在處在高溫狀態中時不要對其矽膠施加壓力。
3. 回流焊的次數應不超過 1 次。

三、靜電防護：

LED 是靜電敏感電子元器件，應採取各種措施避免靜電，諸如在使用過程中戴靜電手環或防靜電手套。所有的裝置、設備儀器應適當的接地。建議在貼裝 LED 時預防機器設備的浪，建議對組裝後的 LED 產品進行測試檢查 LED 是否受到靜電的破壞，白光或藍光 LED 確認方法為(參考)：1mA 或 2.5V/單顆晶片不能點亮或同等條件下亮度較其他 LED 明顯偏暗為缺陷品。

四、清潔清洗：

建議使用異丙醇來清潔 LED，如果要採用其他溶劑清潔，一定要確保此溶劑不會對環氧、有機矽、矽膠、支架鍍銀層等產生影響。不建議使用超聲波清洗以免對 LED 造成損傷。若不可避免，清洗前請事先進行預測試，以確認是否對 LED 造成不良影響或潛在性隱患。



Test circuit and handling precautions

1. Test Circuit

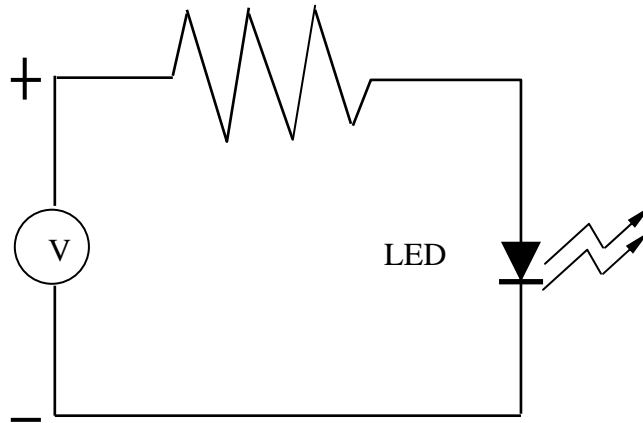

2. Handling Precautions

1. Over-current-proof

Customer must apply resistors for protection; otherwise slight voltage shift will cause big current change (Burn out will happen).

2. Storage

2.1 It is recommended to store the products in the following conditions:

Humidity: 60% R.H. Max.

Temperature: 5°C~30°C (41°F~86°F)

2.2 Shelf life in sealed bag: 12 month at <5°C~30°C and <60% R.H. after the package is

Opened, the products should be used within four week or they should be keeping to stored at $\leq 20\%$ R.H. with zip-lock sealed.

3. Baking

It is recommended to baking before soldering when the pack is unsealed after 24hrs. The

Conditions are as followings:

3.1 60±3°C x 6hrs and <5%RH, for reel

3.2 125±3°C x 2hrs, for single LED

It shall be normal to see slight color fading of carrier (light yellow) after baking in process



Precautions

1. Abnormal situation caused by improper setting of collet

To choose the right collet is the key issue in improving the product's quality. LED is different from other electronic components, which is not only about electrical output but also for optical output. This characteristic made LED more fragile in the process of SMT. If the collet's lowering down height is not well set, it will bring damage to the gold wire at the time of collet's picking up and loading which will cause the LED fail to light up, light up now and then or other quality problems

2. How to choose the collet

During SMT, please choose the collet that has larger outer diameter than the lighting area of lens, in case that improper position of collet will damage the gold wire inside the LED. Different collets fit for different products, please refer to the following pictures cross out

Outer diameter of collet should be larger than the lighting area

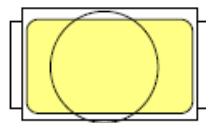

Picture 1(✓)

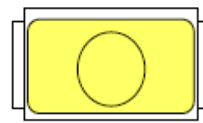

Picture 2(X)

3. Other points for attention

A. No pressure should be exerted to the epoxy shell of the SMD under high temperature. B. Do not scratch or wipe the lens since the lens and gold wire inside are rather fragile and cross out easy to break. C. LED should be used as soon as possible when being taken out of the original package, and should be stored in anti-moisture and anti-ESD package.

4. This usage and handling instruction is only for your reference.

5. Handle the component along the side surface by using forceps or appropriate tools; do not directly touch or Handle the silicone lens surface, it may damage the internal circuitry.

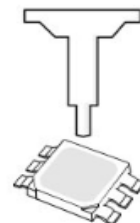



6. Do not stack together assembled PCBs containing LEDs. Impact may scratch the silicone lens or damage the internal circuitry

7. Not suitable to operate in acidic environment, PH<7.

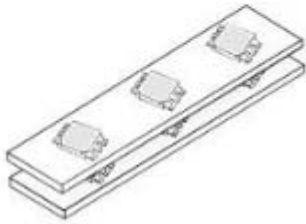

8. LED operating environment and sulfur element composition cannot be over 100PPM in the LED mating usage material.

9. When we need to use external glue for LED application products, please make sure that the external glue matches the LED packaging glue. Additionally, as most of LED packaging glue is silica gel, and it has strong Oxygen permeability as well as strong moisture permeability; in order to prevent external material from getting into the inside of LED, which may cause the malfunction of LED, the single content of Bromine element is required to be less than 900PPM, the single content of Chlorine element is required to be less than 900PPM, the total content of Bromine element and Chlorine element in the external glue of the application products is required to be less than 1500PPM.

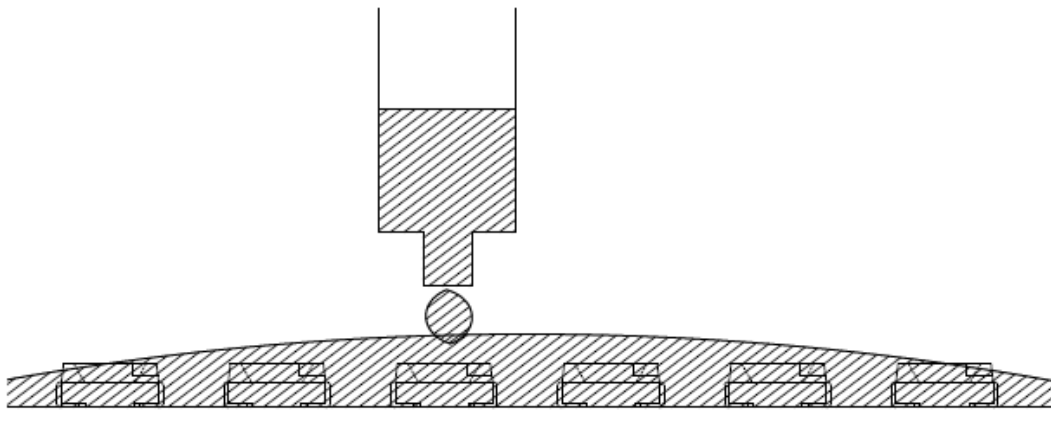



5050Mult-Color High Performance SMD Top LEDs Packaging Specificat

● Dimensions of Reel (Unit: mm)

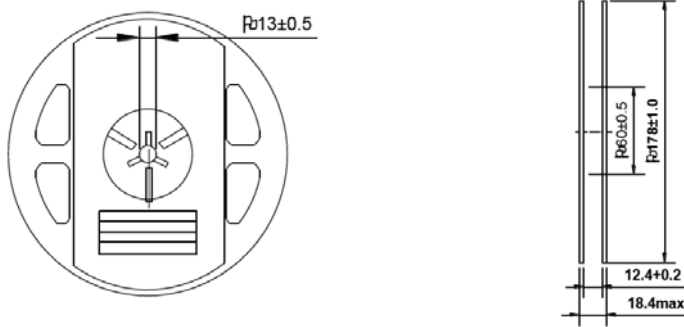

● Dimensions of Tape (Unit: mm)

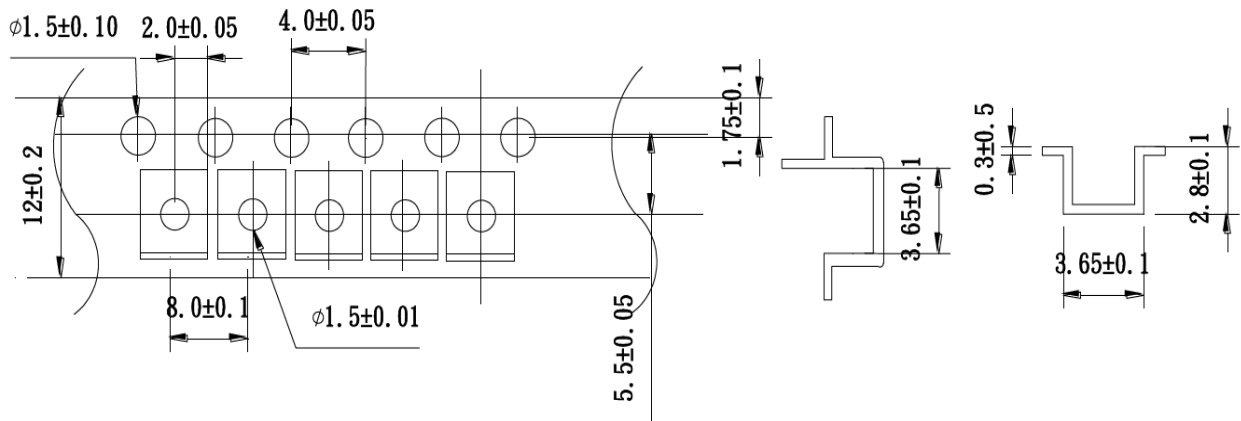

● Arrangement of Tape

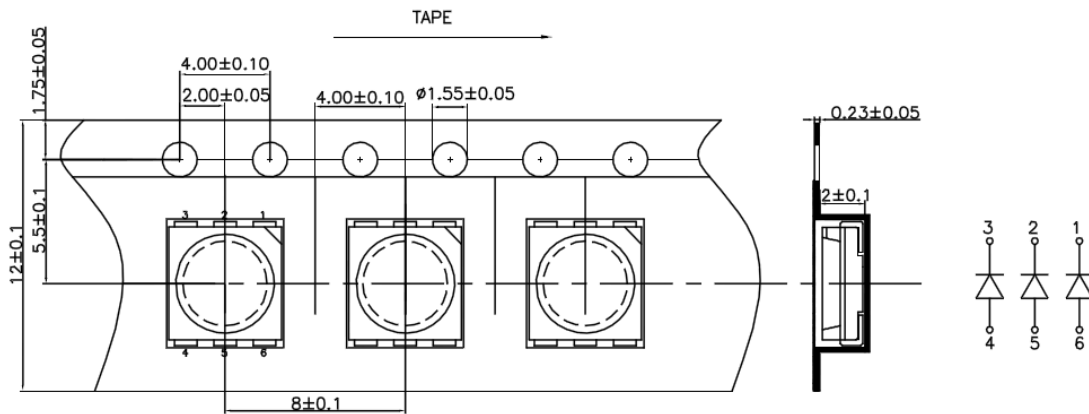

NOTES

1. Empty component pockets are sealed with top cover tape;
2. The maximum number of missing lamps is two.
3. 1,000pcs/Reel



5050Mult-Color High Performance SMD Top LEDs Packaging Specificat

● Packaging specifications

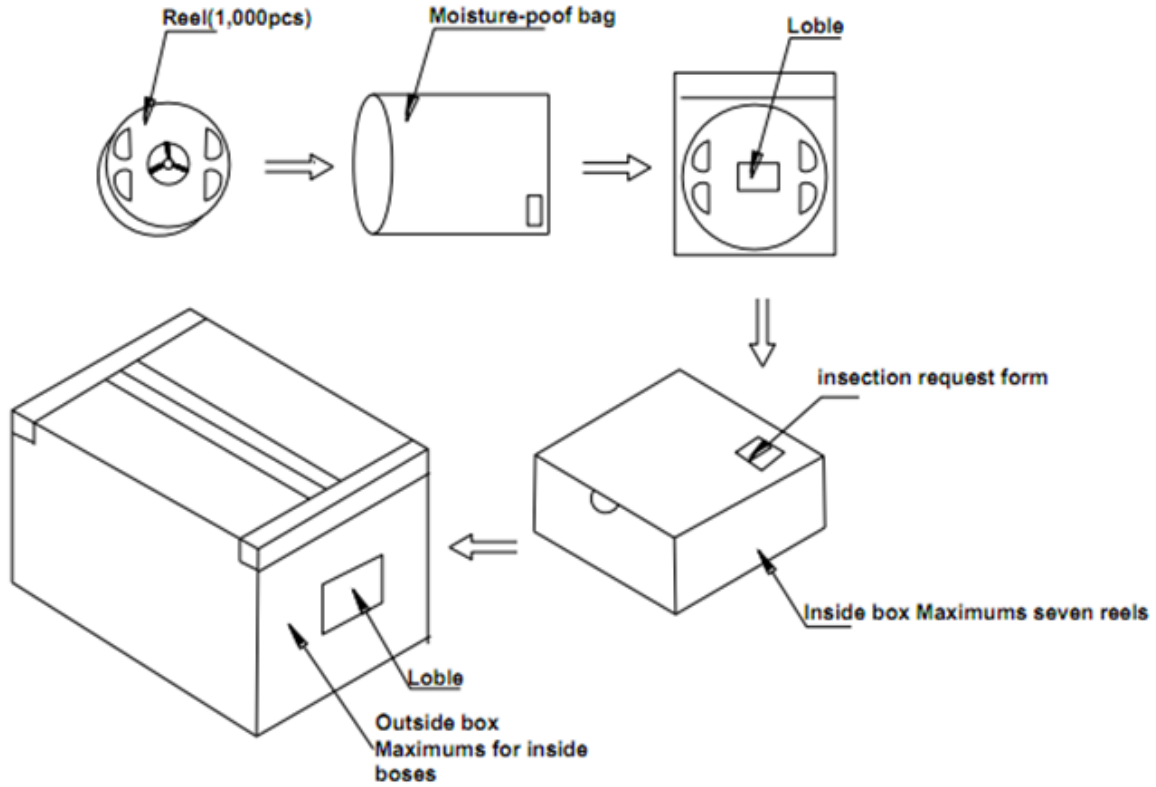

NOTES:

Reeled products (numbers of products are 1,000pcs) packed in a seal off moisture-proof bag along with a desiccant one by one, Seven moisture-proof bag of maximums (total maximum number of products are 10,000pcs) packed in an inside box (size: about 238mm x about 194mm x about 102mm) and four inside boxes of maximums are put in the outside box (size: about 410mm x about 254mm x about 229mm) Together with buffer material, and it is packed. (Part No., Lot No., quantity should appear on the label on the moisture-proof bag, part No. And quantity should appear on theinsection request form on the cardboard box.) .

X-ON Electronics

Largest Supplier of Electrical and Electronic Components

Click to view similar products for [Standard LEDs - SMD category](#):

Click to view products by [Brightek manufacturer](#):

Other Similar products are found below :

[LTST-C19GD2WT](#) [LTST-N683GBEW](#) [597-3006-607F](#) [597-3403-607F](#) [LTW-K140SZR40](#) [LTW-M140ZVS](#) [598-8110-100F](#) [598-8170-100F](#)
[598-8610-202F](#) [7012X7](#) [AAAF5060QBFSEEZGS](#) [12-22SURSYGC/S530-A3/E2/TR8](#) [1383SURT/S530-A3/TR1\(R\)](#) [APT1608QGW](#)
[EASV1803BA0](#) [SML310BATT86](#) [SML-512VWT86A](#) [SML-LX0606SISUGC/A](#) [SML-LXL1307SRC-TR](#) [SML-LXR851SIUPGUBC](#)
[LT1ED53A](#) [17-21/G6C-FM1N2B/3T](#) [FAT801-S](#) [SSL-LXA227IC-TR31A](#) [AM27ZGC03](#) [APB3025SGNC](#) [APHK1608VGCA](#) [APT2012QGW](#)
[CLMVC-FKA-CA1E1L81BB7C3C3](#) [CLYBA-FKA-CFHHL9BBB7A363](#) [CMD11504UR](#) [LTW-020ZDCG](#) [LTW-21TS5](#) [LTW-K140SZR30](#)
[HSMY-C177](#) [UYGT801-S](#) [KVH1C100MF6R](#) [42-21SYGC/S530-E1/TR8](#) [YGFR411-H](#) [597-2311-402F](#) [597-2712-602F](#) [5973212407NF](#)
[597-3302-607F](#) [597-5202-407F](#) [598-8330-117F](#) [SAW8WA2A-L35M40-CA](#) [SML013WBDW1](#) [SML522BUWT86](#) [SML-LX0402IC-TR](#)
[CLMVC-FKA-CLBDGL7LBB79353](#)