

## Specifications

- Current rating:3A AC,DC
- Voltage rating:250V AC,DC
- Temperature range:-40°C~+105°C
- Contact resistance:30mΩMax.
- Insulation resistance:1000MΩMin.
- Withstanding voltage:1000V AC/minute
- \*Compliant with RoHS and REACH\*
- \*Meet the HF/Halogen Free,need to customize\*
- \*Contact CJT for details\*

## Standards



## Assembly layout

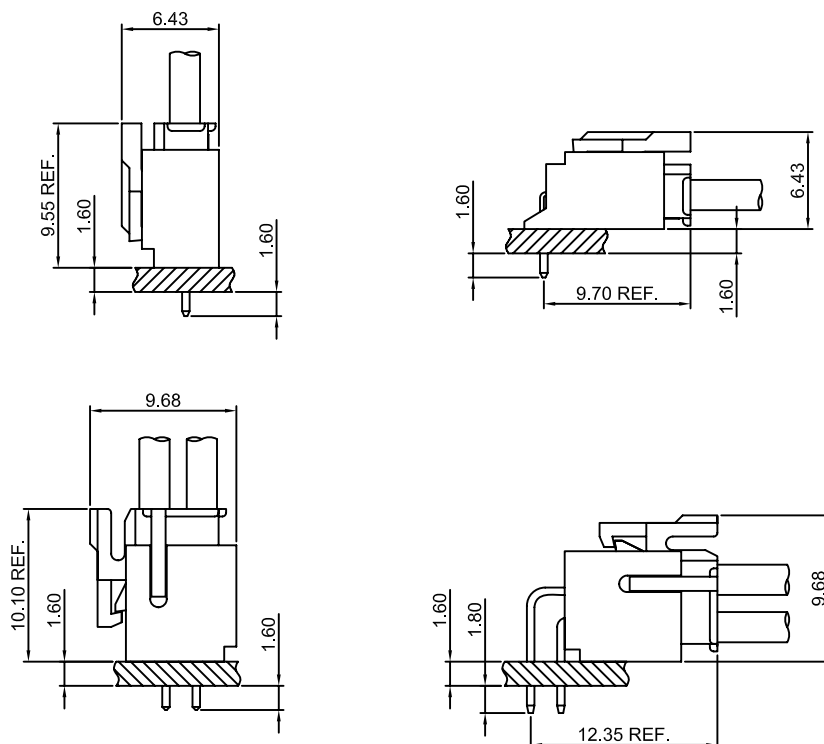

## A2008-T

2.00mm pitch Single Row Crimp Terminal

### Reference Informations:

\*Used in CJT A2008 series Single Row Housing

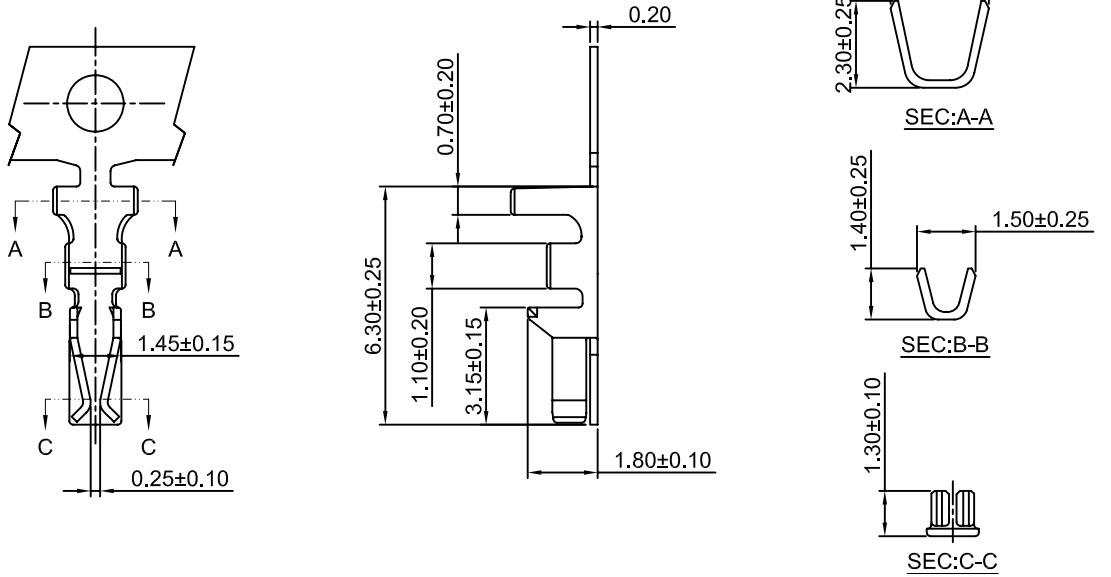

### Ordering information & Specifications:

Unit:mm

Part NO.	Wire Range	Insulation O.D.	Material	Finish	Qty/reel
A2008-TP	AWG#22-#30	1.45mm(max)	Phosphor Bronze	Tin over Nickel	10,000 PCS
A2008-GP	AWG#22-#30	1.45mm(max)	Phosphor Bronze	Gold over Nickel	10,000 PCS

Optional Gold plating available but MOQ requested

## A2008-T-A

2.00mm pitch Dual Row Crimp Terminal

### Reference Informations:

\*Used in CJT A2008 series Dual Row Housing

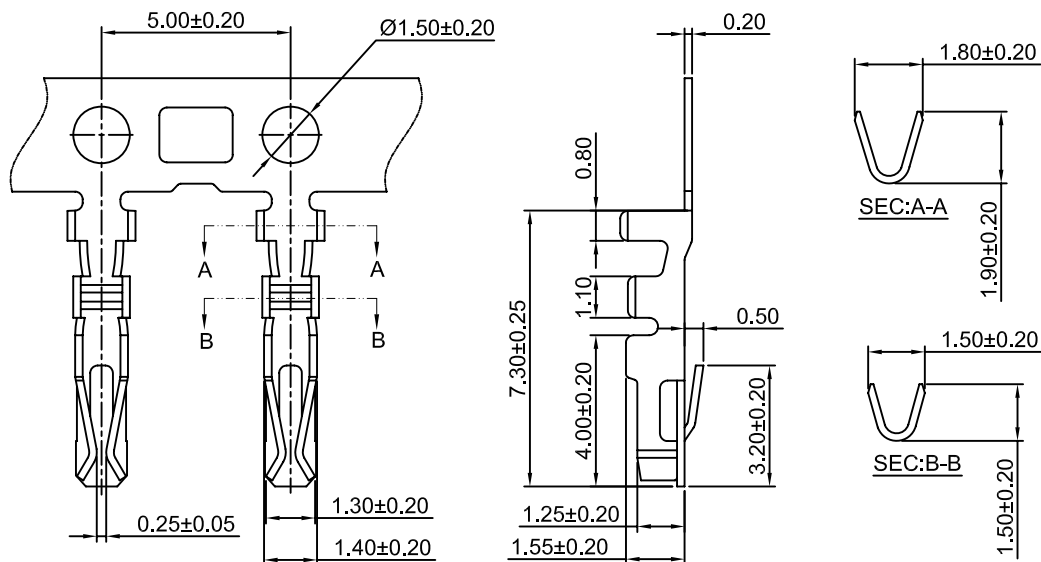

### Ordering information & Specifications:

Unit:mm

Part NO.	Wire Range	Insulation O.D.	Material	Finish	Qty/reel
A2008-TP-A	AWG#22-#30	1.45mm(max)	Phosphor Bronze	Tin over Nickel	10,000 PCS
A2008-GP-A	AWG#22-#30	1.45mm(max)	Phosphor Bronze	Gold over Nickel	10,000 PCS

Optional Gold plating available but MOQ requested

## A2008-T-B

2.00mm pitch Single Row Crimp Terminal

### Reference Informations:

\*Used in CJT A2008HA series Single Row Housing

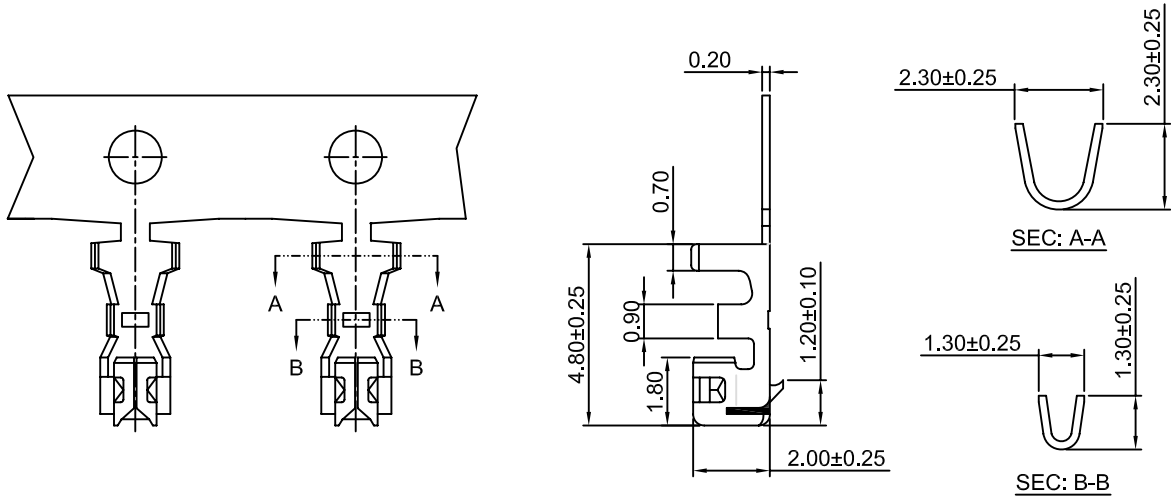

### Ordering information & Specifications:

Unit:mm

Part NO.	Wire Range	Insulation O.D.	Material	Finish	Qty/reel
A2008-TP-B	AWG#24-#30	1.40mm(max)	Phosphor Bronze	Tin over Nickel	10,000 PCS
A2008-GP-B	AWG#24-#30	1.40mm(max)	Phosphor Bronze	Gold over Nickel	10,000 PCS

Optional Gold plating available but MOQ requested

## A2008H-XP

2.00mm pitch Housing

### Reference Informations:

\*Material:Nylon 66,UL94V-0

\*Suitable CJT A2008 series Terminal

\*Mates with CJT A2008 series Single Row Wafer

\*Color:White

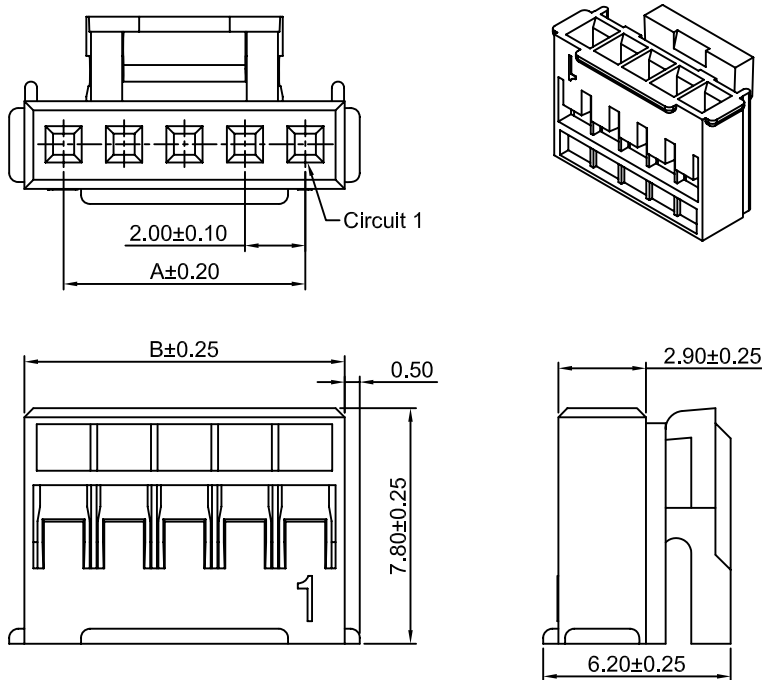

### Ordering Information & Dimensions:

PART NO.	Dimensions	
	A	B
3P	4.00	6.70
4P	6.00	8.70
5P	8.00	10.70
6P	10.00	12.70
7P	12.00	14.70
8P	14.00	16.70
9P	16.00	18.70
10P	18.00	20.70
11P	20.00	22.70
12P	22.00	24.70
13P	24.00	26.70
14P	26.00	28.70
15P	28.00	30.70
16P	30.00	32.70

Unit: mm

## A2008HA-XP

2.00mm pitch Housing

### Reference Informations:

- \*Material:Nylon 66,UL94V-0
- \*Suitable CJT A2008-T-B series Terminal
- \*Mates with CJT A2008WVA series Wafer
- \*Color:Ivory

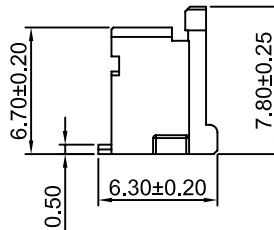
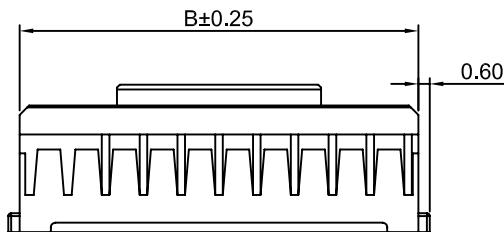
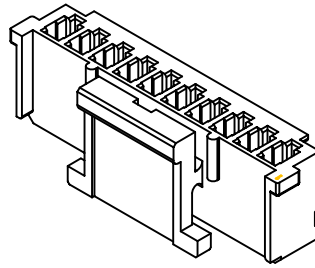
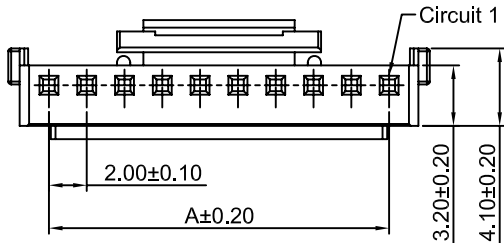

### Ordering Information & Dimensions:

PART NO.	Dimensions	
	A	B
4P	6.00	9.10
5P	8.00	11.10
6P	10.00	13.10
7P	12.00	15.10
8P	14.00	17.10
9P	16.00	19.10
10P	18.00	21.10
11P	20.00	23.10
12P	22.00	25.10
13P	24.00	27.10
14P	26.00	29.10
15P	28.00	31.10
16P	30.00	33.10
17P	32.00	35.10
18P	34.00	37.10
19P	36.00	39.10
20P	38.00	41.10

Unit: mm

## A2008HB-XP

2.00mm pitch Housing

### Reference Informations:

- \*Material:Nylon 66,UL94V-0
- \*Suitable CJT A2008-T-A series Terminal
- \*Mates with CJT A2008 series Single Row Wafer
- \*Color:White

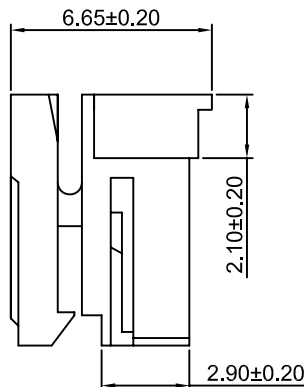
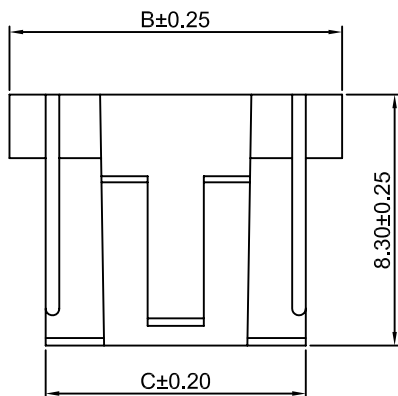
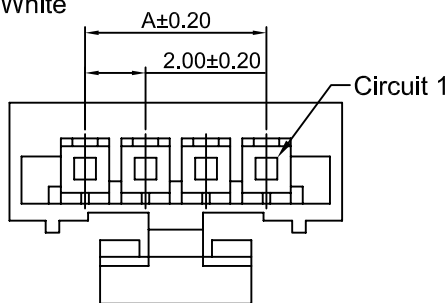

### Ordering Information & Dimensions:

PART NO.	Dimensions		
	A	B	C
2P	2.00	7.00	4.60
3P	4.00	9.00	6.60
4P	6.00	11.00	8.60
5P	8.00	13.00	10.60
6P	10.00	15.00	12.60
7P	12.00	17.00	14.60
8P	14.00	19.00	16.60
9P	16.00	21.00	18.60
10P	18.00	23.00	20.60
11P	20.00	25.00	22.60
12P	22.00	27.00	24.60
13P	24.00	29.00	26.60
14P	26.00	31.00	28.60
15P	28.00	33.00	30.60

Unit: mm

## A2008H-2xXP

2.00mm pitch Dual Row Housing

### Reference Informations:

- \*Material:Nylon 66,UL94V-0
- \*Suitable CJT A2008-T-A series Terminal
- \*Mates with CJT A2008 series Dual Row Wafer
- \*Color:White

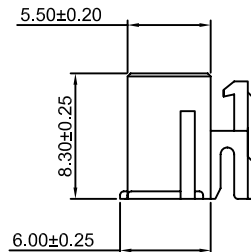
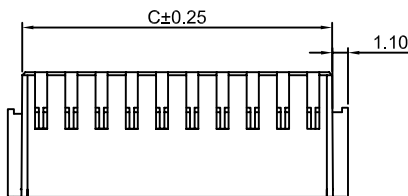
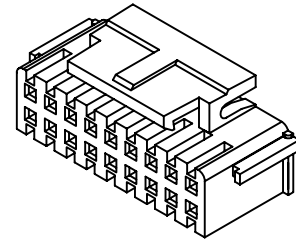
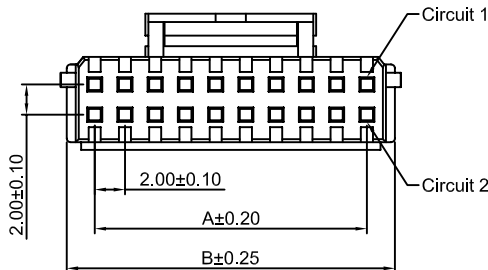

### Ordering Information & Dimensions:

PART NO.	Dimensions		
	A	B	C
2x3P	4.00	7.70	6.70
2x4P	6.00	9.70	8.70
2x5P	8.00	11.70	10.70
2x6P	10.00	13.70	12.70
2x7P	12.00	15.70	14.70
2x8P	14.00	17.70	16.70
2x9P	16.00	19.70	18.70
2x10P	18.00	21.70	20.70
2x11P	20.00	23.70	22.70
2x12P	22.00	25.70	24.70
2x13P	24.00	27.70	26.70
2x14P	26.00	29.70	28.70
2x15P	28.00	31.70	30.70
2x16P	30.00	33.70	32.70
2x20P	38.00	41.70	40.70

Unit: mm

## A2008WV-XP

2.00mm pitch 180° Wafer

### Reference Informations:

- \*Material:Pin:Brass/Tin over Nickel  
Insulator:Nylon 66,UL94V-0
- \*Mates with CJT A2008 series Single Row Housing
- \*Color:White

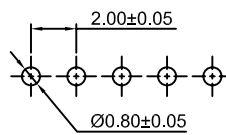
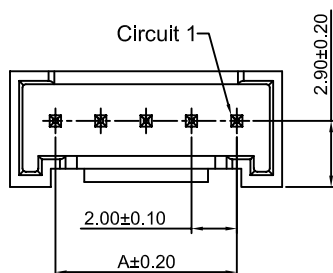

P.C.B LAYOUT

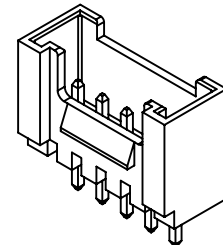
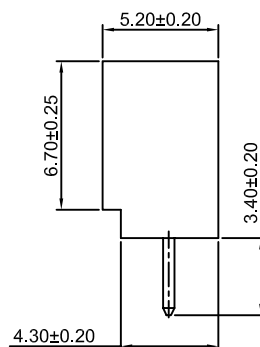
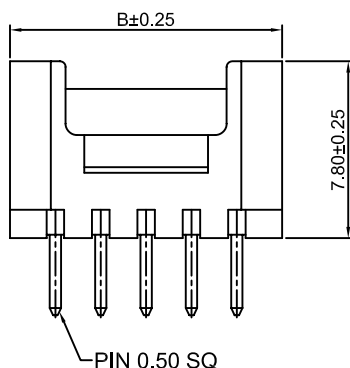

### Ordering Information & Dimensions:

PART NO.	Dimensions	
	A	B
2P	2.00	6.00
3P	4.00	8.00
4P	6.00	10.00
5P	8.00	12.00
6P	10.00	14.00
7P	12.00	16.00
8P	14.00	18.00
9P	16.00	20.00
10P	18.00	22.00
11P	20.00	24.00
12P	22.00	26.00
13P	24.00	28.00
14P	26.00	30.00
15P	28.00	32.00
16P	30.00	34.00

Unit: mm

## A2008WR-XP

2.00mm pitch 90° Wafer

### Reference Informations:

- \*Material:Pin:Brass/Tin over Nickel  
Insulator:Nylon 66,UL94V-0
- \*Mates with CJT A2008 series Single Row Housing
- \*Color:White

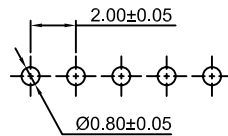
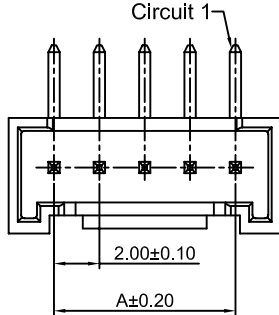

P.C.B LAYOUT

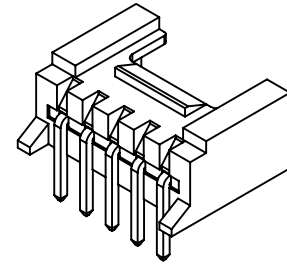
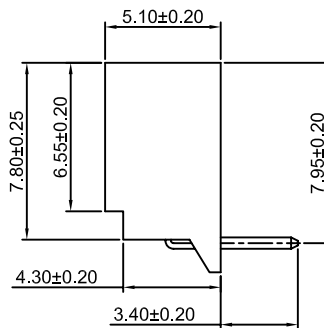
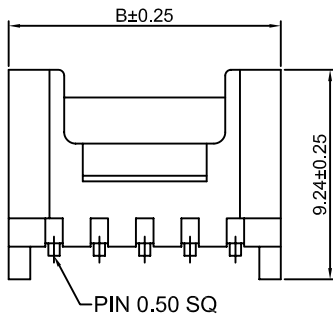

### Ordering Information & Dimensions:

PART NO.	Dimensions	
	A	B
2P	2.00	6.00
3P	4.00	8.00
4P	6.00	10.00
5P	8.00	12.00
6P	10.00	14.00
7P	12.00	16.00
8P	14.00	18.00
9P	16.00	20.00
10P	18.00	22.00
11P	20.00	24.00
12P	22.00	26.00
13P	24.00	28.00
14P	26.00	30.00
15P	28.00	32.00
16P	30.00	34.00

Unit: mm

## A2008WVA-XP

2.00mm pitch 180° Wafer

### Reference Informations:

- \*Material:Pin:Brass/Tin over Nickel  
Insulator:Nylon 66,UL94V-0
- \*Mates with CJT A2008HA series Single Row Housing
- \*Color:Ivory

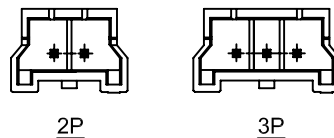
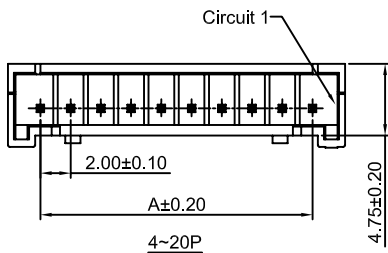

P.C.B LAYOUT

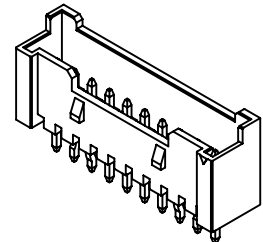
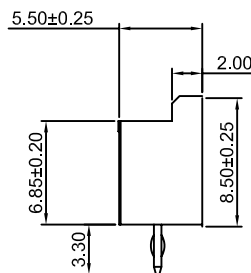
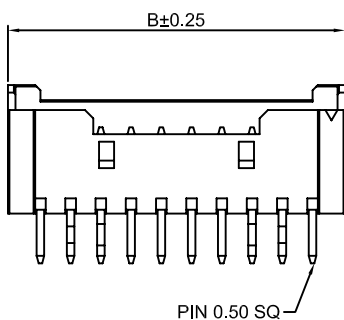

### Ordering Information & Dimensions:

PART NO.	Dimensions	
	A	B
2P	2.00	7.70
3P	4.00	9.70
4P	6.00	10.30
5P	8.00	12.30
6P	10.00	14.30
7P	12.00	16.30
8P	14.00	18.30
9P	16.00	20.30
10P	18.00	22.30
11P	20.00	24.30
12P	22.00	26.30
13P	24.00	28.30
14P	26.00	30.30
15P	28.00	32.30
16P	30.00	34.30
17P	32.00	36.30
18P	34.00	38.30
19P	36.00	40.30
20P	38.00	42.30

Unit: mm

## A2008WRA-XP

2.00mm pitch 90° Wafer

### Reference Informations:

- \*Material:Pin:Brass/Tin over Nickel  
Insulator:Nylon 66,UL94V-0
- \*Mates with CJT A2008HA series Single Row Housing
- \*Color:Ivory

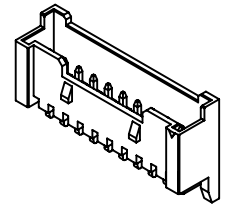
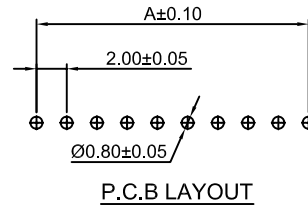
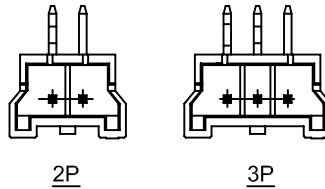
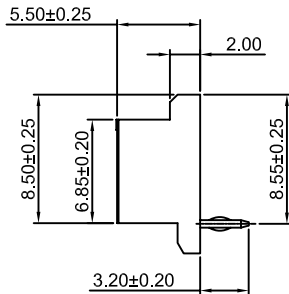
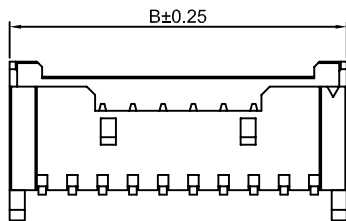
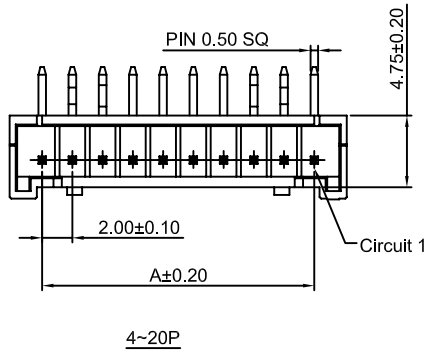

### Ordering Information & Dimensions:

PART NO.	Dimensions	
	A	B
2P	2.00	7.70
3P	4.00	9.70
4P	6.00	10.30
5P	8.00	12.30
6P	10.00	14.30
7P	12.00	16.30
8P	14.00	18.30
9P	16.00	20.30
10P	18.00	22.30
11P	20.00	24.30
12P	22.00	26.30
13P	24.00	28.30
14P	26.00	30.30
15P	28.00	32.30
16P	30.00	34.30
17P	32.00	36.30
18P	34.00	38.30
19P	36.00	40.30
20P	38.00	42.30

Unit: mm

## A2008WV-2xXP

2.00mm pitch 180° Dual Row Wafer

### Reference Informations:

- \*Material:Pin:Brass/Tin over Nickel  
Insulator:Nylon 66,UL94V-0
- \*Mates with CJT A2008 series Dual Row Housing
- \*Color:Ivory

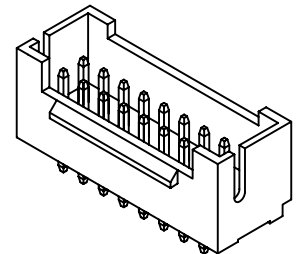
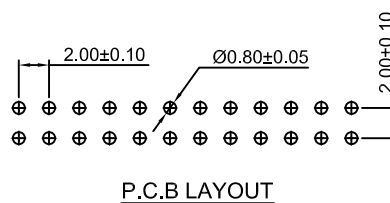
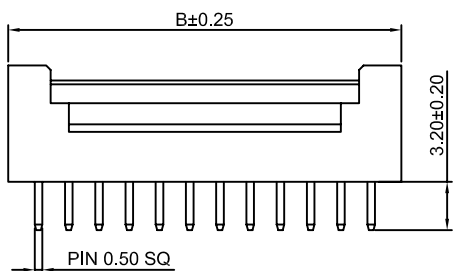
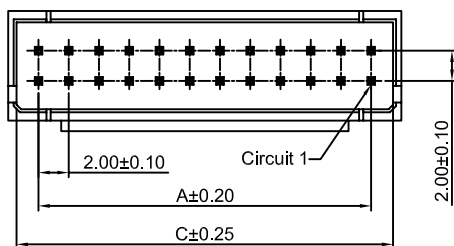

### Ordering Information & Dimensions:

PART NO.	Dimensions		
	A	B	C
2x3P	4.00	8.00	6.80
2x4P	6.00	10.00	8.80
2x5P	8.00	12.00	10.80
2x6P	10.00	14.00	12.80
2x7P	12.00	16.00	14.80
2x8P	14.00	18.00	16.80
2x9P	16.00	20.00	18.80
2x10P	18.00	22.00	20.80
2x11P	20.00	24.00	22.80
2x12P	22.00	26.00	24.80
2x13P	24.00	28.00	26.80
2x14P	26.00	30.00	28.80
2x15P	28.00	32.00	30.80
2x16P	30.00	34.00	32.80
2x20P	38.00	42.00	40.80

Unit: mm

## A2008WR-2xXP

2.00mm pitch 90° Dual Row Wafer

### Reference Informations:

- \*Material: Pin: Brass/Tin over Nickel  
Insulator: Nylon 66, UL94V-0
- \*Mates with CJT A2008 series Dual Row Housing
- \*Color: Ivory

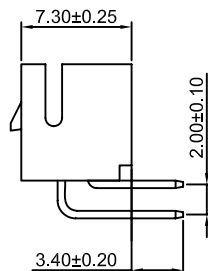
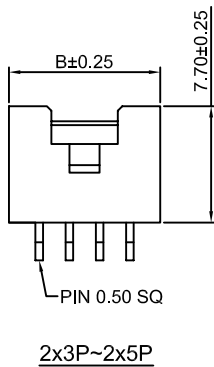
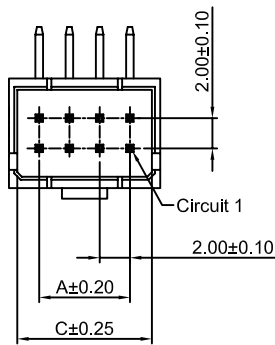
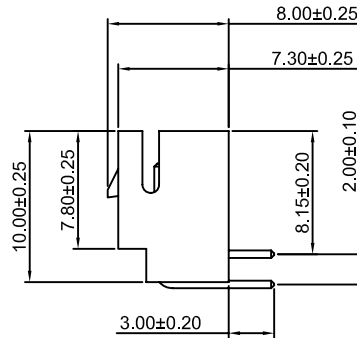
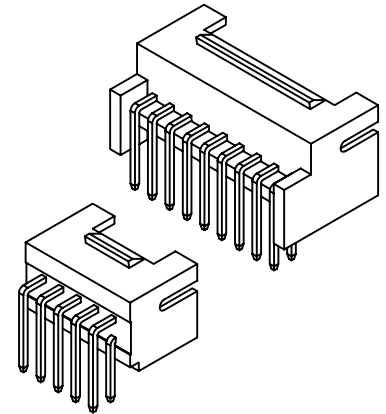
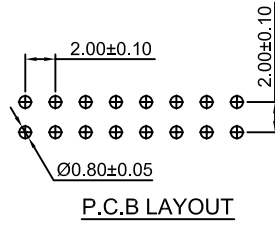
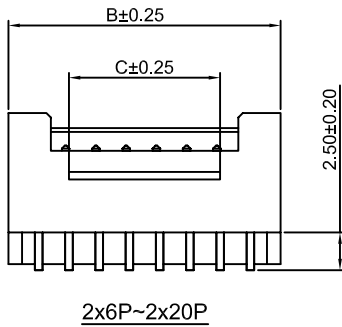
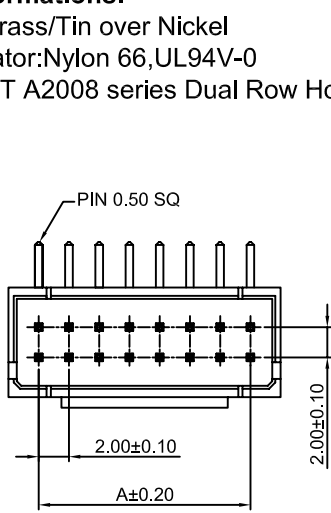

### Ordering Information & Dimensions:

PART NO.	Dimensions		
	A	B	C
2x3P	4.00	8.00	6.80
2x4P	6.00	10.00	8.80
2x5P	8.00	12.00	10.80
2x6P	10.00	14.00	12.80
2x7P	12.00	16.00	14.80
2x8P	14.00	18.00	16.80
2x9P	16.00	20.00	18.80
2x10P	18.00	22.00	20.80
2x11P	20.00	24.00	22.80
2x12P	22.00	26.00	24.80
2x13P	24.00	28.00	26.80
2x14P	26.00	30.00	28.80
2x15P	28.00	32.00	30.80
2x16P	30.00	34.00	32.80
2x20P	38.00	42.00	40.80

Unit: mm



## A2008WV-S-XP

2.00mm pitch 180° Wafer-SMT TYPE

### Reference Informations:

- \*Material: Pin: Brass/Tin over Nickel  
Insulator: Nylon6T, UL94V-0
- \*Mates with CJT A2008 series Single Row Housing
- \*Color: Ivory

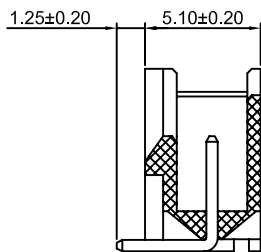
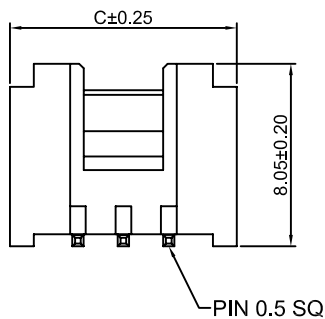
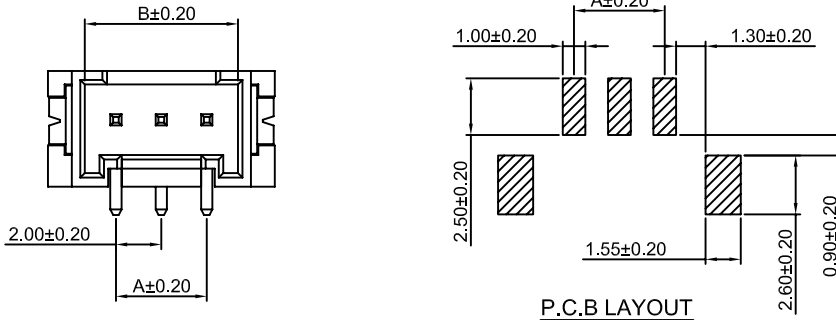
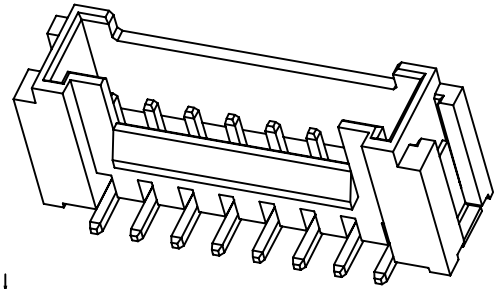

### Ordering Information & Dimensions:

PART NO.	Dimensions		
	A	B	C
2P	2.00	4.75	8.00
3P	4.00	6.75	10.00
4P	6.00	8.75	12.00
5P	8.00	10.75	14.00
6P	10.00	12.75	16.00
7P	12.00	14.75	18.00
8P	14.00	16.75	20.00
9P	16.00	18.75	22.00
10P	18.00	20.75	24.00
11P	20.00	22.75	26.00
12P	22.00	24.75	28.00
13P	24.00	26.75	30.00
14P	26.00	28.75	32.00
15P	28.00	30.75	34.00
16P	30.00	32.75	36.00

Unit: mm

## A2008WR-S-XP

2.00mm pitch 90° Wafer-SMT TYPE

### Reference Informations:

- \*Material: Pin: Brass/Tin over Nickel  
Insulator: Nylon6T, UL94V-0
- \*Mates with CJT A2008 series Single Row Housing
- \*Color: Beige

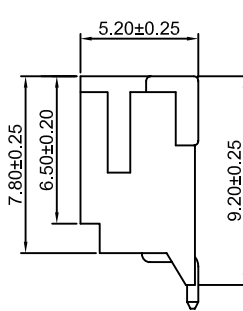
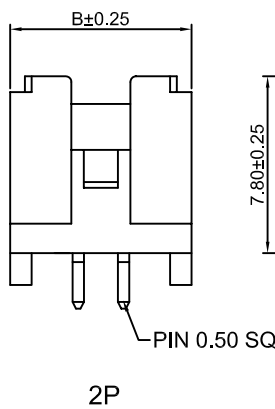
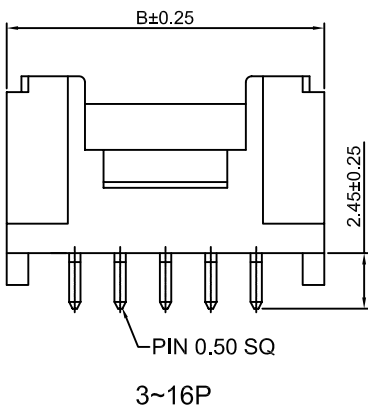
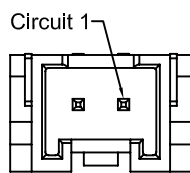
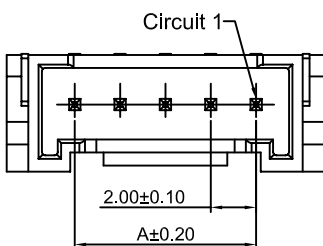
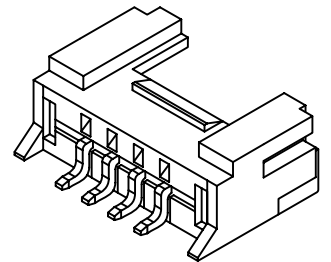
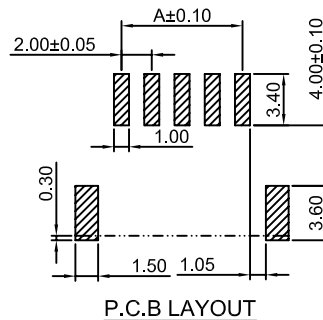

### Ordering Information & Dimensions:

PART NO.	Dimensions	
	A	B
2P	2.00	8.00
3P	4.00	10.00
4P	6.00	12.00
5P	8.00	14.00
6P	10.00	16.00
7P	12.00	18.00
8P	14.00	20.00
9P	16.00	22.00
10P	18.00	24.00
11P	20.00	26.00
12P	22.00	28.00
13P	24.00	30.00
14P	26.00	32.00
15P	28.00	34.00
16P	30.00	36.00

Unit: mm

## A2008WV-S-2xXP

2.00mm pitch 180° Dual Row Wafer-SMT TYPE

### Reference Informations:

- \*Material: Pin: Brass/Tin over Nickel  
Insulator: Nylon6T, UL94V-0
- \*Mates with CJT A2008 series Dual Row Housing
- \*Color: Ivory

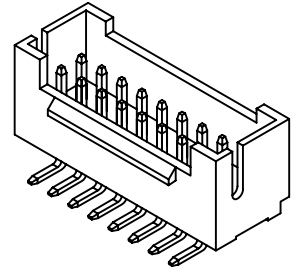
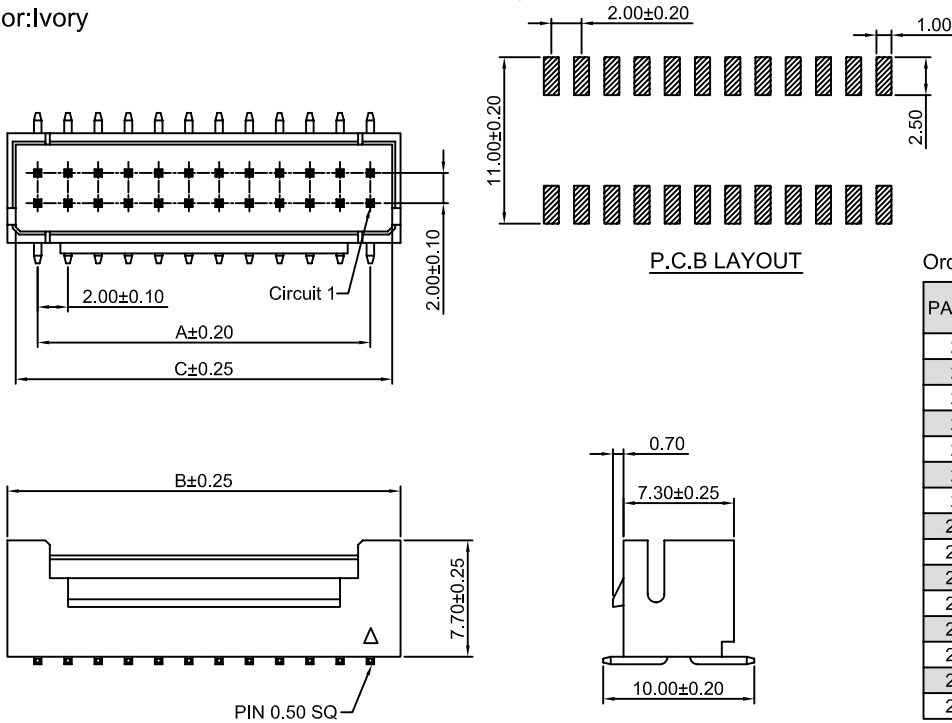

### Ordering Information & Dimensions:

PART NO.	Dimensions		
	A	B	C
2x3P	4.00	8.00	6.80
2x4P	6.00	10.00	8.80
2x5P	8.00	12.00	10.80
2x6P	10.00	14.00	12.80
2x7P	12.00	16.00	14.80
2x8P	14.00	18.00	16.80
2x9P	16.00	20.00	18.80
2x10P	18.00	22.00	20.80
2x11P	20.00	24.00	22.80
2x12P	22.00	26.00	24.80
2x13P	24.00	28.00	26.80
2x14P	26.00	30.00	28.80
2x15P	28.00	32.00	30.80
2x16P	30.00	34.00	32.80
2x20P	38.00	42.00	40.80

Unit: mm

## A2008S-XP

2.00mm pitch Seal

### Reference Informations:

- \*Material: Nylon 66, UL94V-2
- \*Use in CJT A2008 series Housing
- \*Color: Brick red

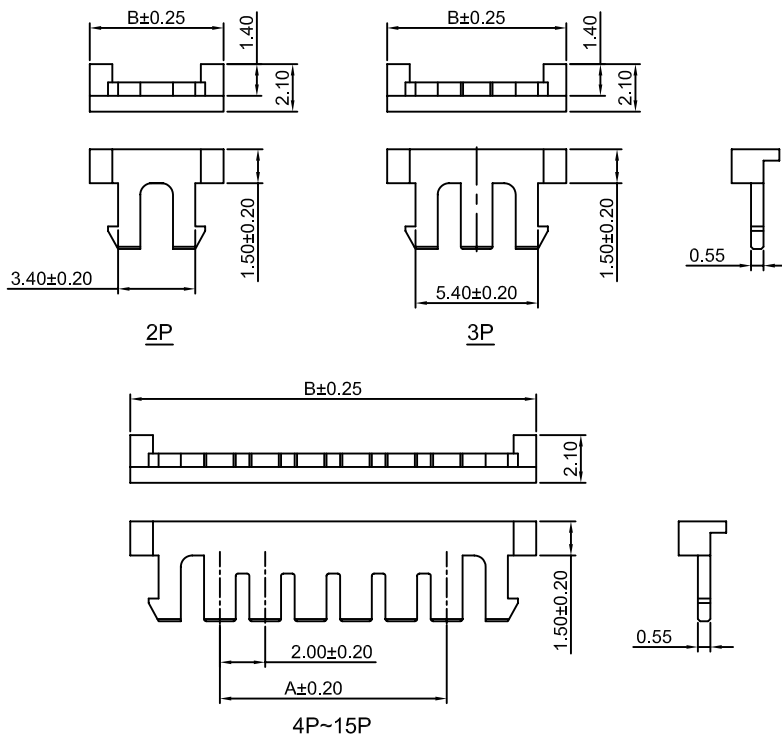

### Ordering Information & Dimensions:

PART NO.	Dimensions	
	A	B
2P	3.40	5.90
3P	5.40	7.90
4P	7.40	9.90
5P	9.40	11.90
6P	11.40	13.90
7P	13.40	15.90
8P	15.40	17.90
9P	17.40	19.90
10P	19.40	21.90
11P	21.40	23.90
12P	23.40	25.90
13P	25.40	27.90
14P	27.40	29.90
15P	29.40	31.90

Unit: mm

## X-ON Electronics

Largest Supplier of Electrical and Electronic Components

*Click to view similar products for [Headers & Wire Housings](#) category:*

*Click to view products by [Changjiang](#) manufacturer:*

Other Similar products are found below :

[95000-104TRLF](#) [10135584-644402LF](#) [DF62W-EP2022PCA](#) [95000-106TRLF](#) [DF62W-2022SCA](#) [DF62W-EP2022PC](#) [2203348](#) [DF62W-2022SC](#) [1084018](#) [1029039](#) [1084017](#) [802-10-012-10-002000](#) [1112640](#) [1112639](#) [891-007-9SS-BST1T](#) [000-34000](#) [0008550134](#) [0009482033](#) [0009507031](#) [57102-F02-18ULF](#) [57102-S06-03LF](#) [57202-S52-04LF](#) [PCN6-15S-2.5E](#) [0039019024](#) [58102-G61-06LF](#) [582553-1](#) [0009485154](#) [0009508121](#) [0022285053](#) [0050291907](#) [018731A](#) [LY20-4P-DT1-P1E-BR](#) [02.125.8002.8](#) [60101931](#) [60598-1 \(Cut Strip\)](#) [M1625-3R/100](#) [61062-3](#) [61082-181009](#) [CSU011177004](#) [636-1427](#) [638009-1](#) [641938-9](#) [641991-4](#) [644168-1](#) [644827-2](#) [647662-1](#) [65039-019ELF](#) [65692-001LF](#) [65781-018](#) [65781-047](#)