

## Specifications

Current rating:3A AC,DC  
Voltage rating:250V AC,DC  
Temperature range:-40°C~+105°C  
Contact resistance:20mΩMax.  
Insulation resistance:1000MΩMin.  
Withstanding voltage:1500V AC/minute  
\*Compliant with RoHS and REACH\*  
\*Meet the HF/Halogen Free,need to customize\*  
\*Contact CJT for details\*

## Standards



## Assembly layout

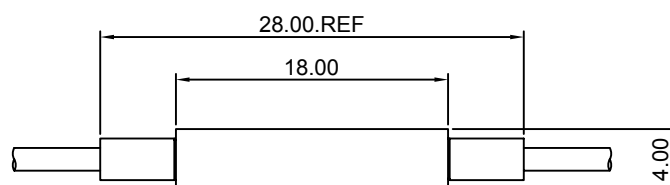
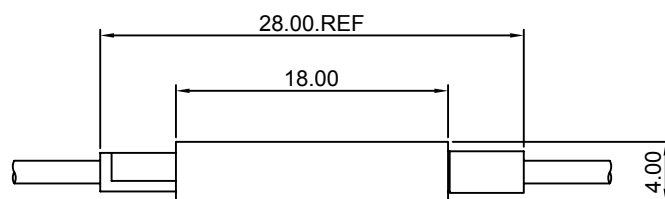

## A2510HF-3P-P

2.54mm pitch Housing

### Reference Informations:

- \*Material:Nylon 66 ,UL94V-0
- \*Suitable CJT A2541-T series Terminal
- \*Mates with CJT A2510HM-P-R series Housing
- \*Color:Black

### Ordering Information:

A2510HF-3P-P - \*\*\*  
1 2

1.Part No.

2.Material:

(Blank):Nylon 66,UL94V-0

GWT :Nylon 66,UL94V-0,GWT 750 °C

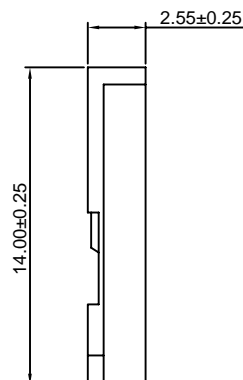
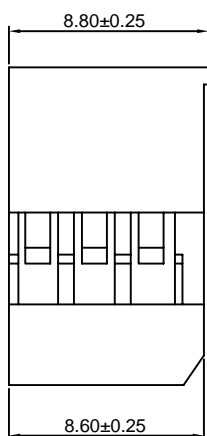
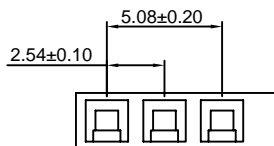
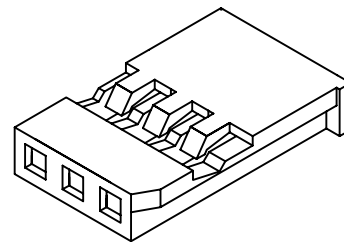

Unit: mm

## A2510HF-3P-R

2.54mm pitch Housing

### Reference Informations:

- \*Material:Nylon 66 ,UL94V-0
- \*Suitable CJT A2541-T series Terminal
- \*Mates with CJT A2510HM-R-R series Housing
- \*Color:Black

### Ordering Information:

A2510HF-3P-R - \*\*\*  
1 2

1.Part No.

2.Material:

(Blank):Nylon 66,UL94V-0

GWT :Nylon 66,UL94V-0,GWT 750 °C

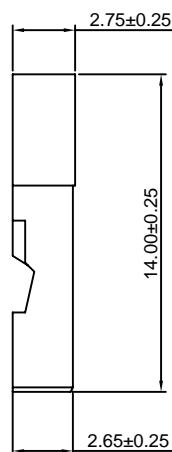
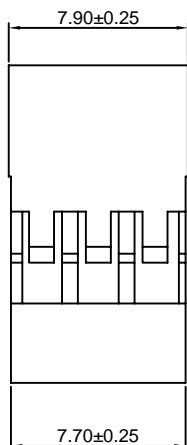
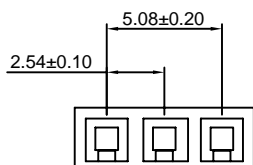
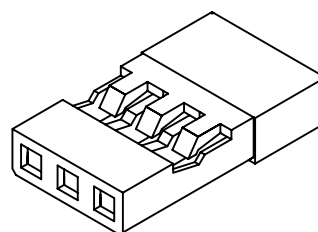

Unit: mm

**A2510HM-P-R**

2.54mm pitch Housing

**Reference Informations:**

- \*Material:Nylon 66 ,UL94V-0
- \*Mates with CJT A2510HF-3P-P series Housing
- \*Color:Black

**Ordering Information:**

- A2510HM-P-R - \*\*\*
- 1 2
- 1.Part No.
- 2.Material:
- (Blank):Nylon 66,UL94V-0
- GWT :Nylon 66,UL94V-0,GWT 750 °C

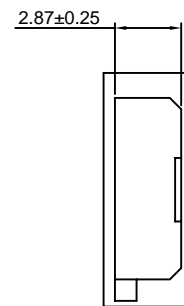
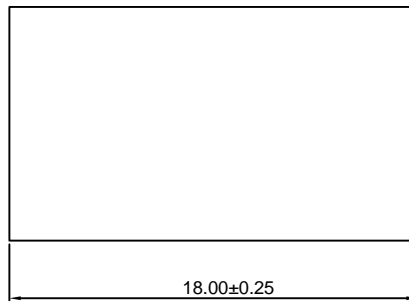
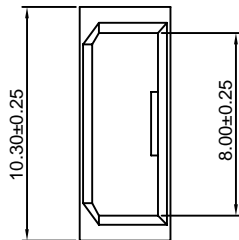
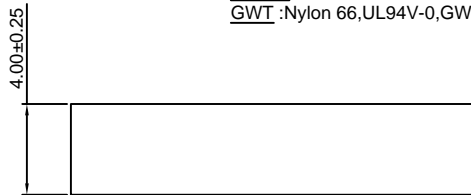
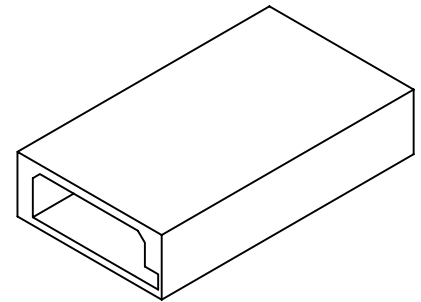

Unit: mm

**A2510HM-R-R**

2.54mm pitch Housing

**Reference Informations:**

- \*Material:Nylon 66 ,UL94V-0
- \*Mates with CJT A2510HF-3P-R series Housing
- \*Color:Black

**Ordering Information:**

- A2510HM-R-R - \*\*\*
- 1 2
- 1.Part No.
- 2.Material:
- (Blank):Nylon 66,UL94V-0
- GWT :Nylon 66,UL94V-0,GWT 750 °C

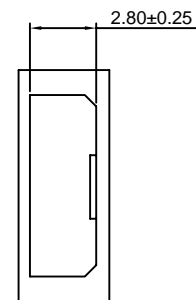
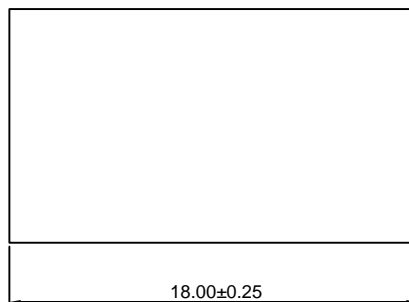
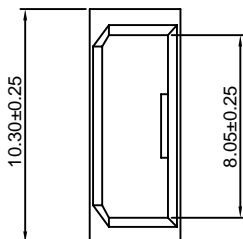
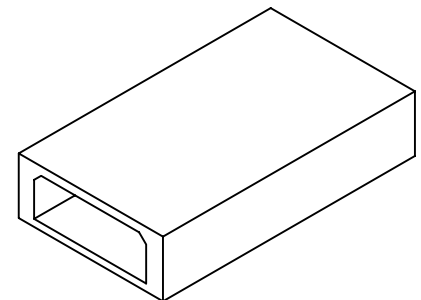

Unit: mm

### A2510HMA-3P

2.54mm pitch Housing

**Reference Informations:**

- \*Material:PBT ,UL94V-0
- \*Suitable CJT A2541M-T Terminal
- \*Mates with CJT A2510HF-3P-P series Housing
- \*Color:Black

**Ordering Information:**

- A2510HMA-3P - \*\*\* - \*\*\*  
 1                    2                    3
- 1.Part No.
  - 2.Material:  
 (blank):PBT,UL94V-0  
 GWT :PBT,UL94V-0,GWT 750℃
  - 3.Color:  
 (blank):Black  
 BRD:Brick red

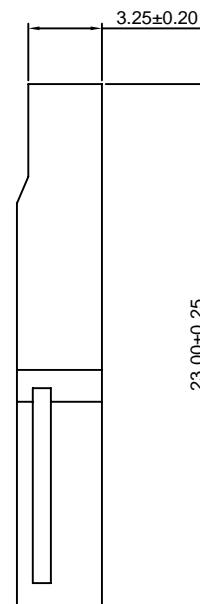
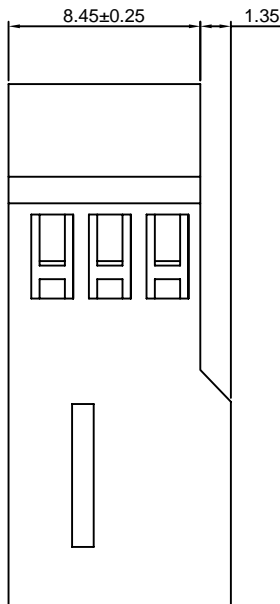
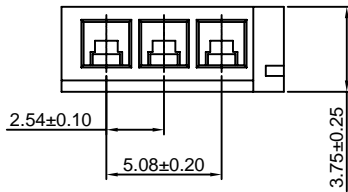
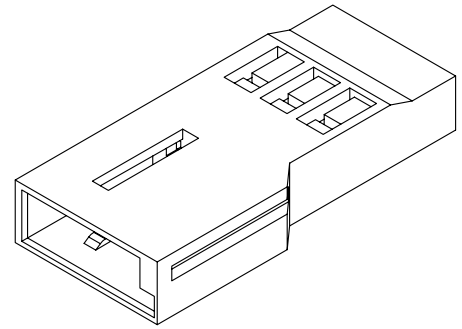

## X-ON Electronics

Largest Supplier of Electrical and Electronic Components

*Click to view similar products for [Headers & Wire Housings](#) category:*

*Click to view products by [Changjiang](#) manufacturer:*

Other Similar products are found below :

[95000-104TRLF](#) [10135584-644402LF](#) [DF62W-EP2022PCA](#) [95000-106TRLF](#) [DF62W-2022SCA](#) [DF62W-EP2022PC](#) [2203348](#) [DF62W-2022SC](#) [1084018](#) [1029039](#) [1084017](#) [802-10-012-10-002000](#) [1112640](#) [1112639](#) [891-007-9SS-BST1T](#) [000-34000](#) [0008550134](#) [0009482033](#) [0009507031](#) [57102-F02-18ULF](#) [57102-S06-03LF](#) [57202-S52-04LF](#) [PCN6-15S-2.5E](#) [0039019024](#) [58102-G61-06LF](#) [582553-1](#) [0009485154](#) [0009508121](#) [0022285053](#) [0050291907](#) [018731A](#) [LY20-4P-DT1-P1E-BR](#) [02.125.8002.8](#) [60101931](#) [60598-1 \(Cut Strip\)](#) [M1625-3R/100](#) [61062-3](#) [61082-181009](#) [CSU011177004](#) [636-1427](#) [638009-1](#) [641938-9](#) [641991-4](#) [644168-1](#) [644827-2](#) [647662-1](#) [65039-019ELF](#) [65692-001LF](#) [65781-018](#) [65781-047](#)