

Circuit	Dimensions				
	No.	A	B	C	D
02P	1.25	4.15	6.25	3.15	---
03P	2.50	5.40	7.50	4.40	1.25
04P	3.75	6.65	8.75	5.65	2.50
05P	5.00	7.90	10.00	6.90	3.75
06P	6.25	9.15	11.25	8.15	5.00
07P	7.50	10.40	12.50	9.40	6.25
08P	8.75	11.65	13.75	10.65	7.50
09P	10.00	12.90	15.00	11.90	8.75
10P	11.25	14.15	16.25	13.15	10.00
11P	12.50	15.40	17.50	14.40	11.25
12P	13.75	16.65	18.75	15.65	12.50
13P	15.00	17.90	20.00	16.90	13.75
14P	16.25	19.15	21.25	18.15	15.00
15P	17.50	20.40	22.50	19.40	16.25

REV.	DESCRIPTION	DATE	NAME	X.XXX±0.05	ANGLE
A5	EN1601210001	2016.01.25	劉建秀	X.XX±0.15	
A4	EN1202060018	2012.02.06	陳錦展	X.XX±0.25	
A3	EN1106240218	2011.06.24	陳敏		
A2	EN1012010279	2010.12.01	陳錦展		
DRAWN BY: 歐陽小強 校正: 2007.01.05					
APPROVED BY: 2007.01.05					
GENERAL TOLERANCE					
TITLE: 1.25mm PITCH 180° SINGLE ROW WAFER- SMT TYPE, W/O BOSS					
DRAW NO.: A1252WV-S-XP					
REV. A5					

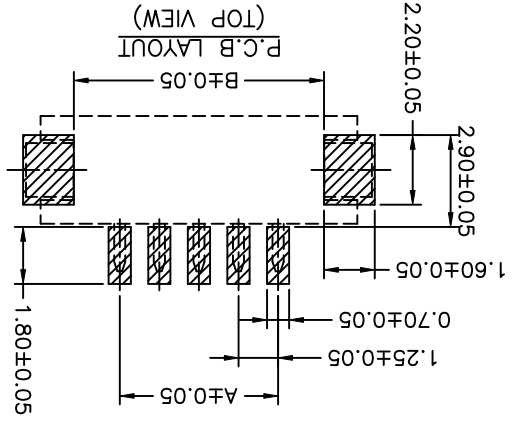

燦達電子工業股份有限公司
 JOINT TECH ELECTRONIC IND. CO., LTD.

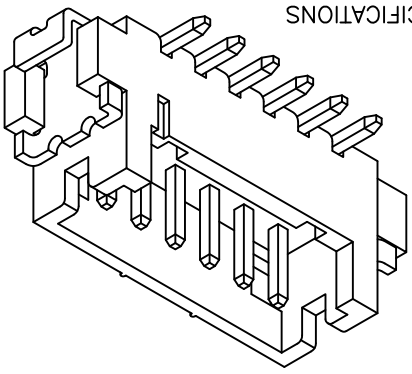

P/N LEGEND
 A1252 WV-S-XP XXX
 ① Series No.
 ② Connector type: W=Vertical
 ③ Mounting type: S=SMT
 ④ No. of circuits
 ⑤ Option code:
 D01=Contacts/Gold-flash and
 Solder tabs/Gold-flash
 Color: Natural(Beige)

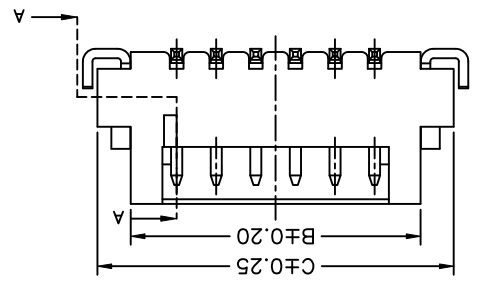
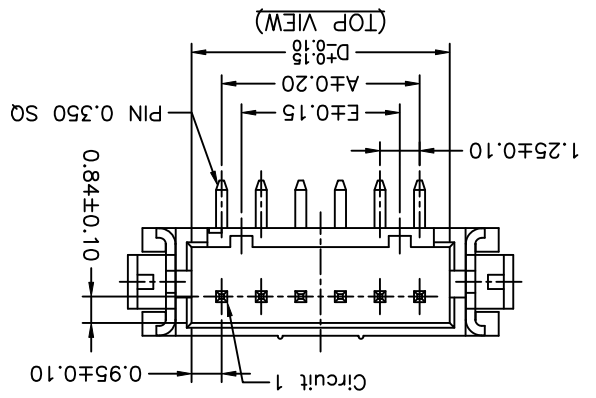
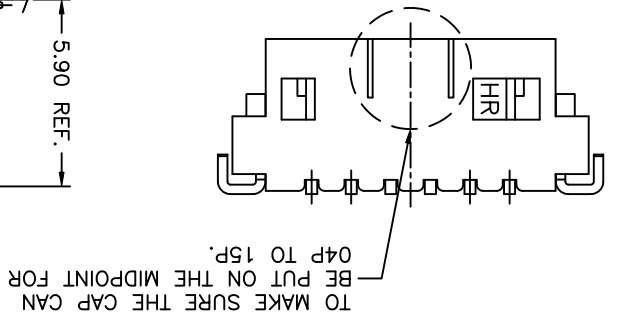
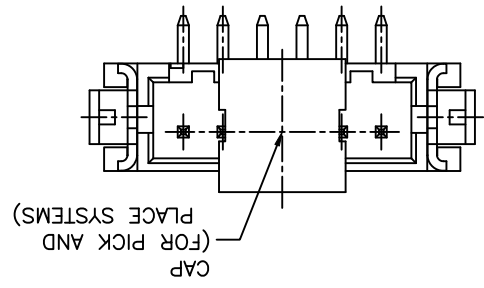
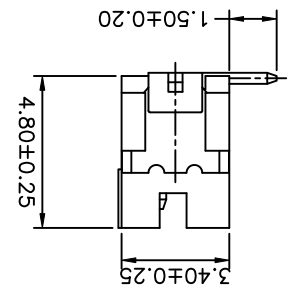
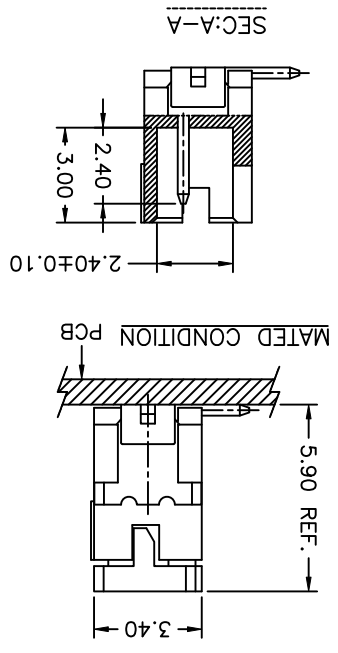

SPECIFICATIONS
 Current Rating: 1A AC,DC
 Voltage Rating: 150V AC,DC
 Temperature Range: -25°C ~ +85°C
 Contact Resistance: 30mΩ Max.
 Insulation Resistance: 500MΩ Min.
 Withstanding Voltage: 500V AC/minute
 Pin Material: Brass
 Solder Tabs: Phosphor Bronze
 Water: Nylon 6T,UL94V-0
 Cap: Nylon 6T,UL94V-0



X-ON Electronics

Largest Supplier of Electrical and Electronic Components

Click to view similar products for [Headers & Wire Housings](#) category:

Click to view products by [Joint manufacturer](#):

Other Similar products are found below :

[95000-104TRLF](#) [10135584-644402LF](#) [DF62W-EP2022PCA](#) [95000-106TRLF](#) [DF62W-2022SCA](#) [DF62W-EP2022PC](#) [2203348](#) [DF62W-2022SC](#) [1084018](#) [1029039](#) [1084017](#) [802-10-012-10-002000](#) [1112640](#) [1112639](#) [891-007-9SS-BST1T](#) [000-34000](#) [0008550134](#) [0009482033](#) [0009507031](#) [57102-F02-18ULF](#) [57102-S06-03LF](#) [57202-S52-04LF](#) [PCN6-15S-2.5E](#) [0039019024](#) [58102-G61-06LF](#) [582553-1](#) [0009485154](#) [0009508121](#) [0022285053](#) [0050291907](#) [018731A](#) [LY20-4P-DT1-P1E-BR](#) [02.125.8002.8](#) [60101931](#) [60598-1 \(Cut Strip\)](#) [M1625-3R/100](#) [61062-3](#) [61082-181009](#) [CSU011177004](#) [636-1427](#) [638009-1](#) [641938-9](#) [641991-4](#) [644168-1](#) [644827-2](#) [647662-1](#) [65039-019ELF](#) [65692-001LF](#) [65781-018](#) [65781-047](#)