



# CDM/CDH SERIES

DIP

TACT

LED TACT

PUSH BUTTON

TOGGLE

SLIDE

ROCKER

MICRO / POWER

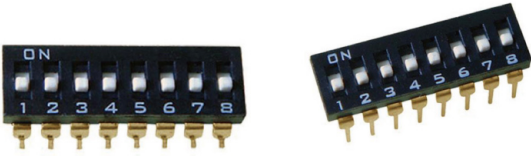

## HOW TO ORDER

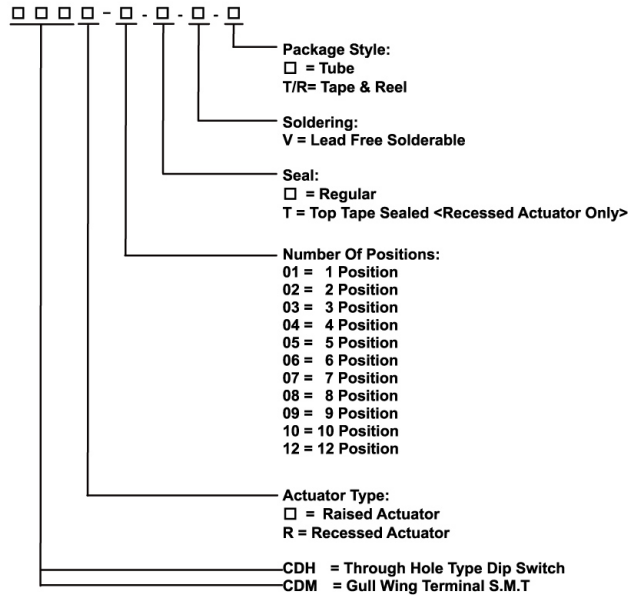

## SPECIFICATIONS

Mechanical life:2000 operations per switch  
 Operation Force:1000gf max.  
 Stroke :1.0mm  
 Operation Temp:-20℃ to 70℃  
 Electrical life:2000 operations per switch-24 VDC, 25mA  
 Contact Resistance:100m max. at initial  
 Non-Switching Rating:100mA, 50VDC  
 Switching Rating:25mA, 24VDC  
 Circuit:Single pole single throw

## CDM SERIES SLIDE TYPE

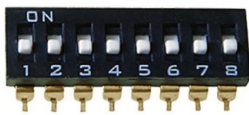

## CONTACT SYSTEM

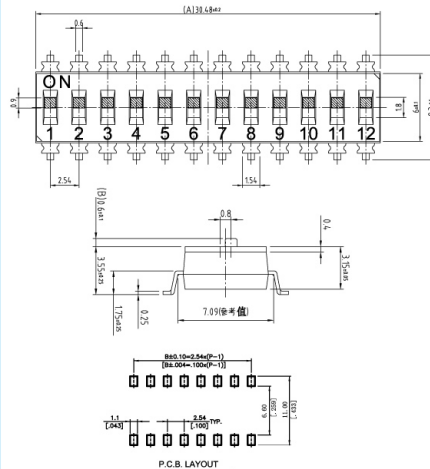
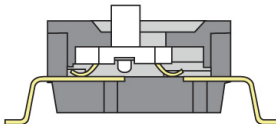

MODEL NO.	NO. POS	A
CDM-02	2	2.54
CDM-03	3	5.08
CDM-04	4	7.62
CDM-05	5	10.16
CDM-06	6	12.70
CDM-07	7	15.24
CDM-08	8	17.78
CDM-09	9	20.32
CDM-10	10	22.86
CDM-12	12	25.40

Schematic(TYP.)



## CDH SERIES SLIDE TYPE

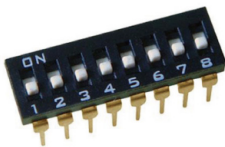

## CONTACT SYSTEM

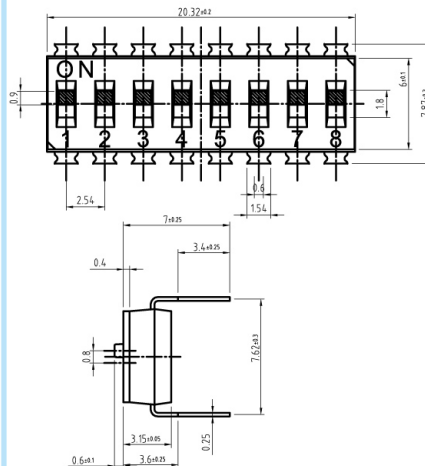
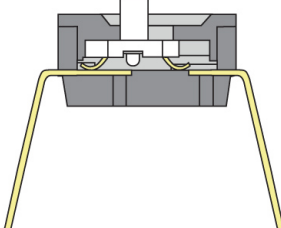

MODEL NO.	NO. POS	A
CDH-02	2	2.54
CDH-03	3	5.08
CDH-04	4	7.62
CDH-05	5	10.16
CDH-06	6	12.70
CDH-07	7	15.24
CDH-08	8	17.78
CDH-09	9	20.32
CDH-10	10	22.86
CDH-12	12	25.40

Schematic(TYP.)



## X-ON Electronics

Largest Supplier of Electrical and Electronic Components

*Click to view similar products for [DIP Switches/SIP Switches](#) category:*

*Click to view products by [Challenge manufacturer](#):*

Other Similar products are found below :

[78M03S](#) [79B10T](#) [8136-475G4T](#) [G7G-1A2-CB-DC12](#) [A7SS-M](#) [DBP 2110](#) [DBP 2112](#) [DBS1008](#) [DHN02FTVTR](#) [DHN10T](#) [DHS108](#)  
[DPL08TN](#) [DRD16CSE04](#) [DRR4010](#) [DRR60016](#) [DRS4016](#) [BD06E](#) [1825008-1](#) [1825444-1](#) [25.350.0653.0](#) [LA2-DC12](#) [SBS 5004 TG](#)  
[SDA10H1BDA](#) [97R06ST](#) [A2C-2A5](#) [1825444-7](#) [ADE08SA04](#) [ADE12S04](#) [2161391-1](#) [2-1825058-8](#) [CCVA 2.5/ 4-G-5.08](#) [P26THRR32](#)  
[25.330.0653.1](#) [25.352.0353.0](#) [MDG305ST](#) [IKN0600000](#) [IKN0800000](#) [LA2-002-DC24](#) [DBP2008](#) [DBS1003](#) [DBS2008](#) [438872000](#)  
[DRD10CRAE04](#) [DRS1604](#) [DSR02T](#) [DSS 208 N](#) [5-1825033-1](#) [106-SDN06-EV](#) [1-1437507-6](#) [E2FMX2D1M1TGJ03M](#)  
[E3ZMCT81M1TJ03M](#)