

PRELIMINARY

背景
BACK GROUND
SCDG1A0109
Correction
Design change:
Taping spec.

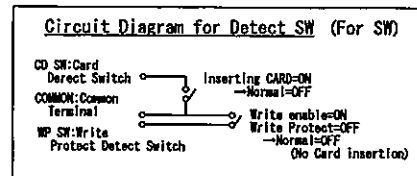
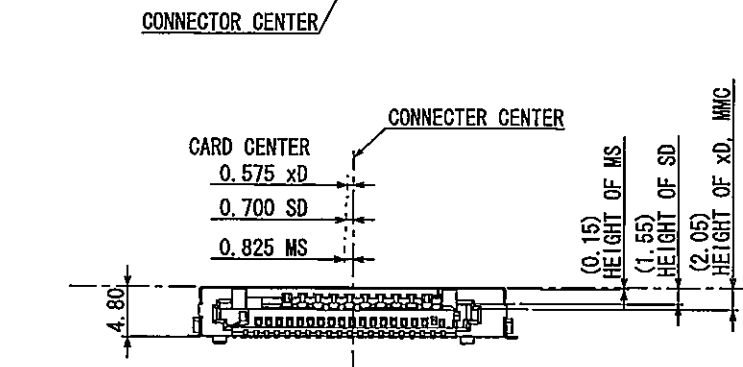
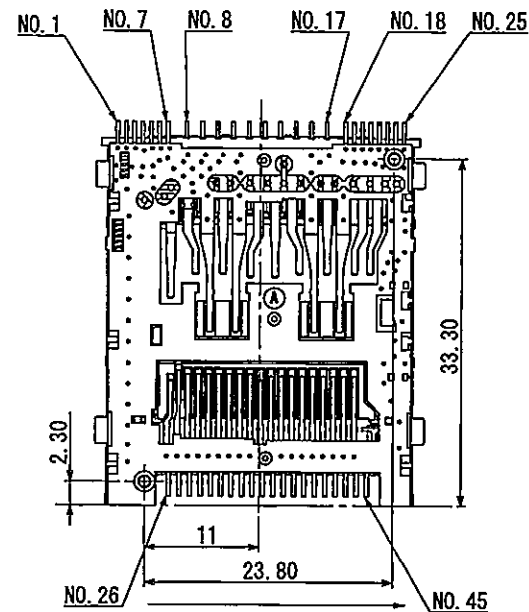
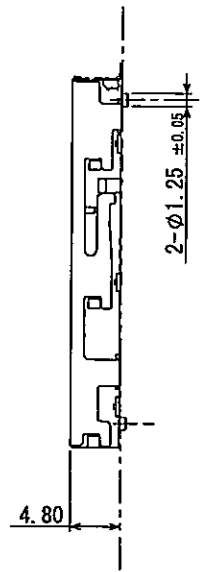
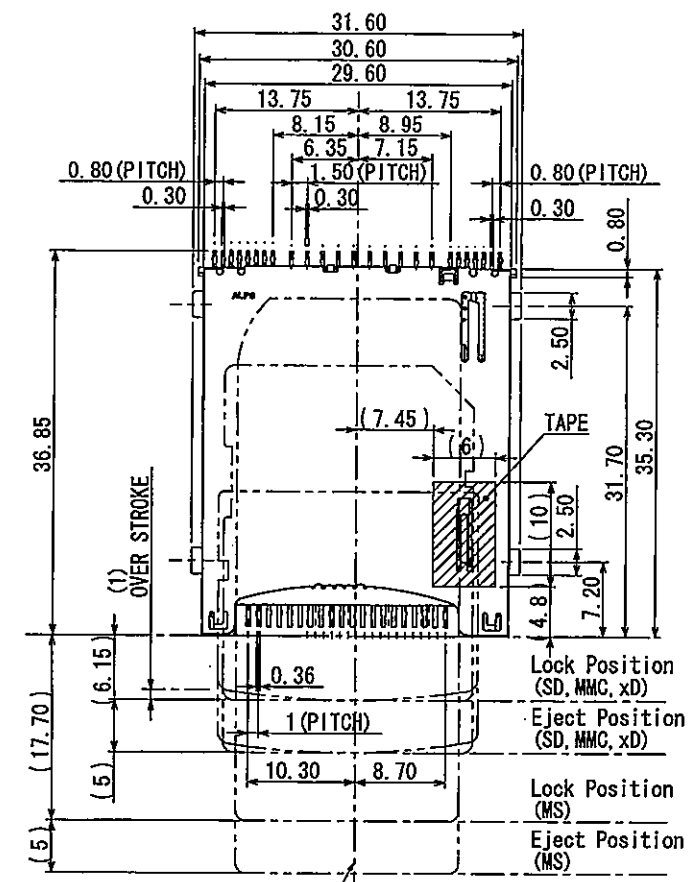

Number	FOR	Pin assign	Function
1	SD	#9	SD-DAT2
2	SD	#1	SD-CD/DAT3
3	MMC Plus	#10	MMC-DAT4
4	SD	#2	SD-CMD
5	MMC Plus	#11	MMC-DAT5
6	SD	#3	SD-VSS
7	SD	#4	SD-VDD
8	MemoryStick	#10	MS-VSS
9	MemoryStick	#9	MS-VCC
10	MemoryStick	#8	MS-SCLK
11	MemoryStick	#7	MS-DATA3
12	MemoryStick	#8	MS-INS
13	MemoryStick	#5	MS-DATA2
14	MemoryStick	#4	MS-DATA0
15	MemoryStick	#3	MS-DATA1
16	MemoryStick	#2	MS-BS
17	MemoryStick	#1	MS-VSS
18	SD	#5	SD-CLK
19	MMC Plus	#12	MMC-DAT6
20	SD	#6	SD-VSS
21	MMC Plus	#13	MMC-DAT7
22	SD	#7	SD-DAT0
23	SD	#8	SD-DAT1
24	SD	SW.COM	SD-COM(SW)
25	SD	SW.CD	SD-CD(SW)
26	xD	#1	xD-GND
27	xD	#0 (CD)	xD-CD
28	xD	#2	xD-R/-B
29	xD	#3	xD-RE
30	xD	#4	xD-CE
31	xD	#5	xD-CLE
32	xD	#6	xD-ALE
33	xD	#7	xD-WE
34	xD	#8	xD-WP
35	xD	#9	xD-GND
36	xD	#10	xD-D0
37	xD	#11	xD-D1
38	xD	#12	xD-D2
39	xD	#13	xD-D3
40	xD	#14	xD-D4
41	xD	#15	xD-D5
42	xD	#16	xD-D6
43	xD	#17	xD-D7
44	xD	#18	xD-VCC
45	SD	SW.WP	SD-WP(SW)

FOR SD, MMC, MMC Plus, MS (full size), xD
STANDARD MOUNT TYPE
PUSH PUSH EJECT TYPE
HALOGEN FREE

TOLERANCES UNLESS OTHERWISE SPEC.	
BASIC DIMENSION	TOLERANCE
UP TO 10	±0.3
ABOVE 10 TO 100	±0.5
ANGULAR DIMENSION	±3°

ALPS ELECTRIC CO., LTD.

DSGD, Dec. 07, 2010 Y. Arimori	SCALE 2:1	NO. SCDG1A0109
CHKD, Dec. 07, 2010 H. Sasaki	TITLE PRODUCT DRAWING (製品図) (1/3)	
APPLD, Dec. 07, 2010 Y. Okabe	UNIT mm	DOCUMENT NO. SCDG1A0109, AE13, 023

SYMB	DATE	APPD	CHKD	DSGD
△4	May. 17, 2011	H.S.	H.S.	Y.A.
△2	Jan. 25, 2011	Y.O.	H.S.	Y.A.

PRELIMINARY

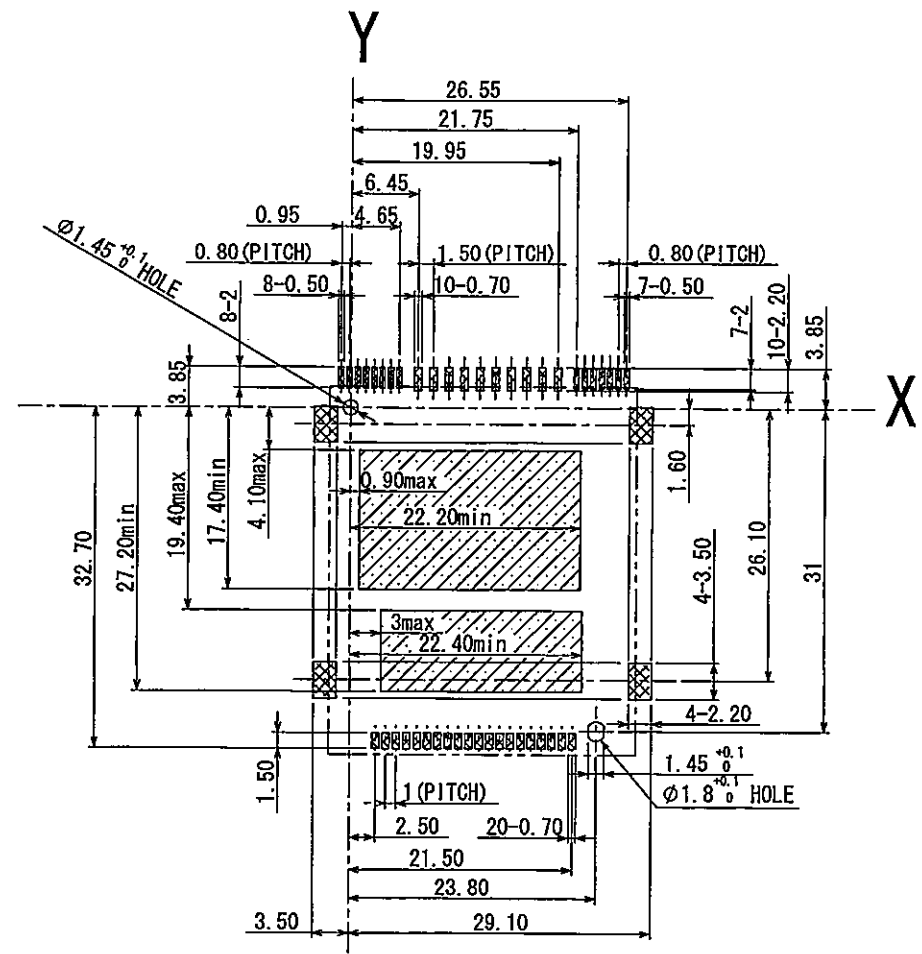

 LAND AREA
  NO PATTERN AREA

Recommended P.C. Board layout (Mounting face side)
 TOLERANCES UNLESS OTHERWISE SPEC. ±0.05

					ALPS ELECTRIC CO., LTD.		
		DSGD. Dec. 07. 2010 Y. Arimori	SCALE 2:1			NO. SCDG1A0109	
		CHKD. Dec. 07. 2010 H. Sasaki				TITLE PRODUCT DRAWING (製品図) (2/3)	
		APPD. Dec. 07. 2010 Y. Okabe	UNIT mm			DOCUMENT NO. SCDG1A0109, AE23, 023	
SYMB	DATE	APPD	CHKD	DSGD			

CARRIER TAPE (2:1)

PRELIMINARY

引き出し方向
PULL OUT DIRECTION

△ DESIGN CHANGE
REEL CORE (1:10)

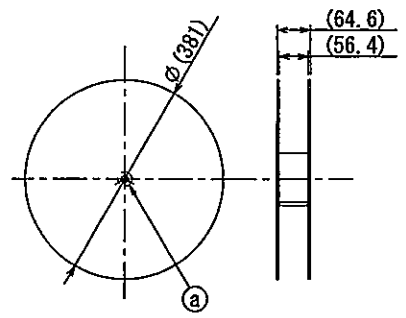

△ DESIGN CHANGE

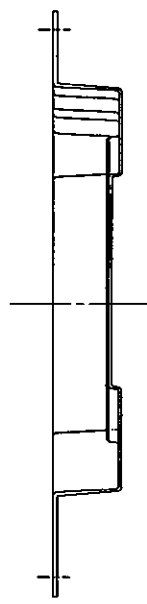
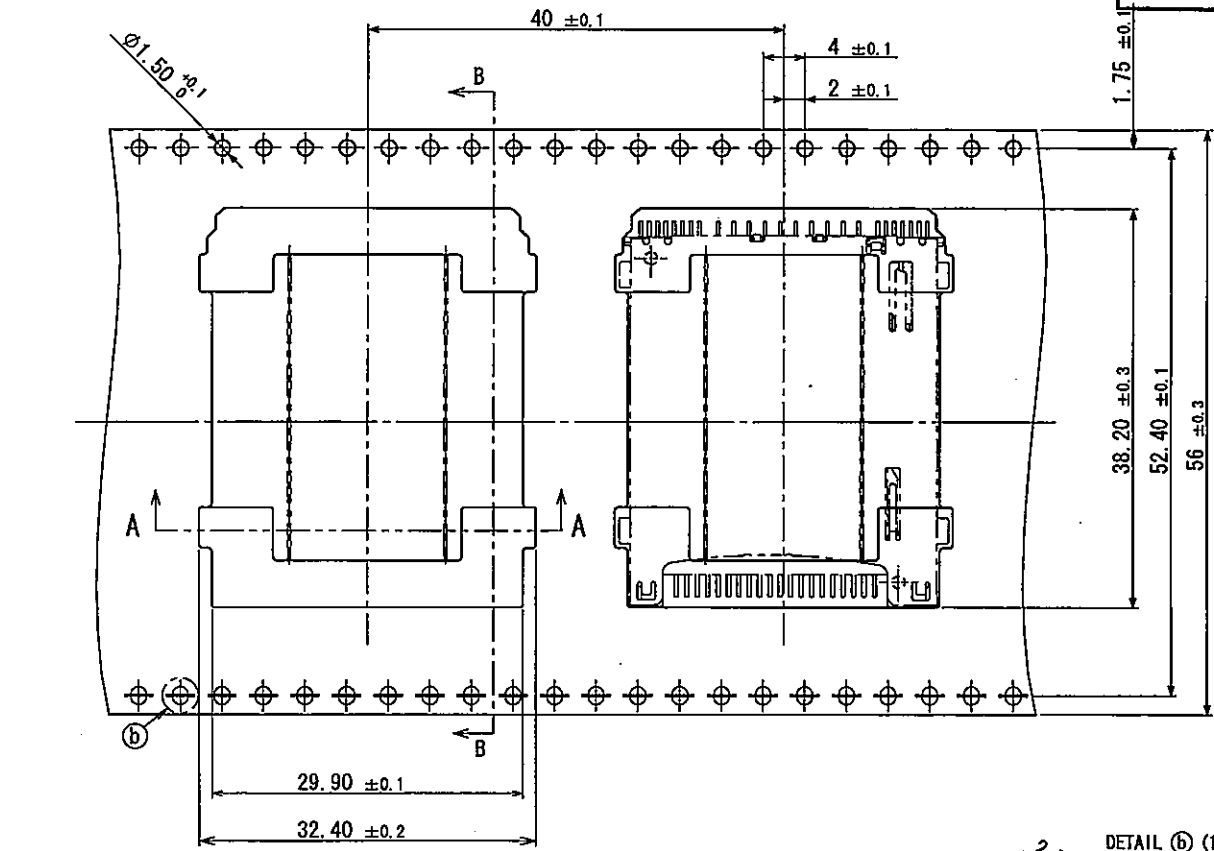
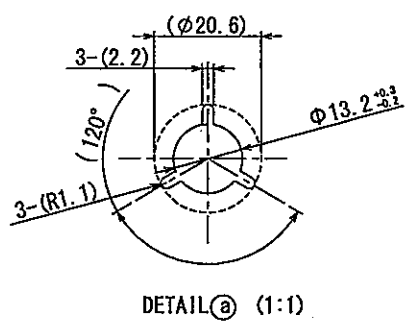

SECTION B-B

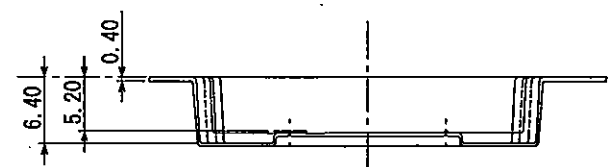

SECTION A-A

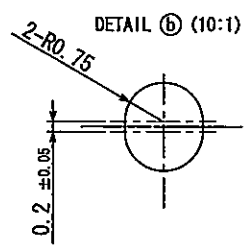

ALPS ELECTRIC CO., LTD.

DSGD. Dec. 07. 2010 Y. Arimori	SCALE 2:1	NO. SCDG1A0109
CHD. Dec. 07. 2010 H. Sasaki		TITLE PRODUCT DRAWING (製品図) (3/3)
APPD. Dec. 07. 2010 Y. Okabe	UNIT mm	DOCUMENT NO. SCDG1A0109, AE33, 023

2. 200 300PIECES / REEL
NOTE 1. SPECIFICATION OF TAPING : TAPE-S-051

SYMB	DATE	APPD	CHD	DSGD

X-ON Electronics

Largest Supplier of Electrical and Electronic Components

Click to view similar products for [Standard Card Edge Connectors](#) category:

Click to view products by [ALPS](#) manufacturer:

Other Similar products are found below :

[6565204-6](#) [PKC-156](#) [1437274-4](#) [147889-1](#) [1489165-4](#) [EBT156-12B1X](#) [EBT15622B2X](#) [EBT156-22R2W](#) [1-582587-1](#) [1-582589-1](#) [2-6437275-9](#) [284-0102-12100](#) [306022901000000](#) [307-012-502-202](#) [307-024-526-201](#) [307-056-520-300](#) [307-080-526-208](#) [1926088-2](#) [245-062-520-350](#) [287-0032-12101](#) [306-010-500-112](#) [306-028-525-102](#) [306-240-318](#) [307-036-502-202](#) [307-036-521-301](#) [307-072-526-202](#) [345-060-559-303](#) [368-004-520-201](#) [392-008-559-201](#) [534671-1](#) [5-530501-5](#) [341-240-317](#) [345-029-520-300](#) [345-030-500-301](#) [345-044-500-300](#) [345-220-058](#) [346-240-318](#) [357-030-526-201](#) [387-012-523-300](#) [395-044-520-300](#) [395-100-524-300](#) [50-12B-10](#) [50-6SN-5](#) [09-07-2032](#) [10035388-106LF](#) [10035388-802LF](#) [10115859-011LF](#) [10122859-009LF](#) [101269333204245CLF](#) [10127905-B04B24BLF](#)