





BACK GROUND
SCDA9A0200

PRELIMINARY

Recommended P.C.B layout
(Mounting face side)

-  LAND
-  NO PART AREA
-  NO PATTERN AREA
-  NO PATTERN EXPOSE AREA

Circuit Diagram for Detect SW

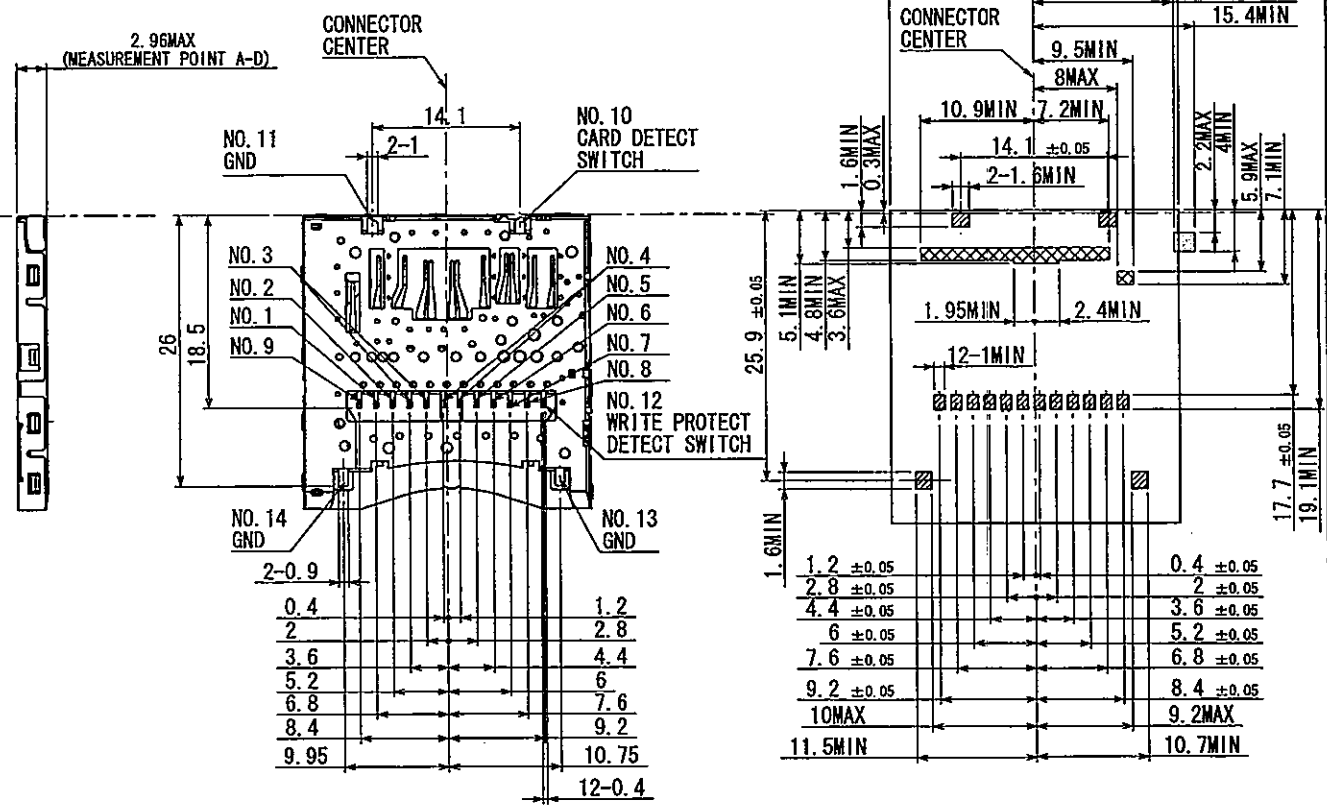
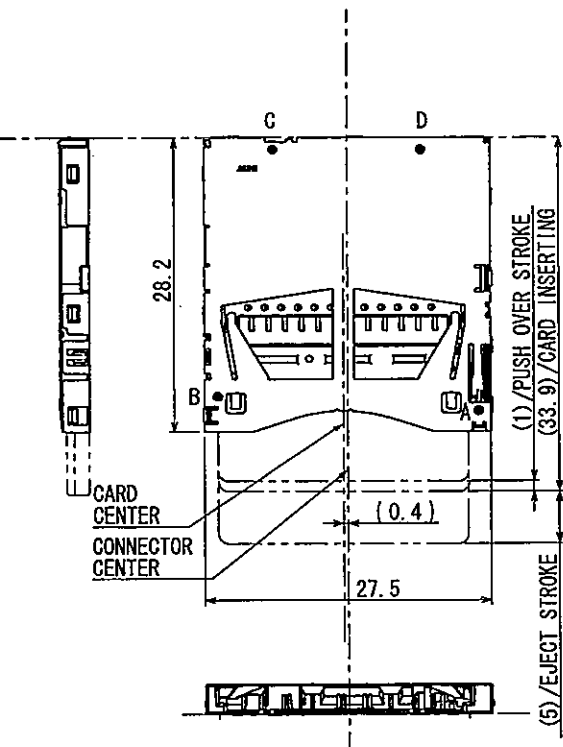
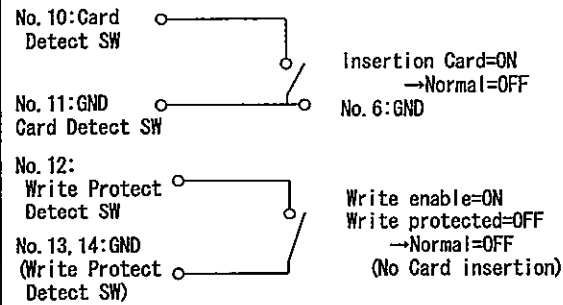

ALPS ELECTRIC CO., LTD.

NOTES 1) ALL TERMINALS COPLANARITY:0.1MAX. (INITIAL)
 2) THE HEIGHT OF THE PRODUCT IS MEASURED WITH DIGITAL HEIGHT GAUGE.

TOLERANCES UNLESS OTHERWISE SPEC		DSGD	Sep. 26. 2009	SCALE	NO.
BASIC DIMENSIONS			N. ISHIKAWA		
UP TO 10	±0.3	CHKD.	Sep. 26. 2009		TITLE
ABOVE 10 TO 100	±0.5		H. Sasaki		PRODUCT DRAWING (1/2)
ABOVE 100	±0.8	APPD.	Sep. 26. 2009	UNIT	DOCUMENT NO.
ANGULAR DIMENSION	±5°	SYMB	Y. Kuroda	mm	SCDA9A0200, AE12, 003

PRELIMINARY

CARRIER TAPE (2:1)

REEL CORE (1:5)

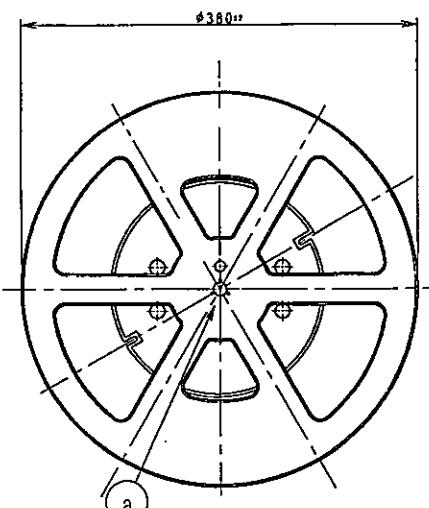

DETAIL @ (1:1)

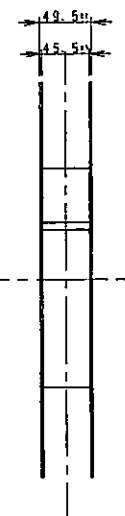
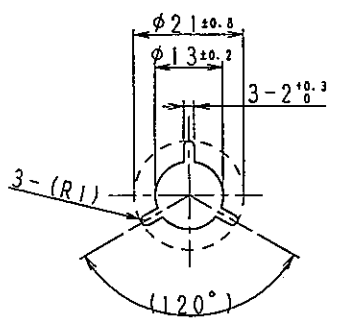

DETAIL @ (10:1)

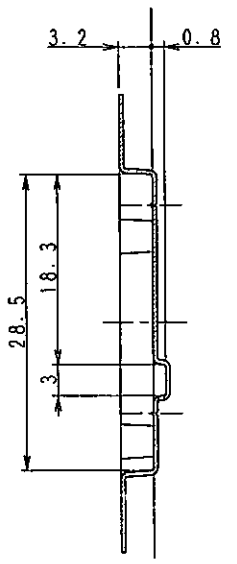
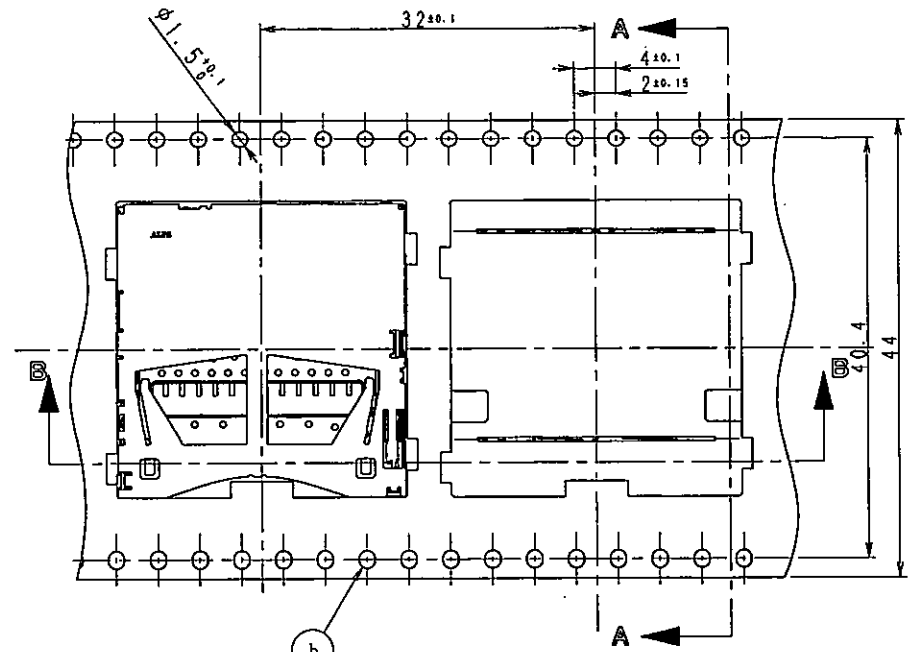
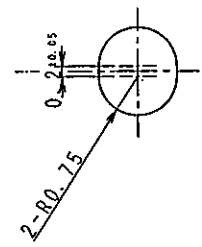

SEC A-A

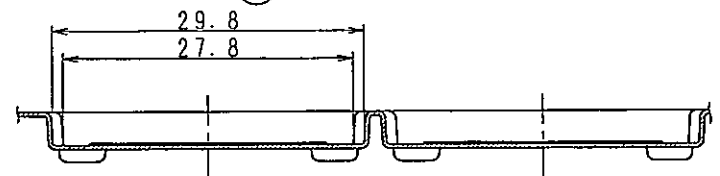

SEC B-B

NOTE 1. SPECIFICATION OF TAPING:TAPE-S-013

TOLERANCES UNLESS OTHERWISE SPEC.	
10 UNDER	±0.3
ABOVE 10 TO 100	±0.5
ANGULAR DIMENSION	±3°

▲						
▲						
▲						
▲						
▲						
▲						
ZONE	SYMB	DATE	APPD	CHKD	DSGD	

ALPS ELECTRIC CO., LTD.

DSGD. Sep. 26, 2009 N. ISHIKAWA	SCALE /	MODEL NO. (部品番) SCDA9A0200 (2/2)
CHKD. Sep. 26, 2009 H. Sasaki	UNIT mm	TITLE (TAPING) PRODUCT DRAWING (部品図)
APPD. Sep. 26, 2009 J. Kuroda		DOCUMENT NO. SCDA9A0200, AE22.003

FOLD 5

FOLD 5

X-ON Electronics

Largest Supplier of Electrical and Electronic Components

Click to view similar products for [Standard Card Edge Connectors](#) category:

Click to view products by [ALPS](#) manufacturer:

Other Similar products are found below :

[6565204-6](#) [PKC-156](#) [1437274-4](#) [147889-1](#) [1489165-4](#) [EBT156-12B1X](#) [EBT15622B2X](#) [EBT156-22R2W](#) [1-582587-1](#) [1-582589-1](#) [2-6437275-9](#) [284-0102-12100](#) [306022901000000](#) [307-012-502-202](#) [307-024-526-201](#) [307-056-520-300](#) [307-080-526-208](#) [1926088-2](#) [245-062-520-350](#) [287-0032-12101](#) [306-010-500-112](#) [306-028-525-102](#) [306-240-318](#) [307-036-502-202](#) [307-036-521-301](#) [307-072-526-202](#) [345-060-559-303](#) [368-004-520-201](#) [392-008-559-201](#) [534671-1](#) [5-530501-5](#) [341-240-317](#) [345-029-520-300](#) [345-030-500-301](#) [345-044-500-300](#) [345-220-058](#) [346-240-318](#) [357-030-526-201](#) [387-012-523-300](#) [395-044-520-300](#) [395-100-524-300](#) [50-12B-10](#) [50-6SN-5](#) [09-07-2032](#) [10035388-106LF](#) [10035388-802LF](#) [10115859-011LF](#) [10122859-009LF](#) [101269333204245CLF](#) [10127905-B04B24BLF](#)