

SSL Series

Features

- RoHS, Halogen Free and REACH Compliance
- Unshielded power inductor
- Various package size and wide inductance range. SSL-HC family is designed for low resistance and high current purpose

Applications

- DC/DC converters

Product Identification



- Packaging: T : Tape and Reel , B : Bulk

Shape and Dimensions

SSL0402



Dimensions in mm

| A | B | C | D | E | F |
|--------------------|--------------------|--------------------|------|------|------|
| 6.60 ⁺⁰ | 4.45 ⁺⁰ | 2.92 ⁺⁰ | 1.02 | 1.27 | 4.32 |

Recommended Pattern

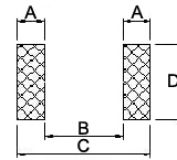

Dimensions in mm

| TYPE | A | B | C | D |
|---------|------|------|------|------|
| SSL0402 | 1.40 | 4.06 | 6.86 | 3.56 |

SSL0804/ 0810

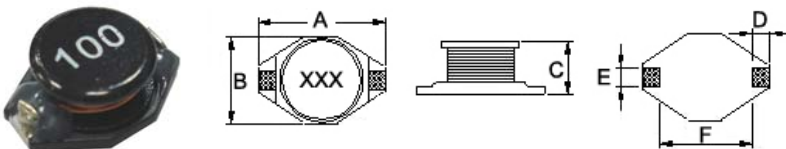

Dimensions in mm

| TYPE | A | B | C | D | E | F |
|---------|---------------------|--------------------|---------------------|------|------|------|
| SSL0804 | 12.95 ⁺⁰ | 9.40 ⁺⁰ | 5.21 ⁺⁰ | 2.54 | 2.54 | 7.62 |
| SSL0810 | 12.95 ⁺⁰ | 9.40 ⁺⁰ | 11.43 ⁺⁰ | 2.54 | 2.54 | 7.62 |

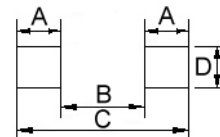

Dimension in mm

| TYPE | A | B | C | D |
|---------|------|------|-------|------|
| SSL0804 | 2.92 | 7.37 | 13.21 | 2.79 |
| SSL0810 | 2.92 | 7.37 | 13.21 | 2.79 |

SSL1306

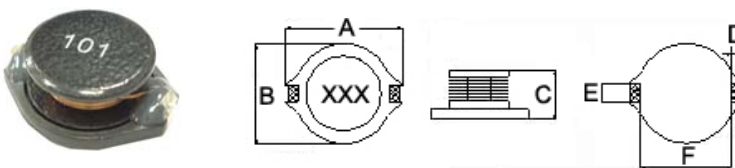

Dimensions in mm

| A | B | C | D | E | F |
|---------------------|---------------------|--------------------|------|------|------|
| 18.54 ⁺⁰ | 15.24 ⁺⁰ | 7.11 ⁺⁰ | 2.54 | 2.54 | 12.7 |

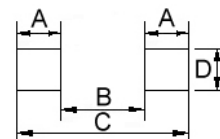

Dimension in mm

| TYPE | A | B | C | D |
|---------|------|-------|-------|------|
| SSL1306 | 2.92 | 12.45 | 18.29 | 2.79 |

Electrical Characteristics

| Part Number | Inductance (μH) | Tolerance ($\pm\%$) | SRF (MHz) Typ. | RDC (Ω) Max | Isat (A) | Irms (A) |
|-----------------|---------------------------------|--------------------------|-------------------|-------------------------|-------------|-------------|
| SSL0402T-1R0M-N | 1.0 | 20 | 130 | 0.05 | 2.90 | 2.9 |
| SSL0402T-1R5M-N | 1.5 | 20 | 115 | 0.05 | 2.60 | 2.8 |
| SSL0402T-2R2M-N | 2.2 | 20 | 90 | 0.07 | 2.30 | 2.4 |
| SSL0402T-3R3M-N | 3.3 | 20 | 70 | 0.08 | 2.00 | 2.0 |
| SSL0402T-4R7M-N | 4.7 | 20 | 50 | 0.09 | 1.50 | 1.5 |
| SSL0402T-5R6M-N | 5.6 | 20 | 47 | 0.11 | 1.30 | |
| SSL0402T-6R8M-N | 6.8 | 20 | 45 | 0.13 | 1.20 | 1.4 |
| SSL0402T-100M-N | 10 | 20 | 35 | 0.16 | 1.10 | 1.1 |
| SSL0402T-150M-N | 15 | 20 | 30 | 0.23 | 0.90 | 1.2 |
| SSL0402T-220M-N | 22 | 20 | 20 | 0.37 | 0.70 | 0.8 |
| SSL0402T-330M-N | 33 | 20 | 15 | 0.51 | 0.58 | 0.6 |
| SSL0402T-470M-N | 47 | 20 | 14 | 0.64 | 0.50 | 0.5 |
| SSL0402T-680M-N | 68 | 20 | 11 | 0.86 | 0.40 | 0.4 |
| SSL0402T-101M-N | 100 | 20 | 9 | 1.27 | 0.31 | 0.3 |
| SSL0402T-151M-N | 150 | 20 | 6 | 2.00 | 0.27 | 0.25 |
| SSL0402T-221M-N | 220 | 20 | 5.5 | 3.11 | 0.22 | 0.20 |
| SSL0402T-331M-N | 330 | 20 | 5 | 3.80 | 0.18 | 0.16 |
| SSL0402T-471M-N | 470 | 20 | 4 | 5.06 | 0.16 | 0.15 |
| SSL0402T-681M-N | 680 | 20 | 3 | 9.20 | 0.14 | 0.12 |
| SSL0402T-102M-N | 1000 | 20 | 2 | 13.8 | 0.10 | 0.07 |

Note: When ordering, please specify tolerance code. Tolerance: M= $\pm 20\%$

- Operating temperature range - 40°C ~ 125°C(Including self - temperature rise)
- Isat for Inductance drop 20% from its value without current
- I rms for a 30°C temperature rise from 25°C ambient with current
- Measure Equipment :

L : E4980 or HP4284A , 100kHz 0.1V

SRF : HP4291A or HP4192A

RDC : CHEN HWA 502

Isat : HP4284A+HP42841A or WK3260B+WK3265B

Test Instruments :

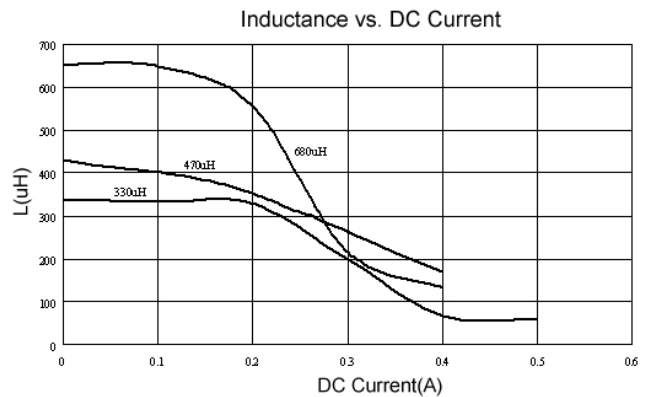
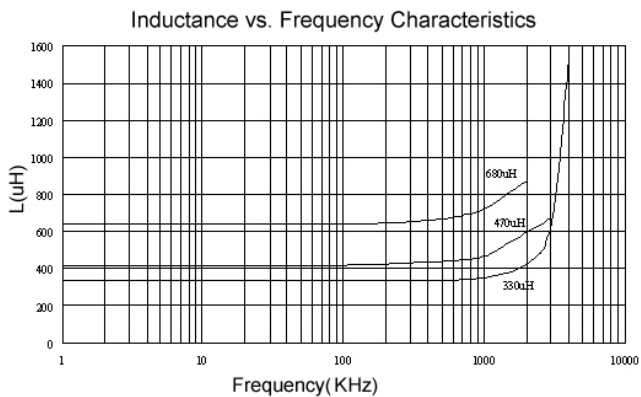

Please be sure to request approval specifications that provide further details of the products. Kindly note that the content of these specifications are subject to change or may be discontinued without advance notice. Please contact our sales department before ordering.

Electrical Characteristics

| Part Number | Inductance (μH) | Tolerance ($\pm\%$) | SRF (MHz) Typ. | RDC (Ω) Max | Isat (A) | Irms (A) |
|-----------------|---------------------------------|--------------------------|-------------------|-------------------------|-------------|-------------|
| SSL0804T-1R0M-N | 1.0 | 20 | 100 | 0.009 | 9.0 | 6.8 |
| SSL0804T-1R5M-N | 1.5 | 20 | 90 | 0.010 | 8.0 | 6.4 |
| SSL0804T-2R2M-N | 2.2 | 20 | 80 | 0.012 | 7.0 | 6.1 |
| SSL0804T-3R3M-N | 3.3 | 20 | 65 | 0.015 | 6.4 | 5.4 |
| SSL0804T-4R7M-N | 4.7 | 20 | 45 | 0.018 | 5.4 | 4.8 |
| SSL0804T-6R8M-N | 6.8 | 20 | 38 | 0.027 | 4.6 | 4.4 |
| SSL0804T-100M-N | 10 | 20 | 30 | 0.038 | 3.8 | 3.9 |
| SSL0804T-120M-N | 12 | 20 | 27 | 0.0432 | 3.5 | 3.6 |
| SSL0804T-150M-N | 15 | 20 | 27 | 0.046 | 3.0 | 3.1 |
| SSL0804T-220M-N | 22 | 20 | 19 | 0.085 | 2.6 | 2.7 |
| SSL0804T-330M-N | 33 | 20 | 15 | 0.100 | 2.0 | 2.1 |
| SSL0804T-470M-N | 47 | 20 | 12 | 0.140 | 1.6 | 1.8 |
| SSL0804T-680M-N | 68 | 20 | 10 | 0.200 | 1.4 | 1.5 |
| SSL0804T-101M-N | 100 | 20 | 9 | 0.260 | 1.2 | 1.3 |
| SSL0804T-151M-N | 150 | 20 | 6 | 0.400 | 1.0 | 1.0 |
| SSL0804T-221M-N | 220 | 20 | 5 | 0.610 | 0.8 | 0.8 |
| SSL0804T-331M-N | 330 | 20 | 4.5 | 1.020 | 0.6 | 0.6 |
| SSL0804T-471M-N | 470 | 20 | 3.5 | 1.270 | 0.5 | 0.5 |
| SSL0804T-681M-N | 680 | 20 | 2.5 | 2.020 | 0.4 | 0.4 |
| SSL0804T-102M-N | 1000 | 20 | 2.0 | 3.000 | 0.3 | 0.3 |
| SSL0804T-152M-N | 1500 | 20 | 1.4 | 4.500 | 0.25 | 0.2 |

Note: When ordering, please specify tolerance code. Tolerance: M= $\pm 20\%$

- Operating temperature range - 40°C ~ 125°C(Including self - temperature rise)
- Isat for Inductance drop 20% from its value without current
- I rms for a 15°C temperature rise from 25°C ambient with current
- Measure Equipment :
 L : E4980 or HP4284A , 100kHz 0.1V
 SRF:HP4291A or HP4192A
 RDC : CHEN HWA 502
 Isat : HP4284A+HP42841A or WK3260B+WK3265B

Test Instruments :

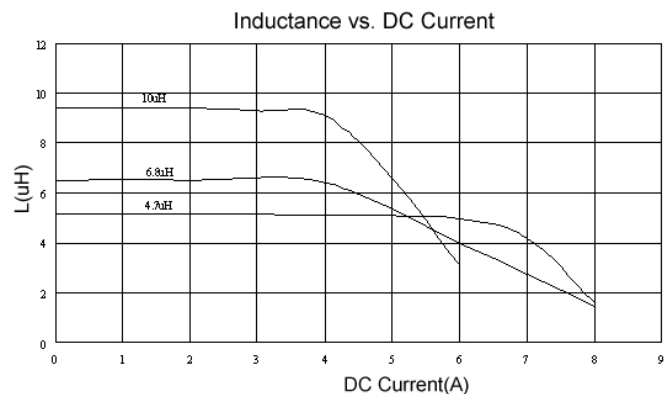
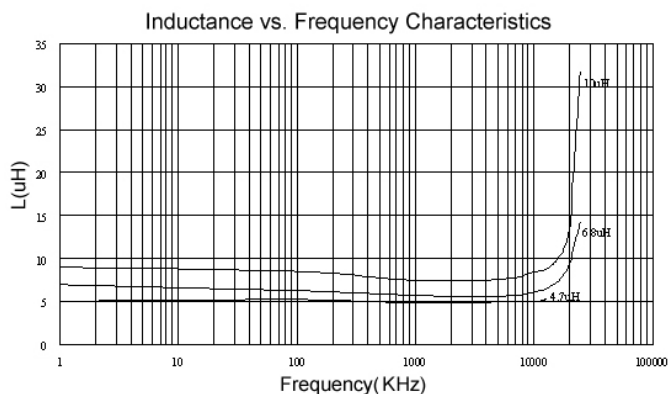

Please be sure to request approval specifications that provide further details of the products. Kindly note that the content of these specifications are subject to change or may be discontinued without advance notice. Please contact our sales department before ordering.

Electrical Characteristics

| Part Number | Inductance (μH) | Tolerance ($\pm\%$) | SRF (MHz) Typ. | RDC (Ω) Max | Isat (A) | Irms (A) |
|-----------------|---------------------------------|--------------------------|-------------------|-------------------------|-------------|-------------|
| SSL0810T-3R3M-N | 3.3 | 20 | 30 | 0.025 | 10 | 4.0 |
| SSL0810T-4R7M-N | 4.7 | 20 | 25 | 0.033 | 8.0 | 3.5 |
| SSL0810T-100M-N | 10 | 20 | 22 | 0.033 | 8.0 | 3.5 |
| SSL0810T-150M-N | 15 | 20 | 18 | 0.042 | 7.0 | 3.0 |
| SSL0810T-220M-N | 22 | 20 | 11 | 0.054 | 5.5 | 2.5 |
| SSL0810T-330M-N | 33 | 20 | 9 | 0.08 | 4.0 | 2.0 |
| SSL0810T-470M-N | 47 | 20 | 8 | 0.10 | 3.8 | 1.6 |
| SSL0810T-680M-N | 68 | 20 | 7 | 0.17 | 3.0 | 1.2 |
| SSL0810T-101M-N | 100 | 20 | 5 | 0.22 | 2.5 | 1.2 |
| SSL0810T-151M-N | 150 | 20 | 4 | 0.34 | 2.0 | 0.9 |
| SSL0810T-221M-N | 220 | 20 | 3.5 | 0.44 | 1.6 | 0.7 |
| SSL0810T-271M-N | 270 | 20 | 2.5 | 0.60 | 1.4 | 0.6 |
| SSL0810T-331M-N | 330 | 20 | 2.5 | 0.70 | 1.2 | 0.6 |
| SSL0810T-471M-N | 470 | 20 | 2 | 0.95 | 1.0 | 0.3 |
| SSL0810T-681M-N | 680 | 20 | 2 | 1.2 | 1.0 | 0.2 |
| SSL0810T-102M-N | 1000 | 20 | 1.5 | 2.0 | 0.8 | 0.1 |

Note: When ordering, please specify tolerance code. Tolerance: M= $\pm 20\%$

- Operating temperature range - 40°C ~ 125°C(Including self - temperature rise)
- Isat for Inductance drop 20% from its value without current
- Irms for a 40°C temperature rise from 25°C ambient with current
- Measure Equipment :
 L : E4980 or HP4284A , 100kHz 0.1V
 SRF:HP4291A or HP4192A
 RDC : CHEN HWA 502
 Isat : HP4284A+HP42841A or WK3260B+WK3265B

Test Instruments :

Inductance vs. Frequency Characteristics

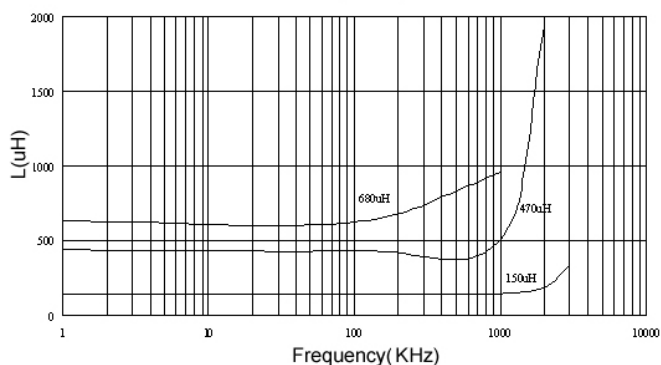

Inductance vs. DC Current

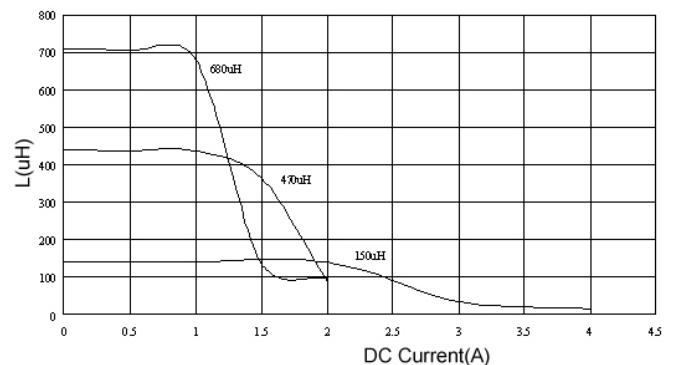

Please be sure to request approval specifications that provide further details of the products. Kindly note that the content of these specifications are subject to change or may be discontinued without advance notice. Please contact our sales department before ordering.

Electrical Characteristics

| Part Number | Inductance (μH) | Tolerance ($\pm\%$) | SRF (MHz) Typ. | RDC ($\Omega+15\%$) | Isat (A) | Irms (A) |
|-----------------|---------------------------------|--------------------------|-------------------|--------------------------|-------------|-------------|
| SSL1306T-1R0M-N | 1.0 | 20 | 80 | 0.011 | 20 | 8.6 |
| SSL1306T-2R2M-N | 2.2 | 20 | 80 | 0.014 | 16 | 7.1 |
| SSL1306T-3R3M-N | 3.3 | 20 | 60 | 0.016 | 14 | 6.2 |
| SSL1306T-4R7M-N | 4.7 | 20 | 45 | 0.022 | 13 | 5.5 |
| SSL1306T-5R6M-N | 5.6 | 20 | 40 | 0.022 | 12 | 5.3 |
| SSL1306T-6R8M-N | 6.8 | 20 | | 0.022 | 10 | |
| SSL1306T-100M-N | 10 | 20 | 30 | 0.032 | 10 | 4.3 |
| SSL1306T-150M-N | 15 | 20 | 22 | 0.036 | 8.0 | 4.0 |
| SSL1306T-180M-N | 18 | 20 | 20 | 0.039 | 7.5 | 3.7 |
| SSL1306T-220M-N | 22 | 20 | 20 | 0.047 | 7.0 | 3.5 |
| SSL1306T-330M-N | 33 | 20 | 15 | 0.066 | 5.5 | 3.0 |
| SSL1306T-470M-N | 47 | 20 | 9 | 0.087 | 4.5 | 2.6 |
| SSL1306T-680M-N | 68 | 20 | 8 | 0.13 | 3.5 | 2.3 |
| SSL1306T-101M-N | 100 | 20 | 7 | 0.19 | 3.0 | 1.8 |
| SSL1306T-151M-N | 150 | 20 | 6 | 0.25 | 2.6 | 1.5 |
| SSL1306T-221M-N | 220 | 20 | 5 | 0.38 | 2.4 | 1.2 |
| SSL1306T-331M-N | 330 | 20 | 4 | 0.56 | 1.9 | 1.0 |
| SSL1306T-471M-N | 470 | 20 | 3 | 0.85 | 1.4 | 0.82 |
| SSL1306T-681M-N | 680 | 20 | 2.5 | 1.2 | 1.2 | 0.72 |
| SSL1306T-102M-N | 1000 | 20 | 2 | 1.8 | 1.0 | 0.56 |

Note: When ordering, please specify tolerance code. Tolerance: M= $\pm 20\%$

- Operating temperature range - 40°C ~ 125°C(Including self - temperature rise)
- Isat for Inductance drop 20% from its value without current
- Irms for a 40°C temperature rise from 25°C ambient with current
- Measure Equipment :
 L : E4980 or HP4284A , 100kHz 0.1V
 SRF:HP4291A or HP4192A
 RDC : CHEN HWA 502
 Isat : HP4284A+HP42841A or WK3260B+WK3265B

Test Instruments :

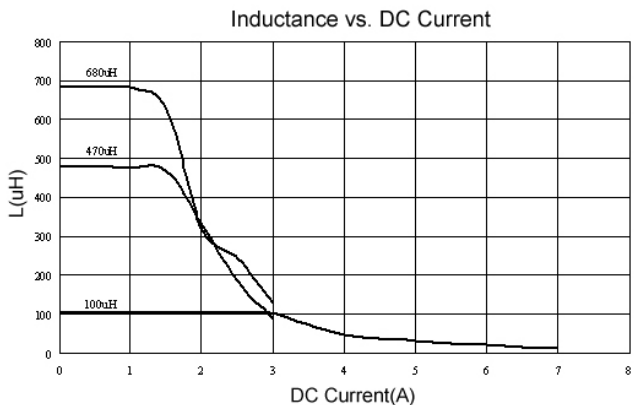
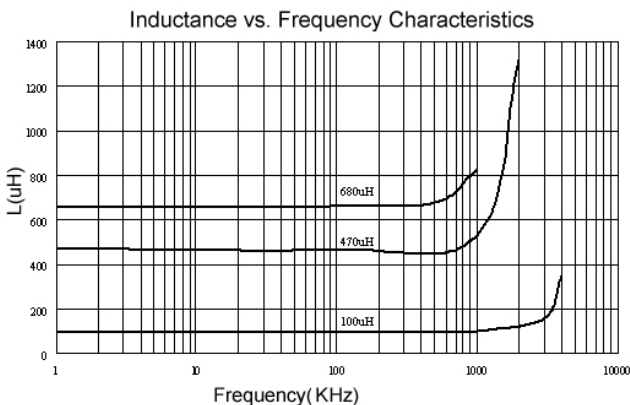

Please be sure to request approval specifications that provide further details of the products. Kindly note that the content of these specifications are subject to change or may be discontinued without advance notice. Please contact our sales department before ordering.

Packaging Specifications

Tape Dimensions

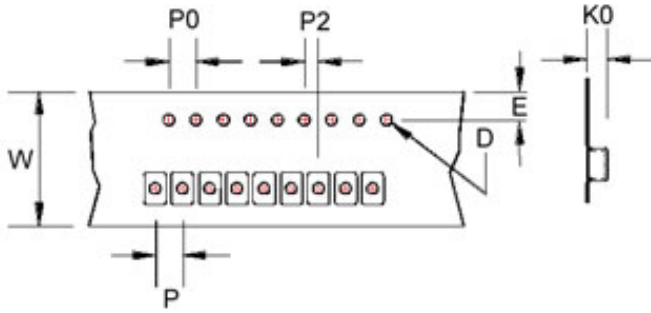

Tape Material

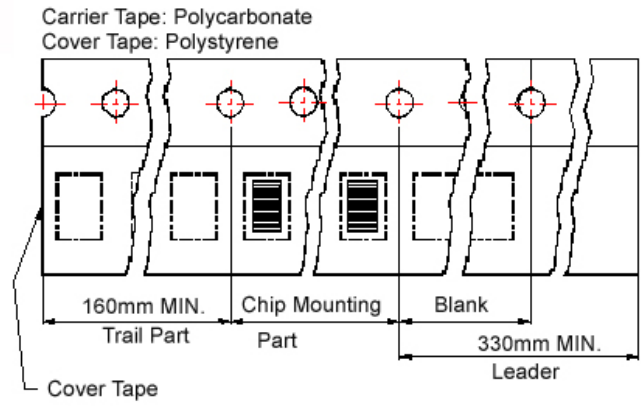

Reel Dimensions

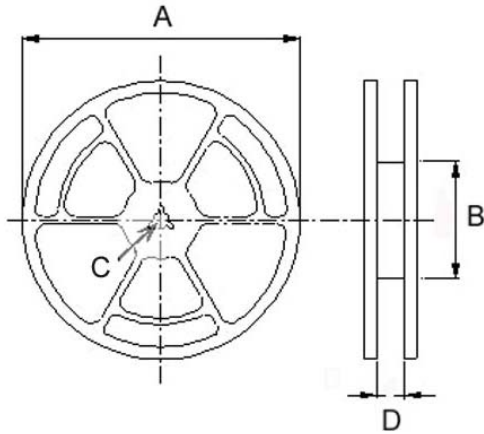

Dimensions in mm

| TYPE | Tape Dimensions | | | | | | | Reel Dimensions | | | | Quantity (PCS / REEL) | |
|----------|-----------------|------|------|----|----|----|----|-----------------|-----|----|------|-----------------------|-------|
| | K0 | D | E | W | P | P0 | P2 | A | B | C | D | 178mm | 330mm |
| SSL0402 | 3.2 | 1.55 | 1.75 | 12 | 8 | 4 | 2 | 330 | 100 | 13 | 13.4 | - | 2500 |
| | | | | | | | | 178 | 60 | | 13.2 | 750 | - |
| SSL 0804 | 5.4 | 1.55 | 1.75 | 24 | 16 | 4 | 2 | 330 | 100 | 13 | 24.4 | - | 750 |
| SSL 0810 | 11.5 | 1.55 | 1.75 | 24 | 20 | 4 | 2 | 330 | 100 | 13 | 24.4 | - | 225 |
| SSL 1306 | 7.5 | 1.55 | 1.75 | 32 | 20 | 4 | 2 | 330 | 100 | 13 | 33.4 | - | 350 |

X-ON Electronics

Largest Supplier of Electrical and Electronic Components

Click to view similar products for [Fixed Inductors](#) category:

Click to view products by [Chilisin](#) manufacturer:

Other Similar products are found below :

[MLZ1608M6R8WTD25](#) [MLZ1608N6R8LT000](#) [MLZ1608N3R3LTD25](#) [MLZ1608N3R3LT000](#) [MLZ1608N150LT000](#)

[MLZ1608M150WTD25](#) [MLZ1608M3R3WTD25](#) [MLZ1608M3R3WT000](#) [MLZ1608M150WT000](#) [MLZ1608A1R5WT000](#)

[MLZ1608N1R5LT000](#) [B82432C1333K000](#) [PCMB053T-1R0MS](#) [PCMB053T-1R5MS](#) [PCMB104T-1R5MS](#) [CR32NP-100KC](#) [CR32NP-](#)

[151KC](#) [CR32NP-180KC](#) [CR32NP-181KC](#) [CR32NP-1R5MC](#) [CR32NP-390KC](#) [CR32NP-3R9MC](#) [CR32NP-680KC](#) [CR32NP-820KC](#)

[CR32NP-8R2MC](#) [CR43NP-390KC](#) [CR43NP-560KC](#) [CR43NP-680KC](#) [CR54NP-181KC](#) [CR54NP-470LC](#) [CR54NP-820KC](#) [CR54NP-8R5MC](#)

[MGDQ4-00004-P](#) [MGDU1-00016-P](#) [MHL1ECTTP18NJ](#) [MHL1JCTTD12NJ](#) [PE-51506NL](#) [PE-53601NL](#) [PE-53630NL](#) [PE-53824SNLT](#) [PE-](#)

[62892NL](#) [PE-92100NL](#) [PG0434.801NLT](#) [PG0936.113NLT](#) [PM06-2N7](#) [PM06-39NJ](#) [HC2LP-R47-R](#) [HC2-R47-R](#) [HC3-2R2-R](#) [HC8-1R2-R](#)