

Specifications

- Current rating:1A AC,DC
- Voltage rating:150V AC,DC
- Temperature range:-40°C~+105°C
- Contact resistance:30mΩMax.
- Insulation resistance:500MΩMin.
- Withstanding voltage:500V AC/minute
- *Compliant with RoHS and REACH*
- *Meet the HF/Halogen Free,need to customize*
- *Contact CJT for details*

Standards



Assembly layout

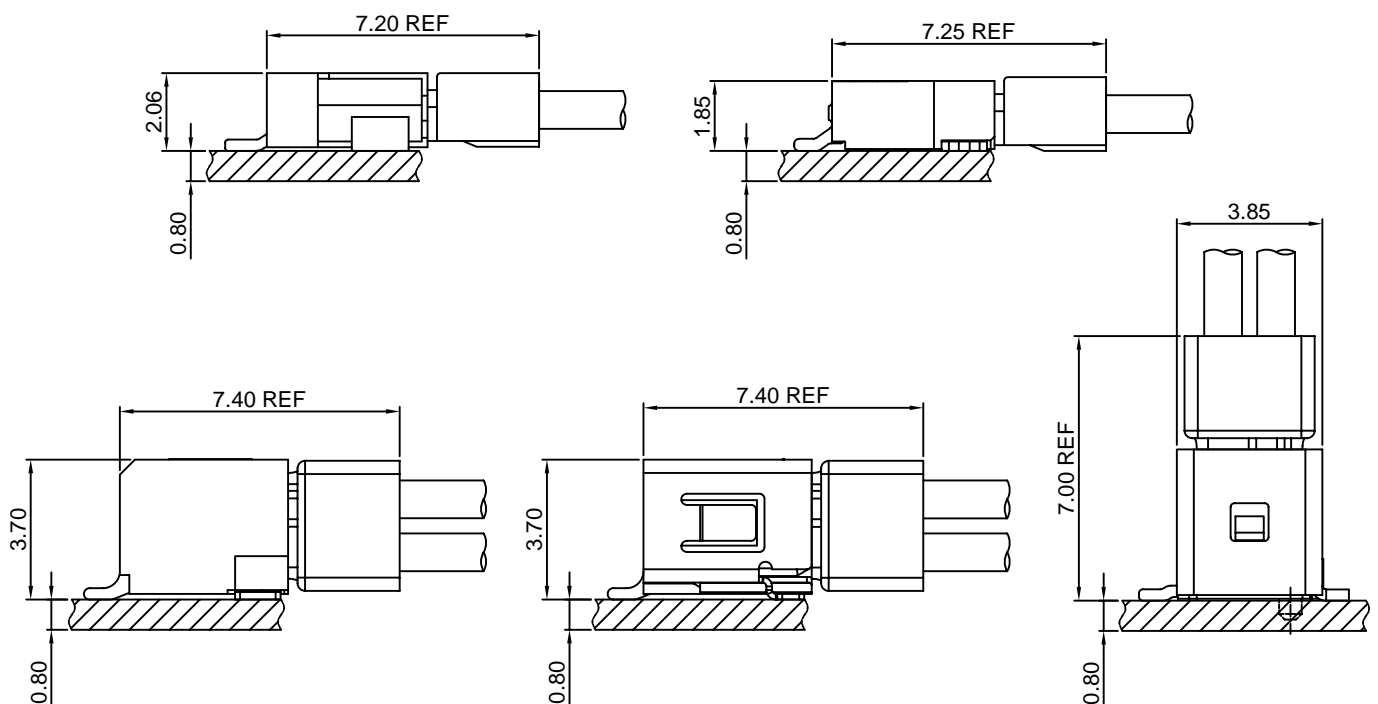

A1256-T

1.25mm pitch Crimp Terminal

Reference Informations:

*Used in CJT A1256H,HD-XP,A1255HA-XP series Housing

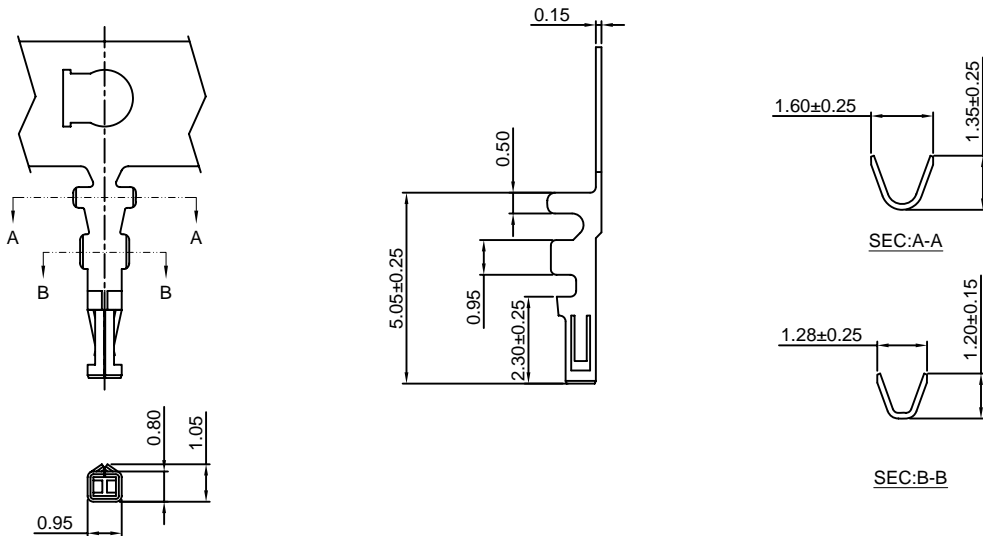

Ordering information & Specifications:

Unit:mm

Part NO	Wire Range	Insulation O.D.	Material	Finish	Qty/reel
A1256-TP	AWG#28-#32	0.90mm(max)	Phosphor Bronze	Tin over Nickel	15,000 PCS
A1256-GP	AWG#28-#32	0.90mm(max)	Phosphor Bronze	Gold over Nickel	15,000 PCS

Optional Gold plating available but MOQ requested

A1256H-XP

1.25mm pitch Housing

Reference Informations:

- *Material:Nylon 66,UL94V-0
- *Suitable CJT A1256-T series Terminal
- *Mates with CJT A1256WR-S,WRA-S-XP series Wafer
- *Color:Black

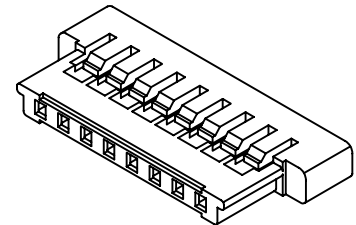

Ordering Information:

A1256H-XP - ***
1 2

- Part No.
- Material:
(Blank):Nylon 66,UL94V-0
GWT:Nylon 66,UL94V-0,GWT 750°C

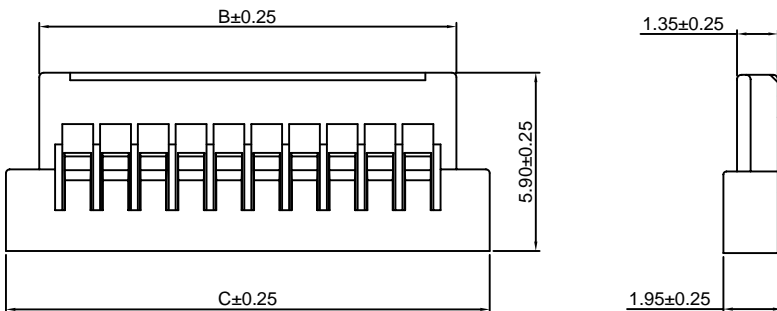
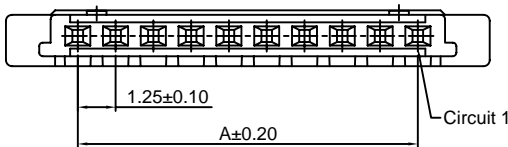

Ordering Information & Dimensions:

PART NO.	Dimensions		
	A	B	C
2P	1.25	3.80	6.00
3P	2.50	5.05	7.25
4P	3.75	6.30	8.50
5P	5.00	7.55	9.75
6P	6.25	8.80	11.00
8P	8.75	11.30	13.50
10P	11.25	13.80	16.00
15P	17.25	20.05	22.25
20P	23.75	26.30	28.50
25P	30.00	32.55	34.75
30P	36.25	38.80	41.00

Unit: mm

A1256HD-XP

1.25mm pitch Dual Row Housing

Reference Informations:

- *Material:Nylon 66,UL94V-0
- *Suitable CJT A1256-T series Terminal
- *Mates with CJT A1256WVD-S-F, WRD-S, WRDA-S-XP series Dual Row Wafer
- *Color:Black

Ordering Information:

- A1256HD-XP - ***
 1 2
- 1.Part No.
 2.Material:
 (Blank):Nylon 66,UL94V-0
 GWT:Nylon 66,UL94V-0,GWT 750 °C

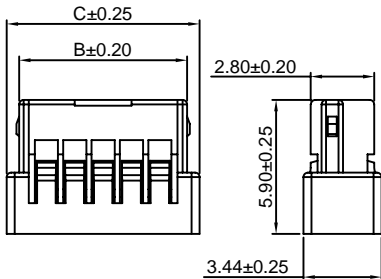
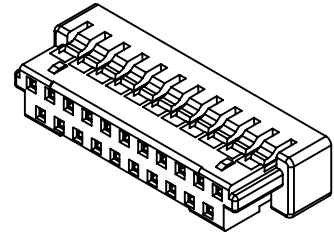
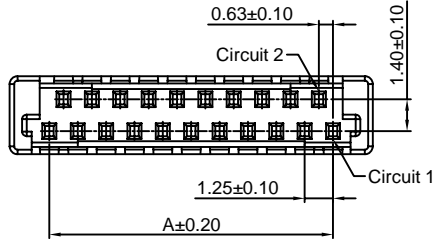
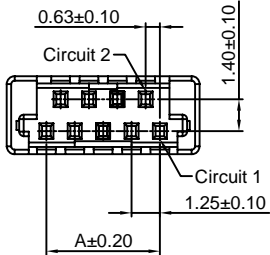

5,7,9,11 Contacts

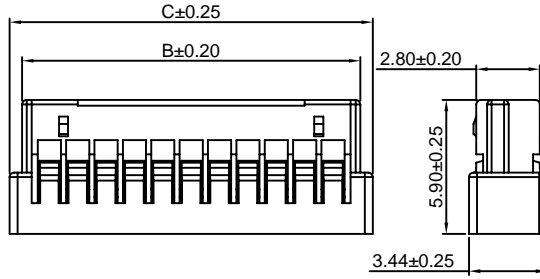

13,15,17,19,21,31,41 Contacts

Ordering Information & Dimensions:

PART NO.	Dimensions		
	A	B	C
5P	2.50	4.90	6.00
7P	3.75	6.15	7.25
9P	5.00	7.40	8.50
11P	6.25	8.65	9.75
13P	7.50	9.90	11.00
15P	8.75	11.15	12.25
17P	10.00	12.40	13.50
19P	11.25	13.65	14.75
21P	12.50	14.90	16.00
31P	18.75	21.15	22.25
41P	25.00	27.60	28.50

Unit: mm

A1256WR-S-XP

1.25mm pitch 90° Wafer-SMT TYPE

Reference Informations:

- *Material:Pin:Brass/Gold over Nickel
Solder Tabs:Brass/Tin over Nickel
Insulator:Nylon 6T,UL94V-0
- *Mates with CJT A1256H-XP series Housing
- *Color:White

Ordering Information:

- A1256WR-S-XP - ***
 1 2
- 1.Part No.
 2.Material:
 (Blank):Nylon 6T,UL94V-0
 GWT:Nylon 6T,UL94V-0,GWT 750 °C

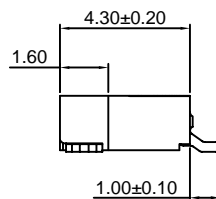
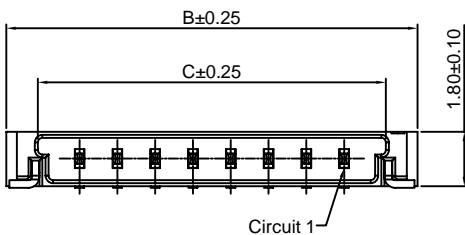
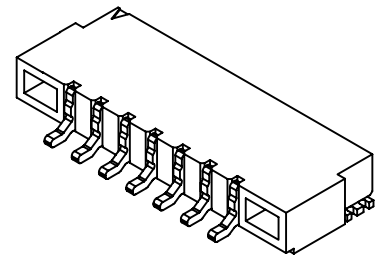
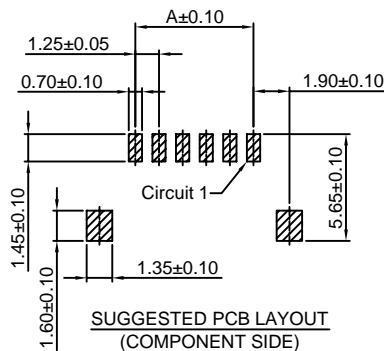
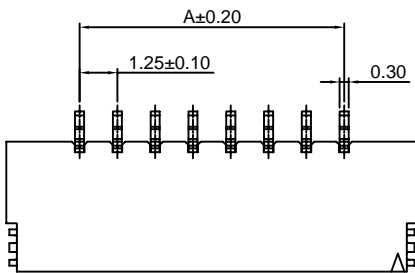

Ordering Information & Dimensions:

PART NO.	Dimensions		
	A	B	C
2P	1.25	6.10	4.01
3P	2.50	7.35	5.26
4P	3.75	8.60	6.51
5P	5.00	9.85	7.76
6P	6.25	11.10	9.01
8P	8.75	13.60	11.51
10P	11.25	16.10	14.01
15P	17.25	22.35	20.26
20P	23.75	28.60	26.51
25P	30.00	34.85	32.76
30P	36.25	41.10	39.01

Unit: mm

A1256WRA-S-XP

1.25mm pitch 90° Wafer-SMT TYPE

Reference Informations:

- *Material: Pin: Brass/Tin over Nickel
Shell: Brass/Tin over Nickel
Insulator: LCP, UL94V-0
- *Mates with CJT A1256H-XP series Housing
- *Color: White

Ordering Information:

- A1256WRA-S-XP - *** - **
 1 2 3
1. Part No.
 2. Material:
(Blank): LCP, UL94V-0
GWT: LCP, UL94V-0, GWT 750 °C
 3. Finish:
(Blank): Tin over Nickel
G: Gold over Nickel

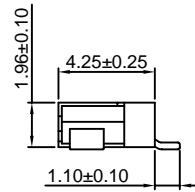
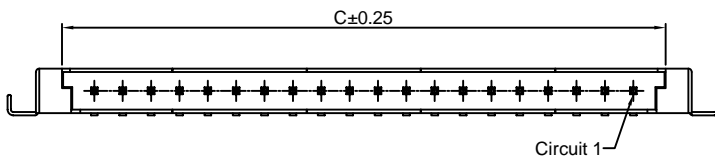
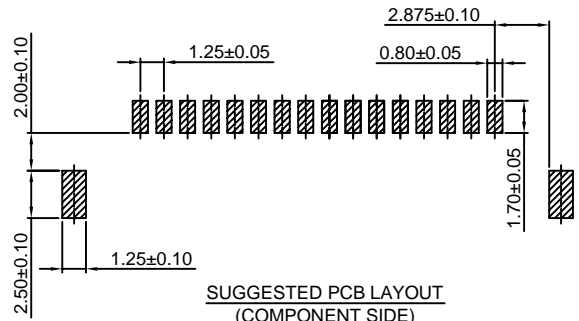
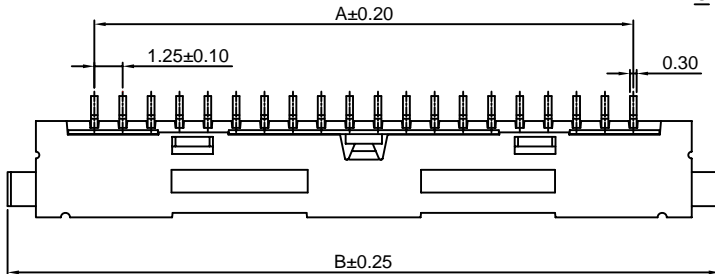
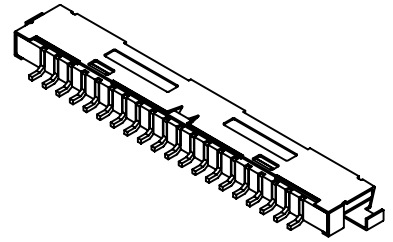

Ordering Information & Dimensions:

PART NO.	Dimensions		
	A	B	C
20P	23.75	31.40	26.60
30P	36.25	43.60	39.10

Unit: mm

A1256WVD-S-F-XP

1.25mm Pitch 180° Dual Row Wafer-SMT TYPE

Reference Informations:

- *Material: Pin: Brass/Gold over Nickel
Shell: Brass/Tin over Nickel
Insulator: Nylon 6T, UL94V-0
Cap: Nylon 6T, UL94V-0
- *Mates with CJT A1256HD-XP series Dual Row Housing
- *Color: White

Ordering Information:

- A1256WVD-S-F-XP - ***
 1 2
1. Part No.
 2. Material:
(Blank): Nylon 6T, UL94V-0
GWT: Nylon 6T, UL94V-0, GWT 750 °C

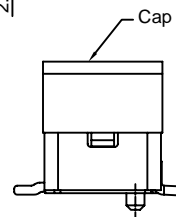
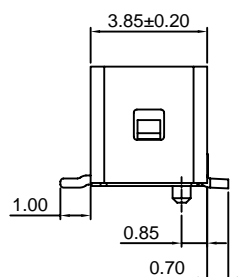
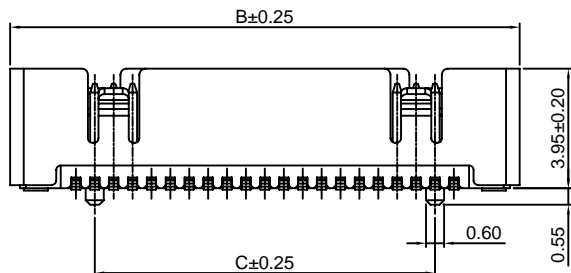
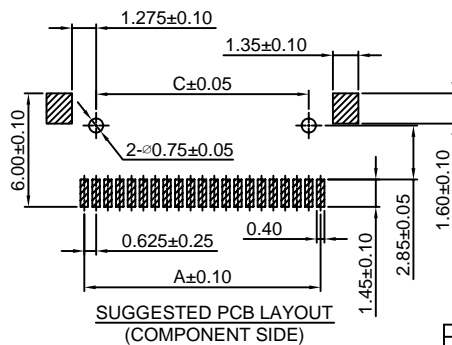
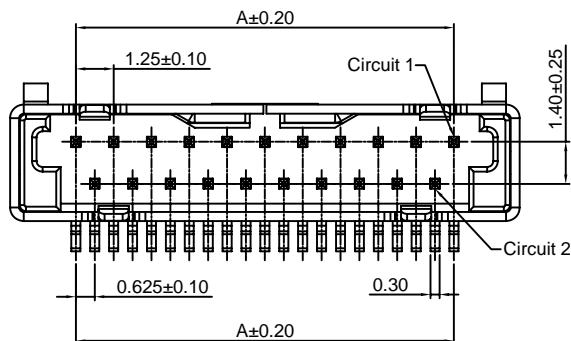
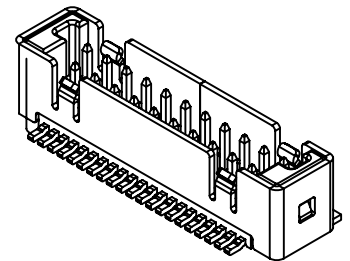

Ordering Information & Dimensions:

PART NO.	Dimensions		
	A	B	C
21P	12.50	16.85	11.25
31P	18.75	23.10	17.50

Unit: mm

A1256WRD-S-XP

1.25mm Pitch 90° Dual Row Wafer-SMT TYPE

Reference Informations:

- *Material: Pin: Brass/Gold over Nickel
Shell: Brass/Tin over Nickel
Insulator: Nylon 6T, UL94V-0
- *Mates with CJT A1256HD-XP series Dual Row Housing
- *Color: White

Ordering Information:
A1256WRD-S-XP - ***
 1 2
 1. Part No.
 2. Material:
 (Blank): Nylon 6T, UL94V-0
 GWT: Nylon 6T, UL94V-0, GWT 750 °C

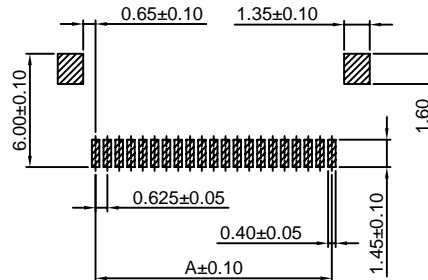
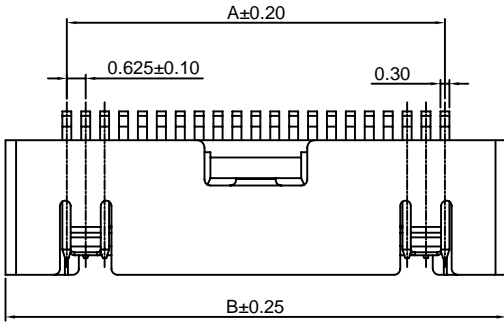
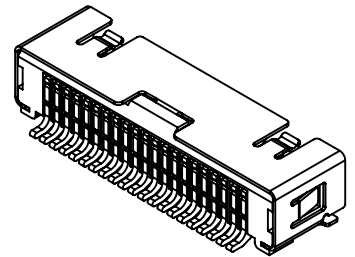

SUGGESTED PCB LAYOUT
(COMPONENT SIDE)

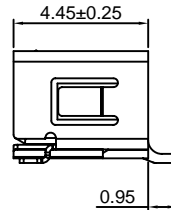
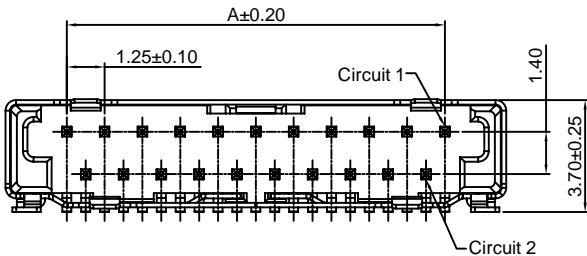

Ordering Information & Dimensions:

PART NO.	Dimensions	
	A	B
21P	12.50	16.55
31P	18.75	22.80
41P	25.00	29.05

Unit: mm

A1256WRDA-S-XP

1.25mm pitch 90° Dual Row Wafer-SMT TYPE

Reference Informations:

- *Material: Pin: Brass/Gold over Nickel
Solder Tabs: Brass/Tin over Nickel
Insulator: Nylon 6T, UL94V-0
- *Mates with CJT A1256HD-XP series dual row Housing
- *Color: White

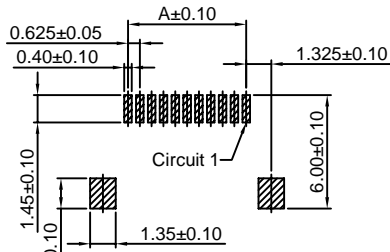

Ordering Information:
A1256WRDA-S-XP - ***
 1 2
 1. Part No.
 2. Material:
 (Blank): Nylon 6T, UL94V-0
 GWT: Nylon 6T, UL94V-0, GWT 750 °C

SUGGESTED PCB LAYOUT
(COMPONENT SIDE)

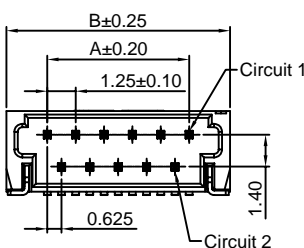
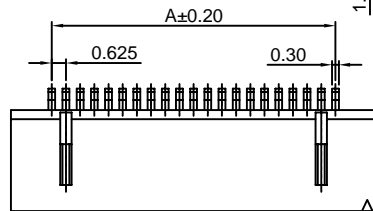
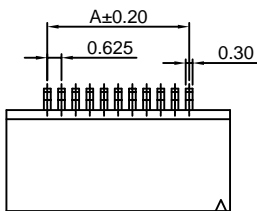

5,7,9,11 Contacts

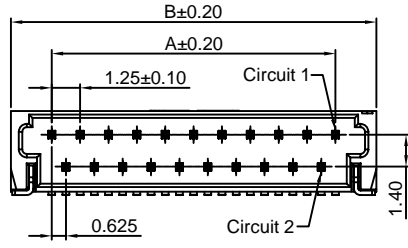

13,15,17,19,21,31,41 Contacts

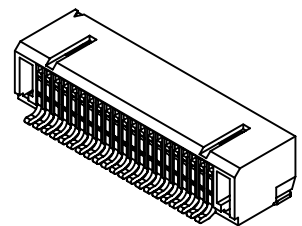
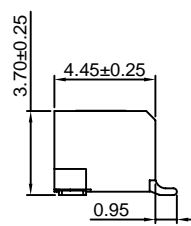

Ordering Information & Dimensions:

PART NO.	Dimensions	
	A	B
5P	2.50	6.10
7P	3.75	7.35
9P	5.00	8.60
11P	6.25	9.85
13P	7.50	11.10
15P	8.75	12.35
17P	10.00	13.60
19P	11.25	14.85
21P	12.50	16.10
31P	18.75	22.35
41P	25.00	28.60

Unit: mm

X-ON Electronics

Largest Supplier of Electrical and Electronic Components

Click to view similar products for [Headers & Wire Housings](#) category:

Click to view products by [Changjiang](#) manufacturer:

Other Similar products are found below :

[95000-104TRLF](#) [10135584-644402LF](#) [DF62W-EP2022PCA](#) [95000-106TRLF](#) [DF62W-2022SCA](#) [DF62W-EP2022PC](#) [2203348](#) [DF62W-2022SC](#) [1084018](#) [1029039](#) [1084017](#) [802-10-012-10-002000](#) [1112640](#) [1112639](#) [891-007-9SS-BST1T](#) [000-34000](#) [0008550134](#) [0009482033](#) [0009507031](#) [57102-F02-18ULF](#) [57102-S06-03LF](#) [57202-S52-04LF](#) [PCN6-15S-2.5E](#) [0039019024](#) [58102-G61-06LF](#) [582553-1](#) [0009485154](#) [0009508121](#) [0022285053](#) [0050291907](#) [018731A](#) [LY20-4P-DT1-P1E-BR](#) [02.125.8002.8](#) [60101931](#) [60598-1 \(Cut Strip\)](#) [M1625-3R/100](#) [61062-3](#) [61082-181009](#) [CSU011177004](#) [636-1427](#) [638009-1](#) [641938-9](#) [641991-4](#) [644168-1](#) [644827-2](#) [647662-1](#) [65039-019ELF](#) [65692-001LF](#) [65781-018](#) [65781-047](#)