

Specifications

- Current rating: 1A AC, DC
- Voltage rating: 150V AC, DC
- Temperature range: -40°C ~ +105°C
- Contact resistance: 30mΩ Max.
- Insulation resistance: 500MΩ Min.
- Withstanding voltage: 500V AC/minute
- *Compliant with RoHS and REACH*
- *Meet the HF/Halogen Free, need to customize*
- *Contact CJT for details*

Standards



Assembly layout

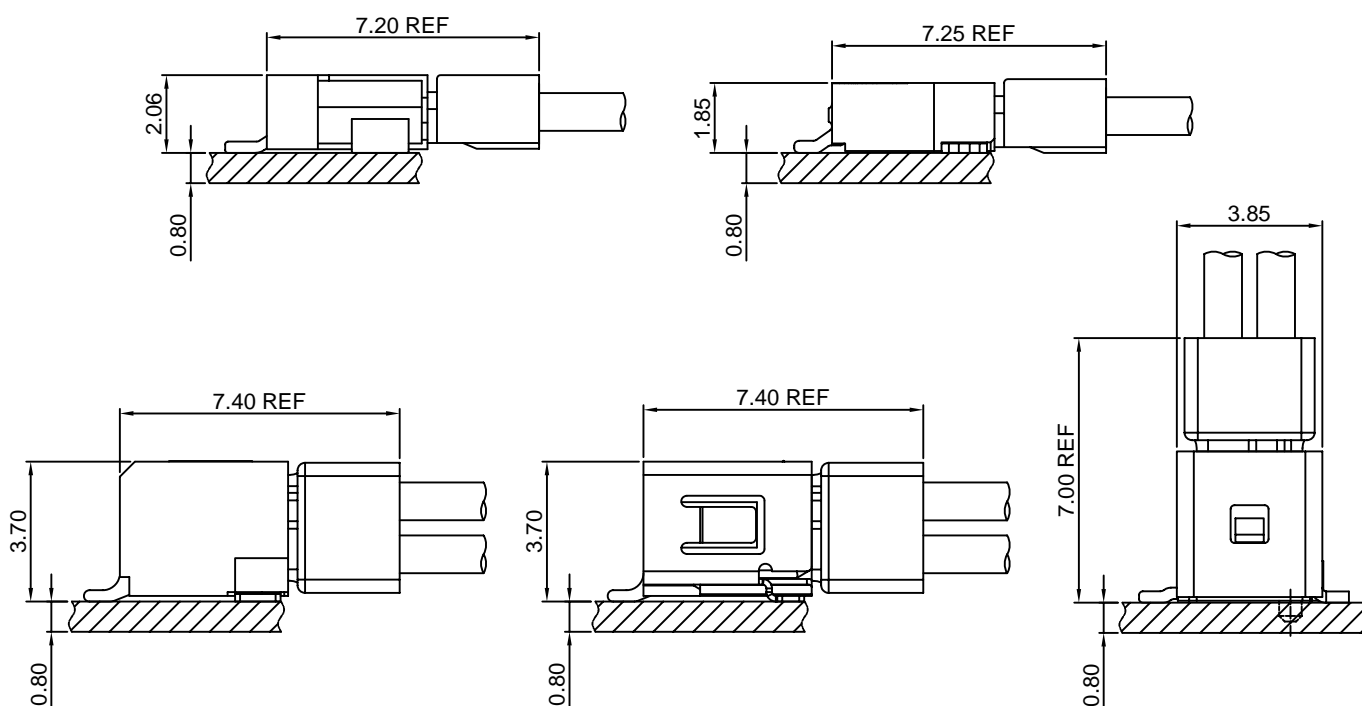

A1256-T

1.25mm pitch Crimp Terminal

Reference Informations:

*Used in CJT A1256H,HD-XP,A1255HA-XP series Housing

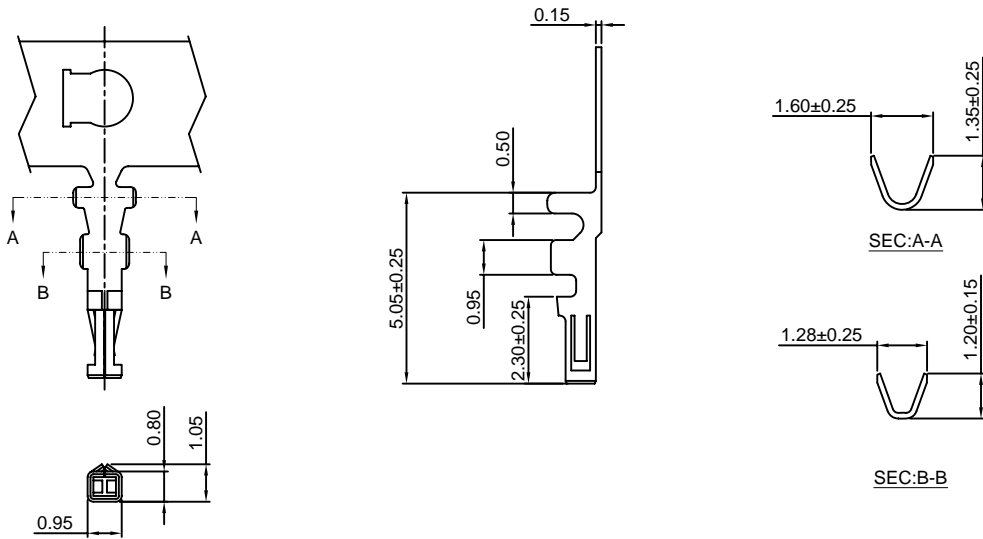

Ordering information & Specifications:

Unit:mm

| Part NO | Wire Range | Insulation O.D. | Material | Finish | Qty/reel |
|----------|------------|-----------------|-----------------|------------------|------------|
| A1256-TP | AWG#28-#32 | 0.90mm(max) | Phosphor Bronze | Tin over Nickel | 15,000 PCS |
| A1256-GP | AWG#28-#32 | 0.90mm(max) | Phosphor Bronze | Gold over Nickel | 15,000 PCS |

Optional Gold plating available but MOQ requested

A1256H-XP

1.25mm pitch Housing

Reference Informations:

- *Material:Nylon 66,UL94V-0
- *Suitable CJT A1256-T series Terminal
- *Mates with CJT A1256WR-S,WRA-S-XP series Wafer
- *Color:Black

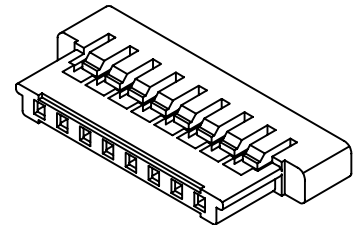

Ordering Information:

A1256H-XP - ***
1 2

- Part No.
- Material:
(Blank):Nylon 66,UL94V-0
GWT:Nylon 66,UL94V-0,GWT 750°C

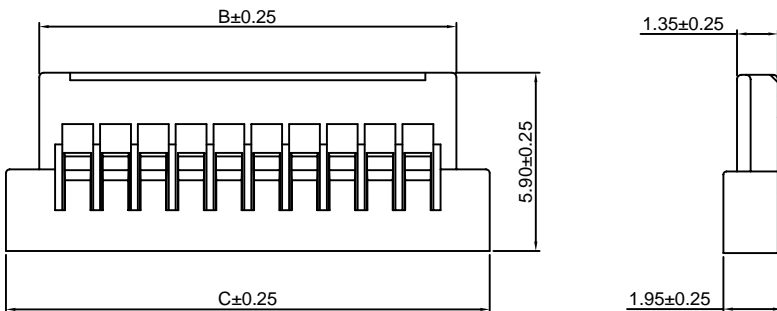
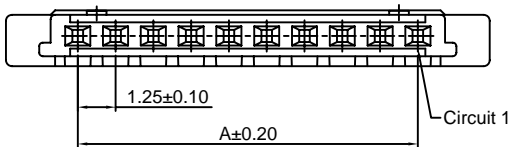

Ordering Information & Dimensions:

| PART NO. | Dimensions | | |
|----------|------------|-------|-------|
| | A | B | C |
| 2P | 1.25 | 3.80 | 6.00 |
| 3P | 2.50 | 5.05 | 7.25 |
| 4P | 3.75 | 6.30 | 8.50 |
| 5P | 5.00 | 7.55 | 9.75 |
| 6P | 6.25 | 8.80 | 11.00 |
| 8P | 8.75 | 11.30 | 13.50 |
| 10P | 11.25 | 13.80 | 16.00 |
| 15P | 17.25 | 20.05 | 22.25 |
| 20P | 23.75 | 26.30 | 28.50 |
| 25P | 30.00 | 32.55 | 34.75 |
| 30P | 36.25 | 38.80 | 41.00 |

Unit: mm

A1256HD-XP

1.25mm pitch Dual Row Housing

Reference Informations:

- *Material:Nylon 66,UL94V-0
- *Suitable CJT A1256-T series Terminal
- *Mates with CJT A1256WVD-S-F, WRD-S, WRDA-S-XP series Dual Row Wafer
- *Color:Black

Ordering Information:

- A1256HD-XP - ***
 1 2
- 1.Part No.
 2.Material:
 (Blank):Nylon 66,UL94V-0
 GWT:Nylon 66,UL94V-0,GWT 750 °C

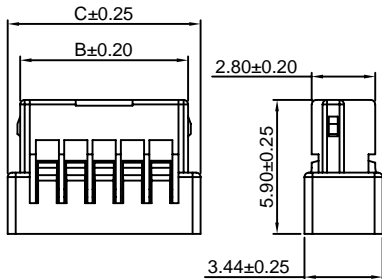
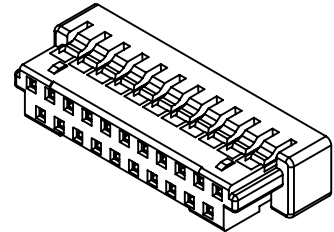
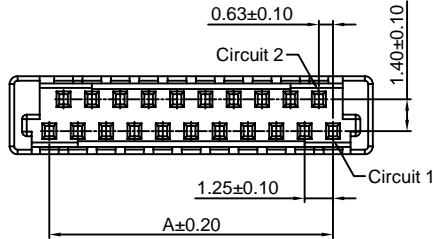
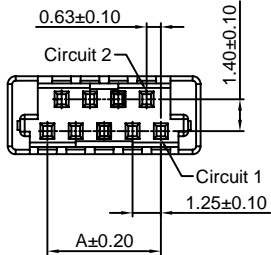

5,7,9,11 Contacts

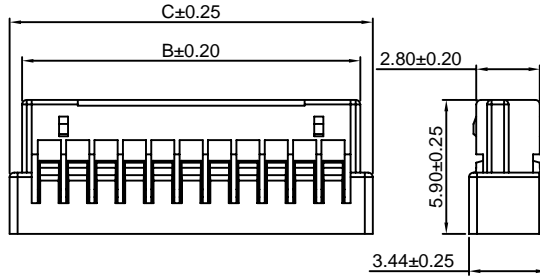

13,15,17,19,21,31,41 Contacts

Ordering Information & Dimensions:

| PART NO. | Dimensions | | |
|----------|------------|-------|-------|
| | A | B | C |
| 5P | 2.50 | 4.90 | 6.00 |
| 7P | 3.75 | 6.15 | 7.25 |
| 9P | 5.00 | 7.40 | 8.50 |
| 11P | 6.25 | 8.65 | 9.75 |
| 13P | 7.50 | 9.90 | 11.00 |
| 15P | 8.75 | 11.15 | 12.25 |
| 17P | 10.00 | 12.40 | 13.50 |
| 19P | 11.25 | 13.65 | 14.75 |
| 21P | 12.50 | 14.90 | 16.00 |
| 31P | 18.75 | 21.15 | 22.25 |
| 41P | 25.00 | 27.60 | 28.50 |

Unit: mm

A1256WR-S-XP

1.25mm pitch 90° Wafer-SMT TYPE

Reference Informations:

- *Material:Pin:Brass/Gold over Nickel
Solder Tabs:Brass/Tin over Nickel
Insulator:Nylon 6T,UL94V-0
- *Mates with CJT A1256H-XP series Housing
- *Color:White

Ordering Information:

- A1256WR-S-XP - ***
 1 2
- 1.Part No.
 2.Material:
 (Blank):Nylon 6T,UL94V-0
 GWT:Nylon 6T,UL94V-0,GWT 750 °C

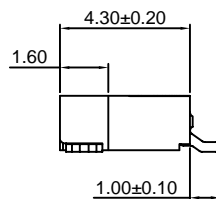
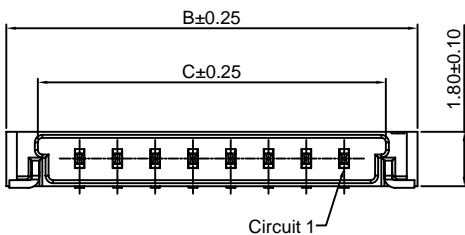
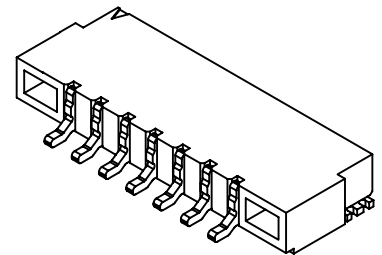
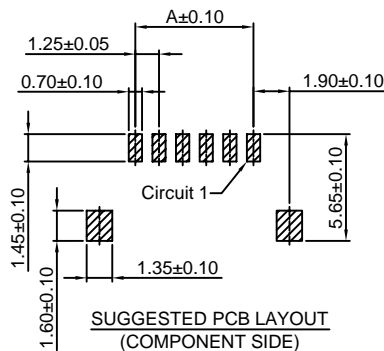
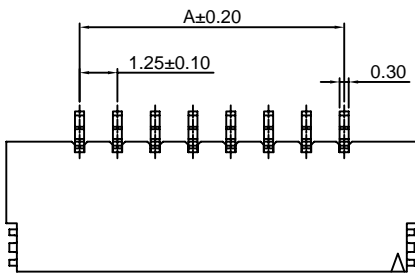

Ordering Information & Dimensions:

| PART NO. | Dimensions | | |
|----------|------------|-------|-------|
| | A | B | C |
| 2P | 1.25 | 6.10 | 4.01 |
| 3P | 2.50 | 7.35 | 5.26 |
| 4P | 3.75 | 8.60 | 6.51 |
| 5P | 5.00 | 9.85 | 7.76 |
| 6P | 6.25 | 11.10 | 9.01 |
| 8P | 8.75 | 13.60 | 11.51 |
| 10P | 11.25 | 16.10 | 14.01 |
| 15P | 17.25 | 22.35 | 20.26 |
| 20P | 23.75 | 28.60 | 26.51 |
| 25P | 30.00 | 34.85 | 32.76 |
| 30P | 36.25 | 41.10 | 39.01 |

Unit: mm

A1256WRD-S-XP

1.25mm Pitch 90° Dual Row Wafer-SMT TYPE

Reference Informations:

- *Material: Pin: Brass/Gold over Nickel
Shell: Brass/Tin over Nickel
Insulator: Nylon 6T, UL94V-0
- *Mates with CJT A1256HD-XP series Dual Row Housing
- *Color: White

Ordering Information:
A1256WRD-S-XP - ***
 1 2
 1. Part No.
 2. Material:
 (Blank): Nylon 6T, UL94V-0
 GWT: Nylon 6T, UL94V-0, GWT 750 °C

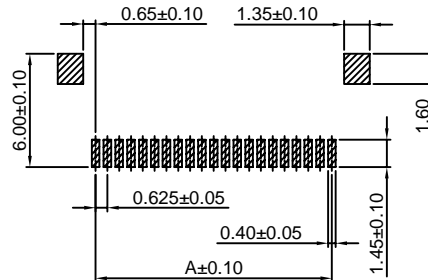
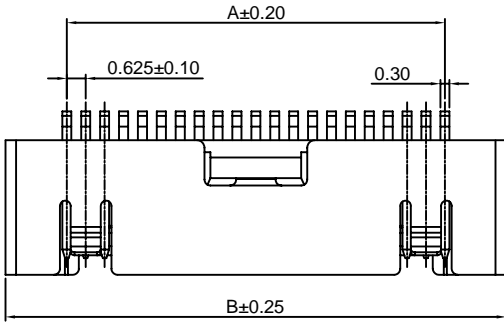
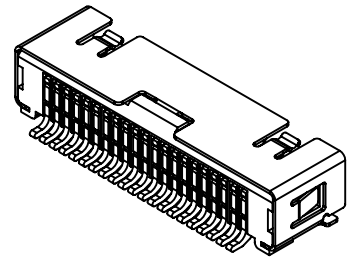

SUGGESTED PCB LAYOUT
(COMPONENT SIDE)

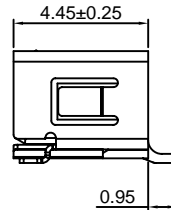
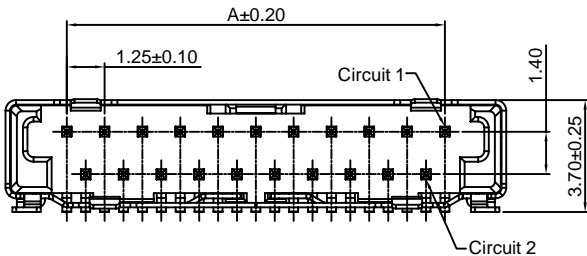

Ordering Information & Dimensions:

| PART NO. | Dimensions | |
|----------|------------|-------|
| | A | B |
| 21P | 12.50 | 16.55 |
| 31P | 18.75 | 22.80 |
| 41P | 25.00 | 29.05 |

Unit: mm

A1256WRDA-S-XP

1.25mm pitch 90° Dual Row Wafer-SMT TYPE

Reference Informations:

- *Material: Pin: Brass/Gold over Nickel
Solder Tabs: Brass/Tin over Nickel
Insulator: Nylon 6T, UL94V-0
- *Mates with CJT A1256HD-XP series dual row Housing
- *Color: White

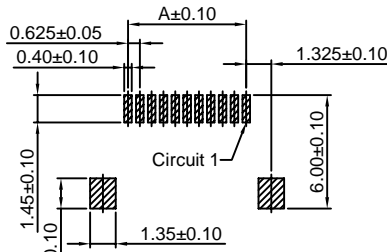

Ordering Information:
A1256WRDA-S-XP - ***
 1 2
 1. Part No.
 2. Material:
 (Blank): Nylon 6T, UL94V-0
 GWT: Nylon 6T, UL94V-0, GWT 750 °C

SUGGESTED PCB LAYOUT
(COMPONENT SIDE)

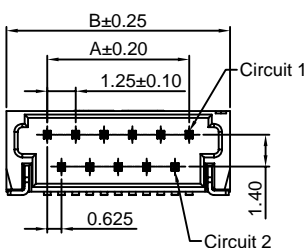
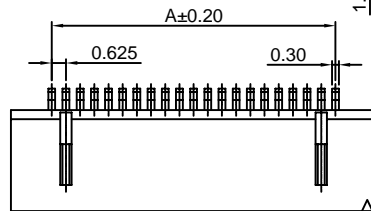
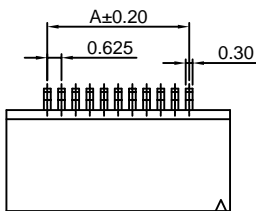

5,7,9,11 Contacts

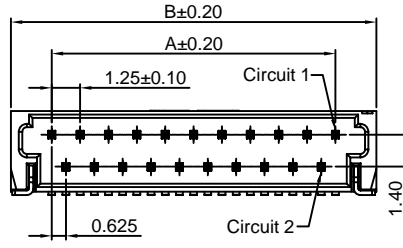

13,15,17,19,21,31,41 Contacts

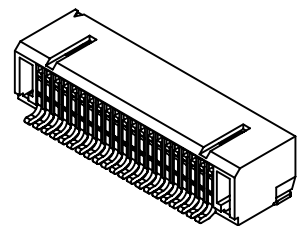
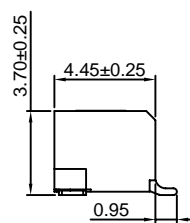

Ordering Information & Dimensions:

| PART NO. | Dimensions | |
|----------|------------|-------|
| | A | B |
| 5P | 2.50 | 6.10 |
| 7P | 3.75 | 7.35 |
| 9P | 5.00 | 8.60 |
| 11P | 6.25 | 9.85 |
| 13P | 7.50 | 11.10 |
| 15P | 8.75 | 12.35 |
| 17P | 10.00 | 13.60 |
| 19P | 11.25 | 14.85 |
| 21P | 12.50 | 16.10 |
| 31P | 18.75 | 22.35 |
| 41P | 25.00 | 28.60 |

Unit: mm

X-ON Electronics

Largest Supplier of Electrical and Electronic Components

Click to view similar products for [Headers & Wire Housings](#) category:

Click to view products by [Changjiang](#) manufacturer:

Other Similar products are found below :

[95000-104TRLF](#) [10135584-644402LF](#) [DF62W-EP2022PCA](#) [95000-106TRLF](#) [DF62W-2022SCA](#) [DF62W-EP2022PC](#) [2203348](#) [DF62W-2022SC](#) [1084018](#) [1029039](#) [1084017](#) [802-10-012-10-002000](#) [1112640](#) [1112639](#) [891-007-9SS-BST1T](#) [000-34000](#) [0008550134](#) [0009482033](#) [0009507031](#) [57102-F02-18ULF](#) [57102-S06-03LF](#) [57202-S52-04LF](#) [PCN6-15S-2.5E](#) [0039019024](#) [58102-G61-06LF](#) [582553-1](#) [0009485154](#) [0009508121](#) [0022285053](#) [0050291907](#) [018731A](#) [LY20-4P-DT1-P1E-BR](#) [02.125.8002.8](#) [60101931](#) [60598-1 \(Cut Strip\)](#) [M1625-3R/100](#) [61062-3](#) [61082-181009](#) [CSU011177004](#) [636-1427](#) [638009-1](#) [641938-9](#) [641991-4](#) [644168-1](#) [644827-2](#) [647662-1](#) [65039-019ELF](#) [65692-001LF](#) [65781-018](#) [65781-047](#)