

Specifications

- Current rating:7A AC,DC
- Voltage rating:250V AC,DC
- Temperature range:-40°C~+105°C
- Contact resistance:10mΩMax.
- Insulation resistance:1000MΩMin.
- Withstanding voltage:1500V AC/minute
- *Compliant with RoHS and REACH*
- *Meet the HF/Halogen Free,GWT/Glow wire Test (IEC60335-1) request,need to customize*
- *Contact CJT for details*

Standards



Assembly layout

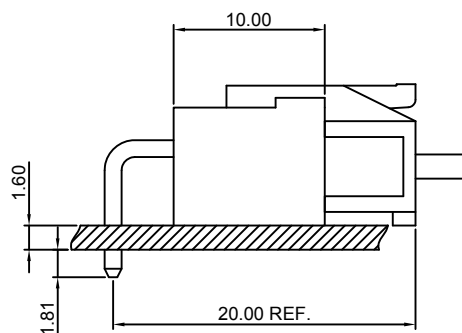
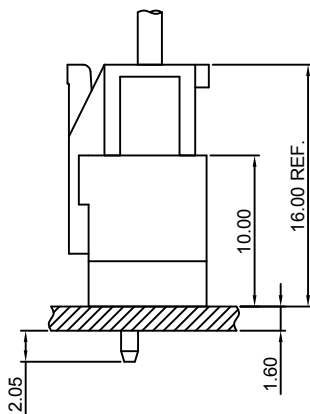

A3965-T

3.96mm pitch Crimp Terminal

Reference Informations:

*Used in CJT A3965H-XP, A3965HA-XP-GWT, A3502H-XP series Housing

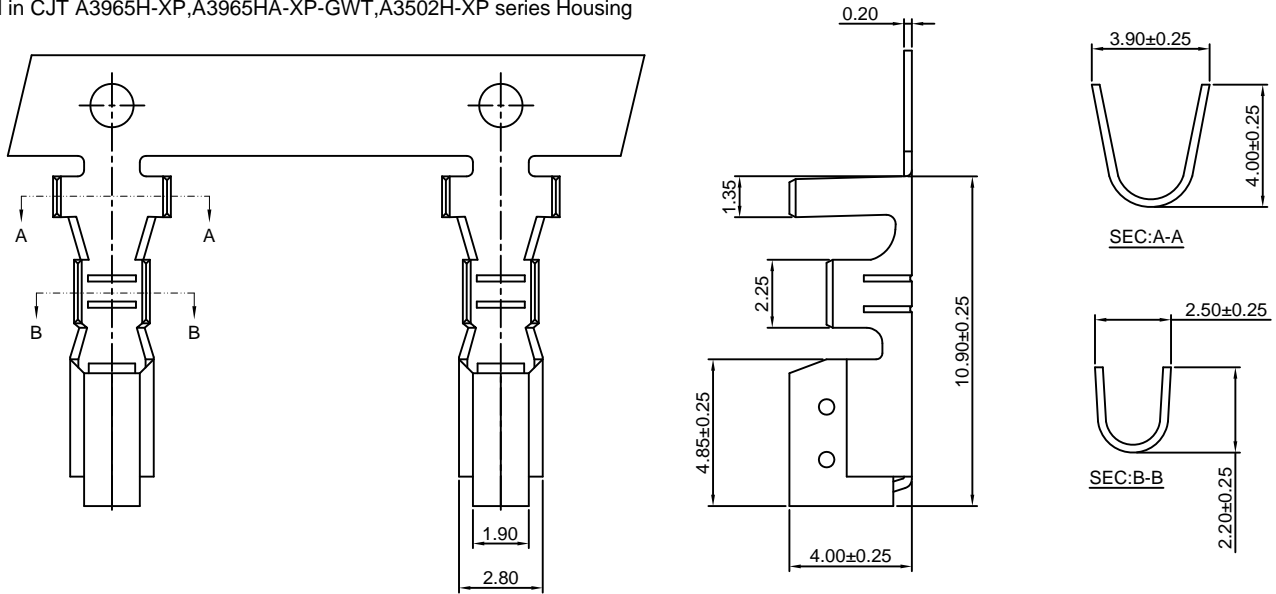

Ordering information & Specifications:

Unit:mm

Part NO.	Wire Range	Insulation O.D.	Material	Finish	Qty/reel
A3965-TB	AWG#18-#24	3.20mm(max)	Brass	Tin over Nickel	3,000 PCS
A3965-TP	AWG#18-#24	3.20mm(max)	Phosphor Bronze	Tin over Nickel	3,000 PCS
A3965-GB	AWG#18-#24	3.20mm(max)	Brass	Gold over Nickel	3,000 PCS
A3965-GP	AWG#18-#24	3.20mm(max)	Phosphor Bronze	Gold over Nickel	3,000 PCS

Optional Gold plating available but MOQ requested

A3965H-XP

3.96mm pitch Housing

Reference Informations:

*Material:Nylon 66,UL94V-0

*Suitable CJT A3965-T series Terminal

*Mates with CJT A3965HM-XP series Housing and

A3965WV, WR-XP(-A), A3965WV-F-XP(-A)-GWT series Wafer

*Color:White

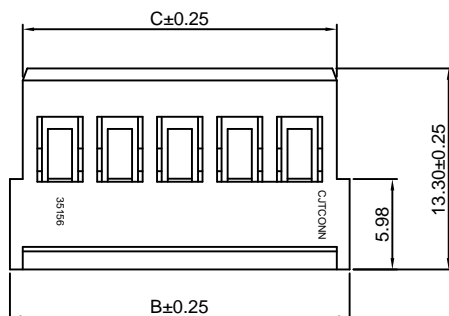
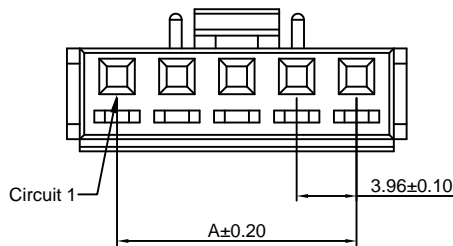

Ordering Information:

A3965H-XP - ***
1 2

1.Part No.

2.Material:

(blank):Nylon 66,UL94V-0

GWT:Nylon 66,UL94V-0,GWT 750°C

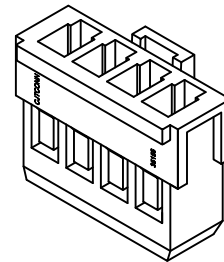

Ordering Information & Dimensions:

PART NO.	Dimensions		
	A	B	C
2P	3.96	10.58	8.88
3P	7.92	14.54	12.84
4P	11.88	18.50	16.80
5P	15.84	22.46	20.76
6P	19.80	26.42	24.72
7P	23.76	30.38	28.68
8P	27.72	34.34	32.64
9P	31.68	38.30	36.60
10P	35.64	42.26	40.56
11P	39.60	46.22	44.52
12P	43.56	50.18	48.48
13P	47.52	54.14	52.44
14P	51.48	58.10	56.40
15P	55.44	62.06	60.36

Unit: mm

A3965HA-XP-GWT

3.96mm pitch Housing

Reference Informations:

- *Material: Nylon 66, UL94V-0, GWT 750°C
- *Suitable CJT A3965-T series Terminal
- *Mates with CJT A3965HM-XP series Housing and A3965WV, WR-XP(-A), A3965WV-F-XP(-A)-GWT series Wafer and A3965S-XP-GWT series Retainer
- *Color: Ivory

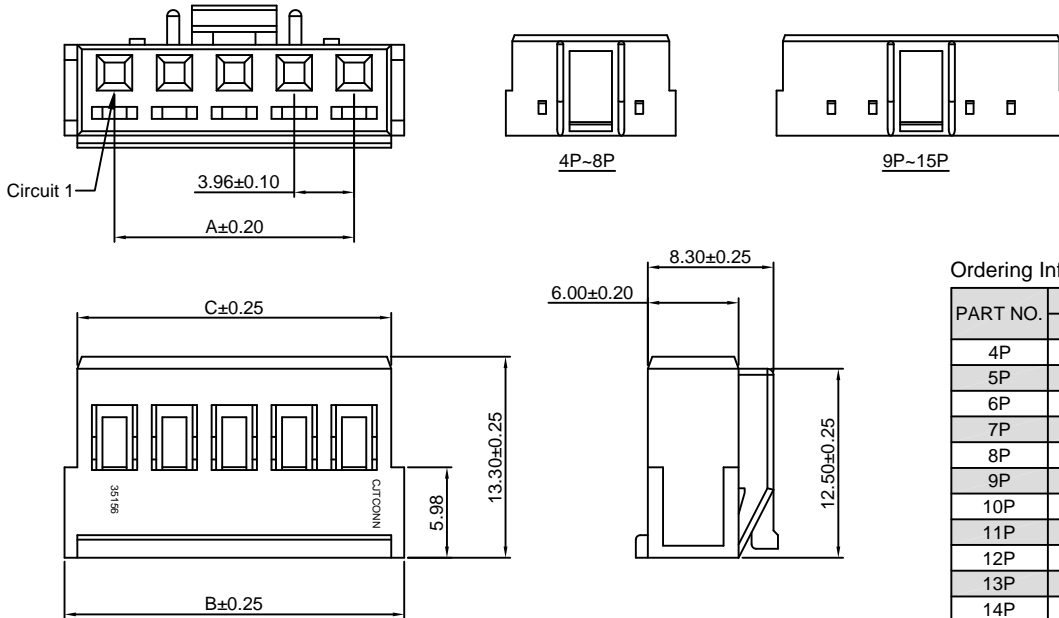

Ordering Information & Dimensions:

PART NO.	Dimensions		
	A	B	C
4P	11.88	18.50	16.80
5P	15.84	22.46	20.76
6P	19.80	26.42	24.72
7P	23.76	30.38	28.68
8P	27.72	34.34	32.64
9P	31.68	38.30	36.60
10P	35.64	42.26	40.56
11P	39.60	46.22	44.52
12P	43.56	50.18	48.48
13P	47.52	54.14	52.44
14P	51.48	58.10	56.40
15P	55.44	62.06	60.36

Unit: mm

A3965S-XP-GWT

3.96mm pitch Retainer

Reference Informations:

- *Material: Nylon 66, UL94V-0, GWT 750°C
- *Used in CJT A3965HA-XP-GWT series Housing
- *Color: Brick Red

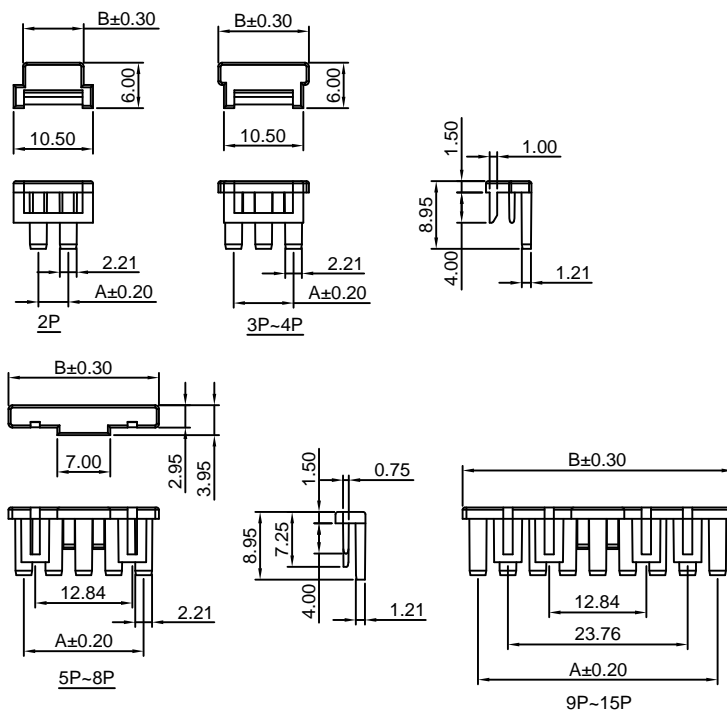

Ordering Information & Dimensions:

PART NO.	Dimensions	
	A	B
2P	3.96	8.02
3P	7.92	11.98
4P	11.88	15.94
5P	15.84	19.90
6P	19.80	23.86
7P	23.76	27.82
8P	27.72	31.78
9P	31.68	35.74
10P	35.64	39.70
11P	39.60	43.66
12P	43.56	47.62
13P	47.52	51.58
14P	51.48	55.54
15P	55.44	59.50

Unit: mm

A3965HM-XP-GWT

3.96mm pitch Housing

Reference Informations:

- *Material:Nylon 66,UL94V-0,GWT 750°C
- *Suitable CJT A3965M-T series Terminal
- *Mates with CJT A3965H-XP,A3965HA-XP-GWT series Housing
- *Color:White

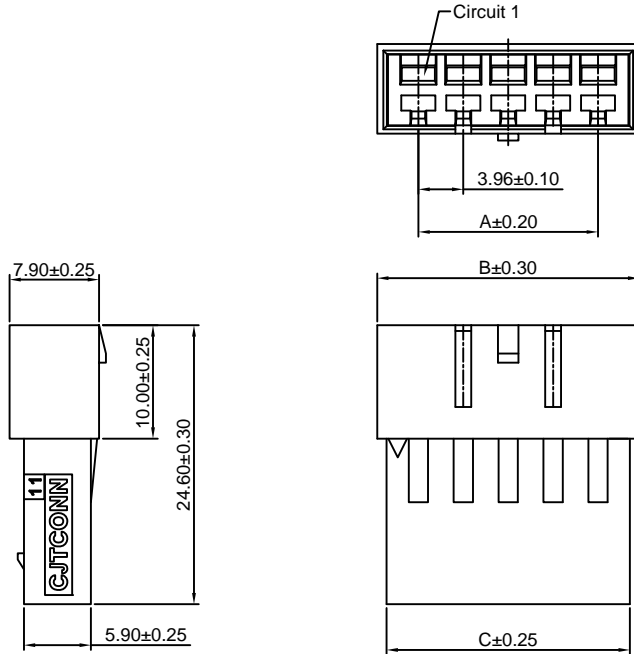

Ordering Information & Dimensions:

PART NO.	Dimensions		
	A	B	C
2P	3.96	11.22	9.65
3P	7.92	15.18	13.52
4P	11.88	19.14	17.39
5P	15.84	23.10	21.26
6P	19.80	27.06	25.13
7P	23.76	31.02	29.00
8P	27.72	34.98	32.87
9P	31.68	38.94	36.74
10P	35.64	42.90	40.61
11P	39.60	46.86	44.48
12P	43.56	50.82	48.35
13P	47.52	54.78	52.22
14P	51.48	58.74	56.09
15P	55.44	62.70	59.96

Unit: mm

A3965WV(-F)-XP

3.96mm pitch 180° Wafer

Reference Informations:

- *Material:Pin:Brass/Tin over Nickel
Insulator:Nylon 66,UL94V-0,Nylon 66,UL94V-0 GWT 750°C
- *Mates with CJT A3965H-XP,A3965HA-XP-GWT series Housing
- *Color:Ivory

Ordering Information:

- A3965WV(-F)-XP - **
- 1 2
- 1.Part No.
 - 2.Material:
(blank):Nylon 66,UL94V-0 (A3965WV-XP)
GWT:Nylon 66,UL94V-0,GWT 750°C (A3965WV(-F)-XP)
 - 3.Finish:
(blank):Tin over Nickel
G:Gold over Nickel

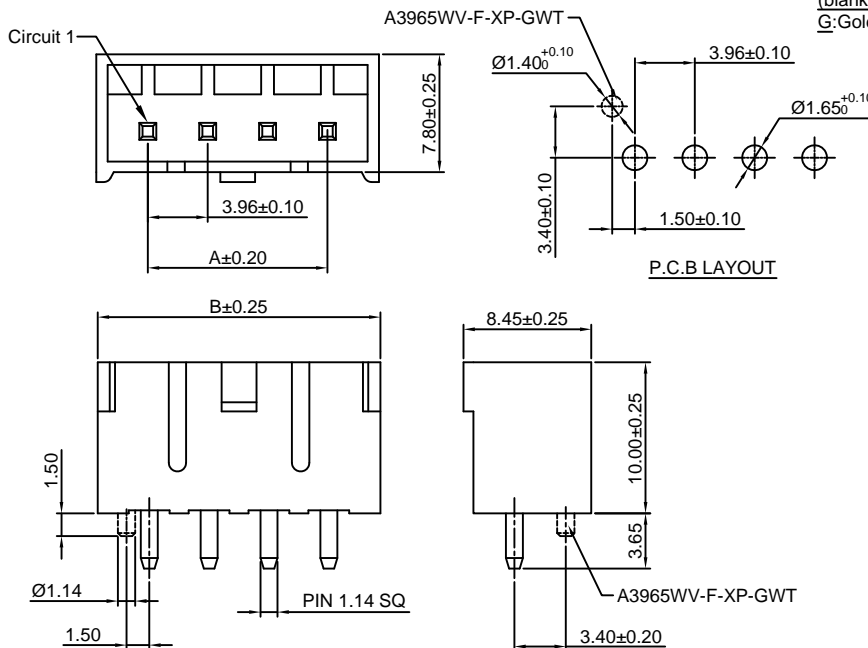

Ordering Information & Dimensions:

PART NO.	Dimensions	
	A	B
2P	3.96	10.58
3P	7.92	14.54
4P	11.88	18.50
5P	15.84	22.46
6P	19.80	26.42
7P	23.76	30.38
8P	27.72	34.34
9P	31.68	38.30
10P	35.64	42.26
11P	39.60	46.22
12P	43.56	50.18
13P	47.52	54.14
14P	51.48	58.10
15P	55.44	62.06

Unit: mm

A3965WR-XP

3.96mm pitch 90° Wafer

Reference Informations:

- *Material:Pin:Brass/Tin over Nickel
Insulator:Nylon 66,UL94V-0
- *Mates with CJT A3965H-XP,A3965HA-XP-GWT series Housing
- *Color:White

Ordering Information:
A3965WR-XP - *** - **
1 2 3

- 1.Part No.
- 2.Material:
(blank):Nylon 66,UL94V-0
GWT:Nylon 66,UL94V-0,GWT 750°C
- 3.Finish:
(blank):Tin over Nickel
G:Gold over Nickel

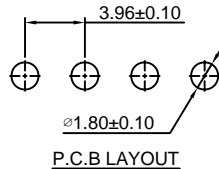
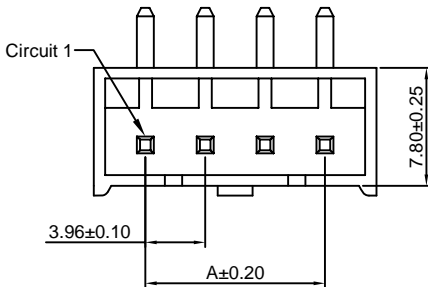
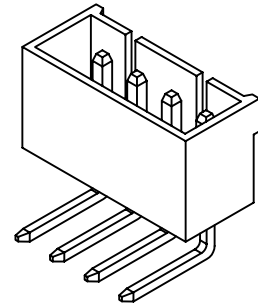

Ordering Information & Dimensions:

PART NO.	Dimensions	
	A	B
2P	3.96	10.58
3P	7.92	14.54
4P	11.88	18.50
5P	15.84	22.46
6P	19.80	26.42
7P	23.76	30.38
8P	27.72	34.34
9P	31.68	38.30
10P	35.64	42.26
11P	39.60	46.22
12P	43.56	50.18
13P	47.52	54.14
14P	51.48	58.10
15P	55.44	62.06

Unit: mm

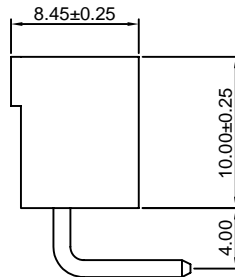
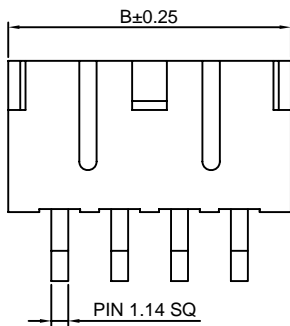

A3965WV-XP-A

7.92mm pitch 180° Wafer

Reference Informations:

- *Material:Pin:Brass/Tin over Nickel
Insulator:Nylon 66, UL94V-0
- *Mates with CJT A3965H-XP,A3965HA-XP-GWT series Housing
- *Color:White

Ordering Information:
A3965WV-XP-A - *** - **
1 2 3

- 1.Part No.
- 2.Material:
(blank):Nylon 66,UL94V-0
GWT:Nylon 66,UL94V-0,GWT 750°C
- 3.Finish:
(blank):Tin over Nickel
G:Gold over Nickel

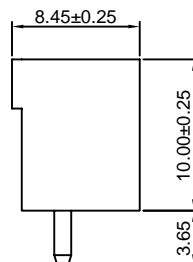
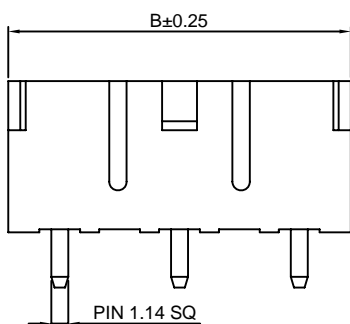
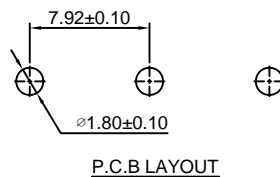
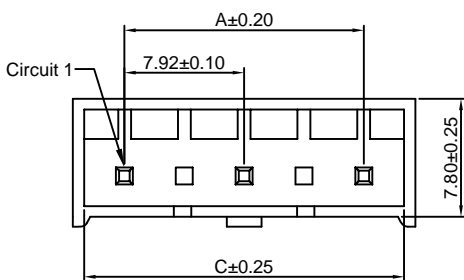
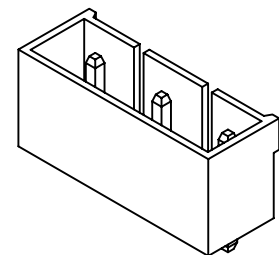

Ordering Information & Dimensions:

PART NO.	Dimensions		
	A	B	C
3P	7.92	14.74	13.14
5P	15.84	22.66	21.06
7P	23.76	30.58	28.98
9P	31.68	38.50	36.90
11P	39.60	46.42	44.82
13P	47.52	54.34	52.74
15P	55.44	62.26	60.66

Unit: mm

A3965WR-XP-A

7.92mm pitch 90° Wafer

Reference Informations:

- *Material: Pin: Brass/Tin over Nickel
Insulator: Nylon 66, UL94V-0
- *Mates with CJT A3965H-XP, A3965HA-XP-GWT series Housing
- *Color: White

Ordering Information:

- A3965WR-XP-A - $\frac{***}{2}$ - $\frac{**}{3}$
1. Part No.
 2. Material:
(blank): Nylon 66, UL94V-0
GWT: Nylon 66, UL94V-0, GWT 750°C
 3. Finish:
(blank): Tin over Nickel
G: Gold over Nickel

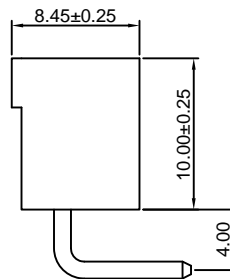
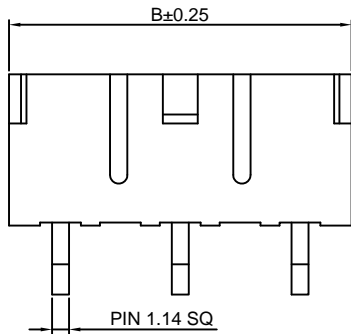
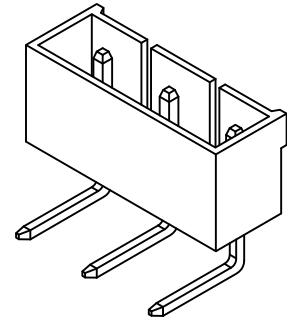
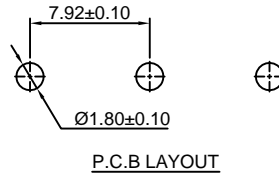
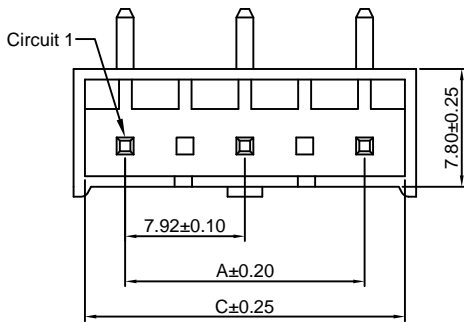

Ordering Information & Dimensions:

PART NO.	Dimensions		
	A	B	C
3P	7.92	14.74	13.14
5P	15.84	22.66	21.06
7P	23.76	30.58	28.98
9P	31.68	38.50	36.90
11P	39.60	46.42	44.82
13P	47.52	54.34	52.74
15P	55.44	62.26	60.66

Unit: mm

A3965WV-F-XP-A-GWT

3.96mm pitch 180° Wafer

Reference Informations:

- *Material: Pin: Brass/Tin over Nickel
Insulator: Nylon 66, UL94V-0, GWT 750°C
- *Mates with CJT A3965H-XP, A3965HA-XP-GWT series Housing
- *Color: Ivory

Ordering Information:

- A3965WV-F-XP-A-GWT - $\frac{**}{2}$
1. Part No.
 2. Finish:
(blank): Tin over Nickel
G: Gold over Nickel

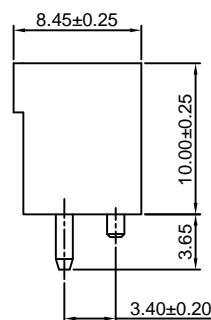
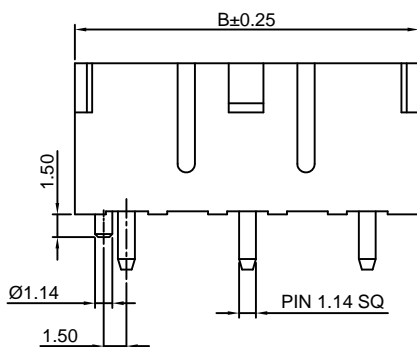
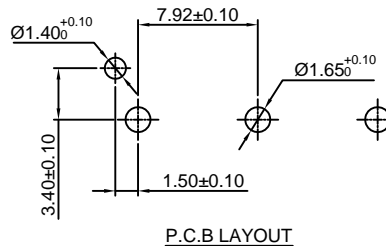
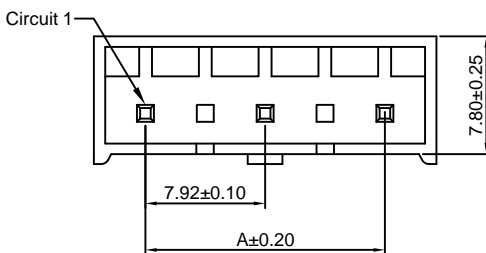

Ordering Information & Dimensions:

PART NO.	Dimensions	
	A	B
3P	7.92	14.54
5P	15.84	22.46
7P	23.76	30.38
9P	31.68	38.30
11P	39.60	46.22
13P	47.52	54.14
15P	55.44	62.06

Unit: mm

X-ON Electronics

Largest Supplier of Electrical and Electronic Components

Click to view similar products for [Headers & Wire Housings](#) category:

Click to view products by [Changjiang](#) manufacturer:

Other Similar products are found below :

[95000-104TRLF](#) [10135584-644402LF](#) [DF62W-EP2022PCA](#) [95000-106TRLF](#) [DF62W-2022SCA](#) [DF62W-EP2022PC](#) [2203348](#) [DF62W-2022SC](#) [1084018](#) [1029039](#) [1084017](#) [802-10-012-10-002000](#) [1112640](#) [1112639](#) [891-007-9SS-BST1T](#) [000-34000](#) [0008550134](#) [0009482033](#) [0009507031](#) [57102-F02-18ULF](#) [57102-S06-03LF](#) [57202-S52-04LF](#) [PCN6-15S-2.5E](#) [0039019024](#) [58102-G61-06LF](#) [582553-1](#) [0009485154](#) [0009508121](#) [0022285053](#) [0050291907](#) [018731A](#) [LY20-4P-DT1-P1E-BR](#) [02.125.8002.8](#) [60101931](#) [60598-1 \(Cut Strip\)](#) [M1625-3R/100](#) [61062-3](#) [61082-181009](#) [CSU011177004](#) [636-1427](#) [638009-1](#) [641938-9](#) [641991-4](#) [644168-1](#) [644827-2](#) [647662-1](#) [65039-019ELF](#) [65692-001LF](#) [65781-018](#) [65781-047](#)