

Specifications

- Current rating: 5.5A AC, DC (Max)
- Voltage rating: 250V AC, DC
- Temperature range: -40°C ~ +105°C
- Contact resistance: 10mΩ Max.
- Insulation resistance: 1000MΩ Min.
- Withstanding voltage: 1500V AC/minute
- *Compliant with RoHS and REACH*
- *Meet the HF/Halogen Free, GWT/Glow wire Test (IEC60335-1) request, need to customize*
- *Contact CJT for details*

Standards



Assembly layout

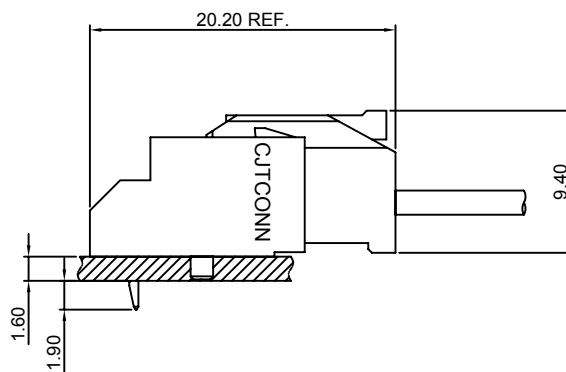
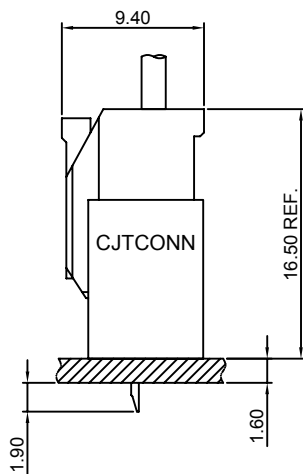

A3502H-XP

3.50mm Pitch Housing

Reference Informations:

- *Material:Nylon 66,UL94V-0
- *Suitable CJT A3965-T series Terminal
- *Mates with CJT A3502WV,WR-XP(-A) series Wafer
- *Color:White

Ordering Information:

A3502H-XP - *** - **
 1 2 3

- 1.Part No.
- 2.Material:
 (blank):Nylon 66,UL94V-0
 PBT:PBT,UL94V-0
 GWT:Nylon 66,UL94V-0,GWT 750°C
- 3.Color:
 (blank):White
 BK:Black
 RD:Red
 YL:Yellow
 BL:Blue
 GN:Green

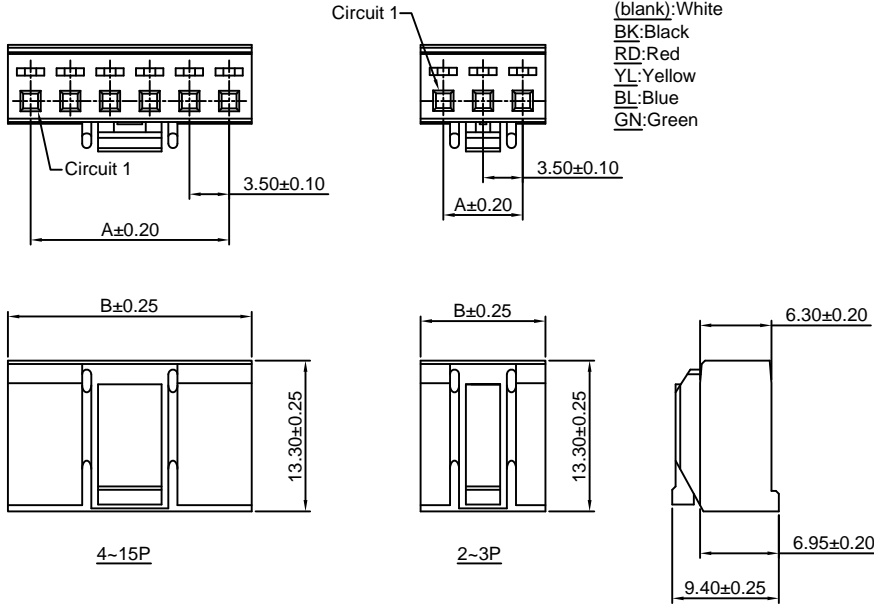
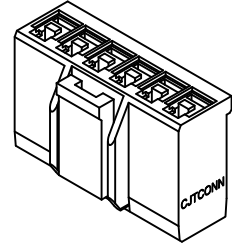

Ordering Information & Dimensions:

PART NO.	Dimensions	
	A	B
2P	3.50	7.50
3P	7.00	11.00
4P	10.50	14.50
5P	14.00	18.00
6P	17.50	21.50
7P	21.00	25.00
8P	24.50	28.50
9P	28.00	32.00
10P	31.50	35.50
11P	35.00	39.00
12P	38.50	42.50
13P	42.00	46.00
14P	45.50	49.50
15P	49.00	53.00

Unit: mm

A3502WV-XP

3.50mm Pitch 180° WAFER

Reference Informations:

- *Material:Pin:Brass/Tin over Nickel
 Insulator:PBT+15%GF,UL94V-0
- *Mates with CJT A3502H-XP series Housing
- *Color:White

Ordering Information:

A3502WV-XP - *** - ** - **
 1 2 3 4

- 1.Part No.
- 2.Material:
 (blank):PBT+15%GF,UL94V-0
 GWT:PBT,UL94V-0,GWT 750°C
- 3.Color:
 (blank):White
 BK:Black
 RD:Red
 YL:Yellow
 BL:Blue
 GN:Green
 PK:Pink
- 4.Finish:
 (blank):Tin over Nickel
 G:Gold over Nickel

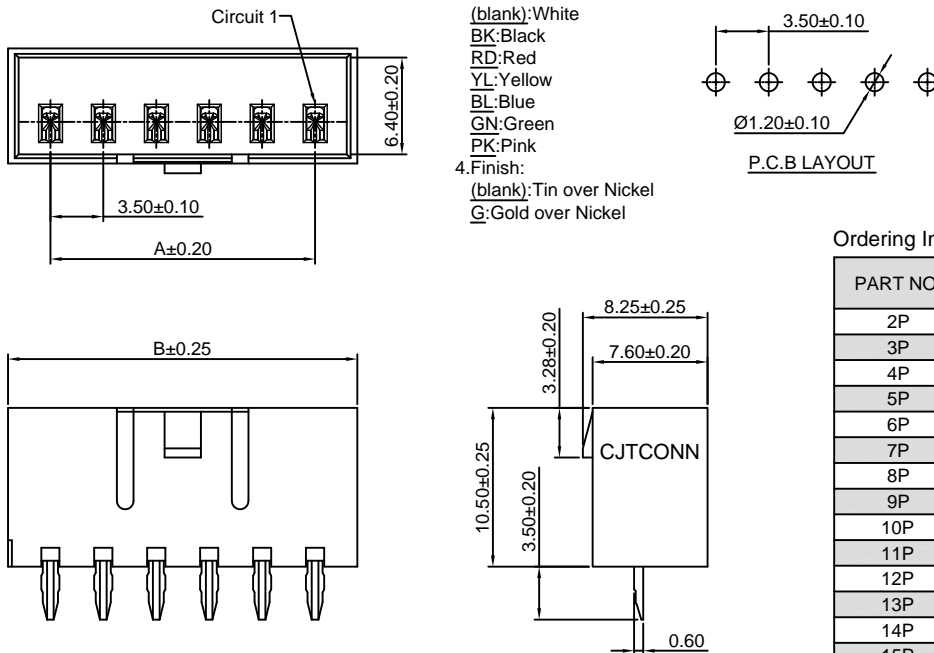
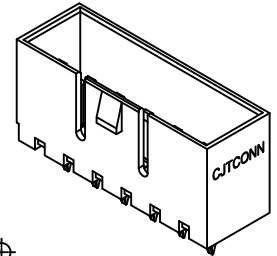

Ordering Information & Dimensions:

PART NO.	Dimensions	
	A	B
2P	3.50	9.10
3P	7.00	12.60
4P	10.50	16.10
5P	14.00	19.60
6P	17.50	23.10
7P	21.00	26.60
8P	24.50	30.10
9P	28.00	33.60
10P	31.50	37.10
11P	35.00	40.60
12P	38.50	44.10
13P	42.00	47.60
14P	45.50	51.10
15P	49.00	54.60

Unit: mm

A3502WV-XP-A

7.00mm Pitch 180° WAFER

Reference Informations:

- *Material:Pin:Brass/Tin over Nickel
Insulator:PBT+15%GF,UL94V-0
- *Mates with CJT A3502H-XP series Housing
- *Color:White

Ordering Information:

A3502WV-XP-A - *** - ** - **
1 2 3 4

- 1.Part No.
- 2.Material:
(blank):PBT+15%GF,UL94V-0
GWT:PBT,UL94V-0,GWT 750°C
- 3.Color:
(blank):White
BK:Black
RD:Red
YL:Yellow
BL:Blue
GN:Green
PK:Pink
- 4.Finish:
(blank):Tin over Nickel
G:Gold over Nickel

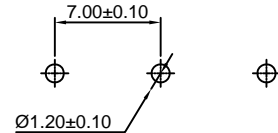
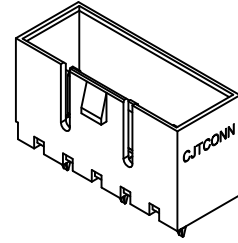
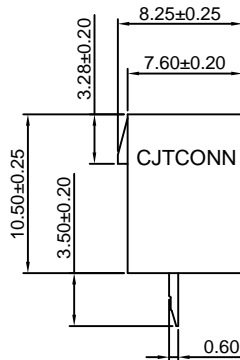
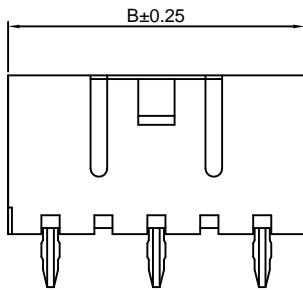
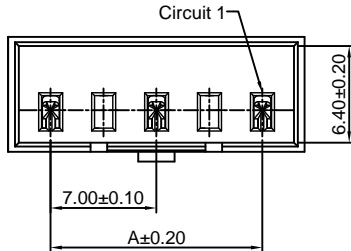

P.C.B LAYOUT

Ordering Information & Dimensions:

PART NO.	Dimensions	
	A	B
3P	7.00	12.60
5P	14.00	19.60
7P	21.00	26.60
9P	28.00	33.60
11P	35.00	40.60
13P	42.00	47.60
15P	49.00	54.60

Unit: mm

A3502WR-XP

3.50mm Pitch 90° WAFER

Reference Informations:

- *Material:Pin:Brass/Tin over Nickel
Insulator:PBT+15%GF,UL94V-0
- *Mates with CJT A3502H-XP series Housing
- *Color:White

Ordering Information:

A3502WR-XP - *** - ** - **
1 2 3 4

- 1.Part No.
- 2.Material:
(blank):PBT+15%GF,UL94V-0
GWT:PBT,UL94V-0,GWT 750°C
- 3.Color:
(blank):White
BK:Black
RD:Red
YL:Yellow
BL:Blue
GN:Green
PK:Pink
- 4.Finish:
(blank):Tin over Nickel
G:Gold over Nickel

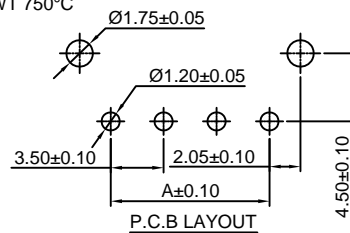
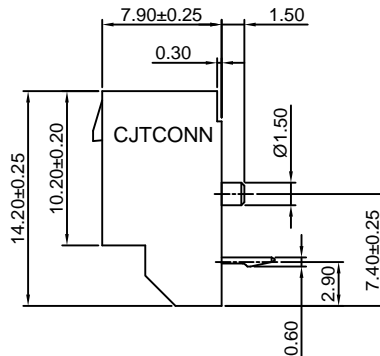
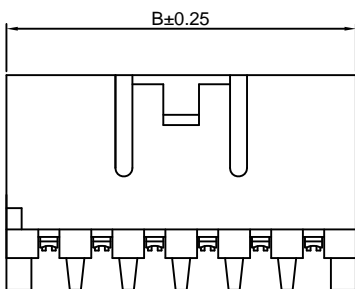
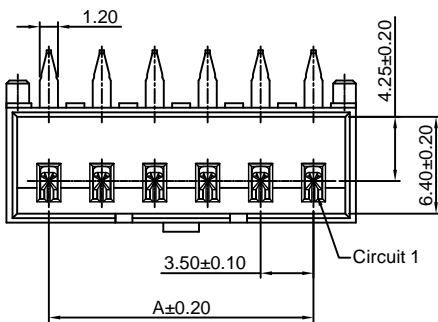

P.C.B LAYOUT

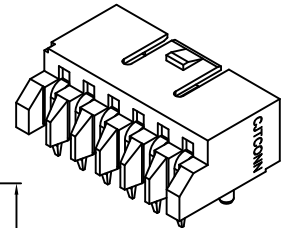

Ordering Information & Dimensions:

PART NO.	Dimensions	
	A	B
2P	3.50	9.10
3P	7.00	12.60
4P	10.50	16.10
5P	14.00	19.60
6P	17.50	23.10
7P	21.00	26.60
8P	24.50	30.10
9P	28.00	33.60
10P	31.50	37.10
11P	35.00	40.60
12P	38.50	44.10
13P	42.00	47.60
14P	45.50	51.10
15P	49.00	54.60

Unit: mm

A3502WR-XP-A

7.00mm Pitch 90° WAFER

Reference Informations:

- *Material:Pin:Brass/Tin over Nickel
Insulator:PBT+15%GF,UL94V-0
- *Mates with CJT A3502H-XP series Housing
- *Color:White

Ordering Information:

A3502WR-XP-A - *** - ** - **
1 2 3 4

- 1.Part No.
- 2.Material:
(blank):PBT+15%GF,UL94V-0
GWT:PBT,UL94V-0,GWT 750°C
- 3.Color:
(blank):White
BK:Black
RD:Red
YL:Yellow
BL:Blue
GN:Green
PK:Pink
- 4.Finish:
(blank):Tin over Nickel
G:Gold over Nickel

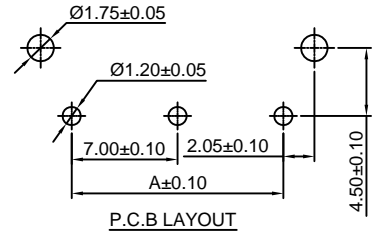
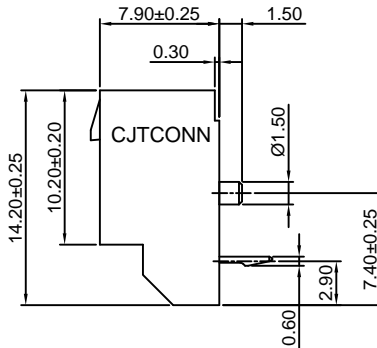
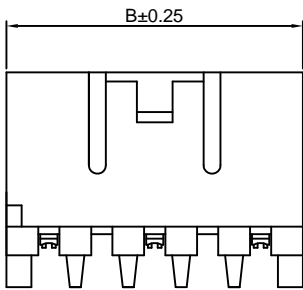
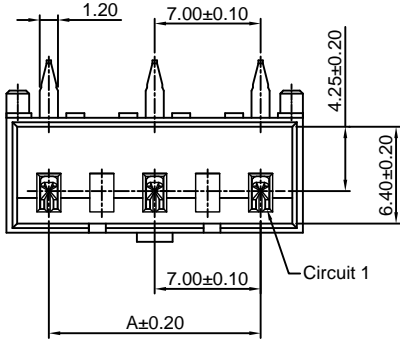
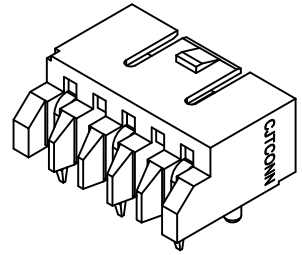

Ordering Information & Dimensions:

PART NO.	Dimensions	
	A	B
3P	7.00	12.60
5P	14.00	19.60
7P	21.00	26.60
9P	28.00	33.60
11P	35.00	40.60
13P	42.00	47.60
15P	49.00	54.60

Unit: mm

X-ON Electronics

Largest Supplier of Electrical and Electronic Components

Click to view similar products for [Headers & Wire Housings](#) category:

Click to view products by [Changjiang](#) manufacturer:

Other Similar products are found below :

[95000-104TRLF](#) [10135584-644402LF](#) [DF62W-EP2022PCA](#) [95000-106TRLF](#) [DF62W-2022SCA](#) [DF62W-EP2022PC](#) [2203348](#) [DF62W-2022SC](#) [1084018](#) [1029039](#) [1084017](#) [802-10-012-10-002000](#) [1112640](#) [1112639](#) [891-007-9SS-BST1T](#) [000-34000](#) [0008550134](#) [0009482033](#) [0009507031](#) [57102-F02-18ULF](#) [57102-S06-03LF](#) [57202-S52-04LF](#) [PCN6-15S-2.5E](#) [0039019024](#) [58102-G61-06LF](#) [582553-1](#) [0009485154](#) [0009508121](#) [0022285053](#) [0050291907](#) [018731A](#) [LY20-4P-DT1-P1E-BR](#) [02.125.8002.8](#) [60101931](#) [60598-1 \(Cut Strip\)](#) [M1625-3R/100](#) [61062-3](#) [61082-181009](#) [CSU011177004](#) [636-1427](#) [638009-1](#) [641938-9](#) [641991-4](#) [644168-1](#) [644827-2](#) [647662-1](#) [65039-019ELF](#) [65692-001LF](#) [65781-018](#) [65781-047](#)