

Specifications

- Current rating:10A AC,DC(AWG #16)
- Voltage rating:250V AC,DC
- Temperature range:-40°C~+105°C
- Contact resistance:10mΩMax.
- Insulation resistance:1000MΩMin.
- Withstanding voltage:1500V AC/minute
- *Compliant with RoHS and REACH*
- *Meet the HF/Halogen Free,GWT/Glow wire Test (IEC60335-1) request,need to customize*
- *Contact CJT for details*

Standards

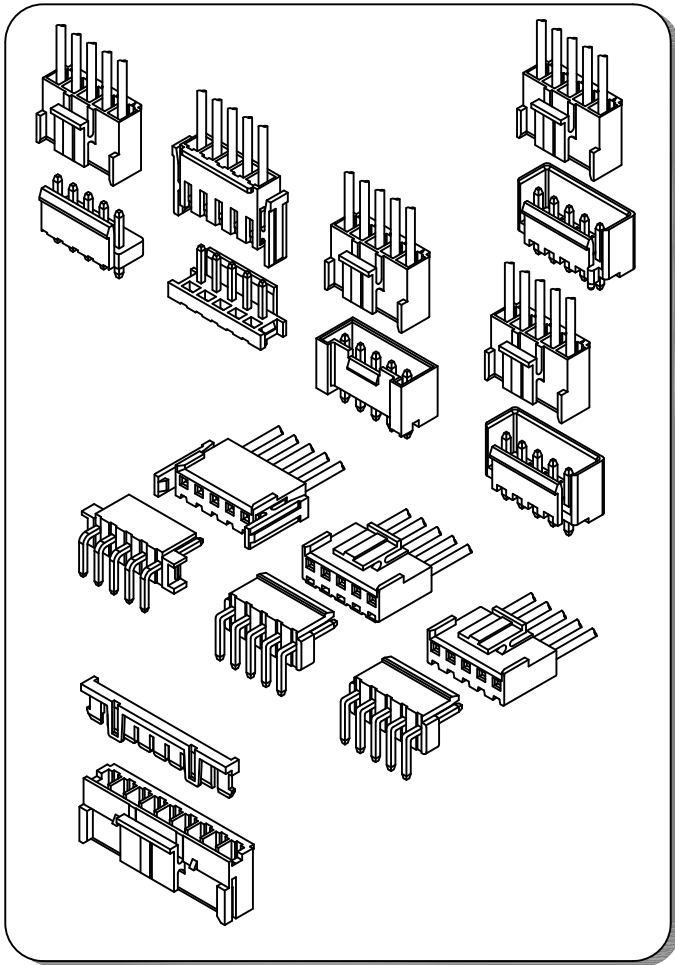

Assembly layout

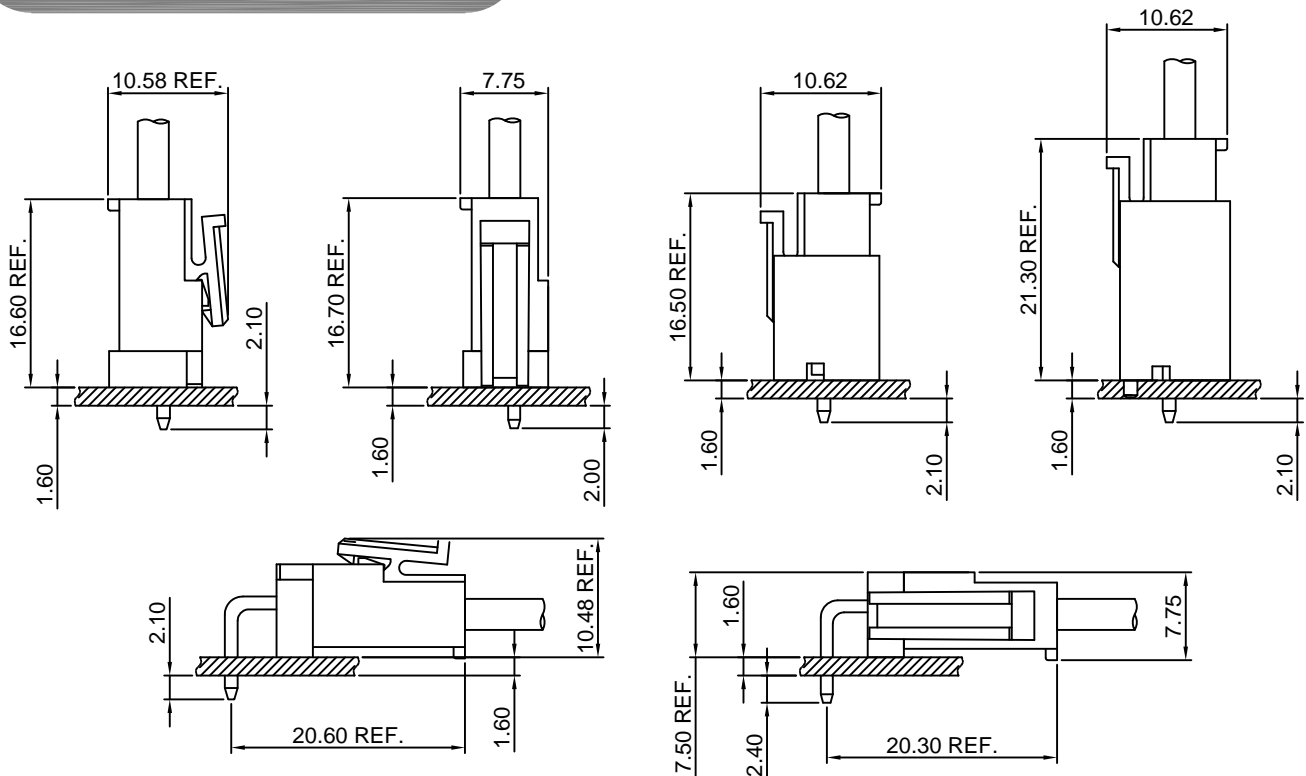

A3963-T

3.96mm pitch Crimp Terminal

Reference Informations:

*Used in CJT A3963H,HA,HB,HC-XP,A5001H,HA-XP,A7921H-2P series Housing

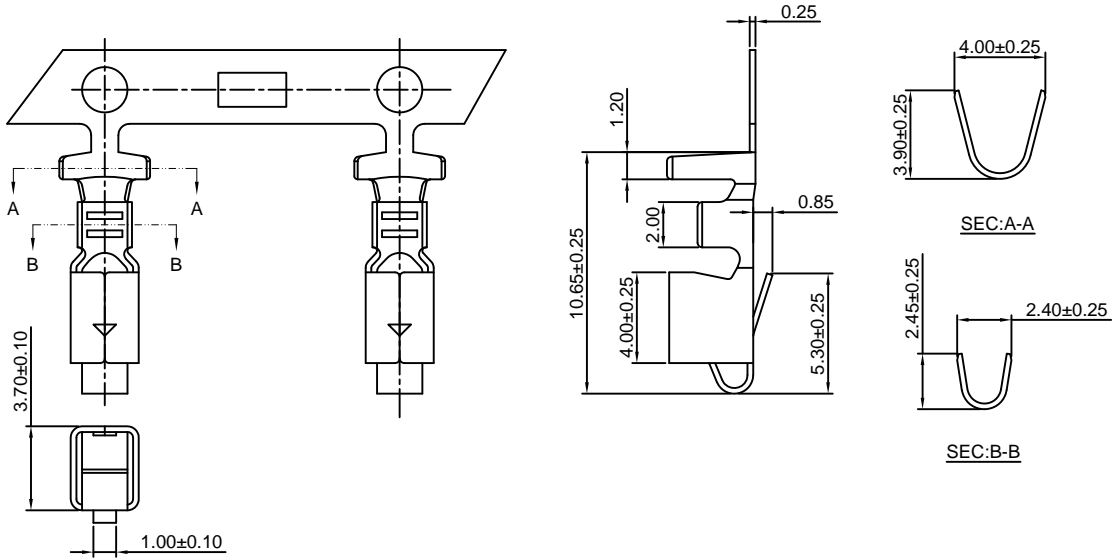

Ordering information & Specifications:

Unit:mm

Part NO.	Wire Range	Insulation O.D.	Material	Finish	Qty/reel
A3963-TB	AWG#18-#22	3.00mm(max)	Brass	Tin over Nickel	4,000 PCS
A3963-TP	AWG#18-#22	3.00mm(max)	Phosphor Bronze	Tin over Nickel	4,000 PCS
A3963-GB	AWG#18-#22	3.00mm(max)	Brass	Gold over Nickel	4,000 PCS
A3963-GP	AWG#18-#22	3.00mm(max)	Phosphor Bronze	Gold over Nickel	4,000 PCS

Optional Gold plating available but MOQ requested

A3963-T-H

3.96mm pitch Crimp Terminal

Reference Informations:

*Used in CJT A3963H,HA,HB,HC-XP,A5001H,HA-XP,A7921H-2P series Housing

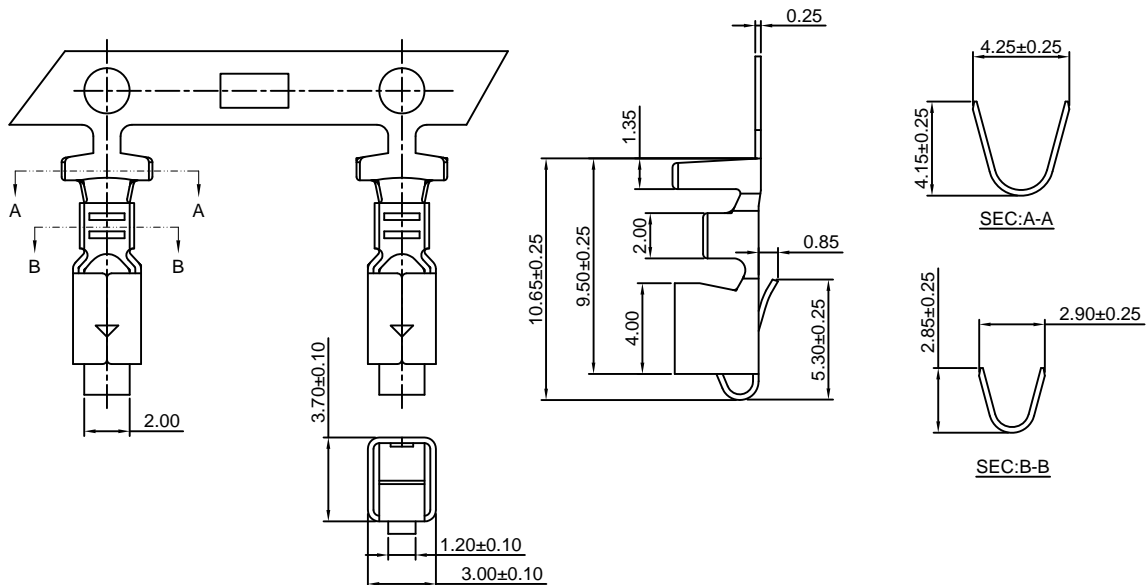

Ordering information & Specifications:

Unit:mm

Part NO.	Wire Range	Insulation O.D.	Material	Finish	Qty/reel
A3963-TB-H	AWG#16-#20	3.40mm(max)	Brass	Tin over Nickel	4,000 PCS
A3963-TP-H	AWG#16-#20	3.40mm(max)	Phosphor Bronze	Tin over Nickel	4,000 PCS
A3963-GB-H	AWG#16-#20	3.40mm(max)	Brass	Gold over Nickel	4,000 PCS
A3963-GP-H	AWG#16-#20	3.40mm(max)	Phosphor Bronze	Gold over Nickel	4,000 PCS

Optional Gold plating available but MOQ requested

A3963M-T

3.96mm pitch Crimp Terminal

Reference Informations:

*Used in CJT A3963HM-XP series Housing

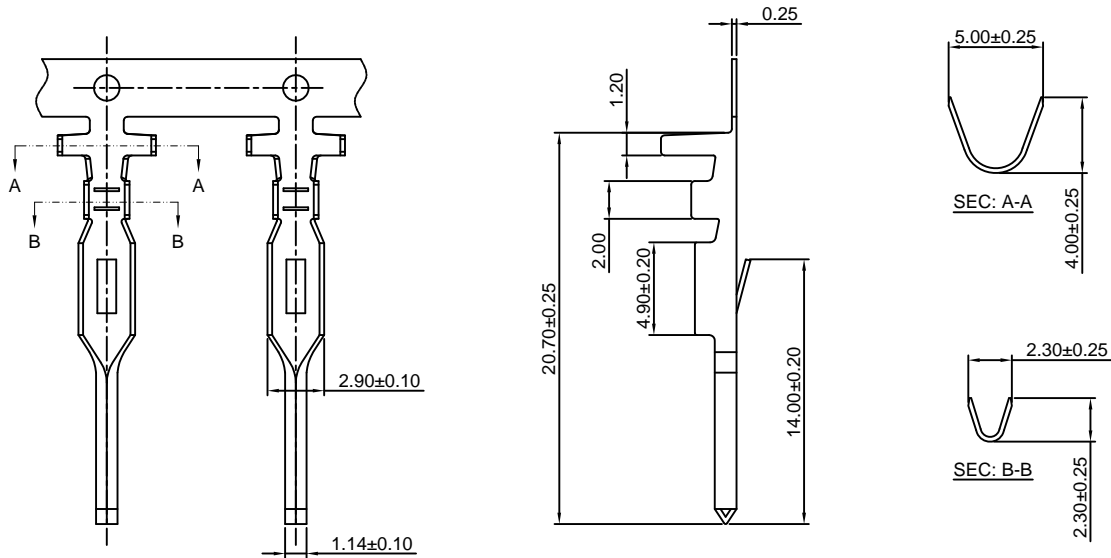

Ordering information & Specifications:

Unit:mm

Part NO.	Wire Range	Insulation O.D.	Material	Finish	Qty/reel
A3963M-TB	AWG#18-#22	3.00mm(max)	Brass	Tin over Nickel	4,000 PCS
A3963M-TP	AWG#18-#22	3.00mm(max)	Phosphor Bronze	Tin over Nickel	4,000 PCS
A3963M-GB	AWG#18-#22	3.00mm(max)	Brass	Gold over Nickel	4,000 PCS
A3963M-GP	AWG#18-#22	3.00mm(max)	Phosphor Bronze	Gold over Nickel	4,000 PCS

Optional Gold plating available but MOQ requested

A3963H-XP

3.96mm pitch Housing

Reference Informations:

*Material:Nylon 66,UL94V-0

*Suitable CJT A3963-T(-H) series Terminal

*Mates with CJT A3963WV,WR-XP(-A),A3963WVD,WRD-XP(-A),

A3963WVD-F-XP(-A),A3963WVD-F-XP-H(-A),

A3963WVD-S,WRD-S-XP(-A),A3963WRH-XP(-A),A7921WR-F-2P

Wafer or CJT A3963HM,HMA-XP Housing

*Color:White

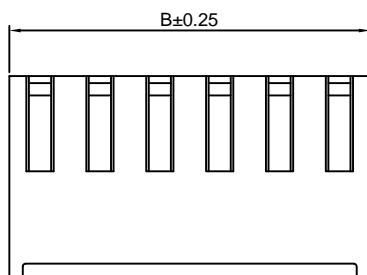
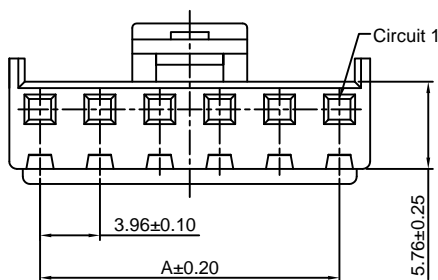
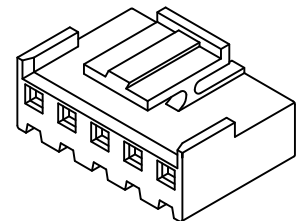

Ordering Information:

A3963H-XP - *** - **
1 2 3

1.Part No.

2.Material:

(blank):Nylon 66,UL94V-0

GWT:Nylon 66,UL94V-0,GWT 750°C

3.Color:

(Blank):White

BK:Black

BL:Blue

OR:Orange

PK:Pink

RD:Red

GN:Green

YL:Yellow

GY:Gray

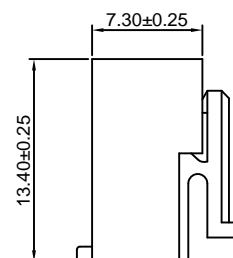

Ordering Information & Dimensions:

PART NO.	Dimensions	
	A	B
2P	3.96	8.02
3P	7.92	11.98
4P	11.88	15.94
5P	15.84	19.90
6P	19.80	23.86
7P	23.76	27.82
8P	27.72	31.78
9P	31.68	35.74
10P	35.64	39.70
11P	39.60	43.66
12P	43.56	47.62
13P	47.52	51.58
14P	51.48	55.54
15P	55.44	59.50

Unit: mm

A3963HA-XP

3.96mm pitch Housing

Reference Informations:

- *Material:Nylon 66,UL94V-0
- *Suitable CJT A3963-T(-H) series Terminal
- *Mates with CJT A3963WV,WR-XP(-A),A3963WVD,WRD-XP(-A),A3963WVD-F-XP(-A),A3963WVD-F-XP-H(-A),A3963WVD-S,WRD-S-XP(-A),A3963WRH-XP(-A) series Wafer
- *Color:White

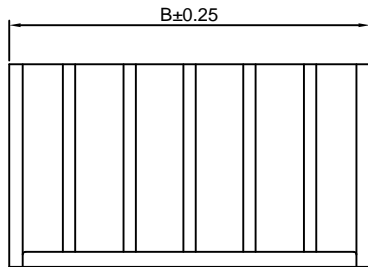
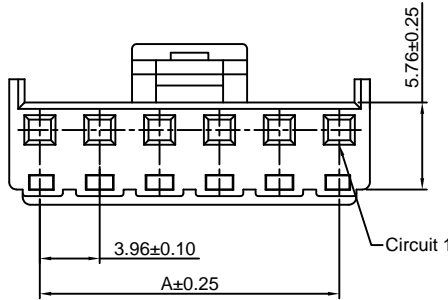

Ordering Information:
A3963HA-XP - *** - **
1 2 3

- 1.Part No.
- 2.Material:
(blank):Nylon 66,UL94V-0
GWT:Nylon 66,UL94V-0,GWT 750°C
- 3.Color:
(Blank):White
BK:Black RD:Red
BL:Blue GN:Green
OR:Orange YL:Yellow
PK:Pink GY:Gray

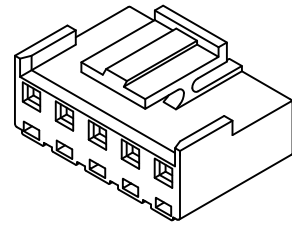

Ordering Information & Dimensions:

PART NO.	Dimensions	
	A	B
2P	3.96	8.02
3P	7.92	11.98
4P	11.88	15.94
5P	15.84	19.90
6P	19.80	23.86
7P	23.76	27.82
8P	27.72	31.78
9P	31.68	35.74
10P	35.64	39.70
11P	39.60	43.66
12P	43.56	47.62
13P	47.52	51.58
14P	51.48	55.54
15P	55.44	59.50

Unit: mm

A3963HB-XP

3.96mm pitch Housing

Reference Informations:

- *Material:Nylon 66,UL94V-0
- *Suitable CJT A3963-T(-H) series Terminal
- *Mates with CJT A3963WVB,WRB-XP(-A) series Wafer
- *Color:White

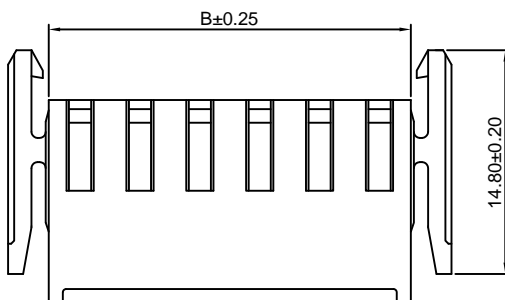
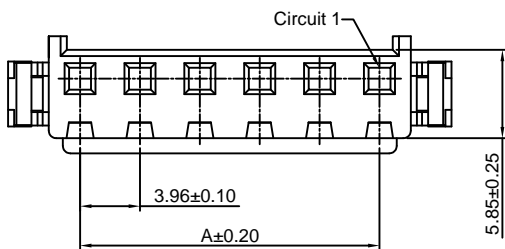

Ordering Information:
A3963HB-XP - ***
1 2

- 1.Part No.
- 2.Material:
(blank):Nylon 66,UL94V-0
GWT:Nylon 66,UL94V-0,GWT 750°C

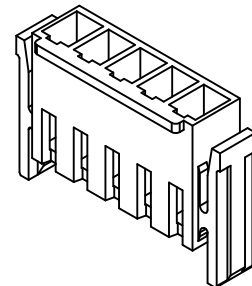

Ordering Information & Dimensions:

PART NO.	Dimensions	
	A	B
2P	3.96	8.10
3P	7.92	12.06
4P	11.88	16.02
5P	15.84	19.98
6P	19.80	23.94
7P	23.76	27.90
8P	27.72	31.86
9P	31.68	35.82
10P	35.64	39.78
11P	39.60	43.74
12P	43.56	47.70
13P	47.52	51.66
14P	51.48	55.62
15P	55.44	59.58

Unit: mm

A3963HC-XP

3.96mm pitch Housing

Reference Informations:

- *Material:Nylon 66,UL94V-0
- *Suitable CJT A3963-T(-H) series Terminal
- *Mates with CJT A3963S-XP series Interface Seal,
- A3963WV,WR-XP(-A),A3963WRH-XP(-A) series Wafer
- *Color:White

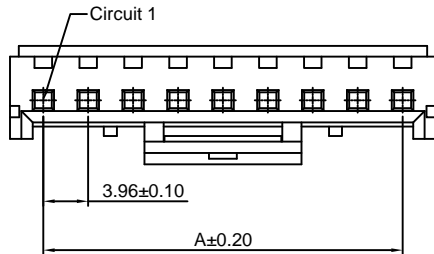
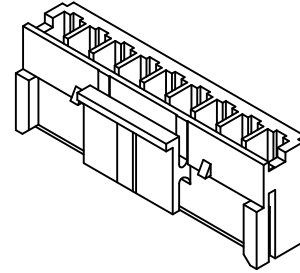

Ordering Information:

A3963HC-XP - ***
1 2

1.Part No.

2.Material:

(blank):Nylon 66,UL94V-0

GWT:Nylon 66,UL94V-0,GWT 750°C

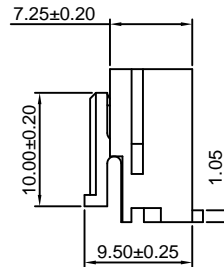
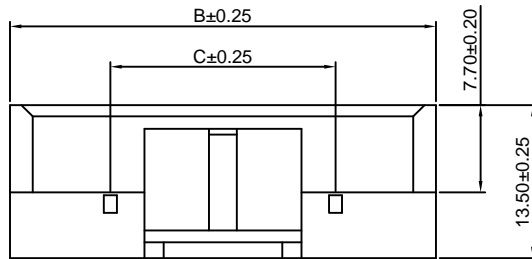

Ordering Information & Dimensions:

PART NO.	Dimensions		
	A	B	C
2P	3.96	9.63	----
3P	7.92	13.59	----
4P	11.88	17.55	----
5P	15.84	21.51	----
6P	19.80	25.47	----
7P	23.76	29.43	19.80
8P	27.72	33.39	19.80
9P	31.68	37.35	19.80
10P	35.64	41.31	19.80
11P	39.60	45.27	27.72
12P	43.56	49.23	27.72
13P	47.52	53.19	27.72
14P	51.48	57.15	27.72
15P	55.44	61.11	27.72

Unit: mm

A3963S-XP

3.96mm pitch Interface Seal

Reference Informations:

- *Material:Insulator:Nylon 66,UL94V-0
- *Mates with CJT A3963HC-XP series Housing
- *Color:Red

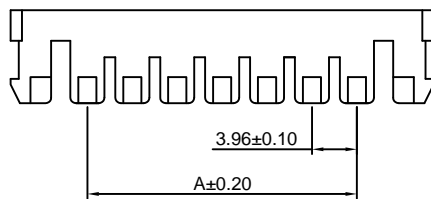
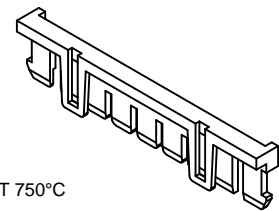

Ordering Information:

A3963S-XP - ***
1 2

1.Part No.

2.Material:

(blank):Nylon 66,UL94V-0

GWT:Nylon 66,UL94V-0,GWT 750°C

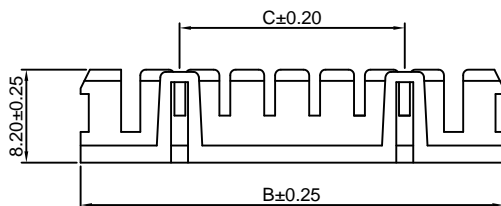
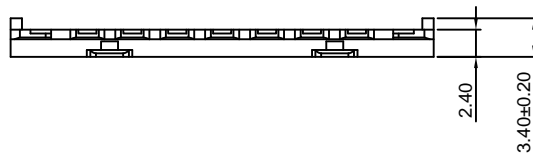

Ordering Information & Dimensions:

PART NO.	Dimensions		
	A	B	C
2P	----	9.58	----
3P	----	13.54	----
4P	3.96	17.50	----
5P	7.92	21.46	----
6P	11.88	25.42	----
7P	15.84	29.38	19.80
8P	19.80	33.34	19.80
9P	23.76	37.30	19.80
10P	27.72	41.26	19.80
11P	31.68	45.22	27.72
12P	35.64	49.18	27.72
13P	39.60	53.14	27.72
14P	43.56	57.10	27.72
15P	47.52	61.06	27.72

Unit: mm

A3963HM(A)-XP

3.96mm pitch Housing

Reference Informations:

- *Material:Nylon 66,UL94V-0
- *Suitable CJT A3963M-T series Terminal
- *Mates with CJT A3963H-XP series Housing
- *Color:White

Ordering Information:

- A3963HM(A)-XP - ^{**}/₂ - ^{**}/₃
- 1.Part No.
 - 2.Color:
(Blank):White
RD:Red
YL:Yellow
BL:Blue
BK:Black
GN:Green
 - 3.Material:
(Blank):Nylon 66,UL94V-0
GWT:Nylon 66,UL94V-0,GWT 750°C

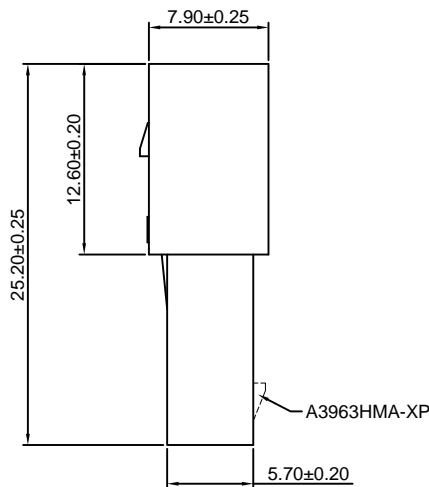
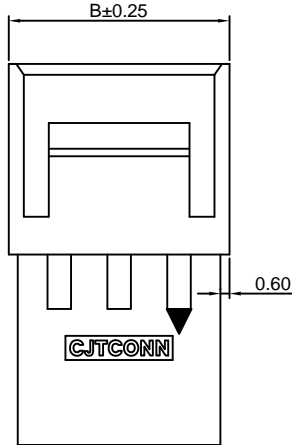
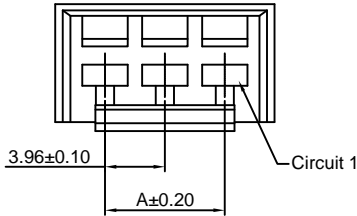
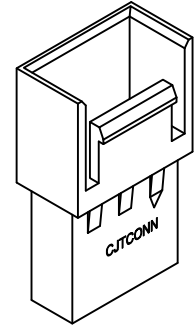

Ordering Information & Dimensions:

PART NO.	Dimensions	
	A	B
2P	3.96	10.64
3P	7.92	14.60
4P	11.88	18.56
5P	15.84	22.52
6P	19.80	26.48
7P	23.76	30.44
8P	27.72	34.40
9P	31.68	38.36
10P	35.64	42.32
11P	39.60	46.28
12P	43.56	50.24
13P	47.52	54.20
14P	51.48	58.16
15P	55.44	62.12

Unit: mm

A3963WV(-F1)-XP

3.96mm pitch 180° Wafer

Reference Informations:

- *Material:Pin:Brass/Tin over Nickel
Insulator:Nylon 66,UL94V-0
- *Mates with CJT A3963H,HA,HC-XP series Housing
- *Color:White

Ordering Information:

- A3963WV(-F1)-XP - ^{***}/₂ - ^{**}/₃ - ^{**}/₄
- 1.Part No.
 - 2.Material:
(blank):Nylon 66,UL94V-0
GWT:Nylon 66,UL94V-0,GWT 750°C
 - 3.Color:
(Blank):White
BK:Black
BL:Blue
OR:Orange
PK:Pink
RD:Red
GN:Green
YL:Yellow
GY:Gray
 - 4.Finish:
(blank):Tin over Nickel
G:Gold over Nickel

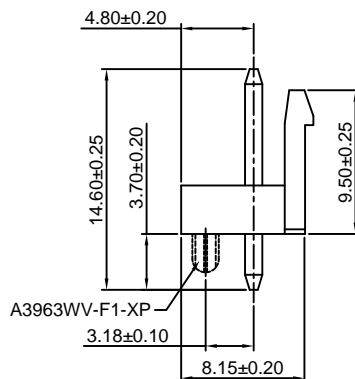
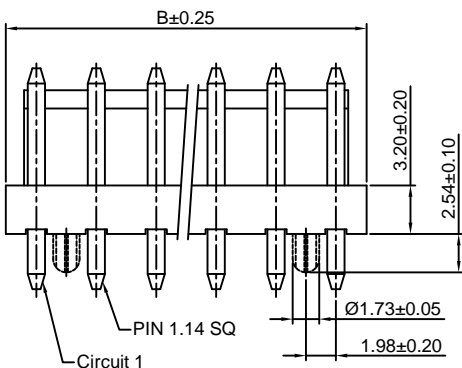
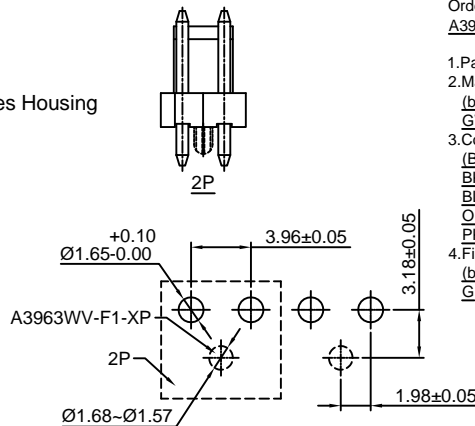
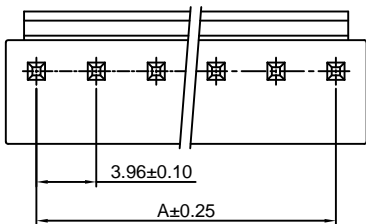
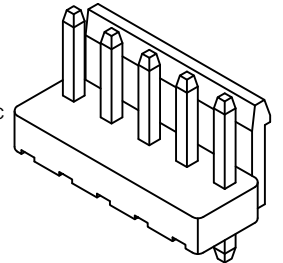

Ordering Information & Dimensions:

PART NO.	Dimensions	
	A	B
2P	3.96	7.92
3P	7.92	11.88
4P	11.88	15.84
5P	15.84	19.80
6P	19.80	23.76
7P	23.76	27.72
8P	27.72	31.68
9P	31.68	35.64
10P	35.64	39.60
11P	39.60	43.56
12P	43.56	47.52
13P	47.52	51.48
14P	51.48	55.44
15P	55.44	59.40

Unit: mm

A3963WR-XP

3.96mm pitch 90° Wafer

Reference Informations:

- *Material: Pin: Brass/Tin over Nickel
Insulator: Nylon 66, UL94V-0
- *Mates with CJT A3963H, HA, HC-XP series Housing
- *Color: White

Ordering Information:

A3963WR-XP - *** - ** - **
1 2 3 4

- Part No.
- Material:
(blank): Nylon 66, UL94V-0
GWT: Nylon 66, UL94V-0, GWT 750°C
- Color:
(Blank): White
BK: Black RD: Red
BL: Blue GN: Green
OR: Orange YL: Yellow
PK: Pink GY: Gray
- Finish:
(blank): Tin over Nickel
G: Gold over Nickel

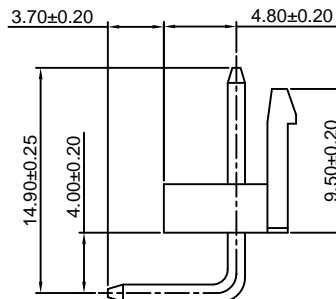
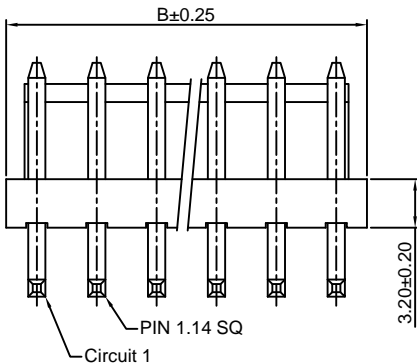
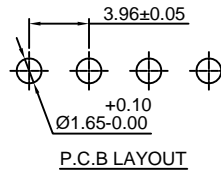
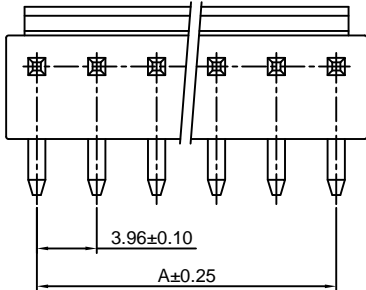
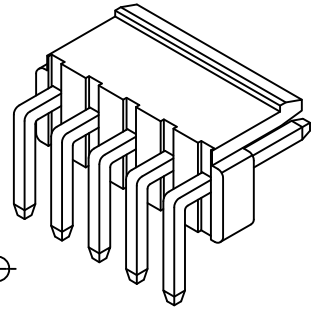

Ordering Information & Dimensions:

PART NO.	Dimensions	
	A	B
2P	3.96	7.92
3P	7.92	11.88
4P	11.88	15.84
5P	15.84	19.80
6P	19.80	23.76
7P	23.76	27.72
8P	27.72	31.68
9P	31.68	35.64
10P	35.64	39.60
11P	39.60	43.56
12P	43.56	47.52
13P	47.52	51.48
14P	51.48	55.44
15P	55.44	59.40

Unit: mm

A3963WVB-XP

3.96mm pitch 180° Wafer

Reference Informations:

- *Material: Pin: Brass/Tin over Nickel
Insulator: Nylon 66, UL94V-0
- *Mates with CJT A3963HB-XP series Housing
- *Color: White

Ordering Information:

A3963WVB-XP - *** - **
1 2 3

- Part No.
- Material:
(blank): Nylon 66, UL94V-0
GWT: Nylon 66, UL94V-0, GWT 750°C
- Finish:
(blank): Tin over Nickel
G: Gold over Nickel

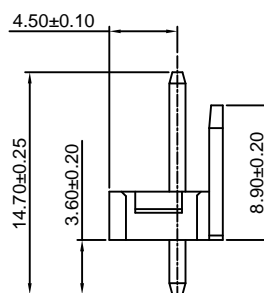
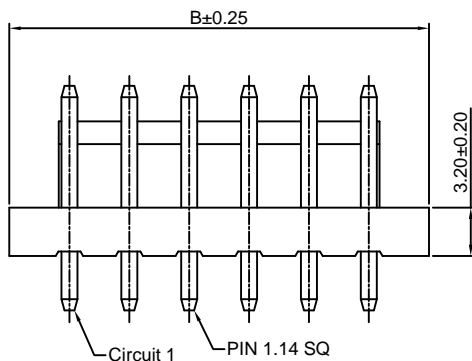
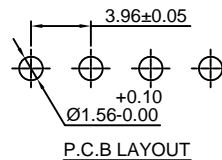
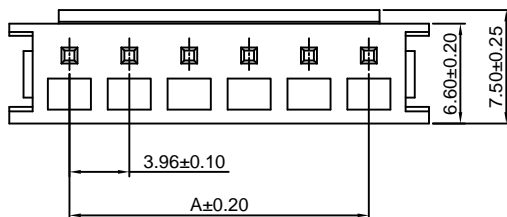
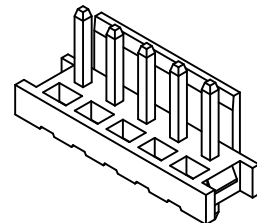

Ordering Information & Dimensions:

PART NO.	Dimensions	
	A	B
2P	3.96	11.92
3P	7.92	15.88
4P	11.88	19.84
5P	15.84	23.80
6P	19.80	27.76
7P	23.76	31.72
8P	27.72	35.68
9P	31.68	39.64
10P	35.64	43.60
11P	39.60	47.56
12P	43.56	51.52
13P	47.52	55.48
14P	51.48	59.44
15P	55.44	63.40

Unit: mm

A3963WRB-XP

3.96mm pitch 90° Wafer

Reference Informations:

- *Material: Pin: Brass/Tin over Nickel
Insulator: Nylon 66, UL94V-0
- *Mates with CJT A3963HB-XP series Housing
- *Color: Beige

Ordering Information:

A3963WRB-XP - *** - **
1 2 3

- Part No.
- Material:
(blank): Nylon 66, UL94V-0
GWT: Nylon 66, UL94V-0, GWT 750°C
- Finish:
(blank): Tin over Nickel
G: Gold over Nickel

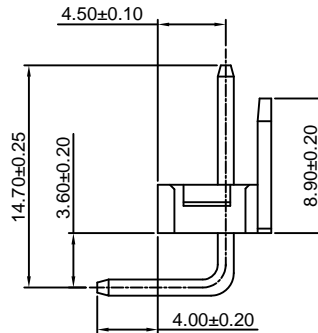
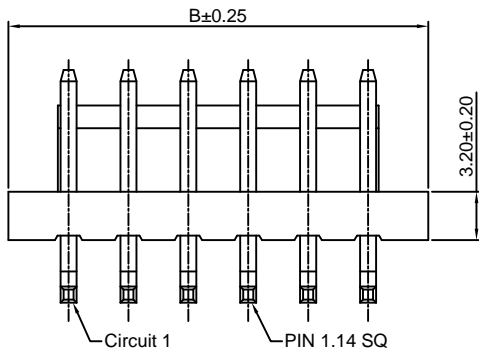
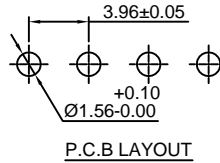
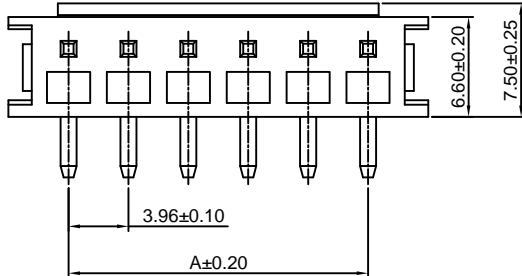
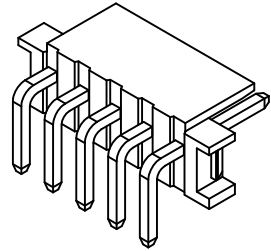

Ordering Information & Dimensions:

PART NO.	Dimensions	
	A	B
2P	3.96	11.92
3P	7.92	15.88
4P	11.88	19.84
5P	15.84	23.80
6P	19.80	27.76
7P	23.76	31.72
8P	27.72	35.68
9P	31.68	39.64
10P	35.64	43.60
11P	39.60	47.56
12P	43.56	51.52
13P	47.52	55.48
14P	51.48	59.44
15P	55.44	63.40

Unit: mm

A3963WVD-F-XP

3.96mm pitch 180° Wafer

Reference Informations:

- *Material: Pin: Brass/Tin over Nickel
Insulator: PBT+30%GF, UL94V-0
- *Mates with CJT A3963H, HA-XP series Housing
- *Color: White

Ordering Information:

A3963WVD-F-XP - *** - ** - **
1 2 3 4

- Part No.
- Material:
(blank): PBT+30%GF, UL94V-0
GWT: PBT, UL94V-0, GWT 750°C
- Color:
(Blank): White
BK: Black RD: Red
BL: Blue GN: Green
OR: Orange YL: Yellow
PK: Pink GY: Gray
- Finish:
(blank): Tin over Nickel
G: Gold over Nickel

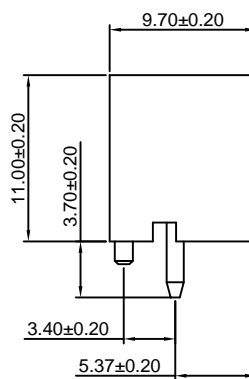
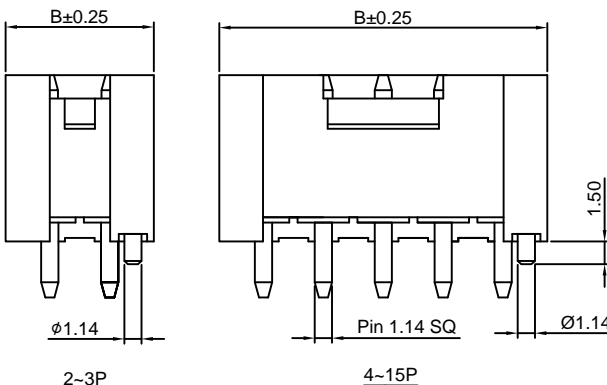
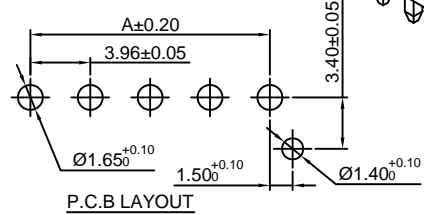
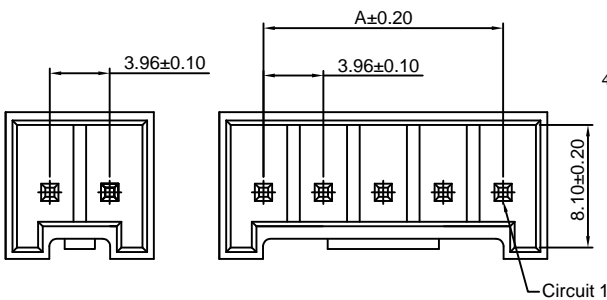
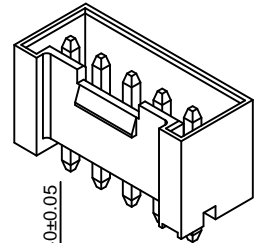

Ordering Information & Dimensions:

PART NO.	Dimensions	
	A	B
2P	3.96	9.80
3P	7.92	13.76
4P	11.88	17.72
5P	15.84	21.68
6P	19.80	25.64
7P	23.76	29.60
8P	27.72	33.56
9P	31.68	37.52
10P	35.64	41.48
11P	39.60	45.44
12P	43.56	49.40
13P	47.52	53.36
14P	51.48	57.32
15P	55.44	61.28

Unit: mm

A3963WVD-F1-XP

3.96mm pitch 180° Wafer

Reference Informations:

- *Material: Pin: Brass/Tin over Nickel
Insulator: PBT, UL94V-0
- *Mates with CJT A3963H, HA-XP series Housing
- *Color: White

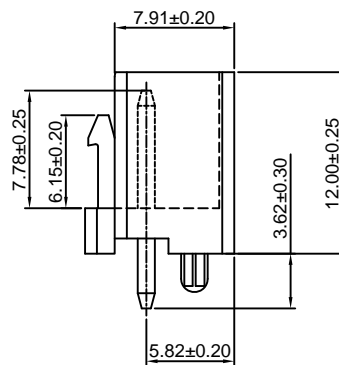
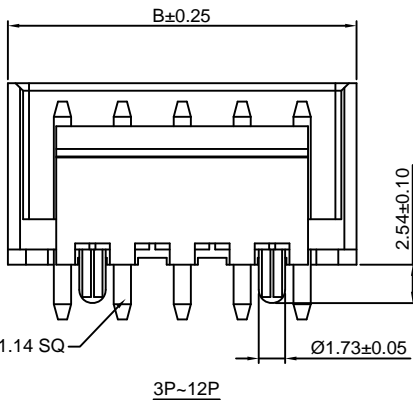
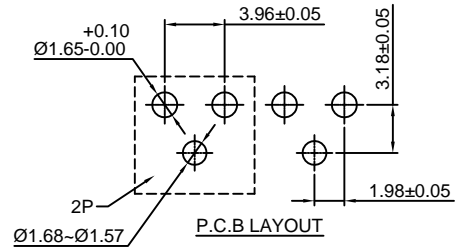
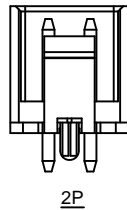
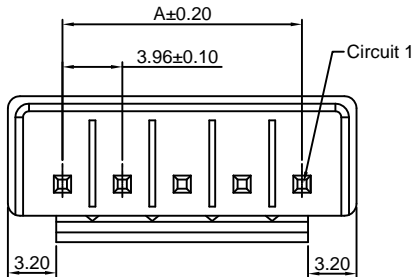
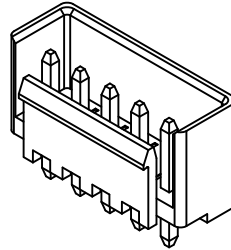

Ordering Information & Dimensions:

PART NO.	Dimensions	
	A	B
2P	3.96	11.17
3P	7.92	15.13
4P	11.88	19.09
5P	15.84	23.05
6P	19.80	27.01
7P	23.76	30.97
8P	27.72	34.93
9P	31.68	38.89
10P	35.64	42.85
11P	39.60	46.81
12P	43.56	50.77

Unit: mm

A3963WVD-FT-XP

3.96mm pitch 180° Wafer

Reference Informations:

- *Material: Pin: Brass/Tin over Nickel
Insulator: PBT, UL94V-0
- *Mates with CJT A3963H, HA-XP series Housing
- *Color: White

Ordering Information:
A3963WVD-FT-XP - **
1 2

- 1.Part No.
- 2.Color:
(blank):White
BK:Black

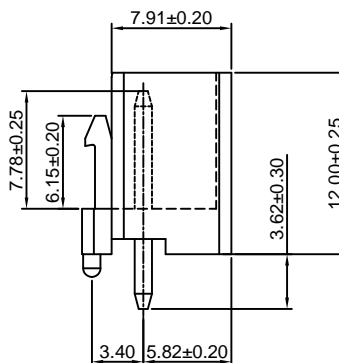
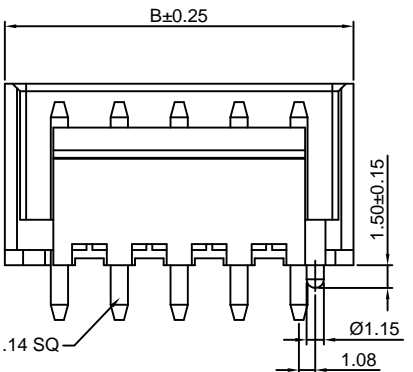
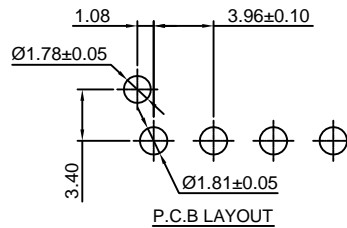
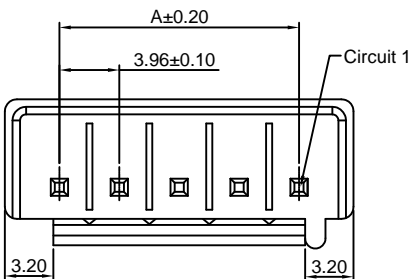
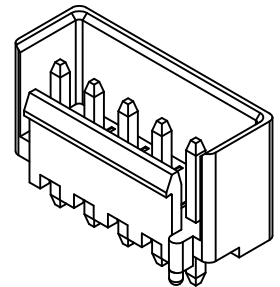

Ordering Information & Dimensions:

PART NO.	Dimensions	
	A	B
2P	3.96	11.17
3P	7.92	15.13
4P	11.88	19.09
5P	15.84	23.05
6P	19.80	27.01
7P	23.76	30.97
8P	27.72	34.93
9P	31.68	38.89
10P	35.64	42.85
11P	39.60	46.81
12P	43.56	50.77

Unit: mm

A3963WRD-XP

3.96mm pitch 90° Wafer

Reference Informations:

- *Material:Pin:Brass/Tin over Nickel
Insulator:PBT+30%GF,UL94V-0
- *Mates with CJT A3963H,HA-XP series Housing
- *Color:White

Ordering Information:

A3963WRD-XP - $\frac{***}{1} - \frac{**}{2} - \frac{**}{3}$

- 1.Part No.
- 2.Material:
(blank):PBT+30%GF,UL94V-0
GWT:PBT,UL94V-0,GWT 750°C
- 3.Finish:
(blank):Tin over Nickel
G:Gold over Nickel

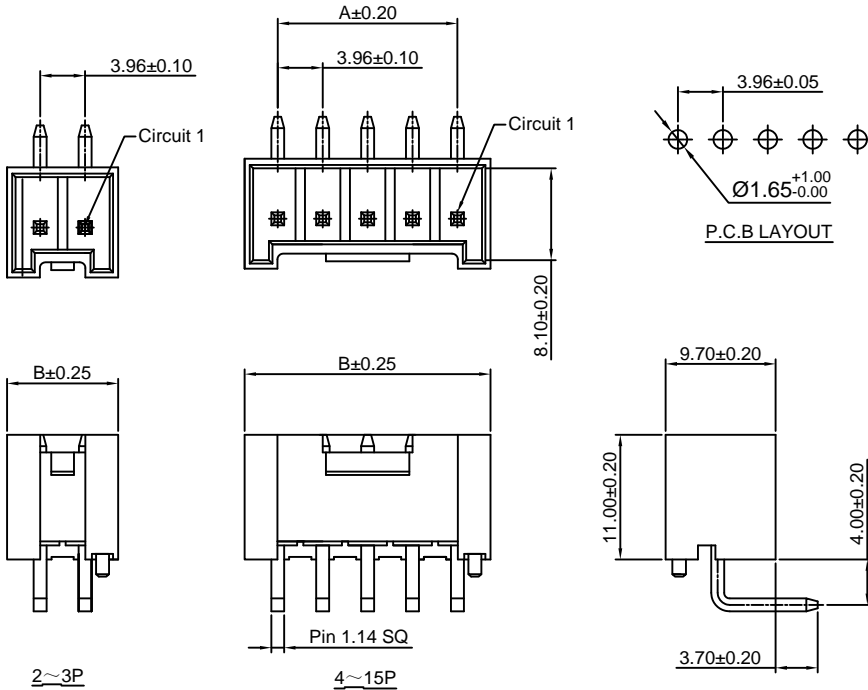

Ordering Information & Dimensions:

PART NO.	Dimensions	
	A	B
2P	3.96	9.80
3P	7.92	13.76
4P	11.88	17.72
5P	15.84	21.68
6P	19.80	25.64
7P	23.76	29.60
8P	27.72	33.56
9P	31.68	37.52
10P	35.64	41.48
11P	39.60	45.44
12P	43.56	49.40
13P	47.52	53.36
14P	51.48	57.32
15P	55.44	61.28

Unit: mm

A3963WRD-XP-A

3.96mm pitch 90° Wafer

Reference Informations:

- *Material:Pin:Brass/Tin over Nickel
Insulator:PBT+30%GF,UL94V-0
- *Mates with CJT A3963H,HA-XP series Housing
- *Color:White

Ordering Information:

A3963WRD-XP-A - $\frac{***}{1} - \frac{**}{2} - \frac{**}{3}$

- 1.Part No.
- 2.Material:
(blank):PBT+30%GF,UL94V-0
GWT:PBT,UL94V-0,GWT 750°C
- 3.Finish:
(blank):Tin over Nickel
G:Gold over Nickel

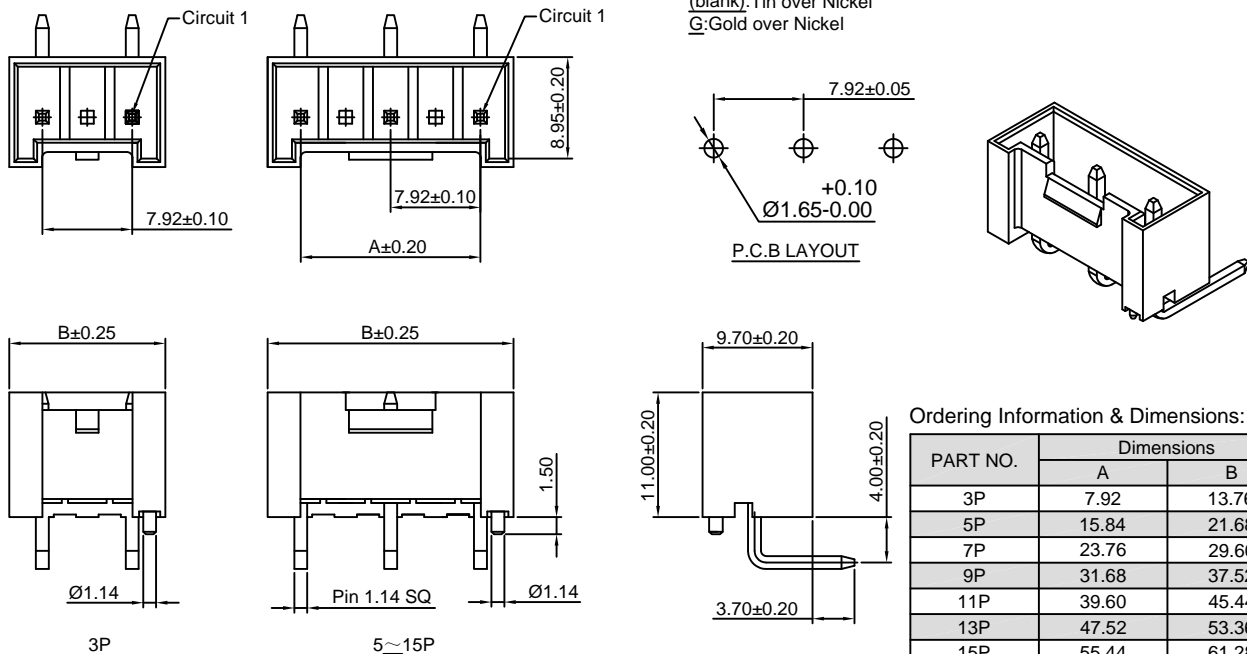

Ordering Information & Dimensions:

PART NO.	Dimensions	
	A	B
3P	7.92	13.76
5P	15.84	21.68
7P	23.76	29.60
9P	31.68	37.52
11P	39.60	45.44
13P	47.52	53.36
15P	55.44	61.28

A3963WVD-S-XP

3.96mm pitch 180° Wafer - SMT TYPE

Reference Informations:

- *Material: Pin: Phosphor Bronze/Tin over Nickel
Insulator: Nylon 9T, UL94V-0
- *Mates with CJT A3963H, HA-XP series Housing
- *Color: Ivory

Ordering Information:

- A3963WVD-S-XP - *** - **
 1 2 3
1. Part No.
 2. Material:
(blank): Nylon 9T, UL94V-0
GWT: Nylon 9T, UL94V-0, GWT 750°C
 3. Finish:
(blank): Tin over Nickel
G: Gold over Nickel

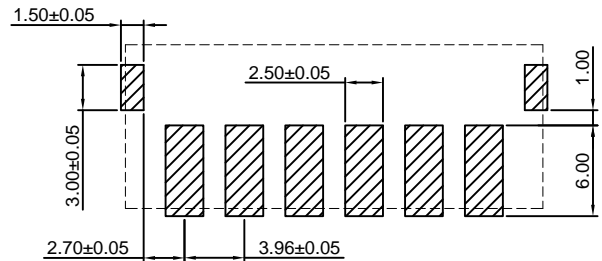
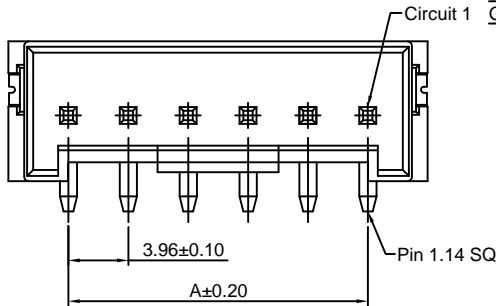

P.C.B LAYOUT

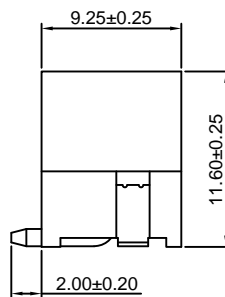
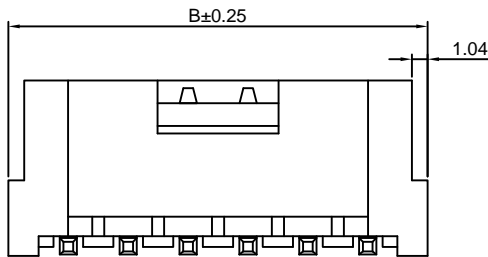

Ordering Information & Dimensions:

PART NO.	Dimensions	
	A	B
2P	3.96	11.88
3P	7.92	15.84
4P	11.88	19.80
5P	15.84	23.76
6P	19.80	27.72
7P	23.76	31.68
8P	27.72	35.64
9P	31.68	39.60
10P	35.64	43.56

Unit: mm

A3963WRD-S-XP

3.96mm pitch 90° Wafer - SMT TYPE

Reference Informations:

- *Material: Pin: Phosphor Bronze/Tin over Nickel
Insulator: Nylon 9T, UL94V-0
- *Mates with CJT A3963H, HA-XP series Housing
- *Color: Ivory

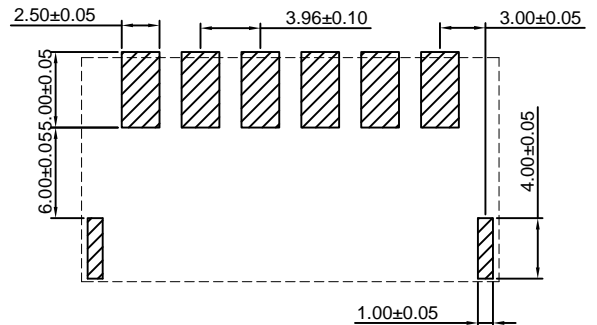

P.C.B LAYOUT

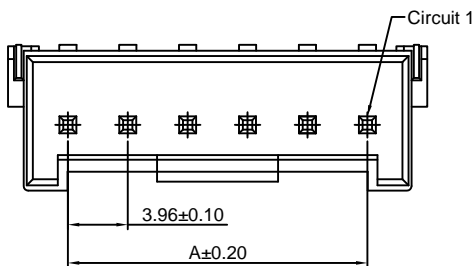

Ordering Information:

- A3963WRD-S-XP - *** - **
 1 2 3
1. Part No.
 2. Material:
(blank): Nylon 9T, UL94V-0
GWT: Nylon 9T, UL94V-0, GWT 750°C
 3. Finish:
(blank): Tin over Nickel
G: Gold over Nickel

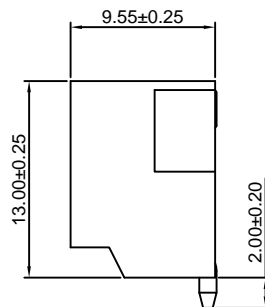
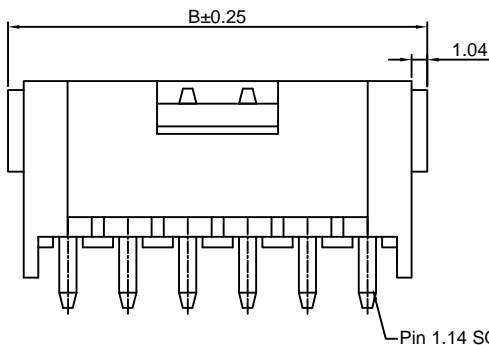

Ordering Information & Dimensions:

PART NO.	Dimensions	
	A	B
2P	3.96	11.88
3P	7.92	15.84
4P	11.88	19.80
5P	15.84	23.76
6P	19.80	27.72
7P	23.76	31.68
8P	27.72	35.64
9P	31.68	39.60
10P	35.64	43.56

Unit: mm

A3963WV-XP-A

7.92mm pitch 180° Wafer

Reference Informations:

- *Material: Pin: Brass/Tin over Nickel
Insulator: Nylon 66, UL94V-0
- *Mates with CJT A3963H, HA, HC-XP, A7921H-2P series Housing
- *Color: White

Ordering Information:

A3963WV-XP-A - *** - ** - **
1 2 3 4

1. Part No.
2. Material:
(blank): Nylon 66, UL94V-0
GWT: Nylon 66, UL94V-0, GWT 750°C
3. Color:
(Blank): White
BK: Black RD: Red
BL: Blue GN: Green
OR: Orange YL: Yellow
PK: Pink GY: Gray
4. Finish:
(blank): Tin over Nickel
G: Gold over Nickel

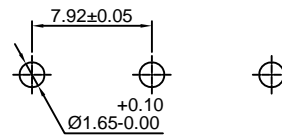
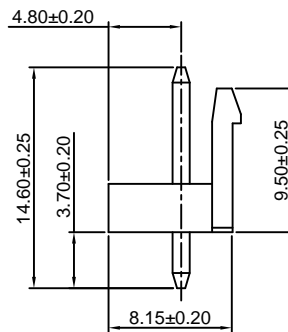
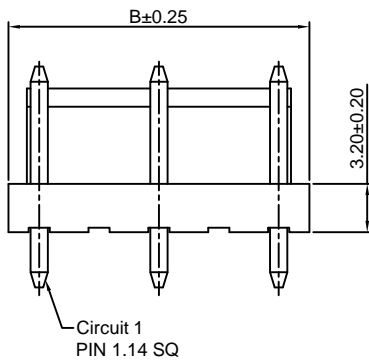
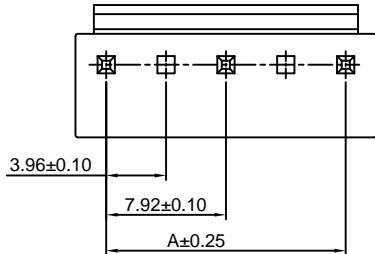
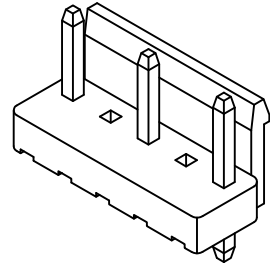

P.C.B LAYOUT

Ordering Information & Dimensions:

PART NO.	Dimensions	
	A	B
3P	7.92	11.88
5P	15.84	19.80
7P	23.76	27.72
9P	31.68	35.64
11P	39.60	43.56
13P	47.52	51.48
15P	55.44	59.40

Unit: mm

A3963WR-XP-A

7.92mm pitch 90° Wafer

Reference Informations:

- *Material: Pin: Brass/Tin over Nickel
Insulator: Nylon 66, UL94V-0
- *Mates with CJT A3963H, HA, HC-XP, A7921H-2P series Housing
- *Color: White

Ordering Information:

A3963WR-XP-A - *** - ** - **
1 2 3 4

1. Part No.
2. Material:
(blank): Nylon 66, UL94V-0
GWT: Nylon 66, UL94V-0, GWT 750°C
3. Color:
(Blank): White
BK: Black RD: Red
BL: Blue GN: Green
OR: Orange YL: Yellow
PK: Pink GY: Gray
4. Finish:
(blank): Tin over Nickel
G: Gold over Nickel

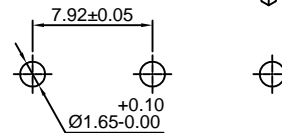
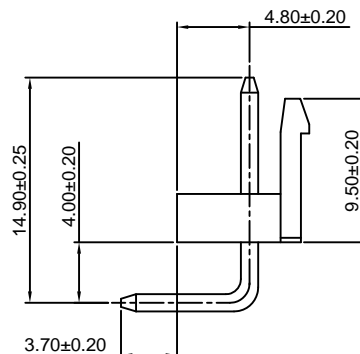
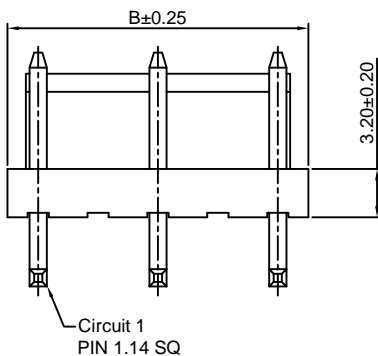
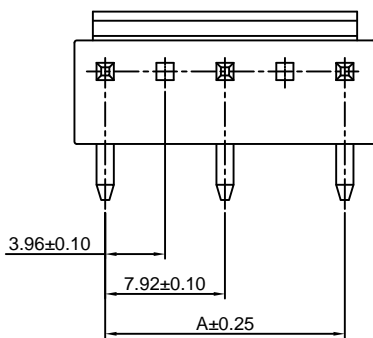
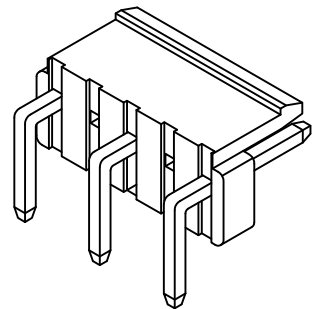

P.C.B LAYOUT

Ordering Information & Dimensions:

PART NO.	Dimensions	
	A	B
3P	7.92	11.88
5P	15.84	19.80
7P	23.76	27.72
9P	31.68	35.64
11P	39.60	43.56
13P	47.52	51.48
15P	55.44	59.40

Unit: mm

A3963WVB-XP-A

7.92mm pitch 180° Wafer

Reference Informations:

- *Material: Pin: Brass/Tin over Nickel
Insulator: Nylon 66, UL94V-0
- *Mates with CJT A3963HB-XP series Housing
- *Color: White

Ordering Information:

- A3963WVB-XP-A - ^{***}/₁ - ^{**}/₂ - ^{**}/₃
1. Part No.
 2. Material:
(blank): Nylon 66, UL94V-0
GWT: Nylon 66, UL94V-0, GWT 750°C
 3. Finish:
(blank): Tin over Nickel
G: Gold over Nickel

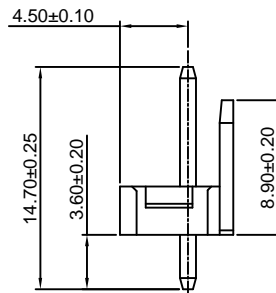
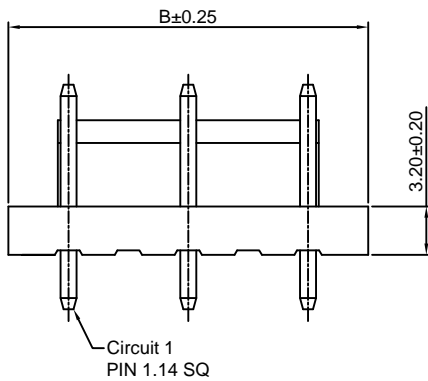
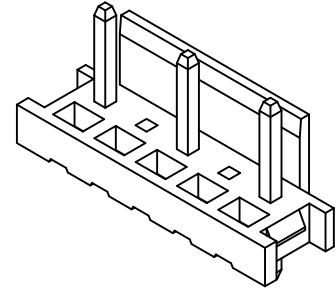
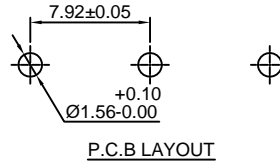
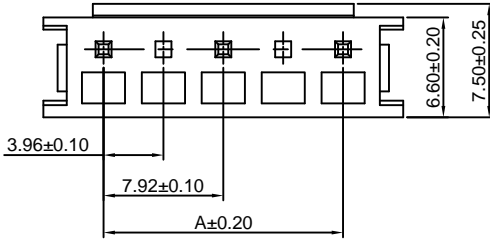

Ordering Information & Dimensions:

PART NO.	Dimensions	
	A	B
3P	7.92	15.88
5P	15.84	23.80
7P	23.76	31.72
9P	31.68	39.64
11P	39.60	47.56
13P	47.52	55.48
15P	55.44	63.40

Unit: mm

A3963WRB-XP-A

7.92mm pitch 90° Wafer

Reference Informations:

- *Material: Pin: Brass/Tin over Nickel
Insulator: Nylon 66, UL94V-0
- *Mates with CJT A3963HB-XP series Housing
- *Color: White

Ordering Information:

- A3963WRB-XP-A - ^{***}/₁ - ^{**}/₂ - ^{**}/₃
1. Part No.
 2. Material:
(blank): Nylon 66, UL94V-0
GWT: Nylon 66, UL94V-0, GWT 750°C
 3. Finish:
(blank): Tin over Nickel
G: Gold over Nickel

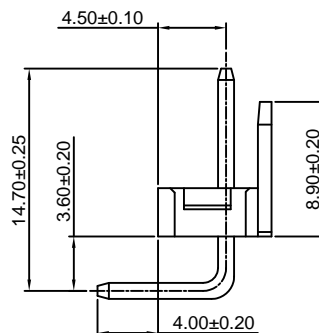
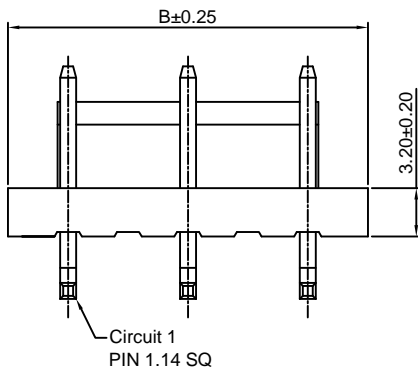
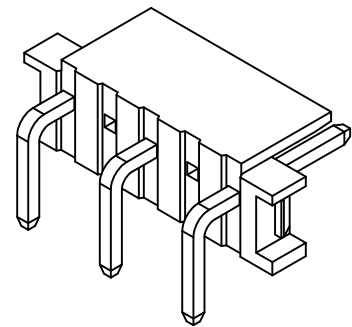
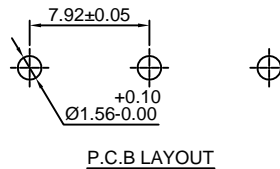
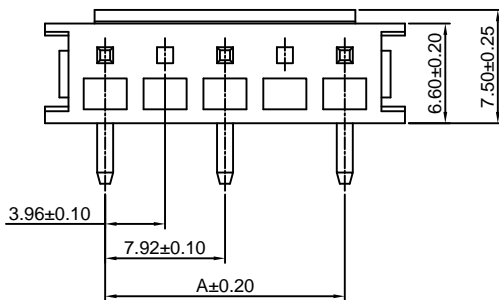

Ordering Information & Dimensions:

PART NO.	Dimensions	
	A	B
3P	7.92	15.88
5P	15.84	23.80
7P	23.76	31.72
9P	31.68	39.64
11P	39.60	47.56
13P	47.52	55.48
15P	55.44	63.40

Unit: mm

A3963WVD-F-XP-H

3.96mm pitch 180° Wafer

Reference Informations:

- *Material: Pin: Brass/Tin over Nickel
Insulator: PBT+30%GF, UL94V-0
- *Mates with CJT A3963H, HA-XP series Housing
- *Color: White

- Ordering Information:
A3963WVD-F-XP-H - ^{***} - ^{**} - ^{**}
1. Part No.
2. Material:
(blank): PBT+30%GF, UL94V-0
GWT: PBT, UL94V-0, GWT 750°C
3. Color:
(Blank): White
BK: Black
BL: Blue
OR: Orange
PK: Pink
4. Finish:
(blank): Tin over Nickel
G: Gold over Nickel
- RD: Red
GN: Green
YL: Yellow
GY: Gray

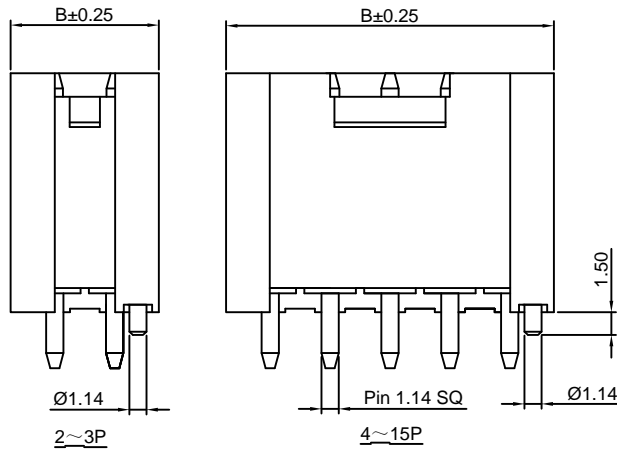
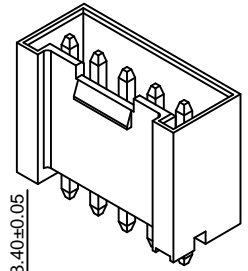
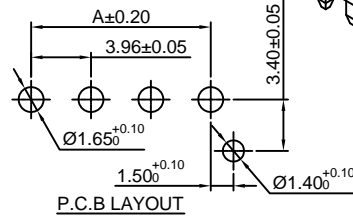
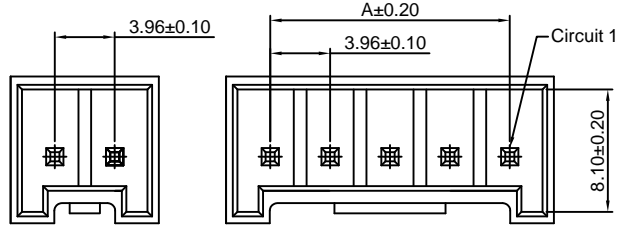

Ordering Information & Dimensions:

PART NO.	Dimensions	
	A	B
2P	3.96	9.80
3P	7.92	13.76
4P	11.88	17.72
5P	15.84	21.68
6P	19.80	25.64
7P	23.76	29.60
8P	27.72	33.56
9P	31.68	37.52
10P	35.64	41.48
11P	39.60	45.44
12P	43.56	49.40
13P	47.52	53.36
14P	51.48	57.32
15P	55.44	61.28

Unit: mm

A3963WVD-F-XP-H-A

7.92mm pitch 180° Wafer

Reference Informations:

- *Material: Pin: Brass/Tin over Nickel
Insulator: PBT+30%GF, UL94V-0
- *Mates with CJT A3963H, HA-XP series Housing
- *Color: White

- Ordering Information:
A3963WVD-F-XP-H-A - ^{***} - ^{**} - ^{**}
1. Part No.
2. Material:
(blank): PBT+30%GF, UL94V-0
GWT: PBT, UL94V-0, GWT 750°C
3. Color:
(Blank): White
BK: Black
BL: Blue
OR: Orange
PK: Pink
4. Finish:
(blank): Tin over Nickel
G: Gold over Nickel
- RD: Red
GN: Green
YL: Yellow
GY: Gray

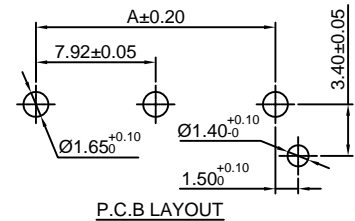
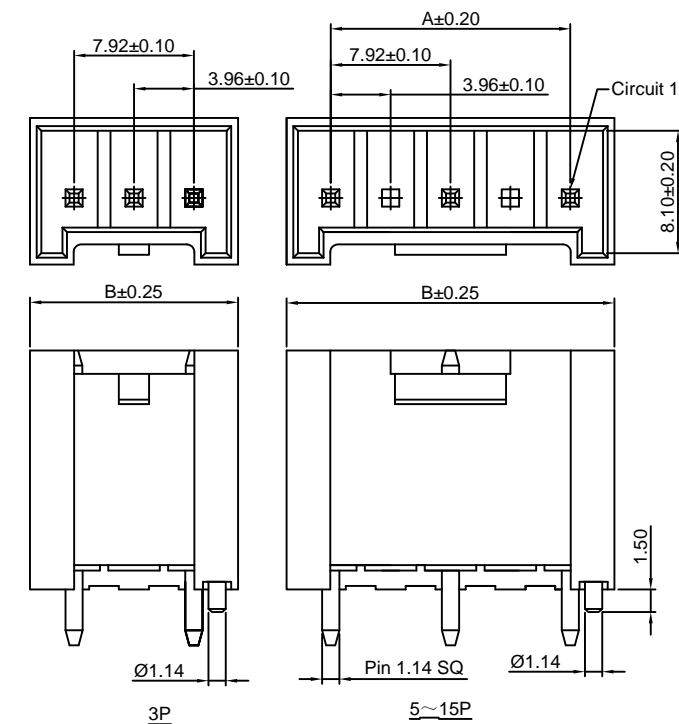
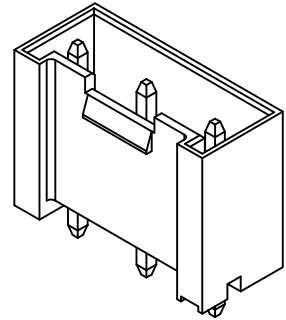

Ordering Information & Dimensions:

PART NO.	Dimensions	
	A	B
3P	7.92	13.76
5P	15.84	21.68
7P	23.76	29.60
9P	31.68	37.52
11P	39.60	45.44
13P	47.52	53.36
15P	55.44	61.28

Unit: mm

A3963WVD-F-XP-A

7.92mm pitch 180° Wafer

Reference Informations:

- *Material: Pin: Brass/Tin over Nickel
Insulator: PBT+30%GF, UL94V-0
- *Mates with CJT A3963H, HA-XP series Housing
- *Color: White

Ordering Information:

A3963WVD-F-XP-A - *** - ** - **
1 2 3 4

- Part No.
- Material:
(blank): PBT+30%GF, UL94V-0
GWT: PBT, UL94V-0, GWT 750°C
- Color:
(Blank): White
BK: Black RD: Red
BL: Blue GN: Green
OR: Orange YL: Yellow
PK: Pink GY: Gray
- Finish:
(blank): Tin over Nickel
G: Gold over Nickel

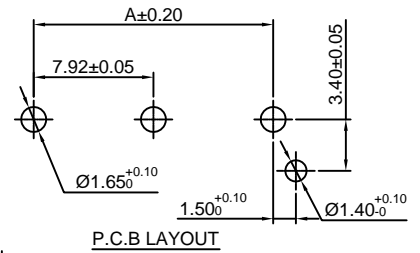
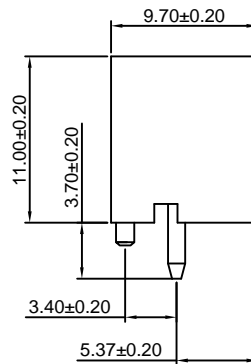
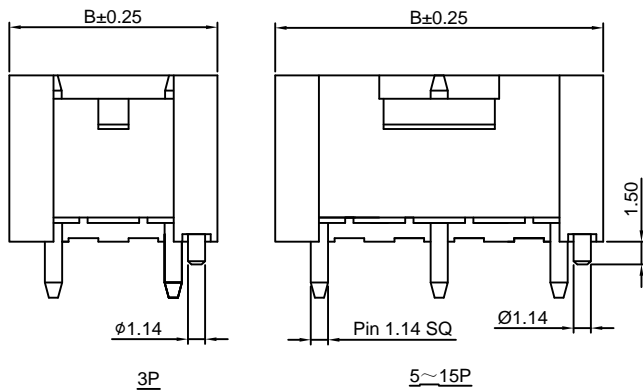
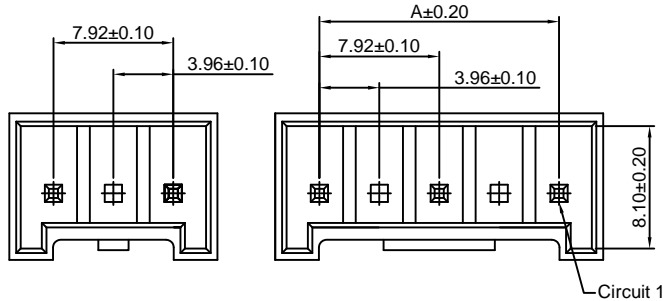
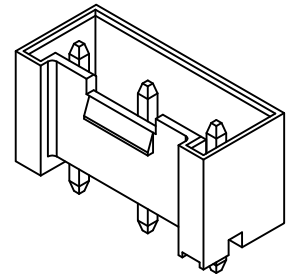

Ordering Information & Dimensions:

PART NO.	Dimensions	
	A	B
3P	7.92	13.76
5P	15.84	21.68
7P	23.76	29.60
9P	31.68	37.52
11P	39.60	45.44
13P	47.52	53.36
15P	55.44	61.28

Unit: mm

A3963WVD-S-XP-A

7.92mm pitch 180° Wafer - SMT TYPE

Reference Informations:

- *Material: Pin: Phosphor Bronze/Tin over Nickel
Insulator: Nylon 9T, UL94V-0
- *Mates with CJT A3963H, HA-XP series Housing
- *Color: Ivory

Ordering Information:

A3963WVD-S-XP-A - *** - **
1 2 3

- Part No.
- Material:
(blank): Nylon 9T, UL94V-0
GWT: Nylon 9T, UL94V-0, GWT 750°C
- Finish:
(blank): Tin over Nickel
G: Gold over Nickel

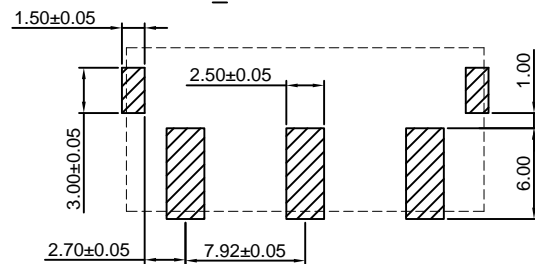
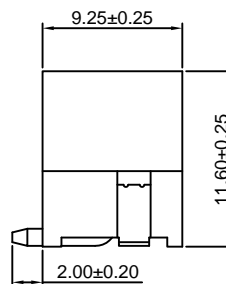
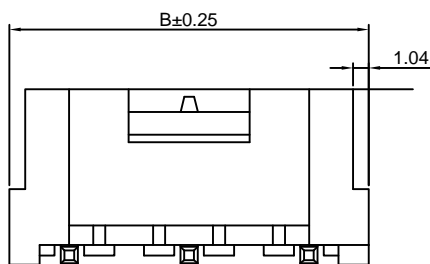
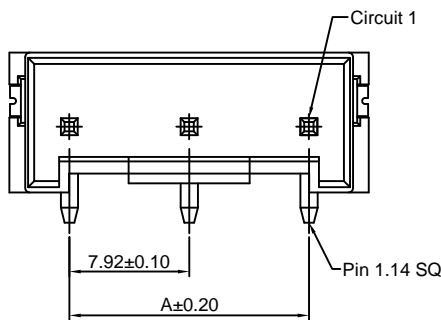

P.C.B LAYOUT

Ordering Information & Dimensions:

PART NO.	Dimensions	
	A	B
3P	7.92	15.84
5P	15.84	23.76
7P	23.76	31.68
9P	31.68	39.60

Unit: mm

A3963WRD-S-XP-A

7.92mm pitch 90° Wafer - SMT TYPE

Reference Informations:

- *Material: Pin: Phosphor Bronze/Tin over Nickel
Insulator: Nylon 9T, UL94V-0
- *Mates with CJT A3963H, HA-XP series Housing
- *Color: Ivory

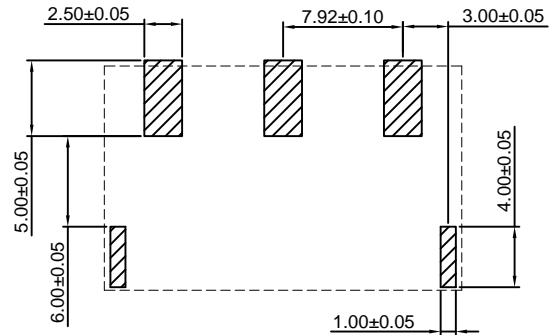
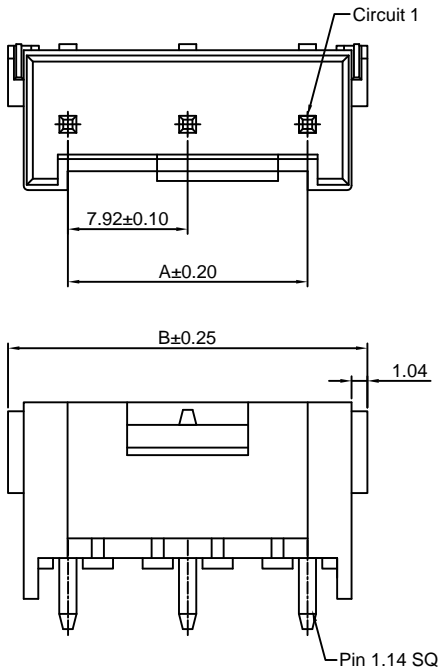

P.C.B LAYOUT

Ordering Information:
A3963WRD-S-XP-A - *** - **
1 2 3

- Part No.
- Material:
(blank): Nylon 9T, UL94V-0
GWT: Nylon 9T, UL94V-0, GWT 750°C
- Finish:
(blank): Tin over Nickel
G: Gold over Nickel

Ordering Information & Dimensions:

PART NO.	Dimensions	
	A	B
3P	7.92	15.84
5P	15.84	23.76
7P	23.76	31.68
9P	31.68	39.60

Unit: mm

A3963WRH-XP

3.96mm pitch 90° Wafer

Reference Informations:

- *Material: Pin: Brass/Tin over Nickel
Insulator: Nylon 66, UL94V-0
- *Mates with CJT A3963H, HA, HC-XP series Housing
- *Color: White

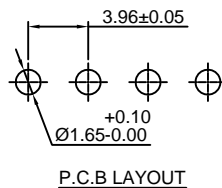
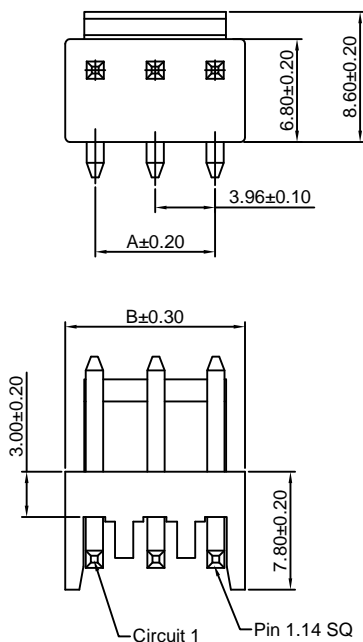

Ordering Information:
A3963WRH-XP - *** - ** - **
1 2 3 4

- Part No.
- Material:
(blank): Nylon 66, UL94V-0
GWT: Nylon 66, UL94V-0, GWT 750°C
- Color:
(Blank): White
BK: Black
RD: Red
BL: Blue
GN: Green
YL: Yellow
- Finish:
(blank): Tin over Nickel
G: Gold over Nickel

Ordering Information & Dimensions:

PART NO.	Dimensions	
	A	B
2P	3.96	7.92
3P	7.92	11.88
4P	11.88	15.84
5P	15.84	19.80
6P	19.80	23.76
7P	23.76	27.72
8P	27.72	31.68
9P	31.68	35.64
10P	35.64	39.60
11P	39.60	43.56
12P	43.56	47.52
13P	47.52	51.48
14P	51.48	55.44
15P	55.44	59.40

A3963WRH-XP-A

7.92mm pitch 90° Wafer

Reference Informations:

- *Material: Pin: Brass/Tin over Nickel
Insulator: Nylon 66, UL94V-0
- *Mates with CJT A3963H, HA, HC-XP series Housing
- *Color: White

Ordering Information:

A3963WRH-XP-A - ^{***}/₂ - ^{**}/₃ - ^{**}/₄

1. Part No.
2. Material:
(blank): Nylon 66, UL94V-0
GWT: Nylon 66, UL94V-0, GWT 750°C
3. Color:
(Blank): White
BK: Black
RD: Red
BL: Blue
GN: Green
YL: Yellow
4. Finish:
(blank): Tin over Nickel
G: Gold over Nickel

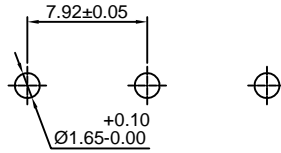
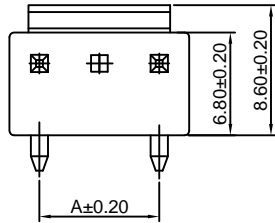

P.C.B LAYOUT

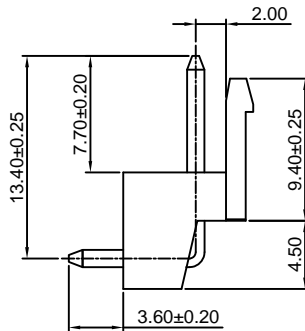
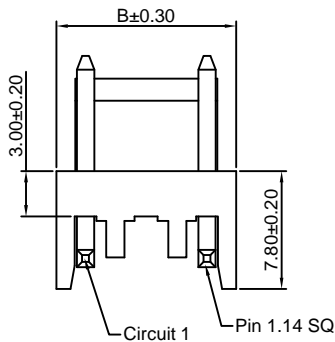

Ordering Information & Dimensions:

PART NO.	Dimensions	
	A	B
3P	7.92	11.88
5P	15.84	19.80
7P	23.76	27.72
9P	31.68	35.64
11P	39.60	43.56
13P	47.52	51.48
15P	55.44	59.40

Unit: mm

A7921WR-F-2P

7.92mm pitch 90° Wafer

Reference Informations:

- *Material: Pin: Brass/Tin over Nickel
Insulator: PBT, UL94V-0
- *Mates with CJT A3963H-3P Housing
- *Color: White

Ordering Information:

A7921WR-F-2P - ^{***}/₂ - ^{**}/₃

1. Part No.
2. Material:
(blank): PBT, UL94V-0
GWT: PBT, UL94V-0, GWT 750°C
3. Finish:
(blank): Tin over Nickel
G: Gold over Nickel

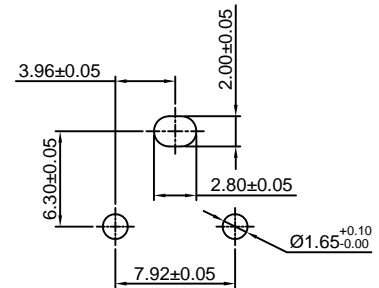
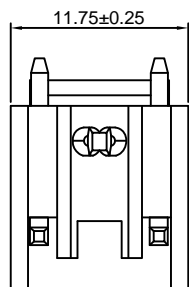
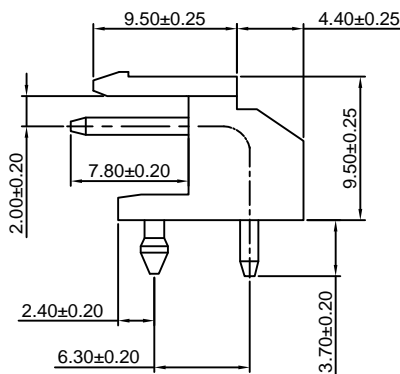
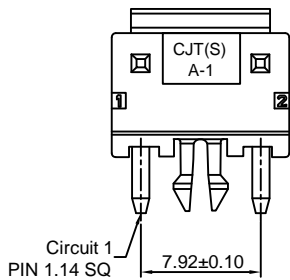

P.C.B LAYOUT

Unit: mm

X-ON Electronics

Largest Supplier of Electrical and Electronic Components

Click to view similar products for [Headers & Wire Housings](#) category:

Click to view products by [Changjiang](#) manufacturer:

Other Similar products are found below :

[95000-104TRLF](#) [10135584-644402LF](#) [DF62W-EP2022PCA](#) [95000-106TRLF](#) [DF62W-2022SCA](#) [DF62W-EP2022PC](#) [2203348](#) [DF62W-2022SC](#) [1084018](#) [1029039](#) [1084017](#) [802-10-012-10-002000](#) [1112640](#) [1112639](#) [891-007-9SS-BST1T](#) [000-34000](#) [0008550134](#) [0009482033](#) [0009507031](#) [57102-F02-18ULF](#) [57102-S06-03LF](#) [57202-S52-04LF](#) [PCN6-15S-2.5E](#) [0039019024](#) [58102-G61-06LF](#) [582553-1](#) [0009485154](#) [0009508121](#) [0022285053](#) [0050291907](#) [018731A](#) [LY20-4P-DT1-P1E-BR](#) [02.125.8002.8](#) [60101931](#) [60598-1 \(Cut Strip\)](#) [M1625-3R/100](#) [61062-3](#) [61082-181009](#) [CSU011177004](#) [636-1427](#) [638009-1](#) [641938-9](#) [641991-4](#) [644168-1](#) [644827-2](#) [647662-1](#) [65039-019ELF](#) [65692-001LF](#) [65781-018](#) [65781-047](#)