

## Specifications

- Current rating: 7A AC, DC
- Voltage rating: 250V AC, DC
- Temperature range: -40°C ~ +105°C
- Contact resistance: 10mΩ Max.
- Insulation resistance: 1000MΩ Min.
- Withstanding voltage: 1500V AC/minute
- \*Compliant with RoHS and REACH\*
- \*Meet the HF/Halogen Free, GWT/Glow wire Test (IEC60335-1) request, need to customize\*
- \*Contact CJT for details\*

## Standards



## Assembly layout

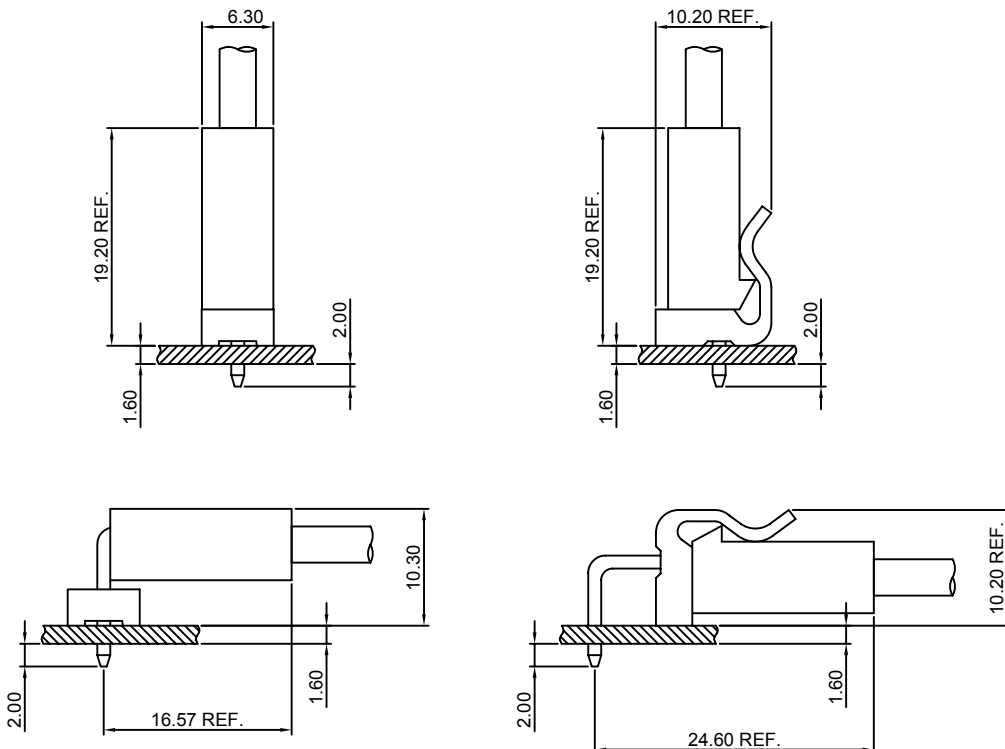

### A5081H-XP

5.08mm pitch Housing

#### Reference Informations:

- \*Material:Nylon 66,UL94V-2
- \*Suitable CJT A3961-T(-1) series Terminal
- \*Mates with CJT A5081WV,WR,WVA,WRA-XP(-A),A5081WVB-XP A5081WV-XP-R(-A),A5081WVA-XP-R(-A) series Wafer
- \*Color:Natural

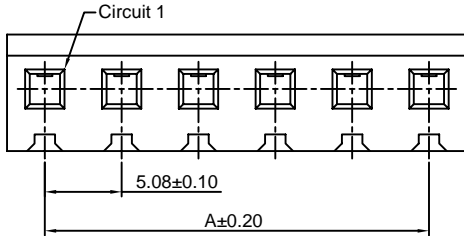
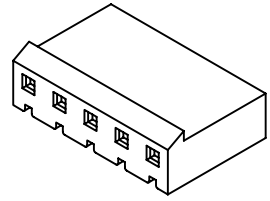

#### Ordering Information:

A5081H-XP - \* - \*\*\*  
1 2 3

- 1.Part No.
- 2.Style:  
(blank)-Type 1  
2-Type 2
- 3.Material:  
(blank)-Nylon 66,UL94V-2(Natural)  
V0-Nylon 66,UL94V-0(White)  
GWT-Nylon 66,UL94V-0,GWT 750°C

#### Ordering Information & Dimensions:

PART NO.	Dimensions	
	A	B
2P	5.08	10.08
3P	10.16	15.16
4P	15.24	20.24
5P	20.32	25.32
6P	25.40	30.40
7P	30.48	35.48
8P	35.56	40.56
9P	40.64	45.64
10P	45.72	50.72
11P	50.80	55.80
12P	55.88	60.88
13P	60.96	65.96
14P	66.04	71.04
15P	71.12	76.12
16P	76.20	81.20
17P	81.28	86.28
18P	86.36	91.36
19P	91.44	96.44
20P	96.52	101.52

Unit: mm

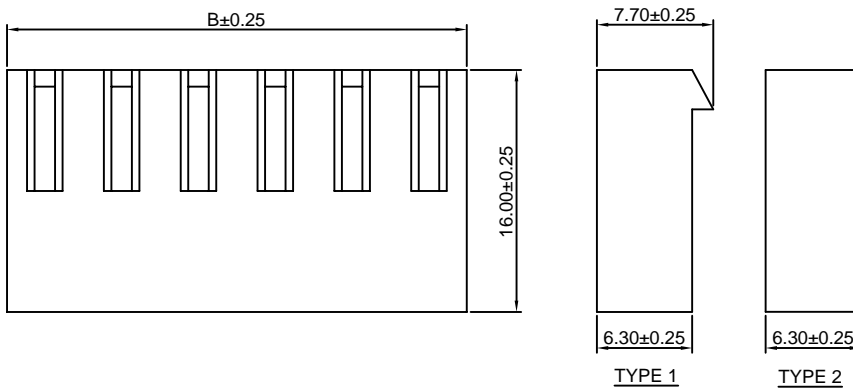

### A5081WV-XP

5.08mm pitch 180° Wafer

#### Reference Informations:

- \*Material:Pin:Brass/Tin over Nickel  
Insulator:Nylon 66,UL94V-2
- \*Mates with CJT A5081H-XP,A5082H-XP, A5082H-XP-A series Housing
- \*Color:Natural

#### Ordering Information:

A5081WV-XP - \*\*\* - \*\*  
1 2 3

- 1.Part No.
- 2.Material:  
(blank):Nylon 66,UL94V-2(Natural)  
V0:Nylon 66,UL94V-0(White)  
GWT:Nylon 66,UL94V-0,GWT 750°C
- 3.Finish:  
(blank):Tin over Nickel  
G:Gold over Nickel

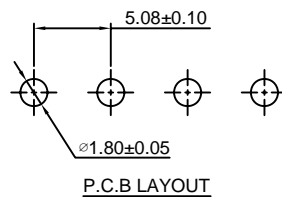
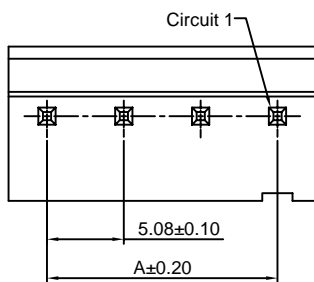
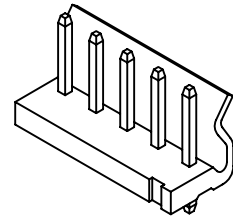

#### Ordering Information & Dimensions:

PART NO.	Dimensions	
	A	B
2P	5.08	10.16
3P	10.16	15.24
4P	15.24	20.32
5P	20.32	25.40
6P	25.40	30.48
7P	30.48	35.56
8P	35.56	40.64
9P	40.64	45.72
10P	45.72	50.80
11P	50.80	55.88
12P	55.88	60.96
13P	60.96	66.04
14P	66.04	71.12
15P	71.12	76.20
16P	76.20	81.28
17P	81.28	86.36
18P	86.36	91.44
19P	91.44	96.52
20P	96.52	101.60

Unit: mm

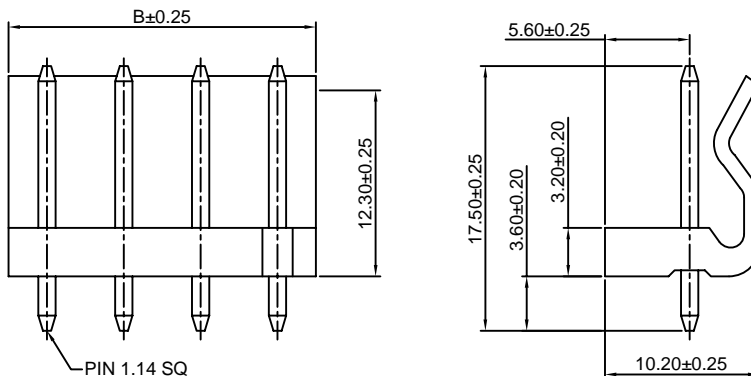

### A5081WR-XP

5.08mm pitch 90° Wafer

**Reference Informations:**

- \*Material: Pin: Brass/Tin over Nickel  
Insulator: Nylon 66, UL94V-2
- \*Mates with CJT A5081H-XP, A5082H-XP, A5082H-XP-A series Housing
- \*Color: Natural

**Ordering Information:**

- A5081WR-XP -  $\frac{***}{2} - \frac{**}{3}$
1. Part No.
  2. Material:  
(blank): Nylon 66, UL94V-2 (Natural)  
V0: Nylon 66, UL94V-0 (White)  
GWT: Nylon 66, UL94V-0, GWT 750°C
  3. Finish:  
(blank): Tin over Nickel  
G: Gold over Nickel

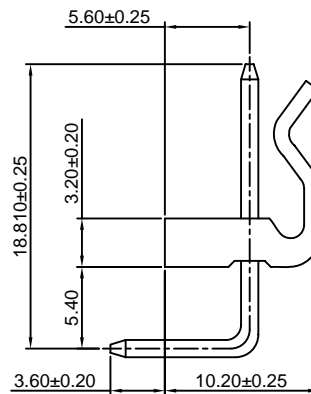
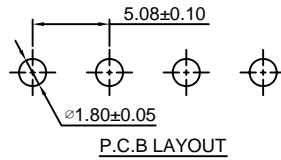
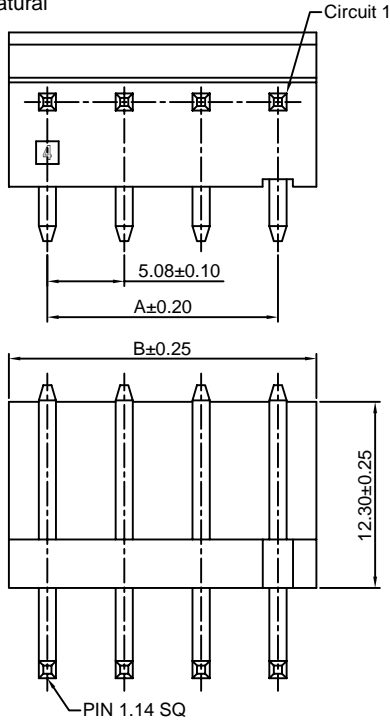
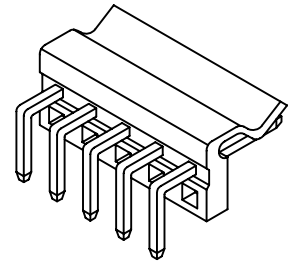

**Ordering Information & Dimensions:**

PART NO.	Dimensions	
	A	B
2P	5.08	10.16
3P	10.16	15.24
4P	15.24	20.32
5P	20.32	25.40
6P	25.40	30.48
7P	30.48	35.56
8P	35.56	40.64
9P	40.64	45.72
10P	45.72	50.80
11P	50.80	55.88
12P	55.88	60.96
13P	60.96	66.04
14P	66.04	71.12
15P	71.12	76.20
16P	76.20	81.28
17P	81.28	86.36
18P	86.36	91.44
19P	91.44	96.52
20P	96.52	101.60

Unit: mm

### A5081WVA-XP

5.08mm pitch 180° Wafer

**Reference Informations:**

- \*Material: Pin: Brass/Tin over Nickel  
Insulator: Nylon 66, UL94V-2
- \*Mates with CJT A5081H-XP, A5082H-XP, A5082H-XP-A series Housing
- \*Color: Natural

**Ordering Information:**

- A5081WVA-XP -  $\frac{***}{2} - \frac{**}{3}$
1. Part No.
  2. Material:  
(blank): Nylon 66, UL94V-2 (Natural)  
V0: Nylon 66, UL94V-0 (White)  
GWT: Nylon 66, UL94V-0, GWT 750°C
  3. Finish:  
(blank): Tin over Nickel  
G: Gold over Nickel

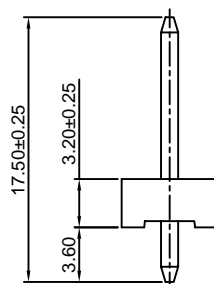
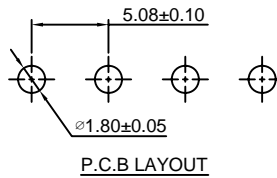
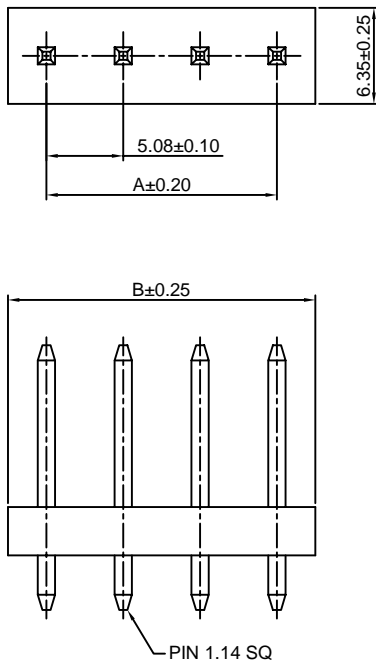
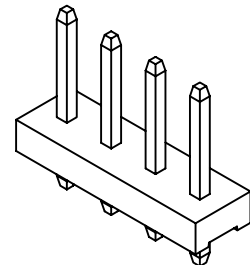

**Ordering Information & Dimensions:**

PART NO.	Dimensions	
	A	B
2P	5.08	10.16
3P	10.16	15.24
4P	15.24	20.32
5P	20.32	25.40
6P	25.40	30.48
7P	30.48	35.56
8P	35.56	40.64
9P	40.64	45.72
10P	45.72	50.80
11P	50.80	55.88
12P	55.88	60.96
13P	60.96	66.04
14P	66.04	71.12
15P	71.12	76.20
16P	76.20	81.28
17P	81.28	86.36
18P	86.36	91.44
19P	91.44	96.52
20P	96.52	101.60

Unit: mm

### A5081WRA-XP

5.08mm pitch 90° Wafer

**Reference Informations:**

- \*Material: Pin: Brass/Tin over Nickel  
Insulator: Nylon 66, UL94V-2
- \*Mates with CJT A5081H-XP, A5082H-XP, A5082H-XP-A series Housing
- \*Color: Natural

**Ordering Information:**

A5081WRA-XP - \*\*\* - \*\*  
1 2 3

1. Part No.
2. Material:  
(blank): Nylon 66, UL94V-2 (Natural)  
V0: Nylon 66, UL94V-0 (White)  
GWT: Nylon 66, UL94V-0, GWT 750°C
3. Finish:  
(blank): Tin over Nickel  
G: Gold over Nickel

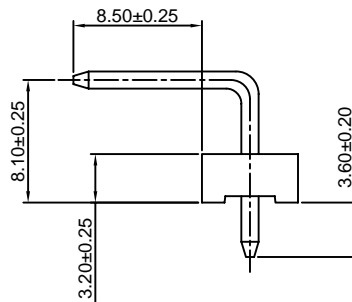
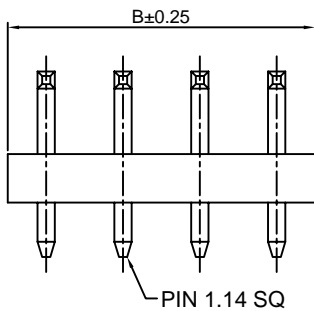
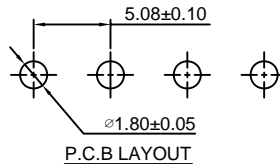
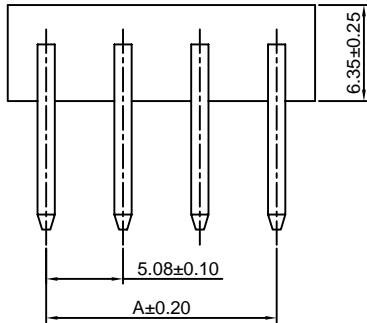
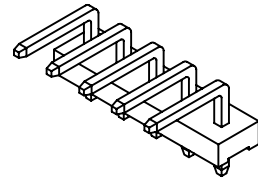

**Ordering Information & Dimensions:**

PART NO.	Dimensions	
	A	B
2P	5.08	10.16
3P	10.16	15.24
4P	15.24	20.32
5P	20.32	25.40
6P	25.40	30.48
7P	30.48	35.56
8P	35.56	40.64
9P	40.64	45.72
10P	45.72	50.80
11P	50.80	55.88
12P	55.88	60.96
13P	60.96	66.04
14P	66.04	71.12
15P	71.12	76.20
16P	76.20	81.28
17P	81.28	86.36
18P	86.36	91.44
19P	91.44	96.52
20P	96.52	101.60

Unit: mm

### A5081WVB-XP

5.08mm pitch 180° Wafer

**Reference Informations:**

- \*Material: Pin: Brass/Tin over Nickel  
Insulator: Nylon 66, UL94V-2
- \*Mates with CJT A5081H-XP, A5082H-XP, A5082H-XP-A series Housing
- \*Color: Natural

**Ordering Information:**

A5081WVB-XP - \*\*\* - \*\*  
1 2 3

1. Part No.
2. Material:  
(blank): Nylon 66, UL94V-2 (Natural)  
V0: Nylon 66, UL94V-0 (White)  
GWT: Nylon 66, UL94V-0, GWT 750°C
3. Finish:  
(blank): Tin over Nickel  
G: Gold over Nickel

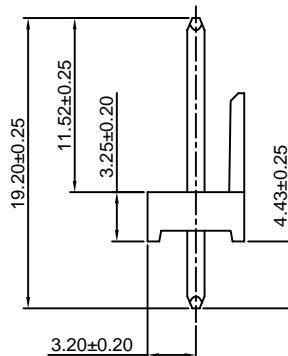
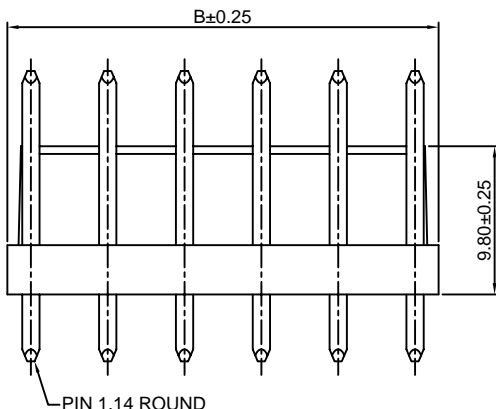
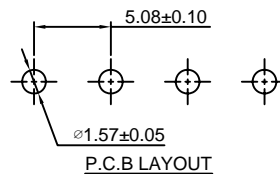
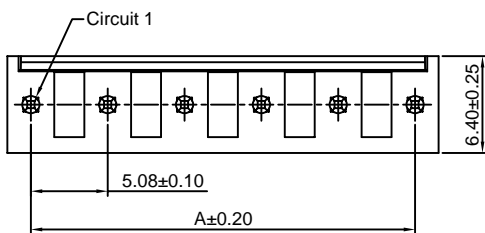
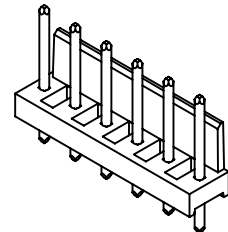

**Ordering Information & Dimensions:**

PART NO.	Dimensions	
	A	B
2P	5.08	8.20
3P	10.16	13.28
4P	15.24	18.36
5P	20.32	23.44
6P	25.40	28.52
7P	30.48	33.60
8P	35.56	38.68
9P	40.64	43.76
10P	45.72	48.84
11P	50.80	53.92
12P	55.88	59.00
13P	60.96	64.08
14P	66.04	69.16
15P	71.12	74.24
16P	76.20	79.32
17P	81.28	84.40
18P	86.36	89.48
19P	91.44	94.56
20P	96.52	99.64

Unit: mm

### A5081WV-XP-R

5.08mm pitch 180° Wafer Round Pin

#### Reference Informations:

- \*Material:Pin:Brass/Tin over Nickel  
Insulator:Nylon 66,UL94V-2
- \*Mates with CJT A5081H-XP,A5082H-XP,  
A5082H-XP-A series Housing
- \*Color:Natural

#### Ordering Information:

A5081WV-XP-R - \*\*\* - \*\*  
1 2 3

- Part No.
- Material:  
(blank):Nylon 66,UL94V-2(Natural)  
V0:Nylon 66,UL94V-0(White)  
GWT:Nylon 66,UL94V-0,GWT 750°C
- Finish:  
(blank):Tin over Nickel  
G:Gold over Nickel

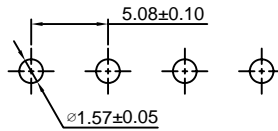
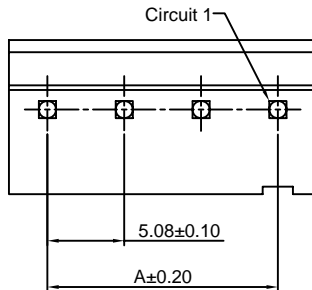
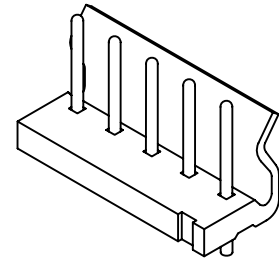

P.C.B LAYOUT

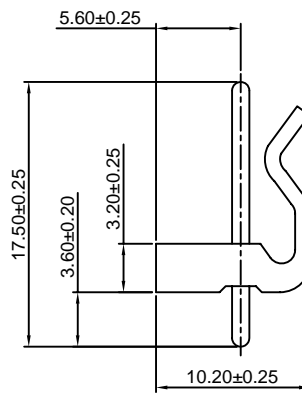
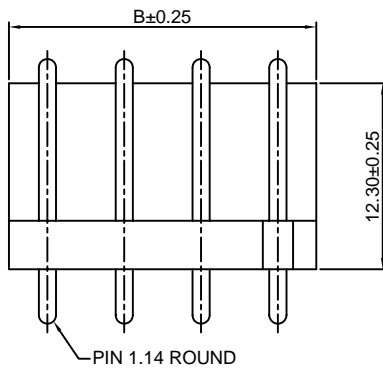

#### Ordering Information & Dimensions:

PART NO.	Dimensions	
	A	B
2P	5.08	10.16
3P	10.16	15.24
4P	15.24	20.32
5P	20.32	25.40
6P	25.40	30.48
7P	30.48	35.56
8P	35.56	40.64
9P	40.64	45.72
10P	45.72	50.80
11P	50.80	55.88
12P	55.88	60.96
13P	60.96	66.04
14P	66.04	71.12
15P	71.12	76.20
16P	76.20	81.28
17P	81.28	86.36
18P	86.36	91.44
19P	91.44	96.52
20P	96.52	101.60

Unit: mm

### A5081WVA-XP-R

5.08mm pitch 180° Wafer Round Pin

#### Reference Informations:

- \*Material:Pin:Brass/Tin over Nickel  
Insulator:Nylon 66,UL94V-2
- \*Mates with CJT A5081H-XP,A5082H-XP,  
A5082H-XP-A series Housing
- \*Color:Natural

#### Ordering Information:

A5081WVA-XP-R - \*\*\* - \*\*  
1 2 3

- Part No.
- Material:  
(blank):Nylon 66,UL94V-2(Natural)  
V0:Nylon 66,UL94V-0(White)  
GWT:Nylon 66,UL94V-0,GWT 750°C
- Finish:  
(blank):Tin over Nickel  
G:Gold over Nickel

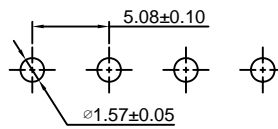
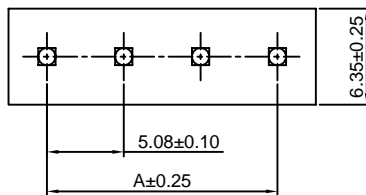
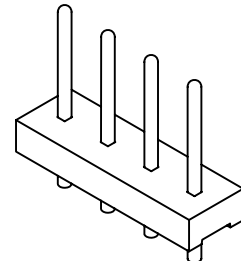

P.C.B LAYOUT

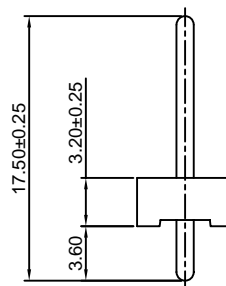
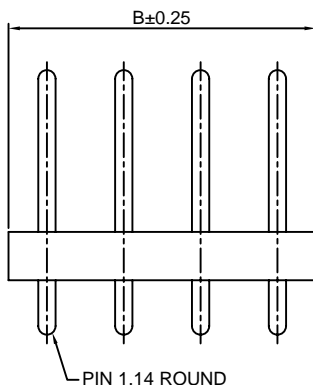

#### Ordering Information & Dimensions:

PART NO.	Dimensions	
	A	B
2P	5.08	10.16
3P	10.16	15.24
4P	15.24	20.32
5P	20.32	25.40
6P	25.40	30.48
7P	30.48	35.56
8P	35.56	40.64
9P	40.64	45.72
10P	45.72	50.80
11P	50.80	55.88
12P	55.88	60.96
13P	60.96	66.04
14P	66.04	71.12
15P	71.12	76.20
16P	76.20	81.28
17P	81.28	86.36
18P	86.36	91.44
19P	91.44	96.52
20P	96.52	101.60

Unit: mm

### A5081WV-XP-A

10.16mm pitch 180° Wafer

#### Reference Informations:

- \*Material: Pin: Brass/Tin over Nickel  
Insulator: Nylon 66, UL94V-2
- \*Mates with CJT A5081H-XP, A5082H-XP, A5082H-XP-A series Housing
- \*Color: Natural

#### Ordering Information:

- A5081WV-XP-A - \*\*\* - \*\***  
 $\frac{1}{2} \frac{3}{3}$
1. Part No.
  2. Material:  
(blank): Nylon 66, UL94V-2 (Natural)  
V0: Nylon 66, UL94V-0 (White)  
GWT: Nylon 66, UL94V-0, GWT 750°C
  3. Finish:  
(blank): Tin over Nickel  
G: Gold over Nickel

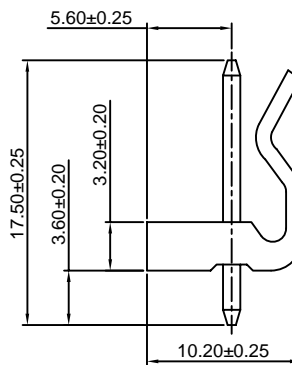
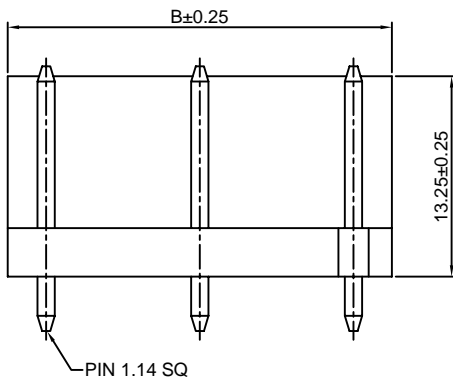
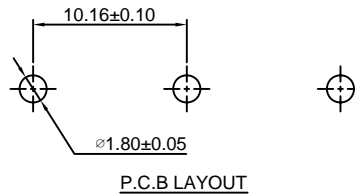
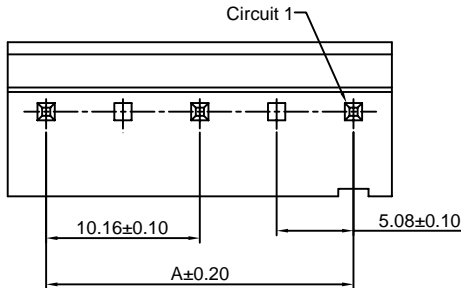
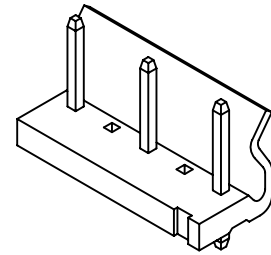

#### Ordering Information & Dimensions:

PART NO.	Dimensions	
	A	B
3P	10.16	15.24
5P	20.32	25.40
7P	30.48	35.56
9P	40.64	45.72
11P	50.80	55.88
13P	60.96	66.04
15P	71.12	76.20
17P	81.28	86.36
19P	91.44	96.52

Unit: mm

### A5081WR-XP-A

10.16mm pitch 90° Wafer

#### Reference Informations:

- \*Material: Pin: Brass/Tin over Nickel  
Insulator: Nylon 66, UL94V-2
- \*Mates with CJT A5081H-XP, A5082H-XP, A5082H-XP-A series Housing
- \*Color: Natural

#### Ordering Information:

- A5081WR-XP-A - \*\*\* - \*\***  
 $\frac{1}{2} \frac{3}{3}$
1. Part No.
  2. Material:  
(blank)-Nylon 66, UL94V-2 (Natural)  
V0-Nylon 66, UL94V-0 (White)  
GWT-Nylon 66, UL94V-0, GWT 750°C
  3. Finish:  
(blank): Tin over Nickel  
G: Gold over Nickel

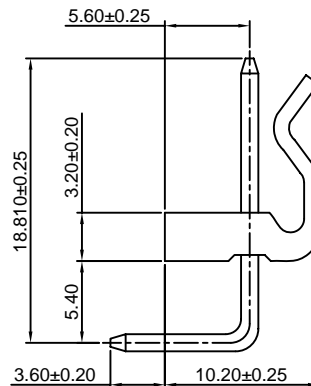
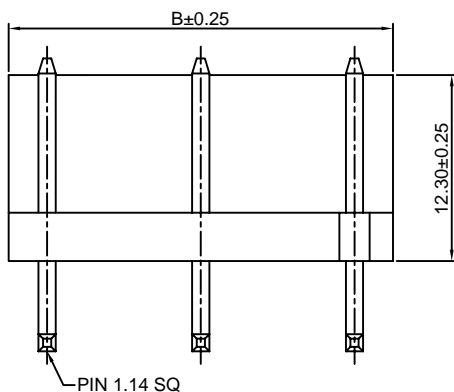
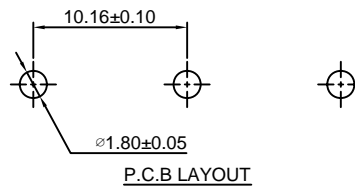
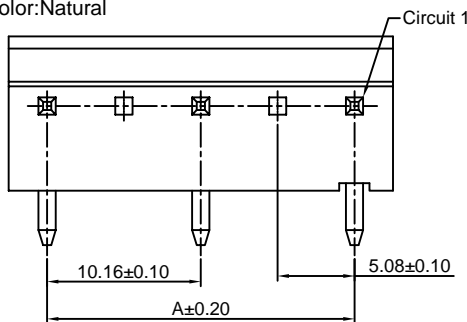
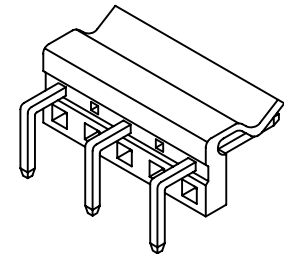

#### Ordering Information & Dimensions:

PART NO.	Dimensions	
	A	B
3P	10.16	15.24
5P	20.32	25.40
7P	30.48	35.56
9P	40.64	45.72
11P	50.80	55.88
13P	60.96	66.04
15P	71.12	76.20
17P	81.28	86.36
19P	91.44	96.52

Unit: mm

## X-ON Electronics

Largest Supplier of Electrical and Electronic Components

*Click to view similar products for [Headers & Wire Housings](#) category:*

*Click to view products by [Changjiang](#) manufacturer:*

Other Similar products are found below :

[95000-104TRLF](#) [10135584-644402LF](#) [DF62W-EP2022PCA](#) [95000-106TRLF](#) [DF62W-2022SCA](#) [DF62W-EP2022PC](#) [2203348](#) [DF62W-2022SC](#) [1084018](#) [1029039](#) [1084017](#) [802-10-012-10-002000](#) [1112640](#) [1112639](#) [891-007-9SS-BST1T](#) [000-34000](#) [0008550134](#) [0009482033](#) [0009507031](#) [57102-F02-18ULF](#) [57102-S06-03LF](#) [57202-S52-04LF](#) [PCN6-15S-2.5E](#) [0039019024](#) [58102-G61-06LF](#) [582553-1](#) [0009485154](#) [0009508121](#) [0022285053](#) [0050291907](#) [018731A](#) [LY20-4P-DT1-P1E-BR](#) [02.125.8002.8](#) [60101931](#) [60598-1 \(Cut Strip\)](#) [M1625-3R/100](#) [61062-3](#) [61082-181009](#) [CSU011177004](#) [636-1427](#) [638009-1](#) [641938-9](#) [641991-4](#) [644168-1](#) [644827-2](#) [647662-1](#) [65039-019ELF](#) [65692-001LF](#) [65781-018](#) [65781-047](#)