

## Specifications

- Current rating:10A AC,DC(AWG #16)
- Voltage rating:250V AC,DC
- Temperature range:-40°C~+105°C
- Contact resistance:10mΩMax.
- Insulation resistance:1000MΩMin.
- Withstanding voltage:1500V AC/minute
- \*Compliant with RoHS and REACH\*
- \*Meet the HF/Halogen Free,GWT/Glow wire Test (IEC60335-1) request,need to customize\*
- \*Contact CJT for details\*

## Standards

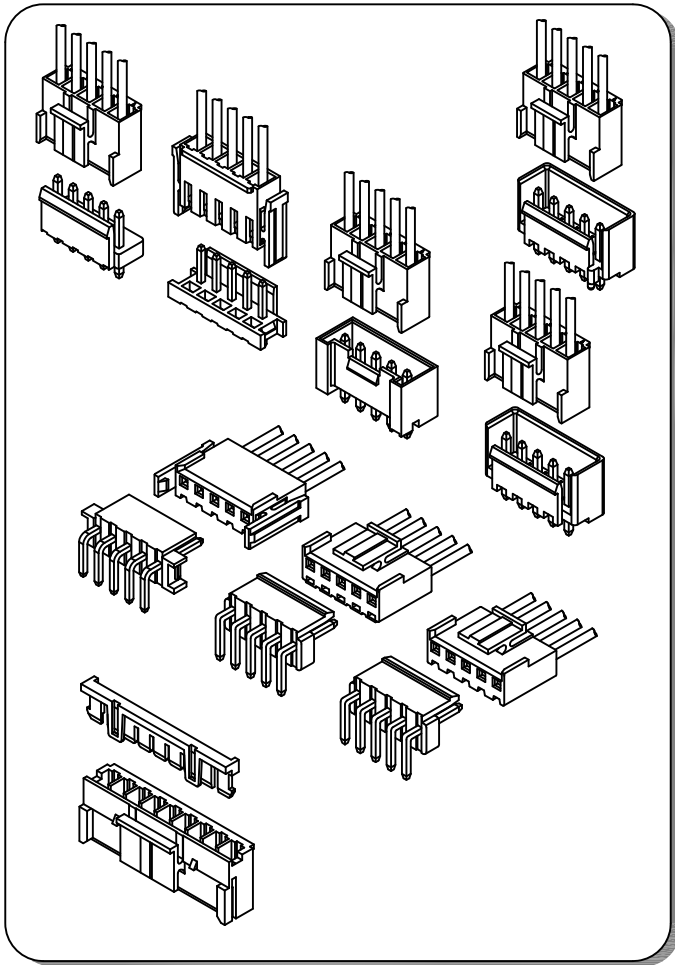

## Assembly layout

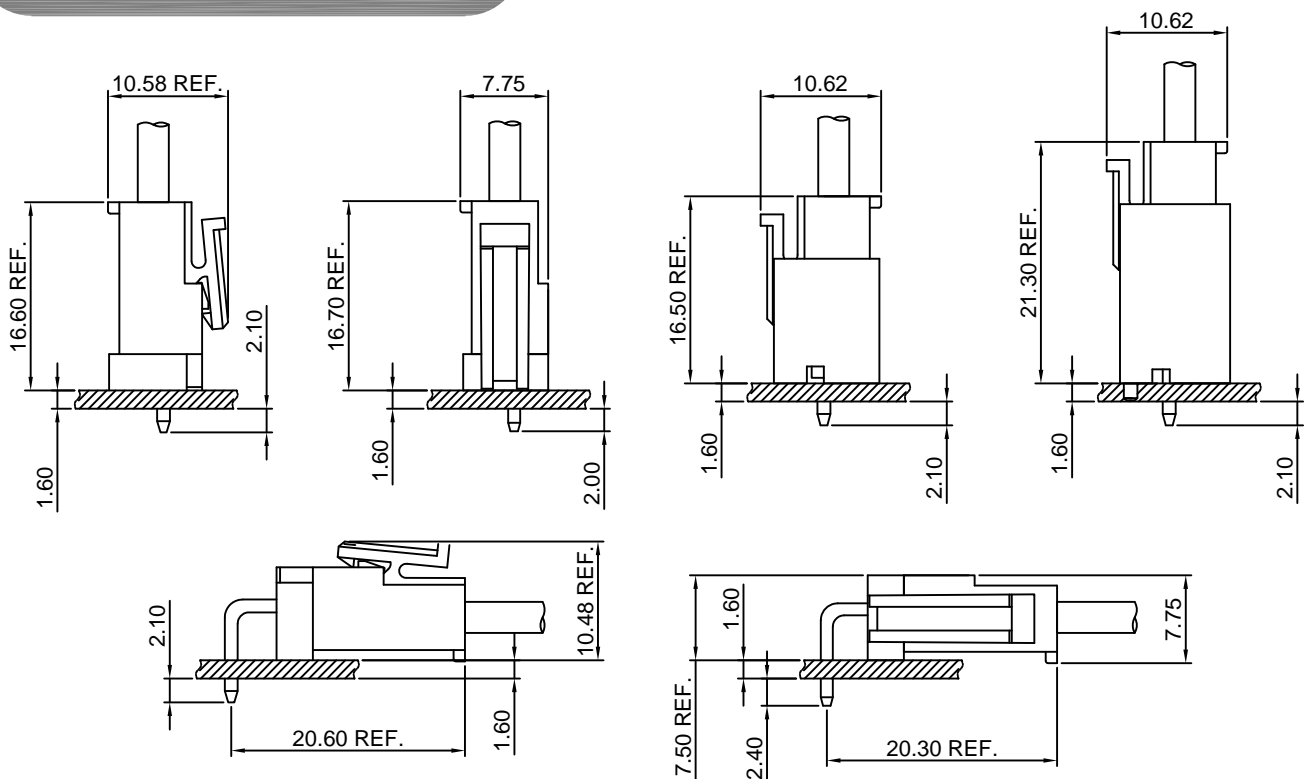

### A3963-T

3.96mm pitch Crimp Terminal

**Reference Informations:**

\*Used in CJT A3963H,HA,HB,HC-XP,A5001H,HA-XP,A7921H-2P series Housing

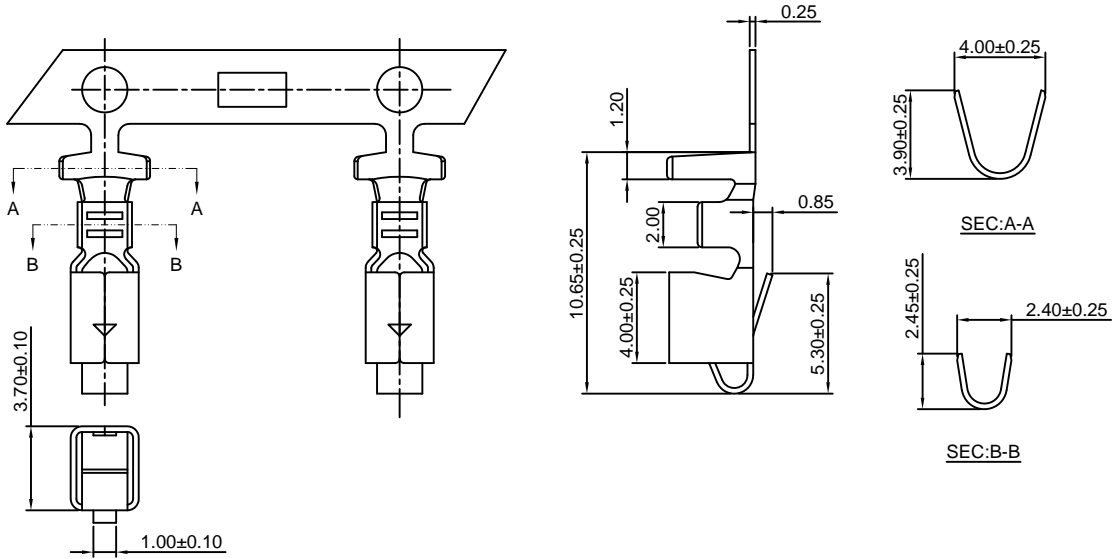

**Ordering information & Specifications:**

Unit:mm

Part NO.	Wire Range	Insulation O.D.	Material	Finish	Qty/reel
A3963-TB	AWG#18-#22	3.00mm(max)	Brass	Tin over Nickel	4,000 PCS
A3963-TP	AWG#18-#22	3.00mm(max)	Phosphor Bronze	Tin over Nickel	4,000 PCS
A3963-GB	AWG#18-#22	3.00mm(max)	Brass	Gold over Nickel	4,000 PCS
A3963-GP	AWG#18-#22	3.00mm(max)	Phosphor Bronze	Gold over Nickel	4,000 PCS

Optional Gold plating available but MOQ requested

### A3963-T-H

3.96mm pitch Crimp Terminal

**Reference Informations:**

\*Used in CJT A3963H,HA,HB,HC-XP,A5001H,HA-XP,A7921H-2P series Housing

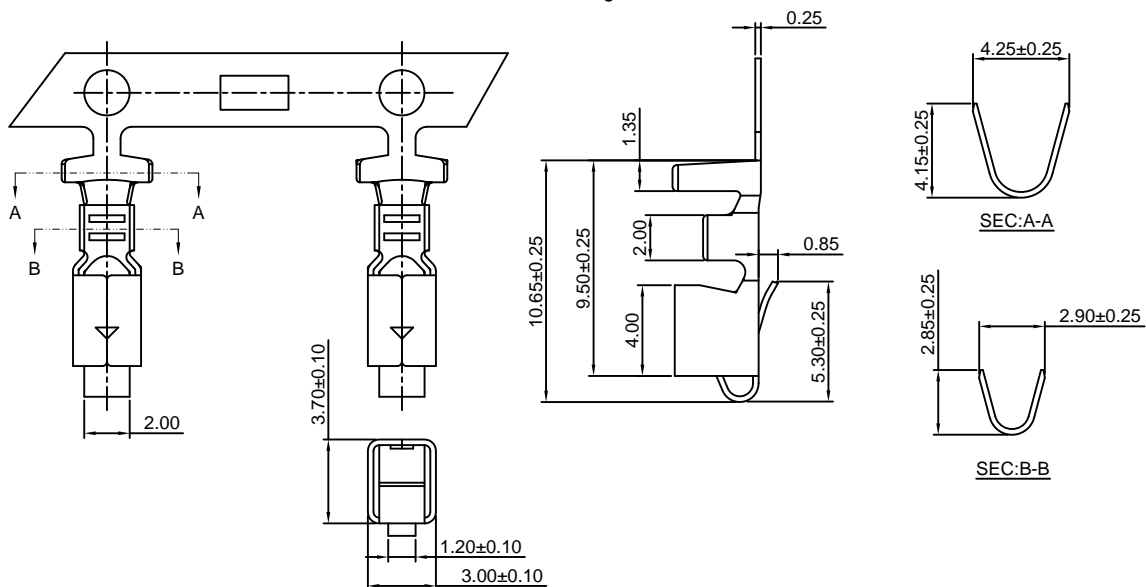

**Ordering information & Specifications:**

Unit:mm

Part NO.	Wire Range	Insulation O.D.	Material	Finish	Qty/reel
A3963-TB-H	AWG#16-#20	3.40mm(max)	Brass	Tin over Nickel	4,000 PCS
A3963-TP-H	AWG#16-#20	3.40mm(max)	Phosphor Bronze	Tin over Nickel	4,000 PCS
A3963-GB-H	AWG#16-#20	3.40mm(max)	Brass	Gold over Nickel	4,000 PCS
A3963-GP-H	AWG#16-#20	3.40mm(max)	Phosphor Bronze	Gold over Nickel	4,000 PCS

Optional Gold plating available but MOQ requested

### A3963M-T

3.96mm pitch Crimp Terminal

**Reference Informations:**

\*Used in CJT A3963HM-XP series Housing

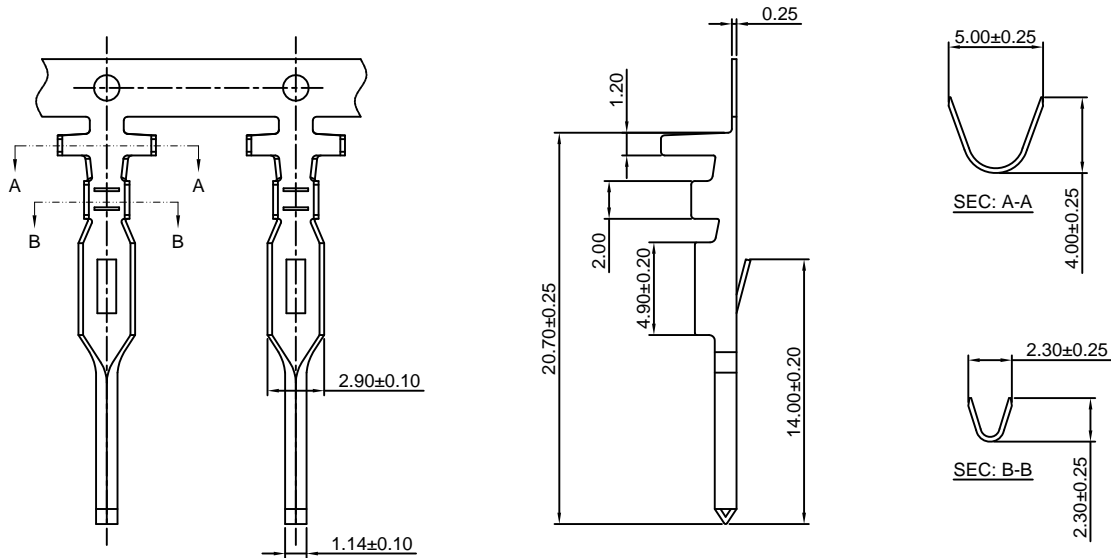

Ordering information & Specifications:

Unit:mm

Part NO.	Wire Range	Insulation O.D.	Material	Finish	Qty/reel
A3963M-TB	AWG#18-#22	3.00mm(max)	Brass	Tin over Nickel	4,000 PCS
A3963M-TP	AWG#18-#22	3.00mm(max)	Phosphor Bronze	Tin over Nickel	4,000 PCS
A3963M-GB	AWG#18-#22	3.00mm(max)	Brass	Gold over Nickel	4,000 PCS
A3963M-GP	AWG#18-#22	3.00mm(max)	Phosphor Bronze	Gold over Nickel	4,000 PCS

Optional Gold plating available but MOQ requested

### A3963H-XP

3.96mm pitch Housing

**Reference Informations:**

\*Material:Nylon 66,UL94V-0

\*Suitable CJT A3963-T(-H) series Terminal

\*Mates with CJT A3963WV,WR-XP(-A),A3963WVD,WRD-XP(-A),

A3963WVD-F-XP(-A),A3963WVD-F-XP-H(-A),

A3963WVD-S,WRD-S-XP(-A),A3963WRH-XP(-A),A7921WR-F-2P

Wafer or CJT A3963HM,HMA-XP Housing

\*Color:White

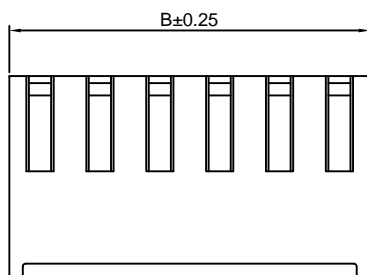
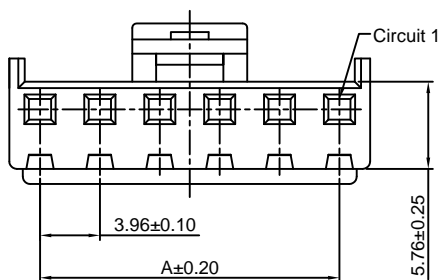
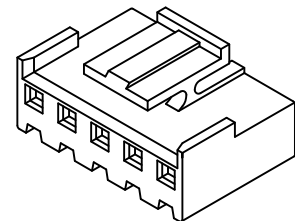

Ordering Information:

A3963H-XP - \*\*\* - \*\*  
1 2 3

1.Part No.

2.Material:

(blank):Nylon 66,UL94V-0

GWT:Nylon 66,UL94V-0,GWT 750°C

3.Color:

(Blank):White

BK:Black

BL:Blue

OR:Orange

PK:Pink

RD:Red

GN:Green

YL:Yellow

GY:Gray

Ordering Information & Dimensions:

PART NO.	Dimensions	
	A	B
2P	3.96	8.02
3P	7.92	11.98
4P	11.88	15.94
5P	15.84	19.90
6P	19.80	23.86
7P	23.76	27.82
8P	27.72	31.78
9P	31.68	35.74
10P	35.64	39.70
11P	39.60	43.66
12P	43.56	47.62
13P	47.52	51.58
14P	51.48	55.54
15P	55.44	59.50

Unit: mm

### A3963HA-XP

3.96mm pitch Housing

**Reference Informations:**

- \*Material:Nylon 66,UL94V-0
- \*Suitable CJT A3963-T(-H) series Terminal
- \*Mates with CJT A3963WV,WR-XP(-A),A3963WVD,WRD-XP(-A),A3963WVD-F-XP(-A),A3963WVD-F-XP-H(-A),A3963WVD-S,WRD-S-XP(-A),A3963WRH-XP(-A) series Wafer
- \*Color:White

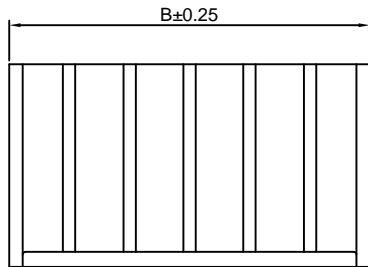
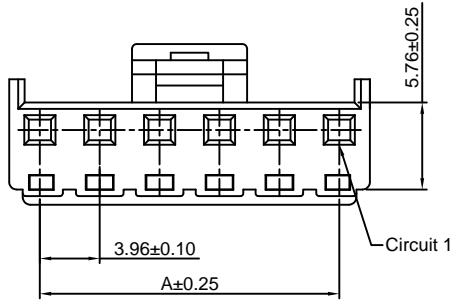

Ordering Information:  
A3963HA-XP - \*\*\* - \*\*  
1 2 3

- 1.Part No.
- 2.Material:  
(blank):Nylon 66,UL94V-0  
GWT:Nylon 66,UL94V-0,GWT 750°C
- 3.Color:  
(Blank):White  
BK:Black      RD:Red  
BL:Blue      GN:Green  
OR:Orange    YL:Yellow  
PK:Pink      GY:Gray

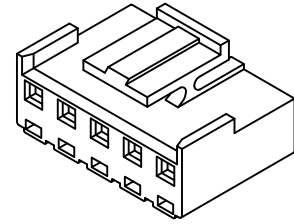

**Ordering Information & Dimensions:**

PART NO.	Dimensions	
	A	B
2P	3.96	8.02
3P	7.92	11.98
4P	11.88	15.94
5P	15.84	19.90
6P	19.80	23.86
7P	23.76	27.82
8P	27.72	31.78
9P	31.68	35.74
10P	35.64	39.70
11P	39.60	43.66
12P	43.56	47.62
13P	47.52	51.58
14P	51.48	55.54
15P	55.44	59.50

Unit: mm

### A3963HB-XP

3.96mm pitch Housing

**Reference Informations:**

- \*Material:Nylon 66,UL94V-0
- \*Suitable CJT A3963-T(-H) series Terminal
- \*Mates with CJT A3963WVB,WRB-XP(-A) series Wafer
- \*Color:White

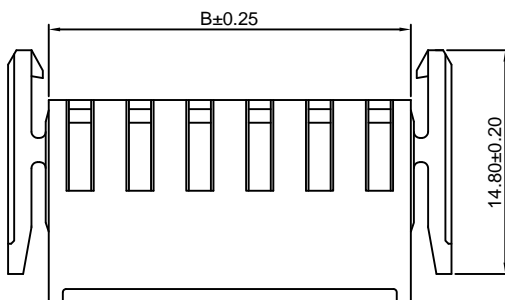
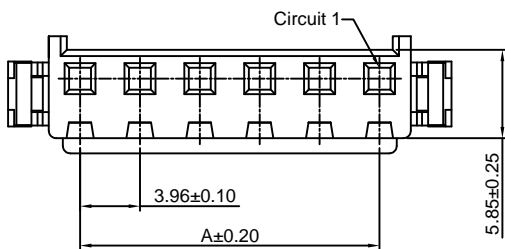

Ordering Information:  
A3963HB-XP - \*\*\*  
1 2

- 1.Part No.
- 2.Material:  
(blank):Nylon 66,UL94V-0  
GWT:Nylon 66,UL94V-0,GWT 750°C

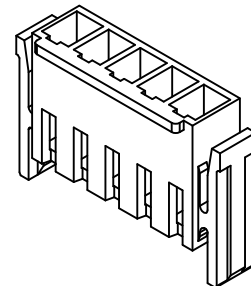

**Ordering Information & Dimensions:**

PART NO.	Dimensions	
	A	B
2P	3.96	8.10
3P	7.92	12.06
4P	11.88	16.02
5P	15.84	19.98
6P	19.80	23.94
7P	23.76	27.90
8P	27.72	31.86
9P	31.68	35.82
10P	35.64	39.78
11P	39.60	43.74
12P	43.56	47.70
13P	47.52	51.66
14P	51.48	55.62
15P	55.44	59.58

Unit: mm

## A3963HC-XP

3.96mm pitch Housing

**Reference Informations:**

- \*Material:Nylon 66,UL94V-0
- \*Suitable CJT A3963-T(-H) series Terminal
- \*Mates with CJT A3963S-XP series Interface Seal,
- A3963WV,WR-XP(-A),A3963WRH-XP(-A) series Wafer
- \*Color:White

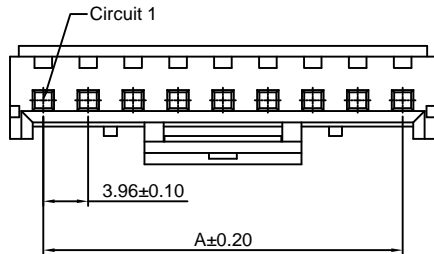

**Ordering Information:**

A3963HC-XP - \*\*\*  
1 2

- 1.Part No.
- 2.Material:  
(blank):Nylon 66,UL94V-0  
GWT:Nylon 66,UL94V-0,GWT 750°C

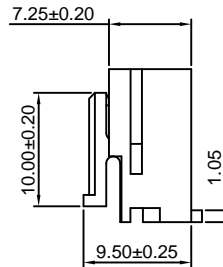
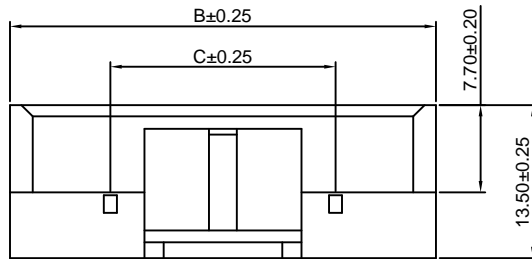
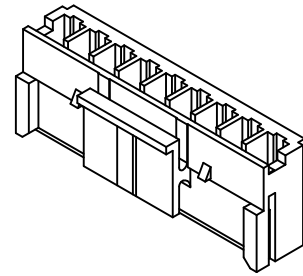

**Ordering Information & Dimensions:**

PART NO.	Dimensions		
	A	B	C
2P	3.96	9.63	----
3P	7.92	13.59	----
4P	11.88	17.55	----
5P	15.84	21.51	----
6P	19.80	25.47	----
7P	23.76	29.43	19.80
8P	27.72	33.39	19.80
9P	31.68	37.35	19.80
10P	35.64	41.31	19.80
11P	39.60	45.27	27.72
12P	43.56	49.23	27.72
13P	47.52	53.19	27.72
14P	51.48	57.15	27.72
15P	55.44	61.11	27.72

Unit: mm

## A3963S-XP

3.96mm pitch Interface Seal

**Reference Informations:**

- \*Material:Insulator:Nylon 66,UL94V-0
- \*Mates with CJT A3963HC-XP series Housing
- \*Color:Red

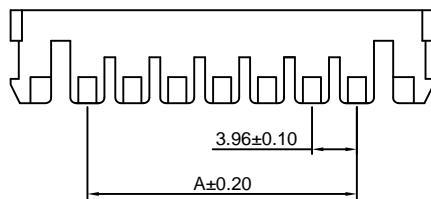

**Ordering Information:**

A3963S-XP - \*\*\*  
1 2

- 1.Part No.
- 2.Material:  
(blank):Nylon 66,UL94V-0  
GWT:Nylon 66,UL94V-0,GWT 750°C

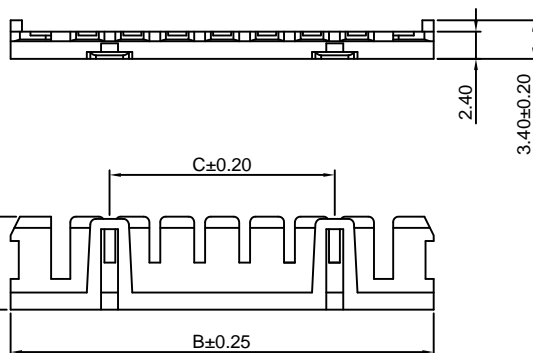
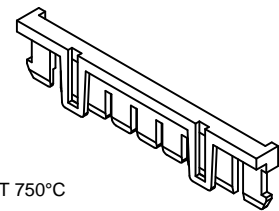

**Ordering Information & Dimensions:**

PART NO.	Dimensions		
	A	B	C
2P	----	9.58	----
3P	----	13.54	----
4P	3.96	17.50	----
5P	7.92	21.46	----
6P	11.88	25.42	----
7P	15.84	29.38	19.80
8P	19.80	33.34	19.80
9P	23.76	37.30	19.80
10P	27.72	41.26	19.80
11P	31.68	45.22	27.72
12P	35.64	49.18	27.72
13P	39.60	53.14	27.72
14P	43.56	57.10	27.72
15P	47.52	61.06	27.72

Unit: mm

### A3963HM(A)-XP

3.96mm pitch Housing

#### Reference Informations:

- \*Material: Nylon 66, UL94V-0
- \*Suitable CJT A3963M-T series Terminal
- \*Mates with CJT A3963H-XP series Housing
- \*Color: White

#### Ordering Information:

- A3963HM(A)-XP - <sup>\*\*</sup>/<sub>2</sub> - <sup>\*\*</sup>/<sub>3</sub>
- Part No.
  - Color:  
(Blank): White  
RD: Red  
YL: Yellow  
BL: Blue  
BK: Black  
GN: Green
  - Material:  
(Blank): Nylon 66, UL94V-0  
GWT: Nylon 66, UL94V-0, GWT 750°C

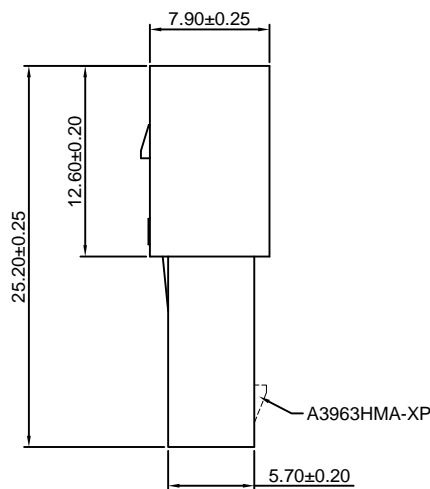
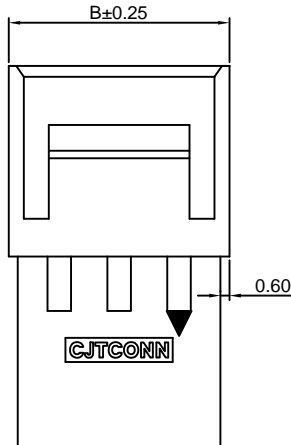
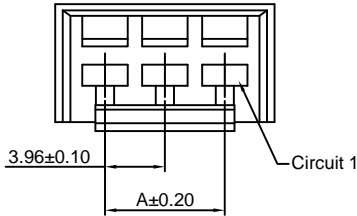
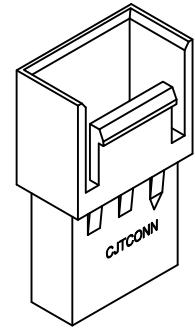

#### Ordering Information & Dimensions:

PART NO.	Dimensions	
	A	B
2P	3.96	10.64
3P	7.92	14.60
4P	11.88	18.56
5P	15.84	22.52
6P	19.80	26.48
7P	23.76	30.44
8P	27.72	34.40
9P	31.68	38.36
10P	35.64	42.32
11P	39.60	46.28
12P	43.56	50.24
13P	47.52	54.20
14P	51.48	58.16
15P	55.44	62.12

Unit: mm

### A3963WV(-F1)-XP

3.96mm pitch 180° Wafer

#### Reference Informations:

- \*Material: Pin: Brass/Tin over Nickel  
Insulator: Nylon 66, UL94V-0
- \*Mates with CJT A3963H, HA, HC-XP series Housing
- \*Color: White

#### Ordering Information:

- A3963WV(-F1)-XP - <sup>\*\*\*</sup>/<sub>2</sub> - <sup>\*\*</sup>/<sub>3</sub> - <sup>\*\*</sup>/<sub>4</sub>
- Part No.
  - Material:  
(Blank): Nylon 66, UL94V-0  
GWT: Nylon 66, UL94V-0, GWT 750°C
  - Color:  
(Blank): White  
BK: Black  
BL: Blue  
OR: Orange  
PK: Pink  
RD: Red  
GN: Green  
YL: Yellow  
GY: Gray
  - Finish:  
(Blank): Tin over Nickel  
G: Gold over Nickel

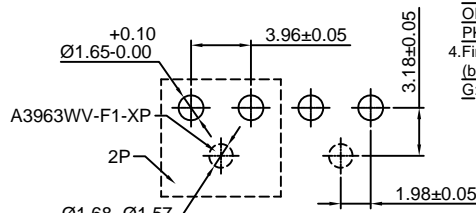
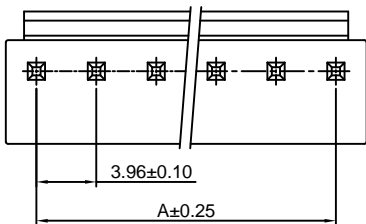
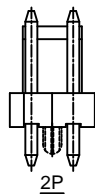
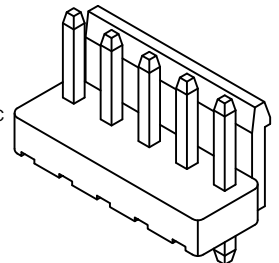

P.C.B LAYOUT

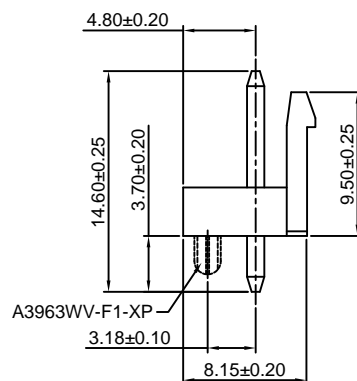
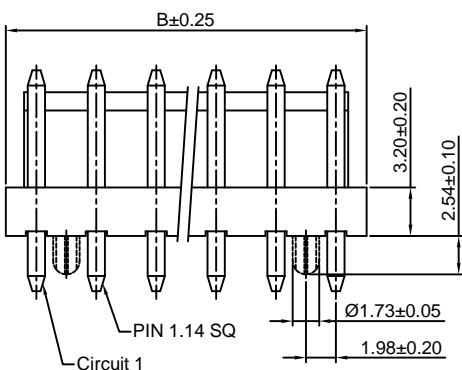

#### Ordering Information & Dimensions:

PART NO.	Dimensions	
	A	B
2P	3.96	7.92
3P	7.92	11.88
4P	11.88	15.84
5P	15.84	19.80
6P	19.80	23.76
7P	23.76	27.72
8P	27.72	31.68
9P	31.68	35.64
10P	35.64	39.60
11P	39.60	43.56
12P	43.56	47.52
13P	47.52	51.48
14P	51.48	55.44
15P	55.44	59.40

Unit: mm

### A3963WR-XP

3.96mm pitch 90° Wafer

#### Reference Informations:

- \*Material: Pin: Brass/Tin over Nickel  
Insulator: Nylon 66, UL94V-0
- \*Mates with CJT A3963H, HA, HC-XP series Housing
- \*Color: White

#### Ordering Information:

A3963WR-XP - \*\*\* - \*\* - \*\*  
1 2 3 4

- Part No.
- Material:  
(blank): Nylon 66, UL94V-0  
GWT: Nylon 66, UL94V-0, GWT 750°C
- Color:  
(Blank): White  
BK: Black RD: Red  
BL: Blue GN: Green  
OR: Orange YL: Yellow  
PK: Pink GY: Gray
- Finish:  
(blank): Tin over Nickel  
G: Gold over Nickel

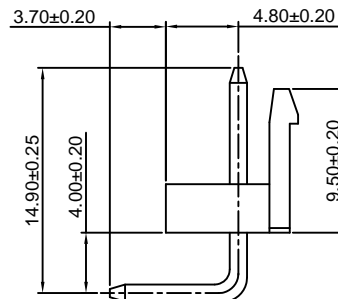
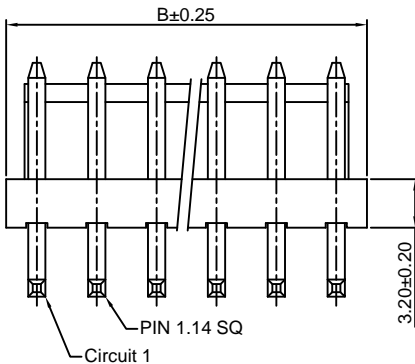
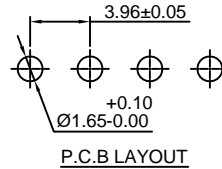
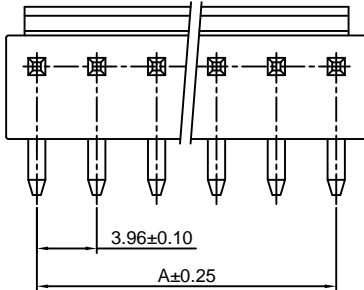
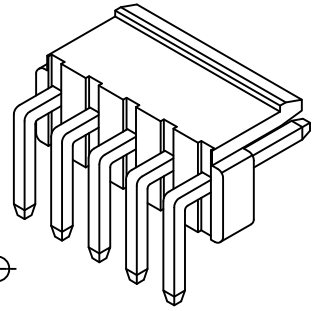

#### Ordering Information & Dimensions:

PART NO.	Dimensions	
	A	B
2P	3.96	7.92
3P	7.92	11.88
4P	11.88	15.84
5P	15.84	19.80
6P	19.80	23.76
7P	23.76	27.72
8P	27.72	31.68
9P	31.68	35.64
10P	35.64	39.60
11P	39.60	43.56
12P	43.56	47.52
13P	47.52	51.48
14P	51.48	55.44
15P	55.44	59.40

Unit: mm

### A3963WVB-XP

3.96mm pitch 180° Wafer

#### Reference Informations:

- \*Material: Pin: Brass/Tin over Nickel  
Insulator: Nylon 66, UL94V-0
- \*Mates with CJT A3963HB-XP series Housing
- \*Color: White

#### Ordering Information:

A3963WVB-XP - \*\*\* - \*\*  
1 2 3

- Part No.
- Material:  
(blank): Nylon 66, UL94V-0  
GWT: Nylon 66, UL94V-0, GWT 750°C
- Finish:  
(blank): Tin over Nickel  
G: Gold over Nickel

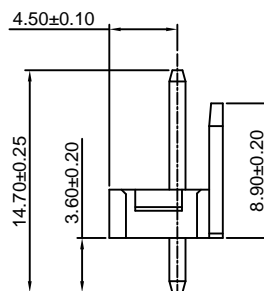
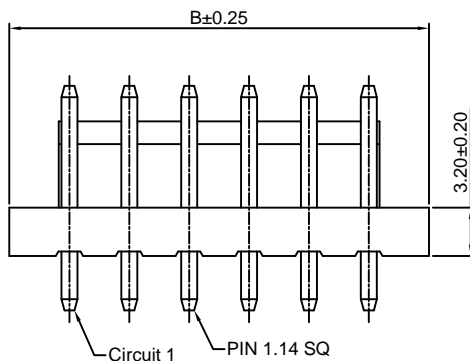
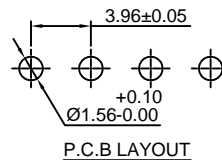
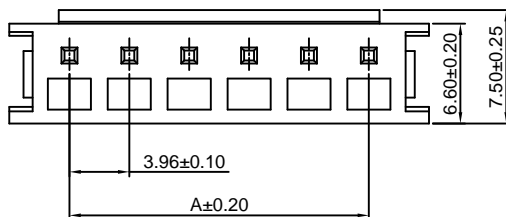
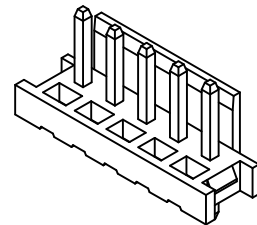

#### Ordering Information & Dimensions:

PART NO.	Dimensions	
	A	B
2P	3.96	11.92
3P	7.92	15.88
4P	11.88	19.84
5P	15.84	23.80
6P	19.80	27.76
7P	23.76	31.72
8P	27.72	35.68
9P	31.68	39.64
10P	35.64	43.60
11P	39.60	47.56
12P	43.56	51.52
13P	47.52	55.48
14P	51.48	59.44
15P	55.44	63.40

Unit: mm

### A3963WRB-XP

3.96mm pitch 90° Wafer

#### Reference Informations:

- \*Material: Pin: Brass/Tin over Nickel  
Insulator: Nylon 66, UL94V-0
- \*Mates with CJT A3963HB-XP series Housing
- \*Color: Beige

#### Ordering Information:

A3963WRB-XP - \*\*\* - \*\*  
1 2 3

- Part No.
- Material:  
(blank): Nylon 66, UL94V-0  
GWT: Nylon 66, UL94V-0, GWT 750°C
- Finish:  
(blank): Tin over Nickel  
G: Gold over Nickel

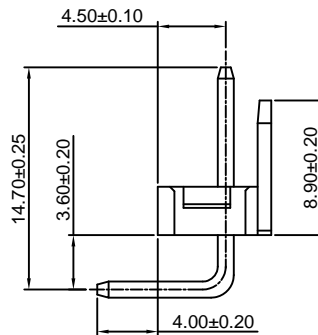
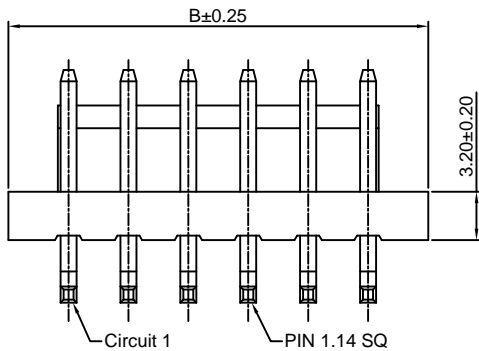
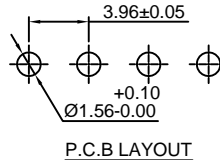
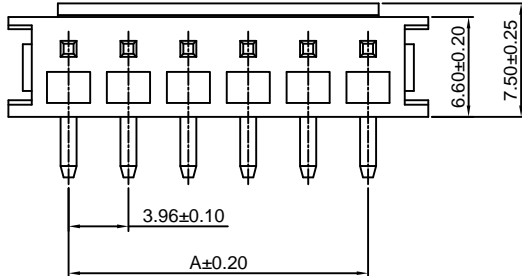
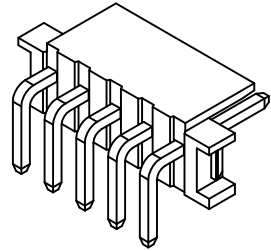

#### Ordering Information & Dimensions:

PART NO.	Dimensions	
	A	B
2P	3.96	11.92
3P	7.92	15.88
4P	11.88	19.84
5P	15.84	23.80
6P	19.80	27.76
7P	23.76	31.72
8P	27.72	35.68
9P	31.68	39.64
10P	35.64	43.60
11P	39.60	47.56
12P	43.56	51.52
13P	47.52	55.48
14P	51.48	59.44
15P	55.44	63.40

Unit: mm

### A3963WVD-F-XP

3.96mm pitch 180° Wafer

#### Reference Informations:

- \*Material: Pin: Brass/Tin over Nickel  
Insulator: PBT+30%GF, UL94V-0
- \*Mates with CJT A3963H, HA-XP series Housing
- \*Color: White

#### Ordering Information:

A3963WVD-F-XP - \*\*\* - \*\* - \*\*  
1 2 3 4

- Part No.
- Material:  
(blank): PBT+30%GF, UL94V-0  
GWT: PBT, UL94V-0, GWT 750°C
- Color:  
(Blank): White  
BK: Black RD: Red  
BL: Blue GN: Green  
OR: Orange YL: Yellow  
PK: Pink GY: Gray
- Finish:  
(blank): Tin over Nickel  
G: Gold over Nickel

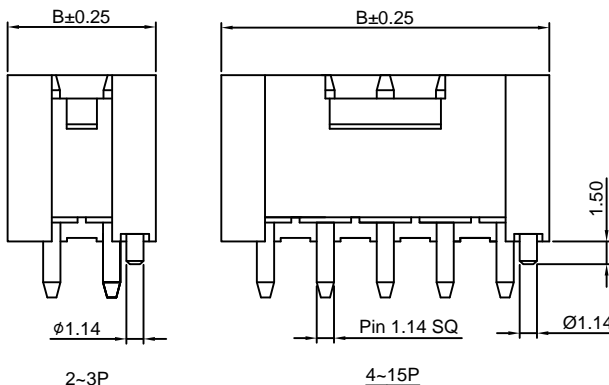
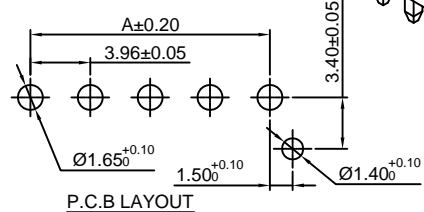
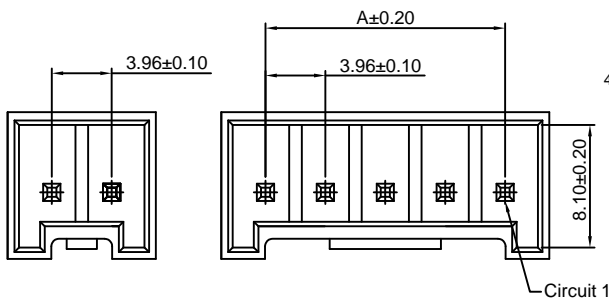
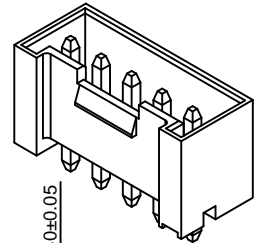

#### Ordering Information & Dimensions:

PART NO.	Dimensions	
	A	B
2P	3.96	9.80
3P	7.92	13.76
4P	11.88	17.72
5P	15.84	21.68
6P	19.80	25.64
7P	23.76	29.60
8P	27.72	33.56
9P	31.68	37.52
10P	35.64	41.48
11P	39.60	45.44
12P	43.56	49.40
13P	47.52	53.36
14P	51.48	57.32
15P	55.44	61.28

Unit: mm



### A3963WVD-F1-XP

3.96mm pitch 180° Wafer

**Reference Informations:**

- \*Material: Pin: Brass/Tin over Nickel  
Insulator: PBT, UL94V-0
- \*Mates with CJT A3963H, HA-XP series Housing
- \*Color: White

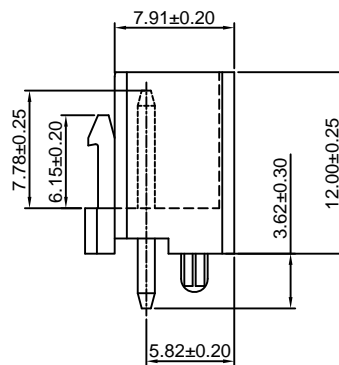
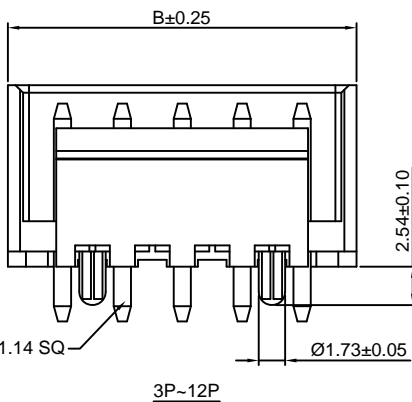
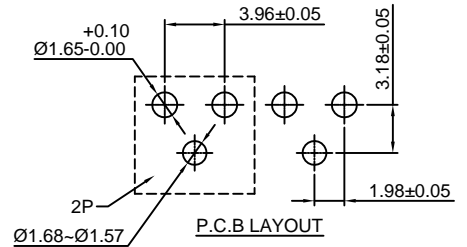
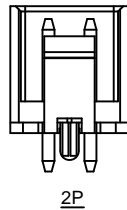
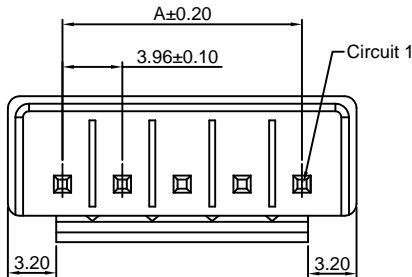
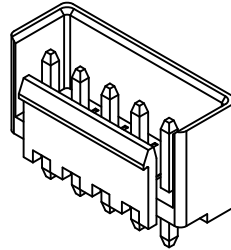

**Ordering Information & Dimensions:**

PART NO.	Dimensions	
	A	B
2P	3.96	11.17
3P	7.92	15.13
4P	11.88	19.09
5P	15.84	23.05
6P	19.80	27.01
7P	23.76	30.97
8P	27.72	34.93
9P	31.68	38.89
10P	35.64	42.85
11P	39.60	46.81
12P	43.56	50.77

Unit: mm

### A3963WVD-FT-XP

3.96mm pitch 180° Wafer

**Reference Informations:**

- \*Material: Pin: Brass/Tin over Nickel  
Insulator: PBT, UL94V-0
- \*Mates with CJT A3963H, HA-XP series Housing
- \*Color: White

Ordering Information:  
A3963WVD-FT-XP - \*\*  
1 2

- 1.Part No.
- 2.Color:  
(blank): White  
BK: Black

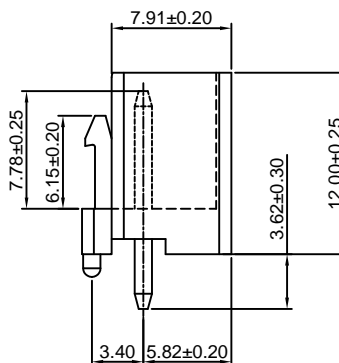
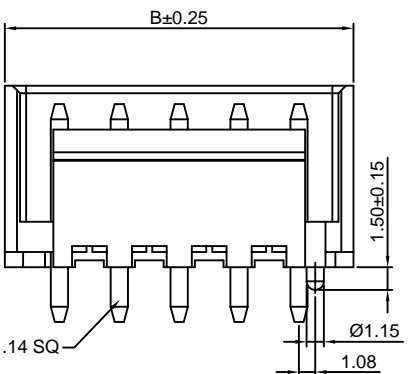
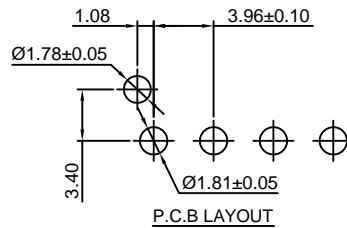
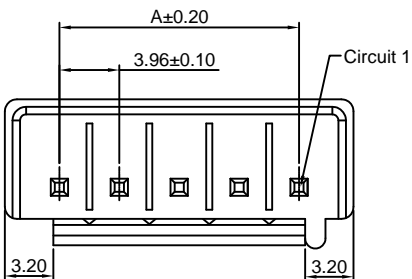
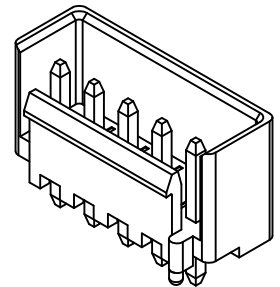

**Ordering Information & Dimensions:**

PART NO.	Dimensions	
	A	B
2P	3.96	11.17
3P	7.92	15.13
4P	11.88	19.09
5P	15.84	23.05
6P	19.80	27.01
7P	23.76	30.97
8P	27.72	34.93
9P	31.68	38.89
10P	35.64	42.85
11P	39.60	46.81
12P	43.56	50.77

Unit: mm

### A3963WRD-XP

3.96mm pitch 90° Wafer

#### Reference Informations:

- \*Material: Pin: Brass/Tin over Nickel  
Insulator: PBT+30%GF, UL94V-0
- \*Mates with CJT A3963H, HA-XP series Housing
- \*Color: White

#### Ordering Information:

A3963WRD-XP - \*\*\* - \*\*  
1 2 3

- Part No.
- Material:  
(blank): PBT+30%GF, UL94V-0  
GWT: PBT, UL94V-0, GWT 750°C
- Finish:  
(blank): Tin over Nickel  
G: Gold over Nickel

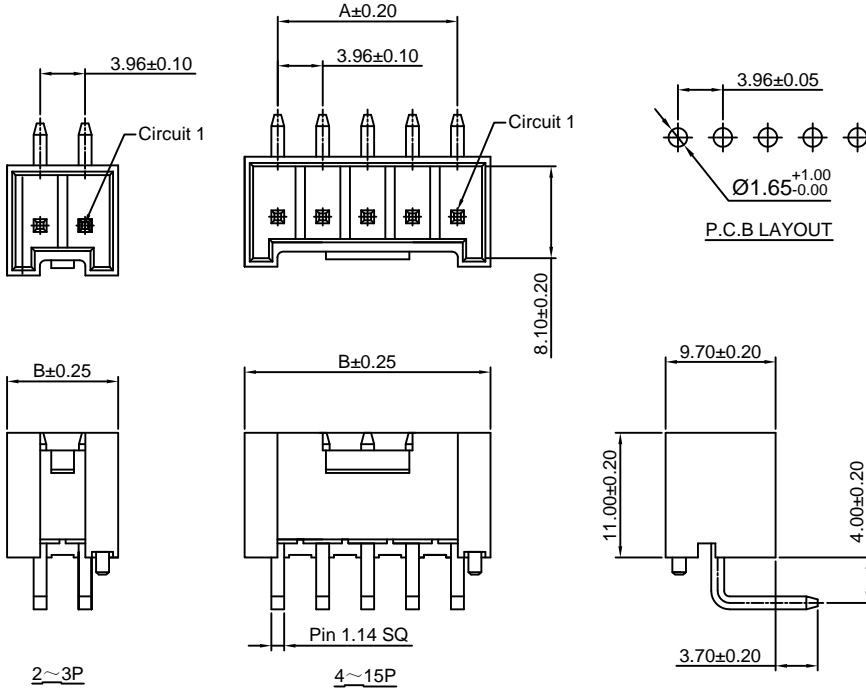

#### Ordering Information & Dimensions:

PART NO.	Dimensions	
	A	B
2P	3.96	9.80
3P	7.92	13.76
4P	11.88	17.72
5P	15.84	21.68
6P	19.80	25.64
7P	23.76	29.60
8P	27.72	33.56
9P	31.68	37.52
10P	35.64	41.48
11P	39.60	45.44
12P	43.56	49.40
13P	47.52	53.36
14P	51.48	57.32
15P	55.44	61.28

Unit: mm

### A3963WRD-XP-A

3.96mm pitch 90° Wafer

#### Reference Informations:

- \*Material: Pin: Brass/Tin over Nickel  
Insulator: PBT+30%GF, UL94V-0
- \*Mates with CJT A3963H, HA-XP series Housing
- \*Color: White

#### Ordering Information:

A3963WRD-XP-A - \*\*\* - \*\*  
1 2 3

- Part No.
- Material:  
(blank): PBT+30%GF, UL94V-0  
GWT: PBT, UL94V-0, GWT 750°C
- Finish:  
(blank): Tin over Nickel  
G: Gold over Nickel

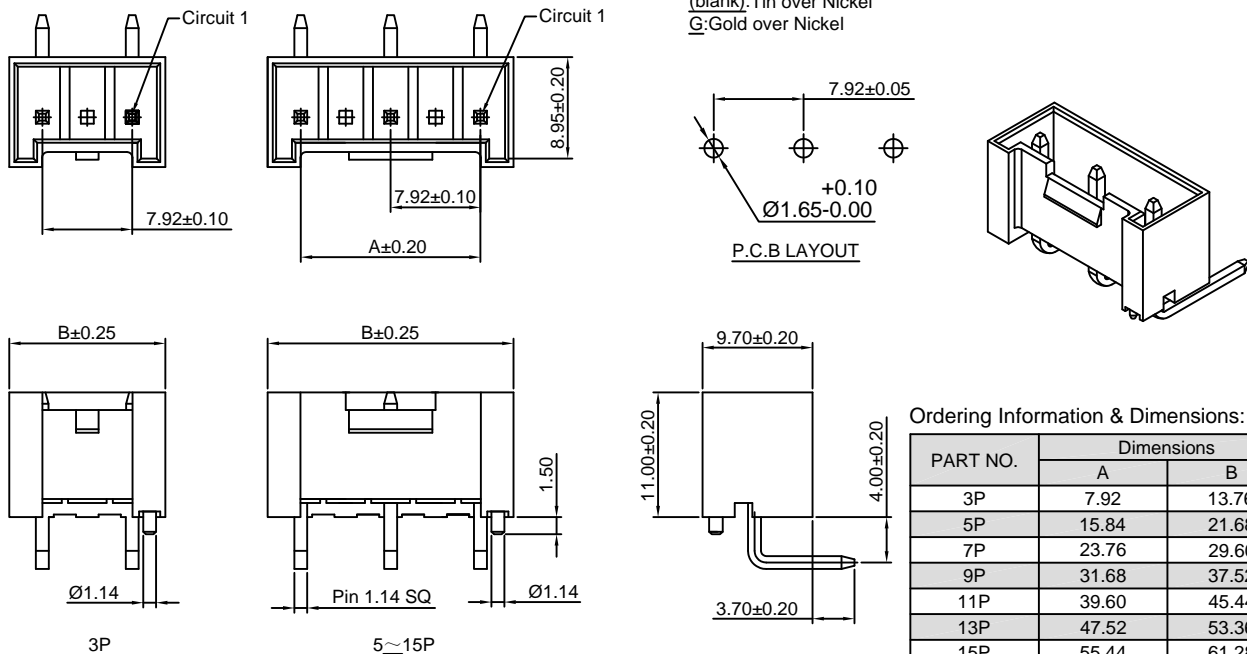

#### Ordering Information & Dimensions:

PART NO.	Dimensions	
	A	B
3P	7.92	13.76
5P	15.84	21.68
7P	23.76	29.60
9P	31.68	37.52
11P	39.60	45.44
13P	47.52	53.36
15P	55.44	61.28

### A3963WVD-S-XP

3.96mm pitch 180° Wafer - SMT TYPE

#### Reference Informations:

- \*Material: Pin: Phosphor Bronze/Tin over Nickel  
Insulator: Nylon 9T, UL94V-0
- \*Mates with CJT A3963H, HA-XP series Housing
- \*Color: Ivory

#### Ordering Information:

- A3963WVD-S-XP - \*\*\* - \*\*  
 1                      2                      3
1. Part No.
  2. Material:  
(blank): Nylon 9T, UL94V-0  
GWT: Nylon 9T, UL94V-0, GWT 750°C
  3. Finish:  
(blank): Tin over Nickel  
G: Gold over Nickel

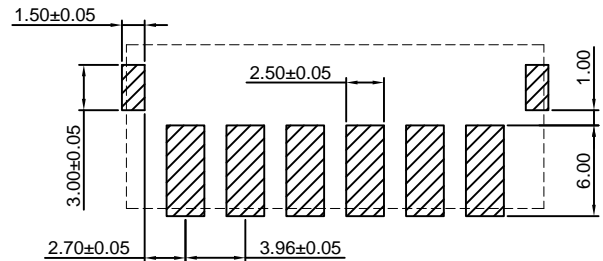
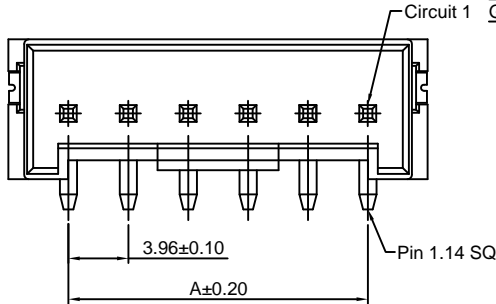

P.C.B LAYOUT

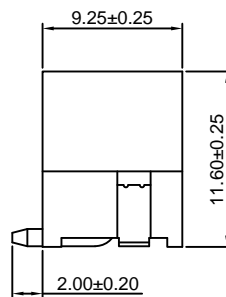
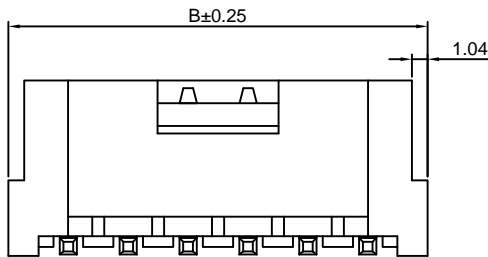

#### Ordering Information & Dimensions:

PART NO.	Dimensions	
	A	B
2P	3.96	11.88
3P	7.92	15.84
4P	11.88	19.80
5P	15.84	23.76
6P	19.80	27.72
7P	23.76	31.68
8P	27.72	35.64
9P	31.68	39.60
10P	35.64	43.56

Unit: mm

### A3963WRD-S-XP

3.96mm pitch 90° Wafer - SMT TYPE

#### Reference Informations:

- \*Material: Pin: Phosphor Bronze/Tin over Nickel  
Insulator: Nylon 9T, UL94V-0
- \*Mates with CJT A3963H, HA-XP series Housing
- \*Color: Ivory

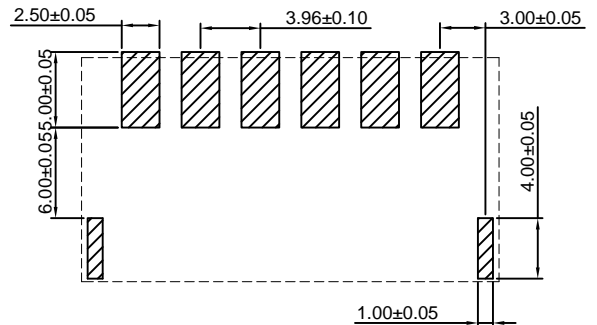

P.C.B LAYOUT

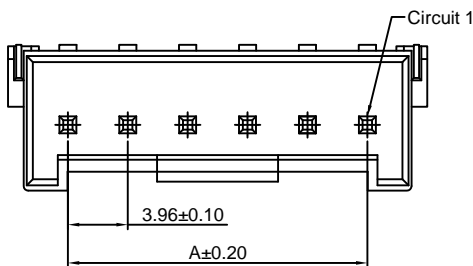

#### Ordering Information:

- A3963WRD-S-XP - \*\*\* - \*\*  
 1                      2                      3
1. Part No.
  2. Material:  
(blank): Nylon 9T, UL94V-0  
GWT: Nylon 9T, UL94V-0, GWT 750°C
  3. Finish:  
(blank): Tin over Nickel  
G: Gold over Nickel

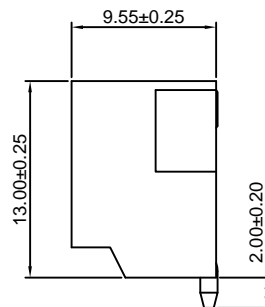
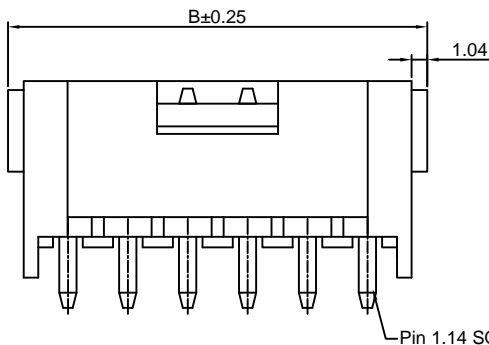

#### Ordering Information & Dimensions:

PART NO.	Dimensions	
	A	B
2P	3.96	11.88
3P	7.92	15.84
4P	11.88	19.80
5P	15.84	23.76
6P	19.80	27.72
7P	23.76	31.68
8P	27.72	35.64
9P	31.68	39.60
10P	35.64	43.56

Unit: mm

### A3963WV-XP-A

7.92mm pitch 180° Wafer

#### Reference Informations:

- \*Material: Pin: Brass/Tin over Nickel  
Insulator: Nylon 66, UL94V-0
- \*Mates with CJT A3963H, HA, HC-XP, A7921H-2P series Housing
- \*Color: White

#### Ordering Information:

A3963WV-XP-A - \*\*\* - \*\* - \*\*  
1 2 3 4

1. Part No.
2. Material:  
(blank): Nylon 66, UL94V-0  
GWT: Nylon 66, UL94V-0, GWT 750°C
3. Color:  
(Blank): White  
BK: Black      RD: Red  
BL: Blue      GN: Green  
OR: Orange    YL: Yellow  
PK: Pink      GY: Gray
4. Finish:  
(blank): Tin over Nickel  
G: Gold over Nickel

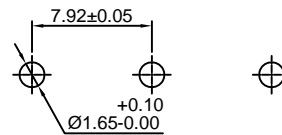
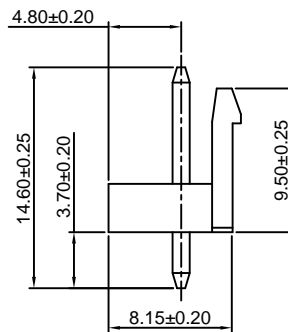
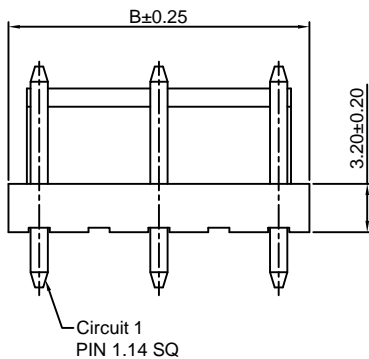
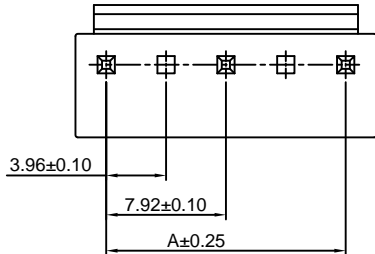
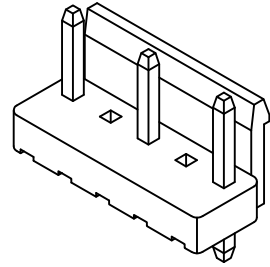

P.C.B LAYOUT

#### Ordering Information & Dimensions:

PART NO.	Dimensions	
	A	B
3P	7.92	11.88
5P	15.84	19.80
7P	23.76	27.72
9P	31.68	35.64
11P	39.60	43.56
13P	47.52	51.48
15P	55.44	59.40

Unit: mm

### A3963WR-XP-A

7.92mm pitch 90° Wafer

#### Reference Informations:

- \*Material: Pin: Brass/Tin over Nickel  
Insulator: Nylon 66, UL94V-0
- \*Mates with CJT A3963H, HA, HC-XP, A7921H-2P series Housing
- \*Color: White

#### Ordering Information:

A3963WR-XP-A - \*\*\* - \*\* - \*\*  
1 2 3 4

1. Part No.
2. Material:  
(blank): Nylon 66, UL94V-0  
GWT: Nylon 66, UL94V-0, GWT 750°C
3. Color:  
(Blank): White  
BK: Black      RD: Red  
BL: Blue      GN: Green  
OR: Orange    YL: Yellow  
PK: Pink      GY: Gray
4. Finish:  
(blank): Tin over Nickel  
G: Gold over Nickel

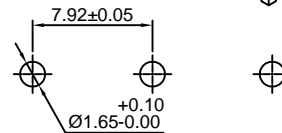
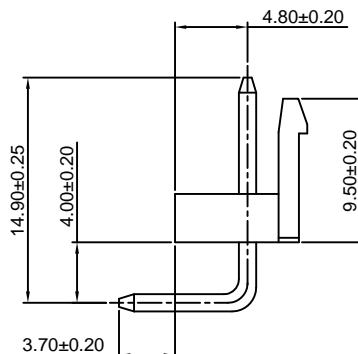
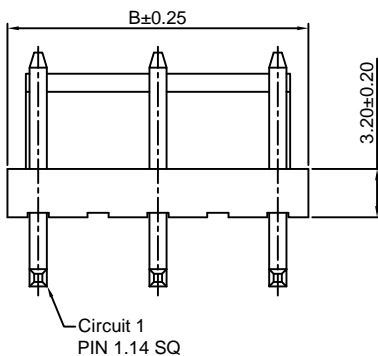
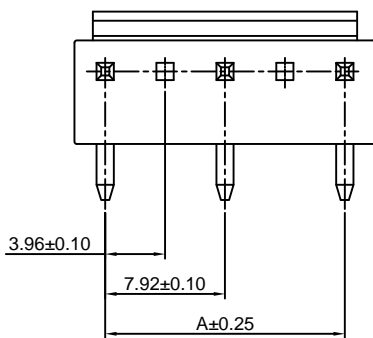
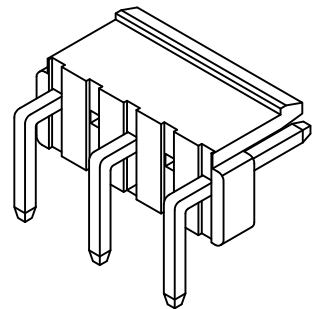

P.C.B LAYOUT

#### Ordering Information & Dimensions:

PART NO.	Dimensions	
	A	B
3P	7.92	11.88
5P	15.84	19.80
7P	23.76	27.72
9P	31.68	35.64
11P	39.60	43.56
13P	47.52	51.48
15P	55.44	59.40

Unit: mm

### A3963WVB-XP-A

7.92mm pitch 180° Wafer

#### Reference Informations:

- \*Material: Pin: Brass/Tin over Nickel  
Insulator: Nylon 66, UL94V-0
- \*Mates with CJT A3963HB-XP series Housing
- \*Color: White

#### Ordering Information:

- A3963WVB-XP-A - <sup>\*\*\*</sup>/<sub>2</sub> - <sup>\*\*</sup>/<sub>3</sub>
1. Part No.
  2. Material:  
(blank): Nylon 66, UL94V-0  
GWT: Nylon 66, UL94V-0, GWT 750°C
  3. Finish:  
(blank): Tin over Nickel  
G: Gold over Nickel

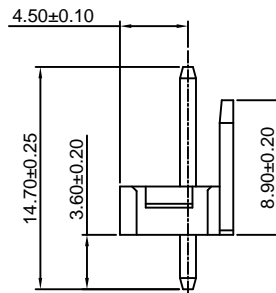
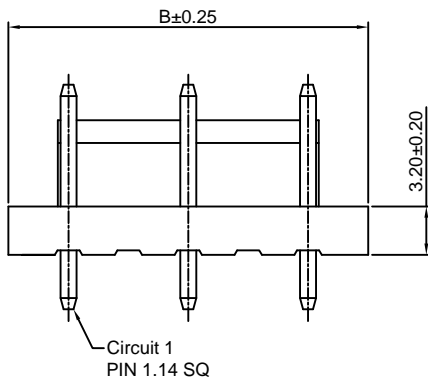
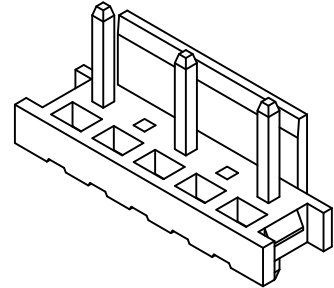
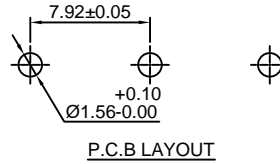
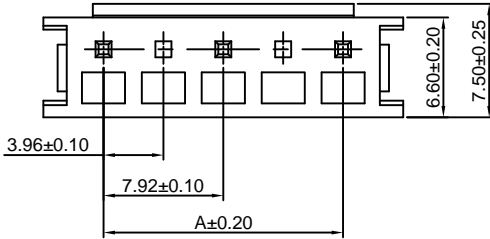

#### Ordering Information & Dimensions:

PART NO.	Dimensions	
	A	B
3P	7.92	15.88
5P	15.84	23.80
7P	23.76	31.72
9P	31.68	39.64
11P	39.60	47.56
13P	47.52	55.48
15P	55.44	63.40

Unit: mm

### A3963WRB-XP-A

7.92mm pitch 90° Wafer

#### Reference Informations:

- \*Material: Pin: Brass/Tin over Nickel  
Insulator: Nylon 66, UL94V-0
- \*Mates with CJT A3963HB-XP series Housing
- \*Color: White

#### Ordering Information:

- A3963WRB-XP-A - <sup>\*\*\*</sup>/<sub>2</sub> - <sup>\*\*</sup>/<sub>3</sub>
1. Part No.
  2. Material:  
(blank): Nylon 66, UL94V-0  
GWT: Nylon 66, UL94V-0, GWT 750°C
  3. Finish:  
(blank): Tin over Nickel  
G: Gold over Nickel

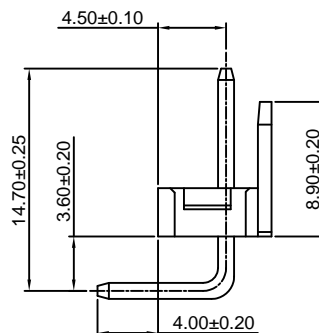
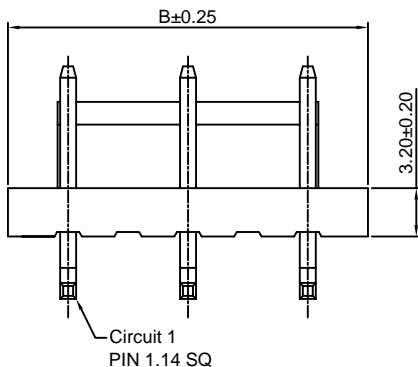
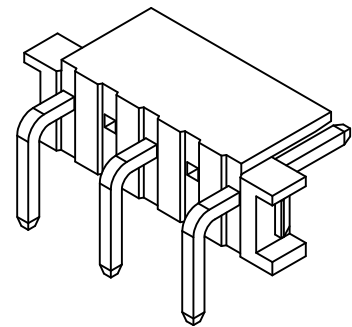
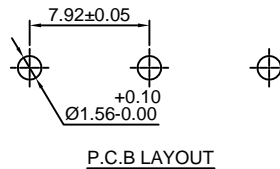
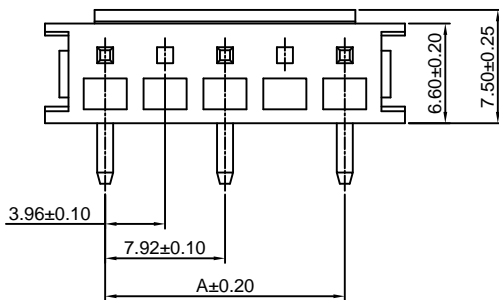

#### Ordering Information & Dimensions:

PART NO.	Dimensions	
	A	B
3P	7.92	15.88
5P	15.84	23.80
7P	23.76	31.72
9P	31.68	39.64
11P	39.60	47.56
13P	47.52	55.48
15P	55.44	63.40

Unit: mm

### A3963WVD-F-XP-H

3.96mm pitch 180° Wafer

#### Reference Informations:

- \*Material: Pin: Brass/Tin over Nickel  
Insulator: PBT+30%GF, UL94V-0
- \*Mates with CJT A3963H, HA-XP series Housing
- \*Color: White

- Ordering Information:  
A3963WVD-F-XP-H - <sup>\*\*\*</sup> - <sup>\*\*</sup> - <sup>\*\*</sup>
1. Part No.  
2. Material:  
(blank): PBT+30%GF, UL94V-0  
GWT: PBT, UL94V-0, GWT 750°C
3. Color:  
(Blank): White  
BK: Black  
BL: Blue  
OR: Orange  
PK: Pink  
4. Finish:  
(blank): Tin over Nickel  
G: Gold over Nickel
- RD: Red  
GN: Green  
YL: Yellow  
GY: Gray

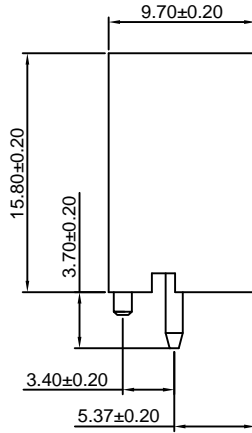
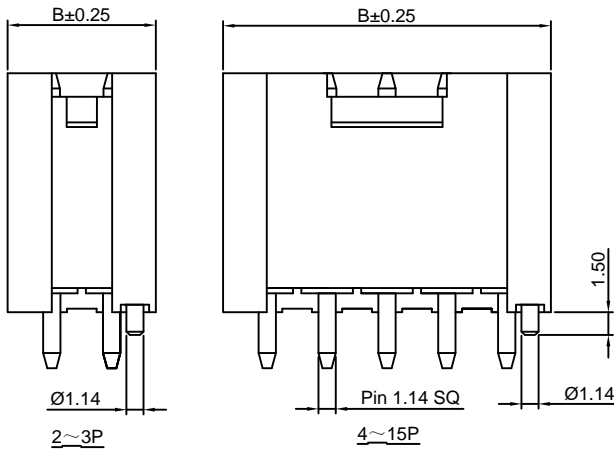
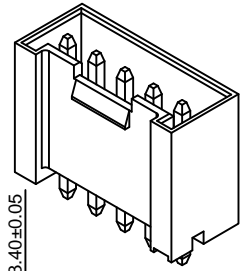
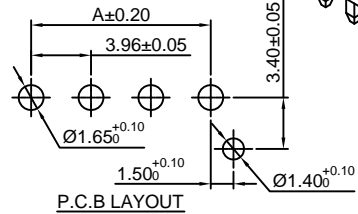
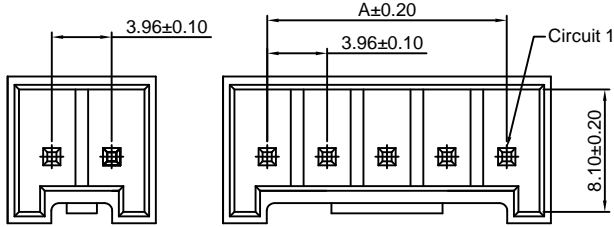

#### Ordering Information & Dimensions:

PART NO.	Dimensions	
	A	B
2P	3.96	9.80
3P	7.92	13.76
4P	11.88	17.72
5P	15.84	21.68
6P	19.80	25.64
7P	23.76	29.60
8P	27.72	33.56
9P	31.68	37.52
10P	35.64	41.48
11P	39.60	45.44
12P	43.56	49.40
13P	47.52	53.36
14P	51.48	57.32
15P	55.44	61.28

Unit: mm

### A3963WVD-F-XP-H-A

7.92mm pitch 180° Wafer

#### Reference Informations:

- \*Material: Pin: Brass/Tin over Nickel  
Insulator: PBT+30%GF, UL94V-0
- \*Mates with CJT A3963H, HA-XP series Housing
- \*Color: White

- Ordering Information:  
A3963WVD-F-XP-H-A - <sup>\*\*\*</sup> - <sup>\*\*</sup> - <sup>\*\*</sup>
1. Part No.  
2. Material:  
(blank): PBT+30%GF, UL94V-0  
GWT: PBT, UL94V-0, GWT 750°C
3. Color:  
(Blank): White  
BK: Black  
BL: Blue  
OR: Orange  
PK: Pink  
4. Finish:  
(blank): Tin over Nickel  
G: Gold over Nickel
- RD: Red  
GN: Green  
YL: Yellow  
GY: Gray

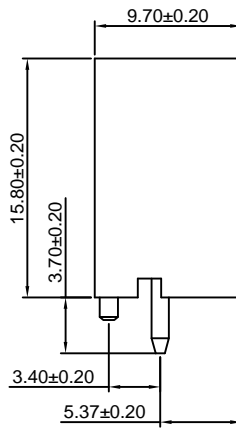
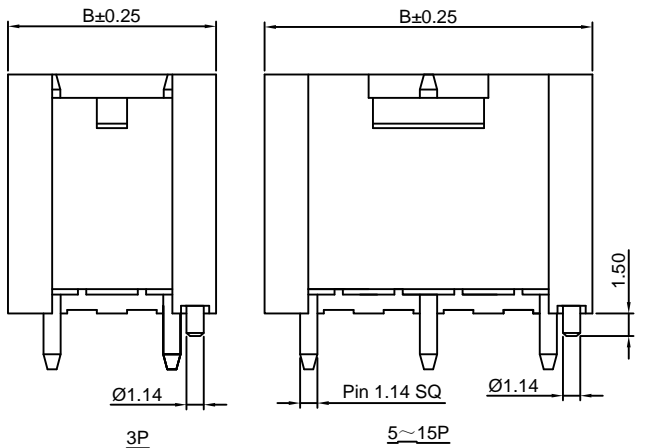
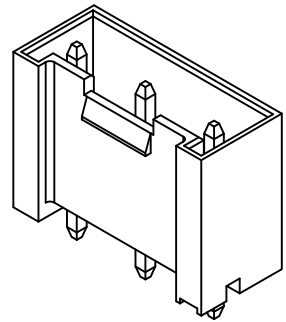
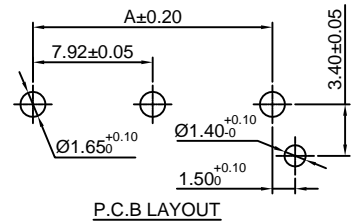
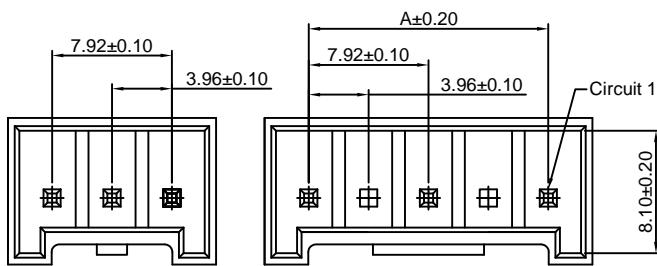

#### Ordering Information & Dimensions:

PART NO.	Dimensions	
	A	B
3P	7.92	13.76
5P	15.84	21.68
7P	23.76	29.60
9P	31.68	37.52
11P	39.60	45.44
13P	47.52	53.36
15P	55.44	61.28

Unit: mm

### A3963WVD-F-XP-A

7.92mm pitch 180° Wafer

#### Reference Informations:

- \*Material: Pin: Brass/Tin over Nickel  
Insulator: PBT+30%GF, UL94V-0
- \*Mates with CJT A3963H, HA-XP series Housing
- \*Color: White

#### Ordering Information:

A3963WVD-F-XP-A - \*\*\* - \*\* - \*\*  
1 2 3 4

- Part No.
- Material:  
(blank): PBT+30%GF, UL94V-0  
GWT: PBT, UL94V-0, GWT 750°C
- Color:  
(Blank): White  
BK: Black      RD: Red  
BL: Blue      GN: Green  
OR: Orange    YL: Yellow  
PK: Pink      GY: Gray
- Finish:  
(blank): Tin over Nickel  
G: Gold over Nickel

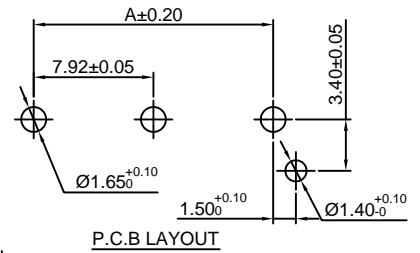
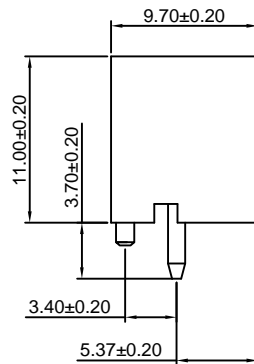
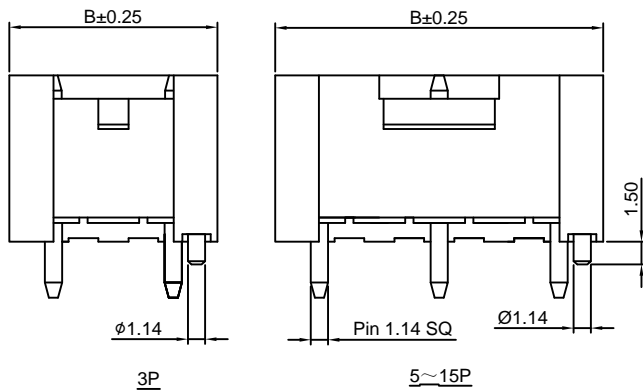
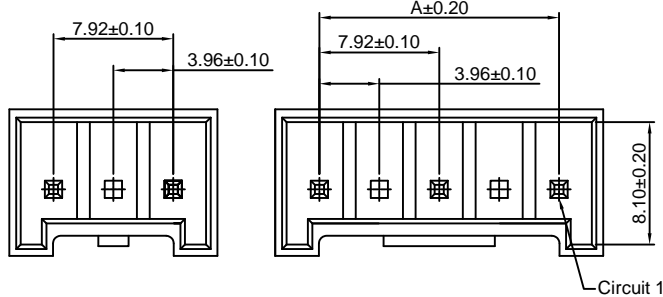
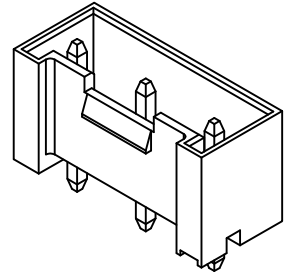

#### Ordering Information & Dimensions:

PART NO.	Dimensions	
	A	B
3P	7.92	13.76
5P	15.84	21.68
7P	23.76	29.60
9P	31.68	37.52
11P	39.60	45.44
13P	47.52	53.36
15P	55.44	61.28

Unit: mm

### A3963WVD-S-XP-A

7.92mm pitch 180° Wafer - SMT TYPE

#### Reference Informations:

- \*Material: Pin: Phosphor Bronze/Tin over Nickel  
Insulator: Nylon 9T, UL94V-0
- \*Mates with CJT A3963H, HA-XP series Housing
- \*Color: Ivory

#### Ordering Information:

A3963WVD-S-XP-A - \*\*\* - \*\*  
1 2 3

- Part No.
- Material:  
(blank): Nylon 9T, UL94V-0  
GWT: Nylon 9T, UL94V-0, GWT 750°C
- Finish:  
(blank): Tin over Nickel  
G: Gold over Nickel

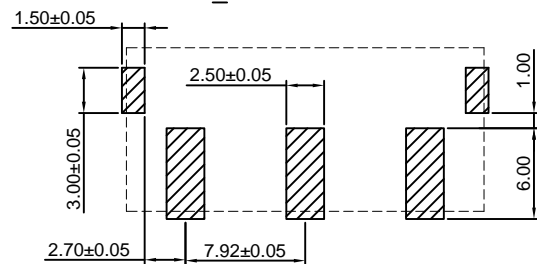
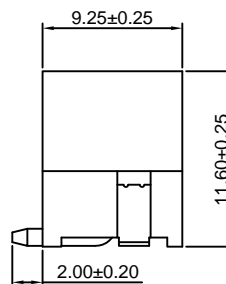
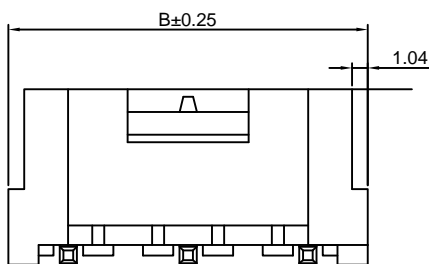
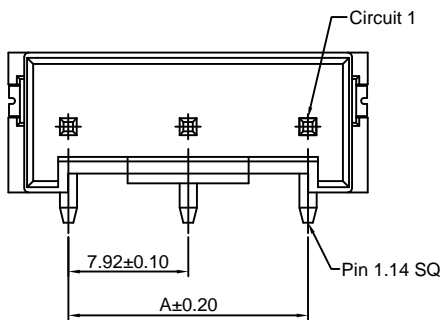

P.C.B LAYOUT

#### Ordering Information & Dimensions:

PART NO.	Dimensions	
	A	B
3P	7.92	15.84
5P	15.84	23.76
7P	23.76	31.68
9P	31.68	39.60

Unit: mm

### A3963WRD-S-XP-A

7.92mm pitch 90° Wafer - SMT TYPE

**Reference Informations:**

- \*Material:Pin:Phosphor Bronze/Tin over Nickel  
Insulator:Nylon 9T,UL94V-0
- \*Mates with CJT A3963H,HA-XP series Housing
- \*Color:Ivory

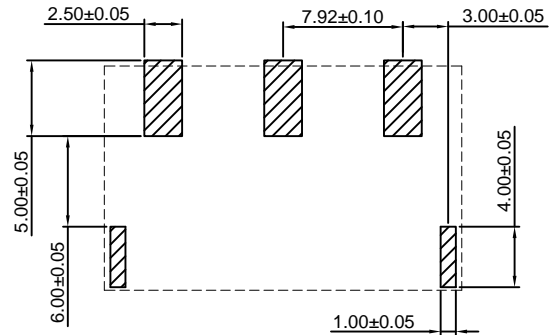
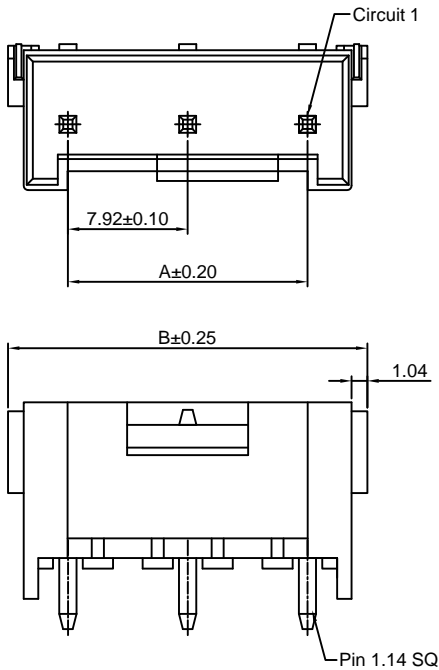

**P.C.B LAYOUT**

Ordering Information:  
A3963WRD-S-XP-A - \*\*\* - \*\*  
1 2 3

- 1.Part No.
- 2.Material:  
(blank):Nylon 9T,UL94V-0  
GWT:Nylon 9T,UL94V-0,GWT 750°C
- 3.Finish:  
(blank):Tin over Nickel  
G:Gold over Nickel

**Ordering Information & Dimensions:**

PART NO.	Dimensions	
	A	B
3P	7.92	15.84
5P	15.84	23.76
7P	23.76	31.68
9P	31.68	39.60

Unit: mm

### A3963WRH-XP

3.96mm pitch 90° Wafer

**Reference Informations:**

- \*Material:Pin:Brass/Tin over Nickel  
Insulator:Nylon 66,UL94V-0
- \*Mates with CJT A3963H,HA,HC-XP series Housing
- \*Color:White

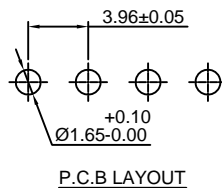
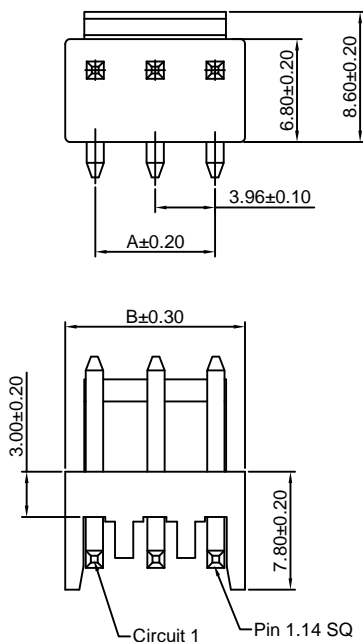

Ordering Information:  
A3963WRH-XP - \*\*\* - \*\* - \*\*  
1 2 3 4

- 1.Part No.
- 2.Material:  
(blank):Nylon 66,UL94V-0  
GWT:Nylon 66,UL94V-0,GWT 750°C
- 3.Color:  
(Blank):White  
BK:Black  
RD:Red  
BL:Blue  
GN:Green  
YL:Yellow
- 4.Finish:  
(blank):Tin over Nickel  
G:Gold over Nickel

**Ordering Information & Dimensions:**

PART NO.	Dimensions	
	A	B
2P	3.96	7.92
3P	7.92	11.88
4P	11.88	15.84
5P	15.84	19.80
6P	19.80	23.76
7P	23.76	27.72
8P	27.72	31.68
9P	31.68	35.64
10P	35.64	39.60
11P	39.60	43.56
12P	43.56	47.52
13P	47.52	51.48
14P	51.48	55.44
15P	55.44	59.40



### A3963WRH-XP-A

7.92mm pitch 90° Wafer

#### Reference Informations:

- \*Material: Pin: Brass/Tin over Nickel  
Insulator: Nylon 66, UL94V-0
- \*Mates with CJT A3963H, HA, HC-XP series Housing
- \*Color: White

#### Ordering Information:

A3963WRH-XP-A - <sup>\*\*\*</sup>/<sub>2</sub> - <sup>\*\*</sup>/<sub>3</sub> - <sup>\*\*</sup>/<sub>4</sub>

1. Part No.
2. Material:  
(blank): Nylon 66, UL94V-0  
GWT: Nylon 66, UL94V-0, GWT 750°C
3. Color:  
(Blank): White  
BK: Black  
RD: Red  
BL: Blue  
GN: Green  
YL: Yellow
4. Finish:  
(blank): Tin over Nickel  
G: Gold over Nickel

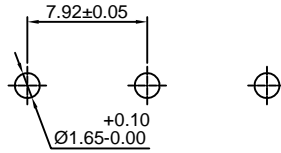
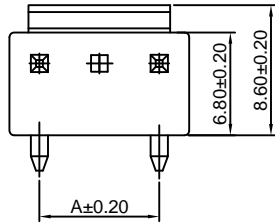

P.C.B LAYOUT

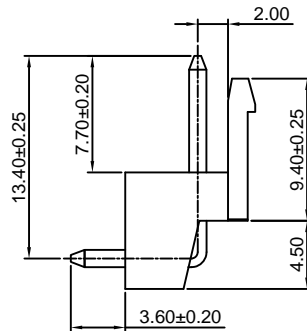
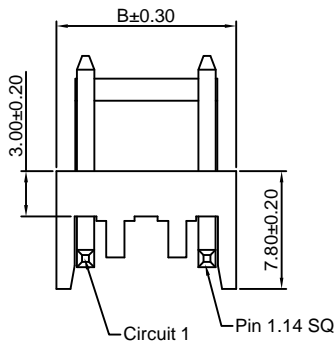

#### Ordering Information & Dimensions:

PART NO.	Dimensions	
	A	B
3P	7.92	11.88
5P	15.84	19.80
7P	23.76	27.72
9P	31.68	35.64
11P	39.60	43.56
13P	47.52	51.48
15P	55.44	59.40

Unit: mm

### A7921WR-F-2P

7.92mm pitch 90° Wafer

#### Reference Informations:

- \*Material: Pin: Brass/Tin over Nickel  
Insulator: PBT, UL94V-0
- \*Mates with CJT A3963H-3P Housing
- \*Color: White

#### Ordering Information:

A7921WR-F-2P - <sup>\*\*\*</sup>/<sub>2</sub> - <sup>\*\*</sup>/<sub>3</sub>

1. Part No.
2. Material:  
(blank): PBT, UL94V-0  
GWT: PBT, UL94V-0, GWT 750°C
3. Finish:  
(blank): Tin over Nickel  
G: Gold over Nickel

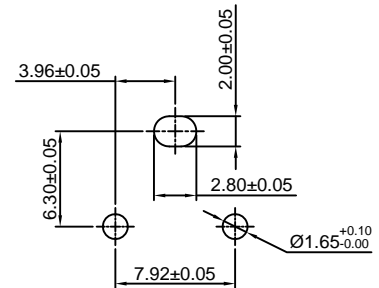
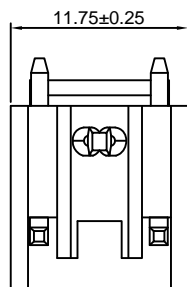
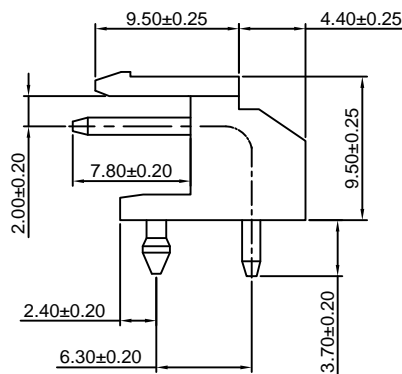
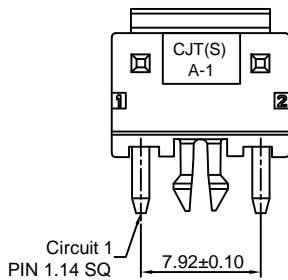

P.C.B LAYOUT

Unit: mm

## X-ON Electronics

Largest Supplier of Electrical and Electronic Components

*Click to view similar products for [Headers & Wire Housings](#) category:*

*Click to view products by [Changjiang](#) manufacturer:*

Other Similar products are found below :

[95000-104TRLF](#) [10135584-644402LF](#) [DF62W-EP2022PCA](#) [95000-106TRLF](#) [DF62W-2022SCA](#) [DF62W-EP2022PC](#) [2203348](#) [DF62W-2022SC](#) [1084018](#) [1029039](#) [1084017](#) [802-10-012-10-002000](#) [1112640](#) [1112639](#) [891-007-9SS-BST1T](#) [000-34000](#) [0008550134](#) [0009482033](#) [0009507031](#) [57102-F02-18ULF](#) [57102-S06-03LF](#) [57202-S52-04LF](#) [PCN6-15S-2.5E](#) [0039019024](#) [58102-G61-06LF](#) [582553-1](#) [0009485154](#) [0009508121](#) [0022285053](#) [0050291907](#) [018731A](#) [LY20-4P-DT1-P1E-BR](#) [02.125.8002.8](#) [60101931](#) [60598-1 \(Cut Strip\)](#) [M1625-3R/100](#) [61062-3](#) [61082-181009](#) [CSU011177004](#) [636-1427](#) [638009-1](#) [641938-9](#) [641991-4](#) [644168-1](#) [644827-2](#) [647662-1](#) [65039-019ELF](#) [65692-001LF](#) [65781-018](#) [65781-047](#)