

Specifications

- Current rating:7A AC,DC
- Voltage rating:250V AC,DC
- Temperature range:-40°C~+105°C
- Contact resistance:10mΩMax.
- Insulation resistance:1000MΩMin.
- Withstanding voltage:1500V AC/minute
- *Compliant with RoHS and REACH*
- *Meet the HF/Halogen Free,GWT/Glow wire Test (IEC60335-1) request,need to customize*
- *Contact CJT for details*

Standards



Assembly layout

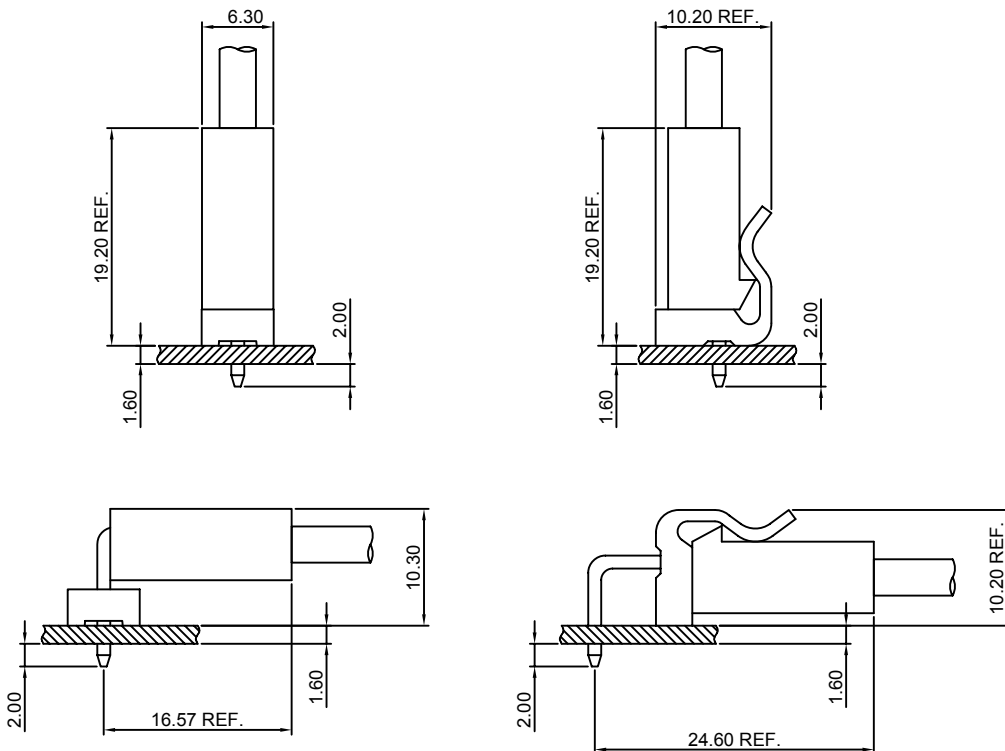

A5081H-XP

5.08mm pitch Housing

Reference Informations:

- *Material:Nylon 66,UL94V-2
- *Suitable CJT A3961-T(-1) series Terminal
- *Mates with CJT A5081WV,WR,WVA,WRA-XP(-A),A5081WVB-XP A5081WV-XP-R(-A),A5081WVA-XP-R(-A) series Wafer
- *Color:Natural

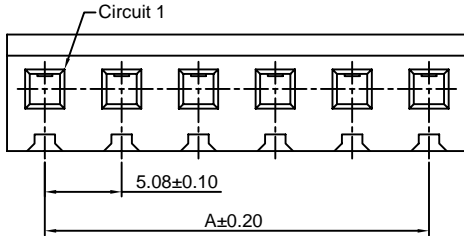
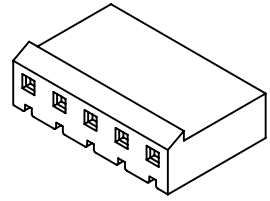

Ordering Information:

A5081H-XP - * - ***
1 2 3

- 1.Part No.
- 2.Style:
(blank)-Type 1
2-Type 2
- 3.Material:
(blank)-Nylon 66,UL94V-2(Natural)
V0-Nylon 66,UL94V-0(White)
GWT-Nylon 66,UL94V-0,GWT 750°C

Ordering Information & Dimensions:

PART NO.	Dimensions	
	A	B
2P	5.08	10.08
3P	10.16	15.16
4P	15.24	20.24
5P	20.32	25.32
6P	25.40	30.40
7P	30.48	35.48
8P	35.56	40.56
9P	40.64	45.64
10P	45.72	50.72
11P	50.80	55.80
12P	55.88	60.88
13P	60.96	65.96
14P	66.04	71.04
15P	71.12	76.12
16P	76.20	81.20
17P	81.28	86.28
18P	86.36	91.36
19P	91.44	96.44
20P	96.52	101.52

Unit: mm

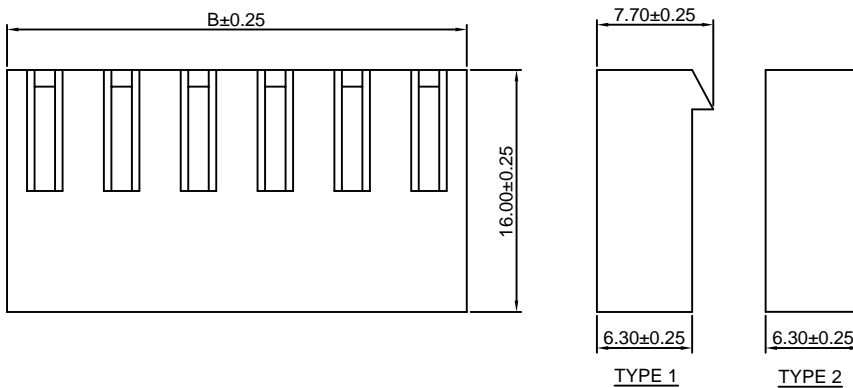

A5081WV-XP

5.08mm pitch 180° Wafer

Reference Informations:

- *Material:Pin:Brass/Tin over Nickel
Insulator:Nylon 66,UL94V-2
- *Mates with CJT A5081H-XP,A5082H-XP, A5082H-XP-A series Housing
- *Color:Natural

Ordering Information:

A5081WV-XP - *** - **
1 2 3

- 1.Part No.
- 2.Material:
(blank):Nylon 66,UL94V-2(Natural)
V0:Nylon 66,UL94V-0(White)
GWT:Nylon 66,UL94V-0,GWT 750°C
- 3.Finish:
(blank):Tin over Nickel
G:Gold over Nickel

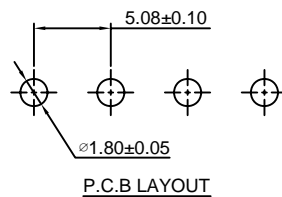
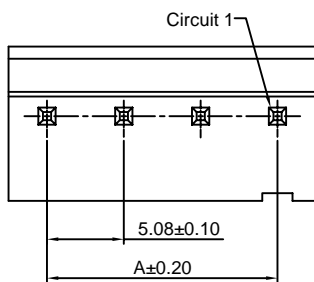
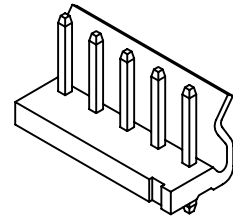

Ordering Information & Dimensions:

PART NO.	Dimensions	
	A	B
2P	5.08	10.16
3P	10.16	15.24
4P	15.24	20.32
5P	20.32	25.40
6P	25.40	30.48
7P	30.48	35.56
8P	35.56	40.64
9P	40.64	45.72
10P	45.72	50.80
11P	50.80	55.88
12P	55.88	60.96
13P	60.96	66.04
14P	66.04	71.12
15P	71.12	76.20
16P	76.20	81.28
17P	81.28	86.36
18P	86.36	91.44
19P	91.44	96.52
20P	96.52	101.60

Unit: mm

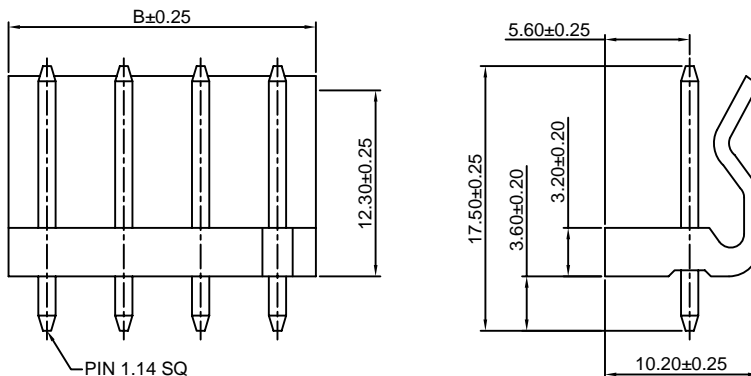

A5081WR-XP

5.08mm pitch 90° Wafer

Reference Informations:

- *Material: Pin: Brass/Tin over Nickel
Insulator: Nylon 66, UL94V-2
- *Mates with CJT A5081H-XP, A5082H-XP, A5082H-XP-A series Housing
- *Color: Natural

Ordering Information:

A5081WR-XP - $\frac{***}{2} - \frac{**}{3}$

1. Part No.
2. Material:
(blank): Nylon 66, UL94V-2 (Natural)
V0: Nylon 66, UL94V-0 (White)
GWT: Nylon 66, UL94V-0, GWT 750°C
3. Finish:
(blank): Tin over Nickel
G: Gold over Nickel

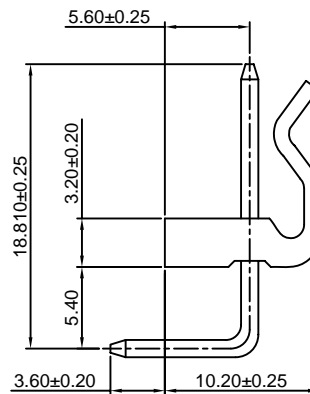
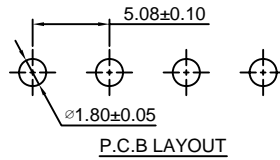
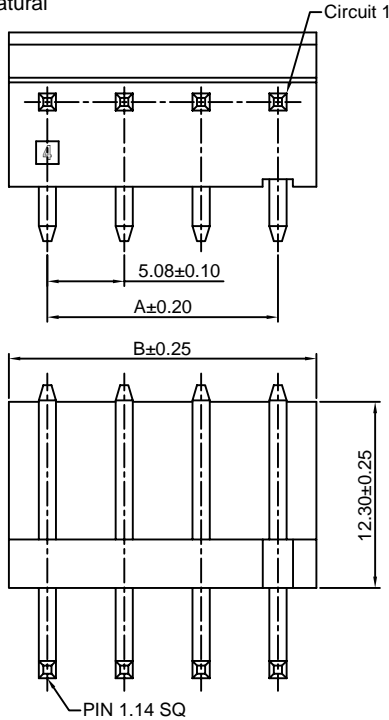
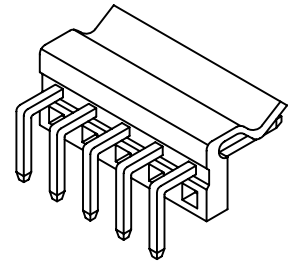

Ordering Information & Dimensions:

PART NO.	Dimensions	
	A	B
2P	5.08	10.16
3P	10.16	15.24
4P	15.24	20.32
5P	20.32	25.40
6P	25.40	30.48
7P	30.48	35.56
8P	35.56	40.64
9P	40.64	45.72
10P	45.72	50.80
11P	50.80	55.88
12P	55.88	60.96
13P	60.96	66.04
14P	66.04	71.12
15P	71.12	76.20
16P	76.20	81.28
17P	81.28	86.36
18P	86.36	91.44
19P	91.44	96.52
20P	96.52	101.60

Unit: mm

A5081WVA-XP

5.08mm pitch 180° Wafer

Reference Informations:

- *Material: Pin: Brass/Tin over Nickel
Insulator: Nylon 66, UL94V-2
- *Mates with CJT A5081H-XP, A5082H-XP, A5082H-XP-A series Housing
- *Color: Natural

Ordering Information:

A5081WVA-XP - $\frac{***}{2} - \frac{**}{3}$

1. Part No.
2. Material:
(blank): Nylon 66, UL94V-2 (Natural)
V0: Nylon 66, UL94V-0 (White)
GWT: Nylon 66, UL94V-0, GWT 750°C
3. Finish:
(blank): Tin over Nickel
G: Gold over Nickel

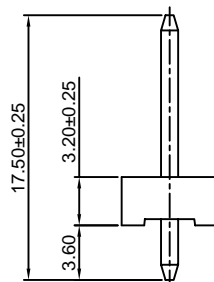
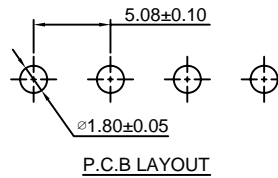
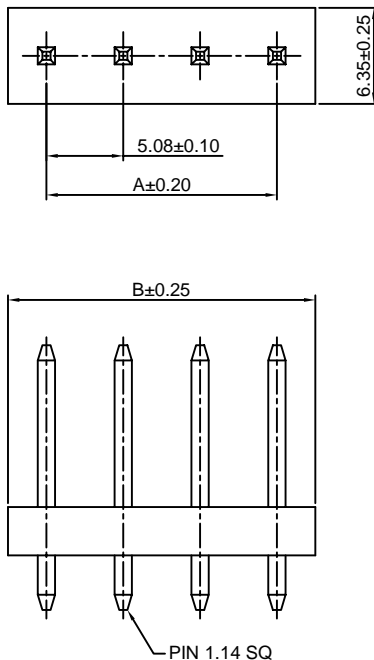
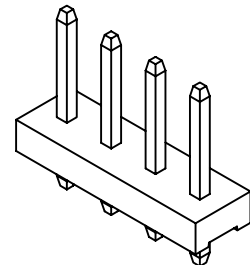

Ordering Information & Dimensions:

PART NO.	Dimensions	
	A	B
2P	5.08	10.16
3P	10.16	15.24
4P	15.24	20.32
5P	20.32	25.40
6P	25.40	30.48
7P	30.48	35.56
8P	35.56	40.64
9P	40.64	45.72
10P	45.72	50.80
11P	50.80	55.88
12P	55.88	60.96
13P	60.96	66.04
14P	66.04	71.12
15P	71.12	76.20
16P	76.20	81.28
17P	81.28	86.36
18P	86.36	91.44
19P	91.44	96.52
20P	96.52	101.60

Unit: mm

A5081WRA-XP

5.08mm pitch 90° Wafer

Reference Informations:

- *Material: Pin: Brass/Tin over Nickel
Insulator: Nylon 66, UL94V-2
- *Mates with CJT A5081H-XP, A5082H-XP, A5082H-XP-A series Housing
- *Color: Natural

Ordering Information:

A5081WRA-XP - *** - **
1 2 3

1. Part No.
2. Material:
(blank): Nylon 66, UL94V-2 (Natural)
V0: Nylon 66, UL94V-0 (White)
GWT: Nylon 66, UL94V-0, GWT 750°C
3. Finish:
(blank): Tin over Nickel
G: Gold over Nickel

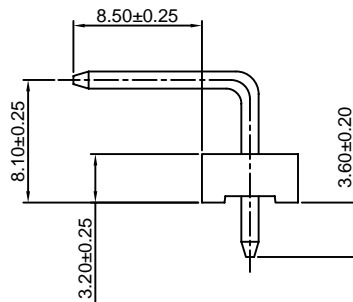
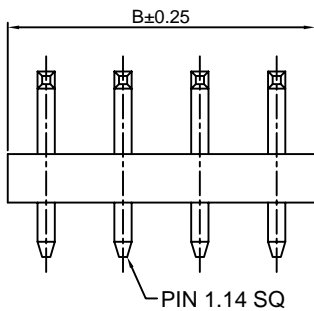
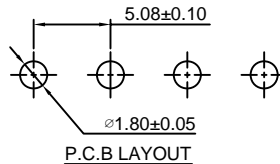
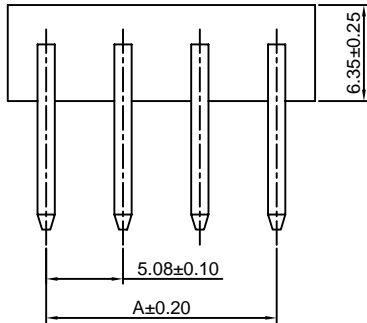
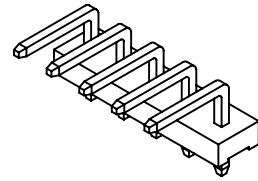

Ordering Information & Dimensions:

PART NO.	Dimensions	
	A	B
2P	5.08	10.16
3P	10.16	15.24
4P	15.24	20.32
5P	20.32	25.40
6P	25.40	30.48
7P	30.48	35.56
8P	35.56	40.64
9P	40.64	45.72
10P	45.72	50.80
11P	50.80	55.88
12P	55.88	60.96
13P	60.96	66.04
14P	66.04	71.12
15P	71.12	76.20
16P	76.20	81.28
17P	81.28	86.36
18P	86.36	91.44
19P	91.44	96.52
20P	96.52	101.60

Unit: mm

A5081WVB-XP

5.08mm pitch 180° Wafer

Reference Informations:

- *Material: Pin: Brass/Tin over Nickel
Insulator: Nylon 66, UL94V-2
- *Mates with CJT A5081H-XP, A5082H-XP, A5082H-XP-A series Housing
- *Color: Natural

Ordering Information:

A5081WVB-XP - *** - **
1 2 3

1. Part No.
2. Material:
(blank): Nylon 66, UL94V-2 (Natural)
V0: Nylon 66, UL94V-0 (White)
GWT: Nylon 66, UL94V-0, GWT 750°C
3. Finish:
(blank): Tin over Nickel
G: Gold over Nickel

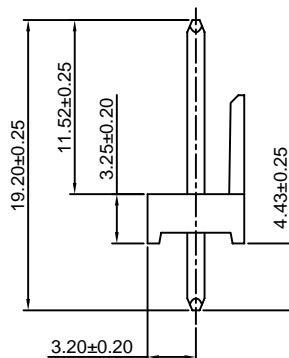
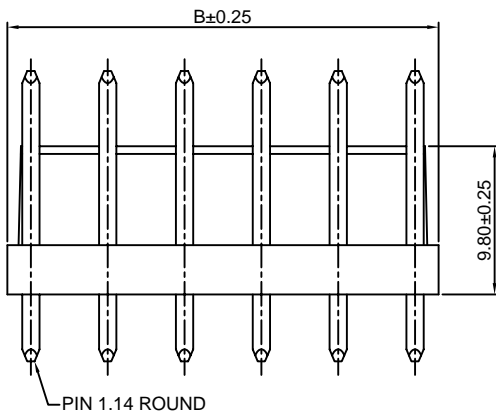
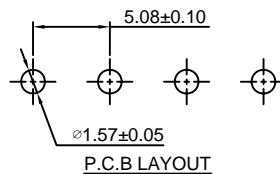
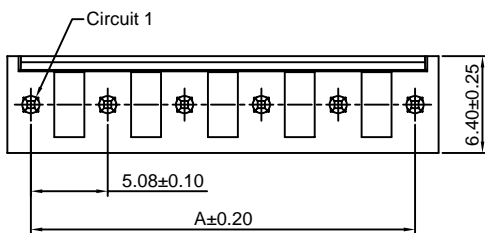
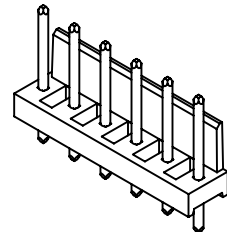

Ordering Information & Dimensions:

PART NO.	Dimensions	
	A	B
2P	5.08	8.20
3P	10.16	13.28
4P	15.24	18.36
5P	20.32	23.44
6P	25.40	28.52
7P	30.48	33.60
8P	35.56	38.68
9P	40.64	43.76
10P	45.72	48.84
11P	50.80	53.92
12P	55.88	59.00
13P	60.96	64.08
14P	66.04	69.16
15P	71.12	74.24
16P	76.20	79.32
17P	81.28	84.40
18P	86.36	89.48
19P	91.44	94.56
20P	96.52	99.64

Unit: mm

A5081WV-XP-R

5.08mm pitch 180° Wafer Round Pin

Reference Informations:

- *Material:Pin:Brass/Tin over Nickel
Insulator:Nylon 66,UL94V-2
- *Mates with CJT A5081H-XP,A5082H-XP,
A5082H-XP-A series Housing
- *Color:Natural

Ordering Information:

A5081WV-XP-R - *** - **
1 2 3

- Part No.
- Material:
(blank):Nylon 66,UL94V-2(Natural)
V0:Nylon 66,UL94V-0(White)
GWT:Nylon 66,UL94V-0,GWT 750°C
- Finish:
(blank):Tin over Nickel
G:Gold over Nickel

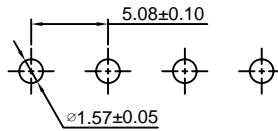
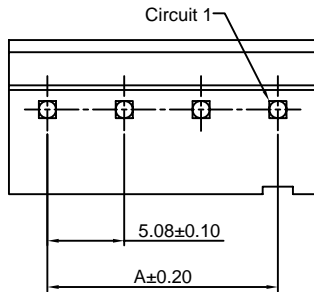
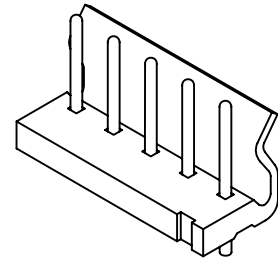

P.C.B LAYOUT

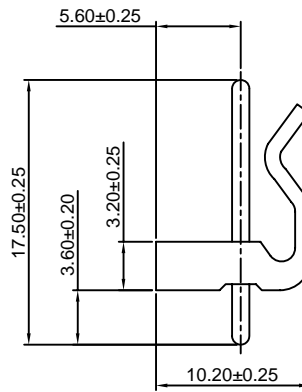
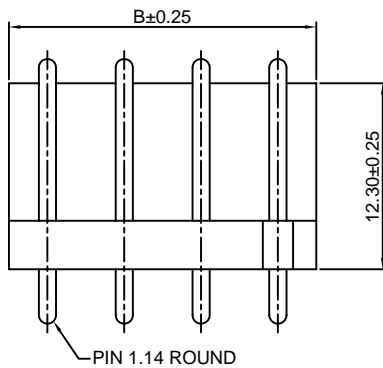

Ordering Information & Dimensions:

PART NO.	Dimensions	
	A	B
2P	5.08	10.16
3P	10.16	15.24
4P	15.24	20.32
5P	20.32	25.40
6P	25.40	30.48
7P	30.48	35.56
8P	35.56	40.64
9P	40.64	45.72
10P	45.72	50.80
11P	50.80	55.88
12P	55.88	60.96
13P	60.96	66.04
14P	66.04	71.12
15P	71.12	76.20
16P	76.20	81.28
17P	81.28	86.36
18P	86.36	91.44
19P	91.44	96.52
20P	96.52	101.60

Unit: mm

A5081WVA-XP-R

5.08mm pitch 180° Wafer Round Pin

Reference Informations:

- *Material:Pin:Brass/Tin over Nickel
Insulator:Nylon 66,UL94V-2
- *Mates with CJT A5081H-XP,A5082H-XP,
A5082H-XP-A series Housing
- *Color:Natural

Ordering Information:

A5081WVA-XP-R - *** - **
1 2 3

- Part No.
- Material:
(blank):Nylon 66,UL94V-2(Natural)
V0:Nylon 66,UL94V-0(White)
GWT:Nylon 66,UL94V-0,GWT 750°C
- Finish:
(blank):Tin over Nickel
G:Gold over Nickel

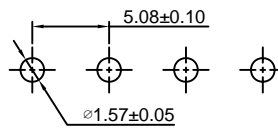
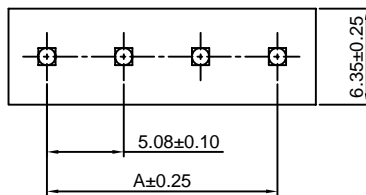
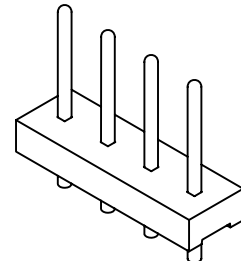

P.C.B LAYOUT

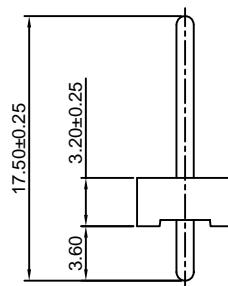
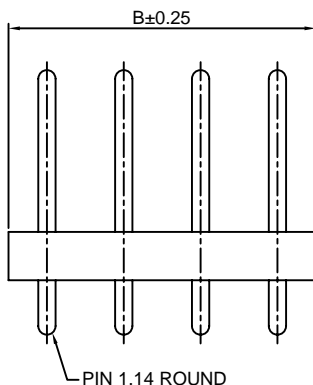

Ordering Information & Dimensions:

PART NO.	Dimensions	
	A	B
2P	5.08	10.16
3P	10.16	15.24
4P	15.24	20.32
5P	20.32	25.40
6P	25.40	30.48
7P	30.48	35.56
8P	35.56	40.64
9P	40.64	45.72
10P	45.72	50.80
11P	50.80	55.88
12P	55.88	60.96
13P	60.96	66.04
14P	66.04	71.12
15P	71.12	76.20
16P	76.20	81.28
17P	81.28	86.36
18P	86.36	91.44
19P	91.44	96.52
20P	96.52	101.60

Unit: mm

A5081WV-XP-A

10.16mm pitch 180° Wafer

Reference Informations:

- *Material: Pin: Brass/Tin over Nickel
Insulator: Nylon 66, UL94V-2
- *Mates with CJT A5081H-XP, A5082H-XP, A5082H-XP-A series Housing
- *Color: Natural

Ordering Information:

A5081WV-XP-A - *** - **
1 2 3

1. Part No.
2. Material:
(blank): Nylon 66, UL94V-2 (Natural)
V0: Nylon 66, UL94V-0 (White)
GWT: Nylon 66, UL94V-0, GWT 750°C
3. Finish:
(blank): Tin over Nickel
G: Gold over Nickel

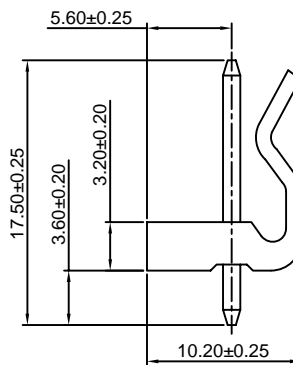
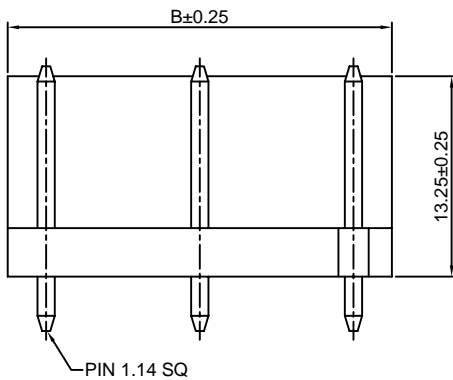
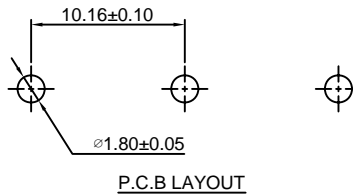
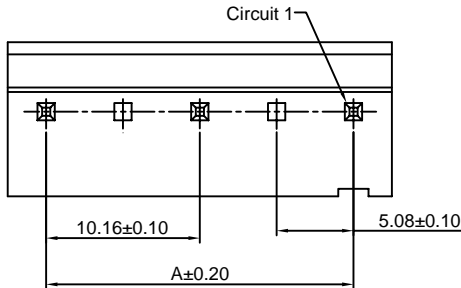
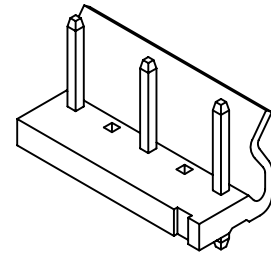

Ordering Information & Dimensions:

PART NO.	Dimensions	
	A	B
3P	10.16	15.24
5P	20.32	25.40
7P	30.48	35.56
9P	40.64	45.72
11P	50.80	55.88
13P	60.96	66.04
15P	71.12	76.20
17P	81.28	86.36
19P	91.44	96.52

Unit: mm

A5081WR-XP-A

10.16mm pitch 90° Wafer

Reference Informations:

- *Material: Pin: Brass/Tin over Nickel
Insulator: Nylon 66, UL94V-2
- *Mates with CJT A5081H-XP, A5082H-XP, A5082H-XP-A series Housing
- *Color: Natural

Ordering Information:

A5081WR-XP-A - *** - **
1 2 3

1. Part No.
2. Material:
(blank)-Nylon 66, UL94V-2 (Natural)
V0-Nylon 66, UL94V-0 (White)
GWT-Nylon 66, UL94V-0, GWT 750°C
3. Finish:
(blank): Tin over Nickel
G: Gold over Nickel

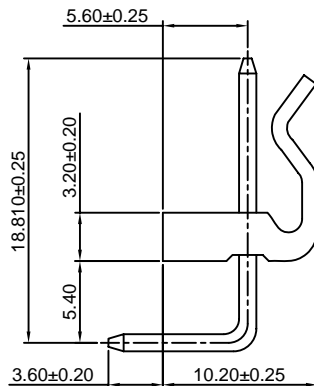
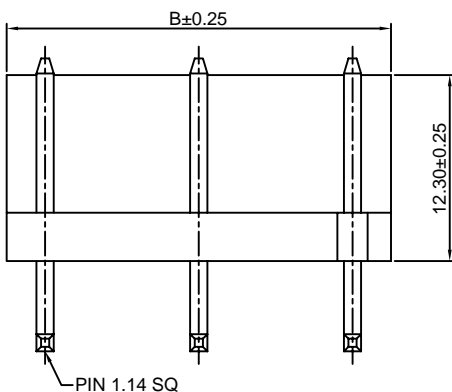
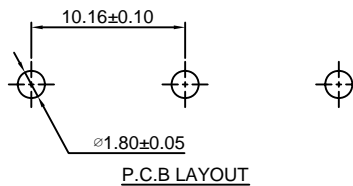
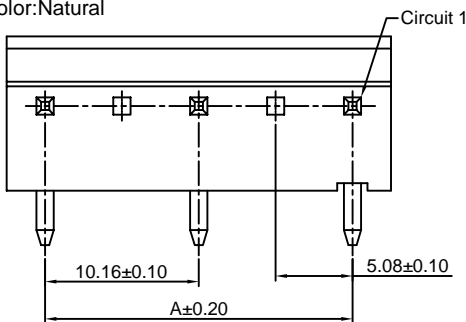
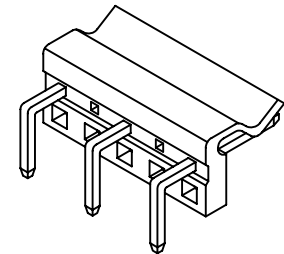

Ordering Information & Dimensions:

PART NO.	Dimensions	
	A	B
3P	10.16	15.24
5P	20.32	25.40
7P	30.48	35.56
9P	40.64	45.72
11P	50.80	55.88
13P	60.96	66.04
15P	71.12	76.20
17P	81.28	86.36
19P	91.44	96.52

Unit: mm

X-ON Electronics

Largest Supplier of Electrical and Electronic Components

Click to view similar products for [Headers & Wire Housings](#) category:

Click to view products by [Changjiang](#) manufacturer:

Other Similar products are found below :

[95000-104TRLF](#) [10135584-644402LF](#) [DF62W-EP2022PCA](#) [95000-106TRLF](#) [DF62W-2022SCA](#) [DF62W-EP2022PC](#) [2203348](#) [DF62W-2022SC](#) [1084018](#) [1029039](#) [1084017](#) [802-10-012-10-002000](#) [1112640](#) [1112639](#) [891-007-9SS-BST1T](#) [000-34000](#) [0008550134](#) [0009482033](#) [0009507031](#) [57102-F02-18ULF](#) [57102-S06-03LF](#) [57202-S52-04LF](#) [PCN6-15S-2.5E](#) [0039019024](#) [58102-G61-06LF](#) [582553-1](#) [0009485154](#) [0009508121](#) [0022285053](#) [0050291907](#) [018731A](#) [LY20-4P-DT1-P1E-BR](#) [02.125.8002.8](#) [60101931](#) [60598-1 \(Cut Strip\)](#) [M1625-3R/100](#) [61062-3](#) [61082-181009](#) [CSU011177004](#) [636-1427](#) [638009-1](#) [641938-9](#) [641991-4](#) [644168-1](#) [644827-2](#) [647662-1](#) [65039-019ELF](#) [65692-001LF](#) [65781-018](#) [65781-047](#)