

Specifications

- Current rating:4A AC,DC
- Voltage rating:250V AC,DC
- Temperature range:-40°C~+105°C
- Contact resistance:10mΩMax.
- Insulation resistance:1000MΩMin.
- Withstanding voltage:1000V AC/minute
- *Compliant with RoHS and REACH*
- *Meet the HF/Halogen Free,need to customize*
- *Contact CJT for details*

Standards



Assembly layout

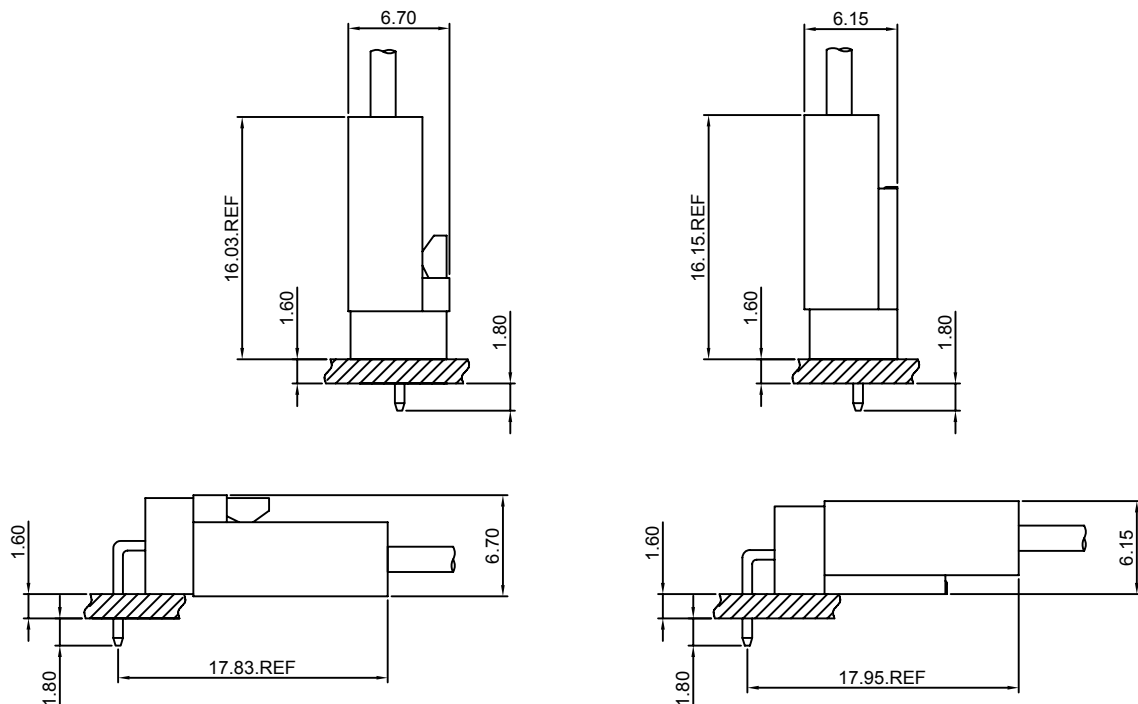

A2543-T

2.54mm Pitch Crimp Terminal

Reference Informations:

*Used in CJT A2543H-XP, A2543HA, HB-XP-WH, A2543HC-4P, C2504AH-XP series Housing

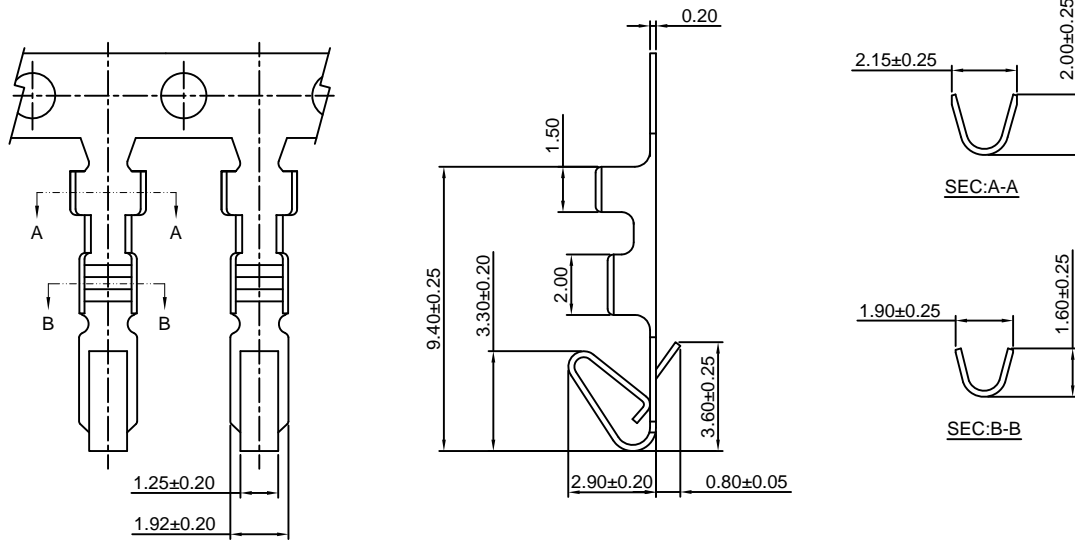

Ordering information & Specifications:

Unit:mm

Part NO.	Wire Range	Insulation O.D.	Material	Finish	Qty/reel
A2543-TB	AWG#22-#28	1.90mm(max)	Brass	Tin over Nickel	10,000 PCS
A2543-TP	AWG#22-#28	1.90mm(max)	Phosphor Bronze	Tin over Nickel	10,000 PCS
A2543-GB	AWG#22-#28	1.90mm(max)	Brass	Gold over Nickel	10,000 PCS
A2543-GP	AWG#22-#28	1.90mm(max)	Phosphor Bronze	Gold over Nickel	10,000 PCS

Optional Gold plating available but MOQ requested

A2543H-XP

2.54mm Pitch Housing

Reference Informations:

*Material:Nylon 66,UL94V-0

*Suitable CJT A2543-T series Terminal

*Mates with CJT A2543WV, WR-XP, A2543WR-XP-L,

A2543WR-S-XP series Wafer

*Color:Beige or White

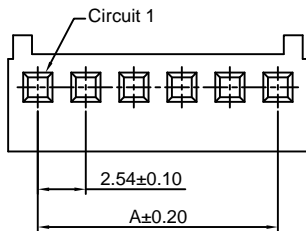

Ordering Information:

A2543H-XP - * - ***

1 2 3

1.Part No.

2.Style:

(blank) :Type 1/Beige

2 :Type 2/White

3.Material:

(Blank):Nylon 66,UL94V-0

GWT:Nylon 66,UL94V-0,GWT 750 °C

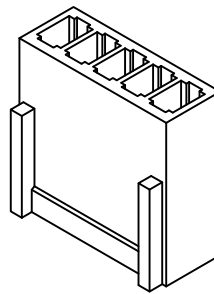

Ordering Information & Dimensions:

PART NO.	Dimensions	
	A	B
2P	2.54	5.68
3P	5.08	8.22
4P	7.62	10.76
5P	10.16	13.30
6P	12.70	15.84
7P	15.24	18.38
8P	17.78	20.92
9P	20.32	23.46
10P	22.86	26.00
11P	25.40	28.54
12P	27.94	31.08
13P	30.48	33.62
14P	33.02	36.16
15P	35.56	38.70
16P	38.10	41.24
17P	40.64	43.78
18P	43.18	46.32
19P	45.72	48.86
20P	48.26	51.40
21P	50.80	53.94
22P	53.34	56.48
23P	55.88	59.02
24P	58.42	61.56
25P	60.96	64.10

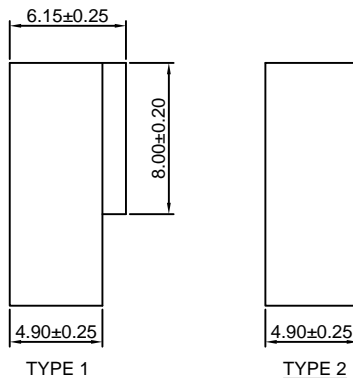
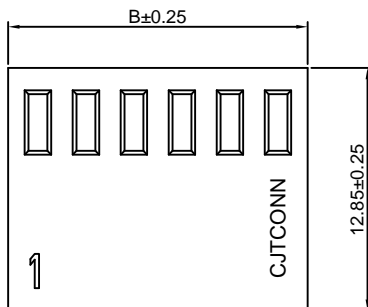

Unit: mm

A2543HC-4P

2.54mm Pitch Housing

Reference Informations:

- *Material:Nylon 66,UL94V-0
- *Suitable CJT A2543-T series Terminal
- *Mates with CJT A2543WVC-4P series Wafer
- *Color:Beige

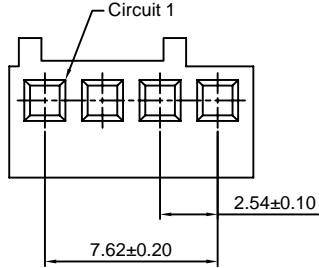

Ordering Information:

- A2543H-4P - ***
 1 2
- 1.Part No.
 2.Material:
 (Blank):Nylon 66,UL94V-0
 GWT:Nylon 66,UL94V-0,GWT 750 °C

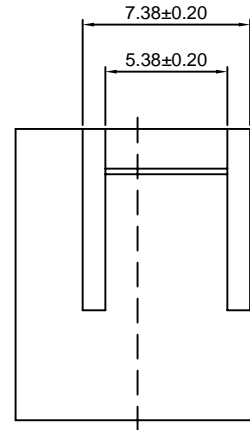
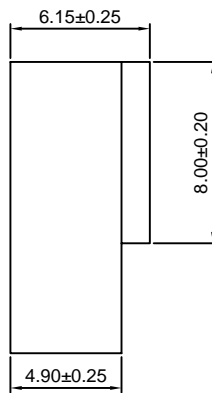
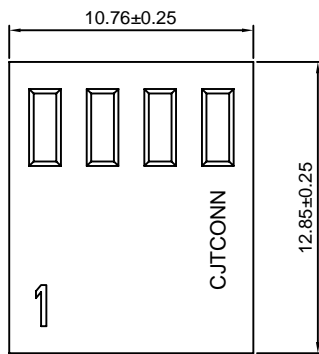
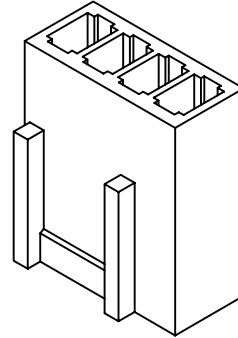

Unit: mm

A2543WV-XP

2.54mm pitch 180° Wafer

Reference Informations:

- *Material:Pin:Brass/Tin over Nickel
 Insulator:Nylon 66,UL94V-0
- *Mates with CJT A2543H-XP series Housing
- *Color:Beige

Ordering Information:

- A2543WV-XP - *** - **
 1 2 3
- 1.Part No.
 2.Material:
 (Blank):Nylon 66,UL94V-0
 GWT:Nylon 66,UL94V-0,GWT 750 °C
- 3.Finish:
 (blank):Tin over Nickel
 G:Gold over Nickel

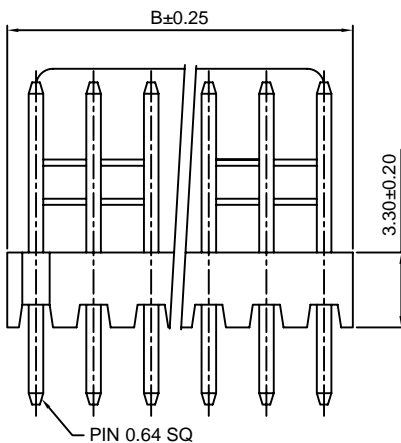
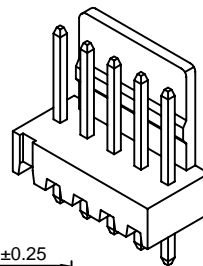
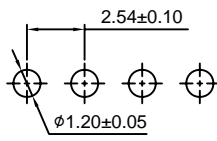
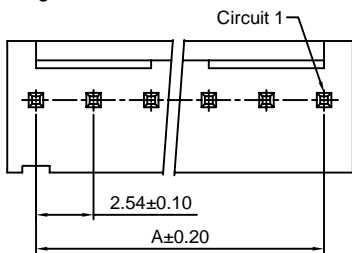

P.C.B LAYOUT

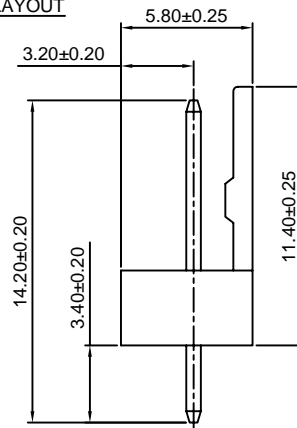

Ordering Information & Dimensions:

PART NO.	Dimensions	
	A	B
2P	2.54	5.08
3P	5.08	7.62
4P	7.62	10.16
5P	10.16	12.70
6P	12.70	15.24
7P	15.24	17.78
8P	17.78	20.32
9P	20.32	22.86
10P	22.86	25.40
11P	25.40	27.94
12P	27.94	30.48
13P	30.48	33.02
14P	33.02	35.56
15P	35.56	38.10
16P	38.10	40.64
17P	40.64	43.18
18P	43.18	45.72
19P	45.72	48.26
20P	48.26	50.80
21P	50.80	53.34
22P	53.34	55.88
23P	55.88	58.42
24P	58.42	60.96
25P	60.96	63.50
26P	63.50	66.04
27P	66.04	68.58
28P	68.58	71.12

Unit: mm

A2543WR-XP

— 2.54mm pitch 90° Wafer —

Reference Informations:

- *Material: Pin: Brass/Tin over Nickel
Insulator: Nylon 66, UL94V-0
- *Mates with CJT A2543H-XP series Housing
- *Color: Beige

Ordering Information:

A2543WR-XP - * - *** - **
1 2 3 4

1. Part No.
2. Style:
(blank) : Type 1
2 : Type 2
3. Material:
(Blank): Nylon 66, UL94V-0
GWT: Nylon 66, UL94V-0, GWT 750°C
4. Finish:
(blank): Tin over Nickel
G: Gold over Nickel

Ordering Information & Dimensions:

PART NO.	Dimensions	
	A	B
2P	2.54	5.08
3P	5.08	7.62
4P	7.62	10.16
5P	10.16	12.70
6P	12.70	15.24
7P	15.24	17.78
8P	17.78	20.32
9P	20.32	22.86
10P	22.86	25.40
11P	25.40	27.94
12P	27.94	30.48
13P	30.48	33.02
14P	33.02	35.56
15P	35.56	38.10
16P	38.10	40.64
17P	40.64	43.18
18P	43.18	45.72
19P	45.72	48.26
20P	48.26	50.80
21P	50.80	53.34
22P	53.34	55.88
23P	55.88	58.42
24P	58.42	60.96
25P	60.96	63.50
26P	63.50	66.04
27P	66.04	68.58
28P	68.58	71.12

Unit: mm

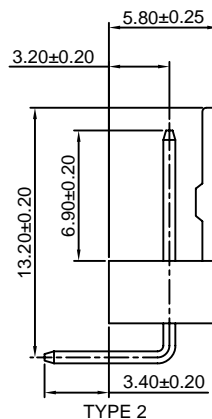
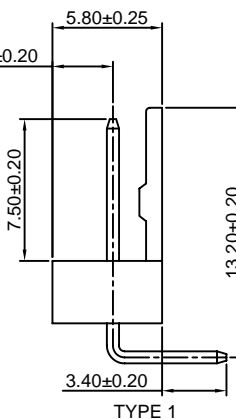
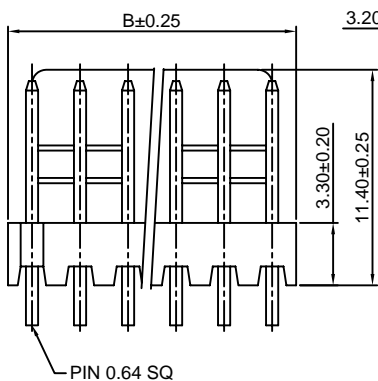
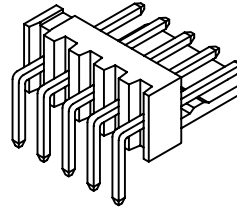
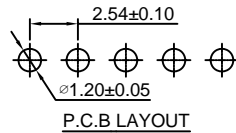
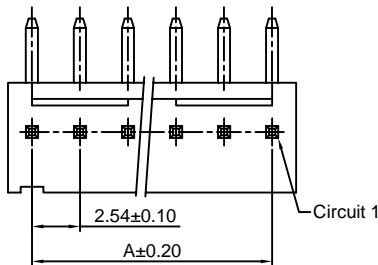

A2543WR-XP-L

— 2.54mm pitch 90° Wafer —

Reference Informations:

- *Material: Pin: Brass/Tin over Nickel
Insulator: Nylon 66, UL94V-0
- *Mates with CJT A2543H-XP series Housing
- *Color: Beige

Ordering Information:

A2543WR-XP-L - * - *** - **
1 2 3 4

1. Part No.
2. Style:
(blank) : Type 1
2 : Type 2
3. Material:
(Blank): Nylon 66, UL94V-0
GWT: Nylon 66, UL94V-0, GWT 750°C
4. Finish:
(blank): Tin over Nickel
G: Gold over Nickel

Ordering Information & Dimensions:

PART NO.	Dimensions	
	A	B
2P	2.54	5.08
3P	5.08	7.62
4P	7.62	10.16
5P	10.16	12.70
6P	12.70	15.24
7P	15.24	17.78
8P	17.78	20.32
9P	20.32	22.86
10P	22.86	25.40
11P	25.40	27.94
12P	27.94	30.48
13P	30.48	33.02
14P	33.02	35.56
15P	35.56	38.10
16P	38.10	40.64
17P	40.64	43.18
18P	43.18	45.72
19P	45.72	48.26
20P	48.26	50.80
21P	50.80	53.34
22P	53.34	55.88
23P	55.88	58.42
24P	58.42	60.96
25P	60.96	63.50
26P	63.50	66.04
27P	66.04	68.58
28P	68.58	71.12

Unit: mm

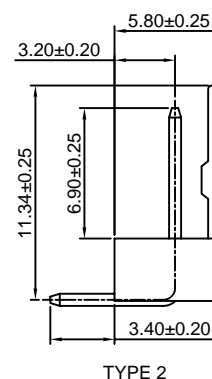
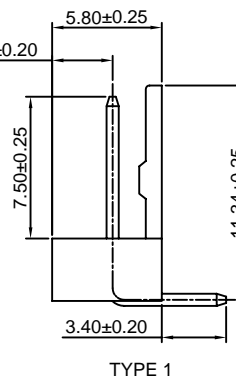
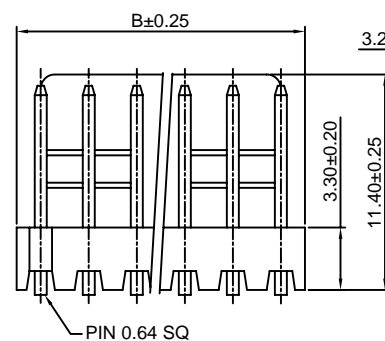
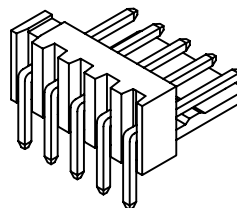
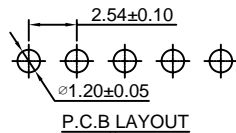
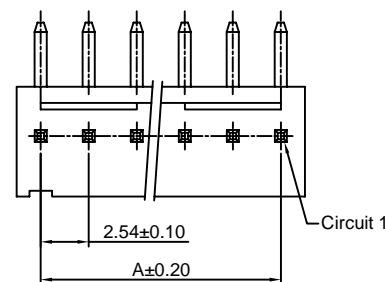

A2543WVA-XP-WH

2.54mm pitch 180° Wafer

Reference Informations:

- *Material: Pin: Brass/Tin over Nickel
Insulator: Nylon 66, UL94V-0
- *Mates with CJT A2543HA, HB-XP-WH series Housing
- *Color: White

Ordering Information:
A2543WVA-XP-WH - *** - **
1 2 3

1. Part No.
2. Material:
(Blank): Nylon 66, UL94V-0
GWT: Nylon 66, UL94V-0, GWT 750°C
3. Finish:
(blank): Tin over Nickel
G: Gold over Nickel

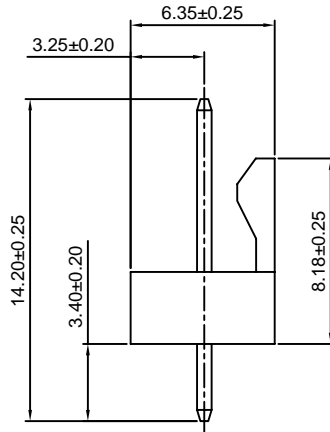
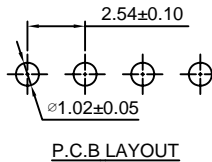
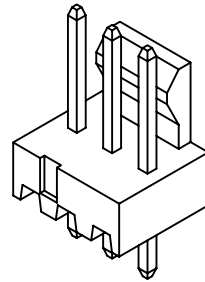
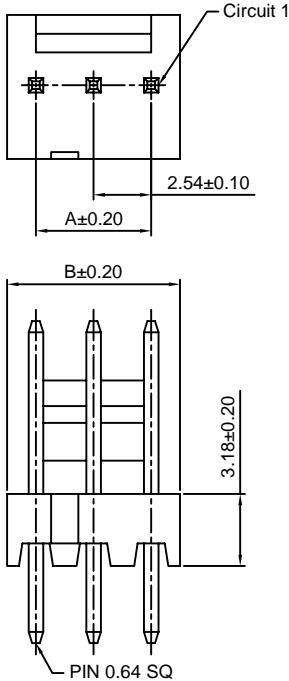

Ordering Information & Dimensions:

PART NO.	Dimensions	
	A	B
2P	2.54	5.08
3P	5.08	7.62
4P	7.62	10.16
5P	10.16	12.70
6P	12.70	15.24
7P	15.24	17.78
8P	17.78	20.32
9P	20.32	22.86
10P	22.86	25.40
11P	25.40	27.94
12P	27.94	30.48
13P	30.48	33.02
14P	33.02	35.56
15P	35.56	38.10
16P	38.10	40.64
17P	40.64	43.18
18P	43.18	45.72
19P	45.72	48.26
20P	48.26	50.80
21P	50.80	53.34
22P	53.34	55.88
23P	55.88	58.42
24P	58.42	60.96
25P	60.96	63.50
26P	63.50	66.04
27P	66.04	68.58
28P	68.58	71.12

Unit: mm

A2543WRA-XP-WH

2.54mm Pitch 90° Wafer

Reference Informations:

- *Material: Pin: Brass/Tin over Nickel
Insulator: Nylon 66, UL94V-0
- *Mates with CJT A2543HA, HB-XP-WH series Housing
- *Color: White

Ordering Information:
A2543WRA-XP-WH - * - *** - **
1 2 3 4

1. Part No.
2. Style:
(blank): Type 1
2: Type 2
3. Material:
(Blank): Nylon 66, UL94V-0
GWT: Nylon 66, UL94V-0, GWT 750°C
4. Finish:
(blank): Tin over Nickel
G: Gold over Nickel

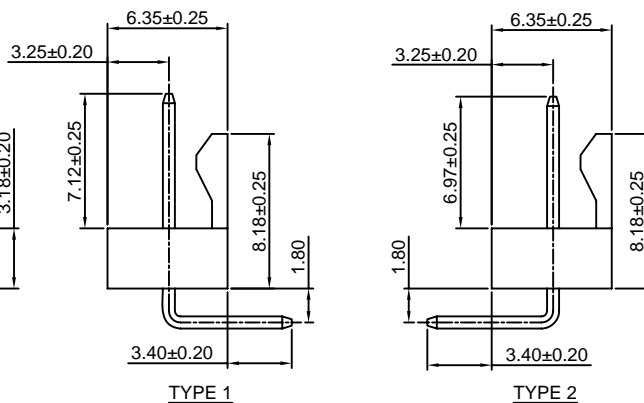
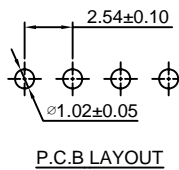
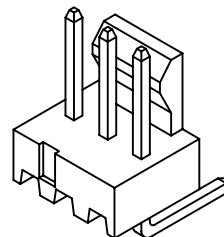
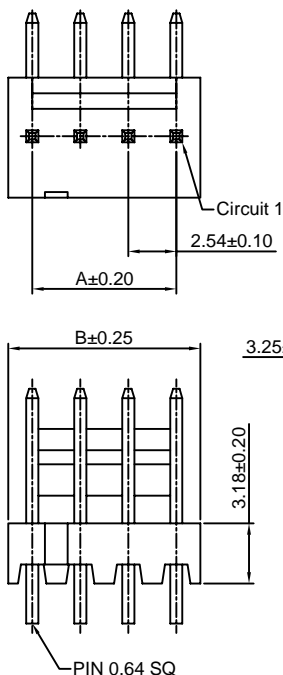

Ordering Information & Dimensions:

PART NO.	Dimensions	
	A	B
2P	2.54	5.08
3P	5.08	7.62
4P	7.62	10.16
5P	10.16	12.70
6P	12.70	15.24
7P	15.24	17.78
8P	17.78	20.32
9P	20.32	22.86
10P	22.86	25.40
11P	25.40	27.94
12P	27.94	30.48
13P	30.48	33.02
14P	33.02	35.56
15P	35.56	38.10
16P	38.10	40.64
17P	40.64	43.18
18P	43.18	45.72
19P	45.72	48.26
20P	48.26	50.80
21P	50.80	53.34
22P	53.34	55.88
23P	55.88	58.42
24P	58.42	60.96
25P	60.96	63.50
26P	63.50	66.04
27P	66.04	68.58
28P	68.58	71.12

Unit: mm

A2543WVC-4P

2.54mm pitch 180° Wafer

Reference Informations:

- *Material: Pin: Brass/Tin over Nickel
Insulator: Nylon 66, UL94V-0
- *Mates with CJT A2543HC-4P series Housing
- *Color: Beige

Ordering Information:

A2543WVC-4P - *** - **
1 2 3

1. Part No.
2. Material:
(Blank): Nylon 66, UL94V-0
GWT: Nylon 66, UL94V-0, GWT 750 °C
3. Finish:
(blank): Tin over Nickel
G: Gold over Nickel

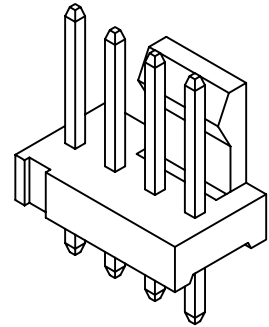
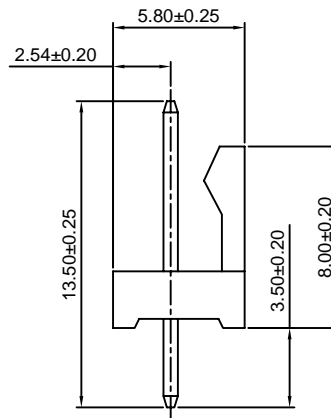
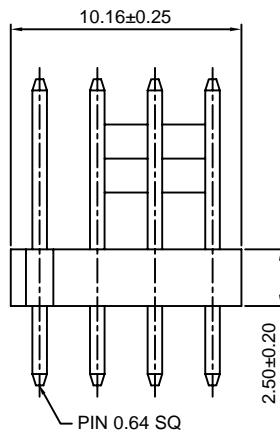
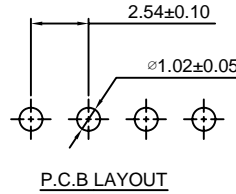
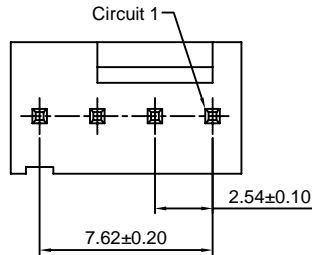

Unit: mm

A2543WRD-XP

2.54mm Pitch 90° Wafer

Reference Informations:

- *Material: Pin: Brass/Tin over Nickel
Insulator: Nylon 66, UL94V-0
- *Mates with CJT A2543HA, HB-XP-WH series Housing
- *Color: White

Ordering Information:

A2543WRD-XP - *** - **
1 2 3

1. Part No.
2. Material:
(Blank): Nylon 66, UL94V-0
GWT: Nylon 66, UL94V-0, GWT 750 °C
3. Finish:
(blank): Tin over Nickel
G: Gold over Nickel

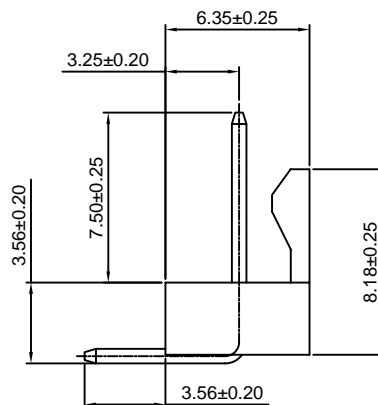
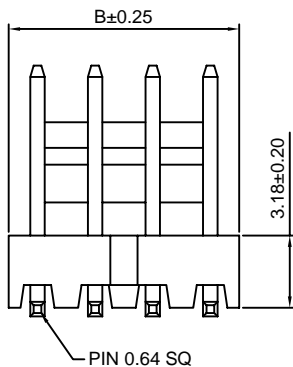
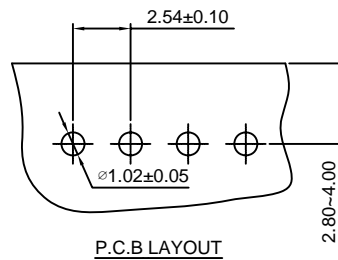
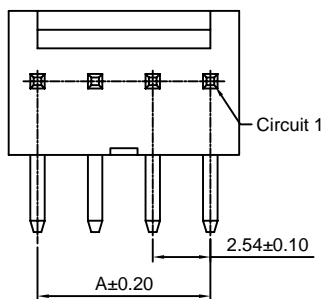

Ordering Information & Dimensions:

PART NO.	Dimensions	
	A	B
2P	2.54	5.08
3P	5.08	7.62
4P	7.62	10.16
5P	10.16	12.70
6P	12.70	15.24
7P	15.24	17.78
8P	17.78	20.32
9P	20.32	22.86
10P	22.86	25.40
11P	25.40	27.94
12P	27.94	30.48
13P	30.48	33.02
14P	33.02	35.56
15P	35.56	38.10
16P	38.10	40.64
17P	40.64	43.18
18P	43.18	45.72
19P	45.72	48.26
20P	48.26	50.80

Unit: mm

A2543WR-S-XP

2.54mm Pitch 90° Wafer - SMT TYPE

Reference Informations:

- *Material:Pin:Brass/Tin over Nickel
Insulator:Nylon 9T,UL94V-0
- *Mates with CJT A2543H-XP series Housing
- *Color:Natural

Ordering Information:

A2543WR-S-XP - *** - **
1 2 3

- 1.Part No.
- 2.Material:
(Blank):Nylon 9T,UL94V-0
GWT:Nylon 9T,UL94V-0,GWT 750 °C
- 3.Finish:
(blank):Tin over Nickel
G:Gold over Nickel

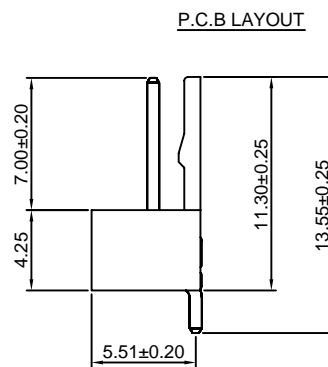
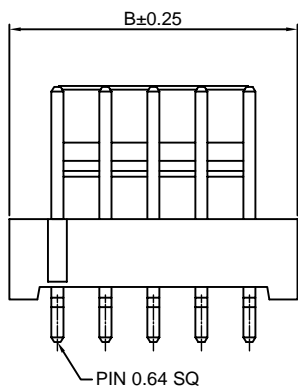
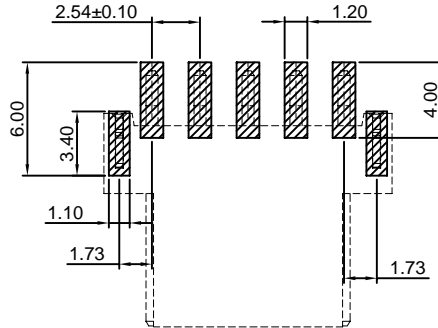
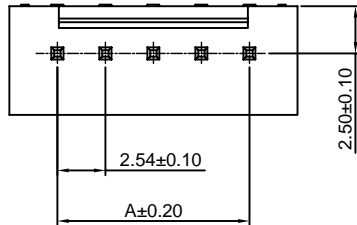

Ordering Information & Dimensions:

PART NO.	Dimensions	
	A	B
2P	2.54	7.62
4P	7.62	12.70
5P	10.16	15.24

Unit: mm

A2543WVB-S-XP

2.54mm pitch 180° Wafer - SMT TYPE

Reference Informations:

- *Material:Pin:Brass/Tin over Nickel
Insulator:LCP,UL94V-0
- *Mates with CJT A2543HA,HB-XP-WH series Housing
- *Color:Ivory

Ordering Information:

A2543WVB-S-XP - *** - ** - *
1 2 3 4

- 1.Part No.
- 2.Material:
(Blank):LCP,UL94V-0
GWT:LCP,UL94V-0,GWT 750 °C
- 3.Color:
(blank):Ivory
BK:Black
- 4.Finish:
(blank):Tin over Nickel
G:Gold over Nickel

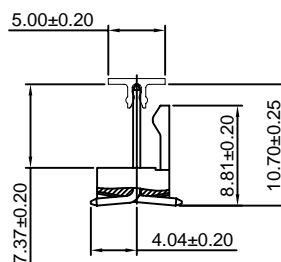
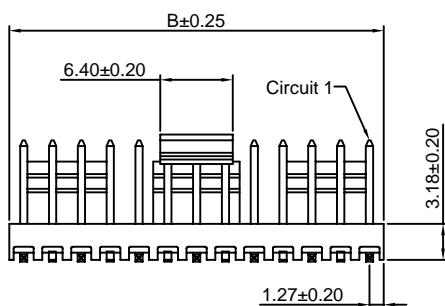
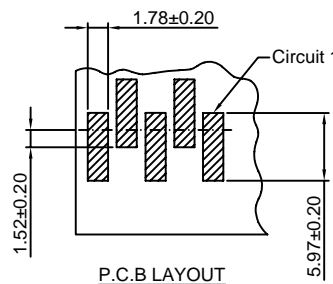
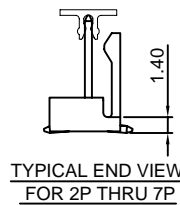
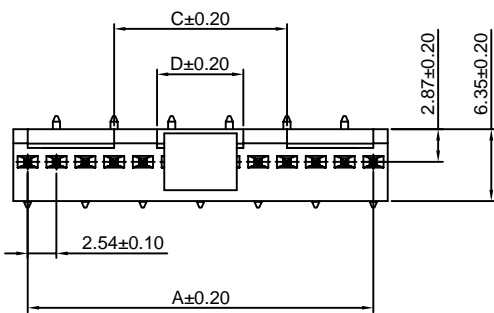

Ordering Information & Dimensions:

PART NO.	Dimensions			
	A	B	C	D
2P	2.54	5.08	----	----
3P	5.08	7.62	----	----
4P	7.62	10.16	----	----
5P	10.16	12.70	----	----
6P	12.70	15.24	----	----
7P	15.24	17.78	----	----
8P	17.78	20.32	2.54	----
9P	20.32	22.86	5.08	----
10P	22.86	25.40	7.62	----
11P	25.40	27.94	10.16	----
12P	27.94	30.48	12.70	7.62
13P	30.48	33.02	15.24	7.62
14P	33.02	35.56	17.78	12.70
15P	35.56	38.10	20.32	12.70
16P	38.10	40.64	22.86	12.70
17P	40.64	43.18	25.40	12.70
18P	43.18	45.72	27.94	12.70

Unit: mm

X-ON Electronics

Largest Supplier of Electrical and Electronic Components

Click to view similar products for [Headers & Wire Housings](#) category:

Click to view products by [Changjiang](#) manufacturer:

Other Similar products are found below :

[95000-104TRLF](#) [10135584-644402LF](#) [DF62W-EP2022PCA](#) [95000-106TRLF](#) [DF62W-2022SCA](#) [DF62W-EP2022PC](#) [2203348](#) [DF62W-2022SC](#) [1084018](#) [1029039](#) [1084017](#) [802-10-012-10-002000](#) [1112640](#) [1112639](#) [891-007-9SS-BST1T](#) [000-34000](#) [0008550134](#) [0009482033](#) [0009507031](#) [57102-F02-18ULF](#) [57102-S06-03LF](#) [57202-S52-04LF](#) [PCN6-15S-2.5E](#) [0039019024](#) [58102-G61-06LF](#) [582553-1](#) [0009485154](#) [0009508121](#) [0022285053](#) [0050291907](#) [018731A](#) [LY20-4P-DT1-P1E-BR](#) [02.125.8002.8](#) [60101931](#) [60598-1 \(Cut Strip\)](#) [M1625-3R/100](#) [61062-3](#) [61082-181009](#) [CSU011177004](#) [636-1427](#) [638009-1](#) [641938-9](#) [641991-4](#) [644168-1](#) [644827-2](#) [647662-1](#) [65039-019ELF](#) [65692-001LF](#) [65781-018](#) [65781-047](#)