

Specifications

- Current rating:4A AC,DC
- Voltage rating:250V AC,DC
- Temperature range:-40°C~+105°C
- Contact resistance:10mΩMax.
- Insulation resistance:1000MΩMin.
- Withstanding voltage:1000V AC/minute
- *Compliant with RoHS and REACH*
- *Meet the HF/Halogen Free,need to customize*
- *Contact CJT for details*

Standards



Assembly layout

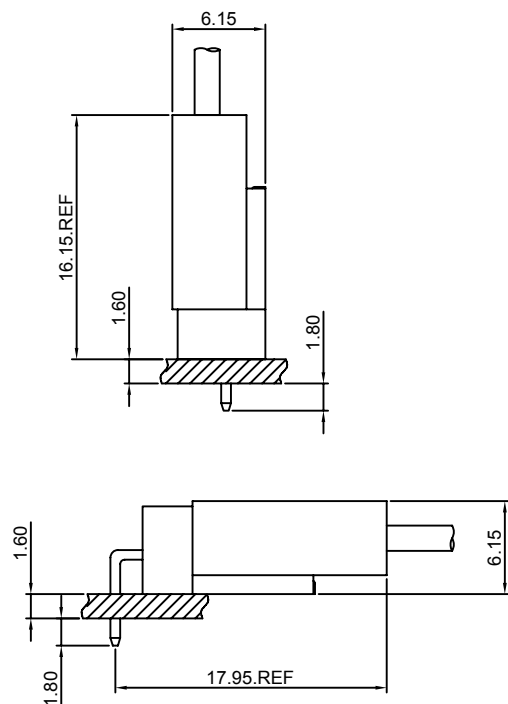
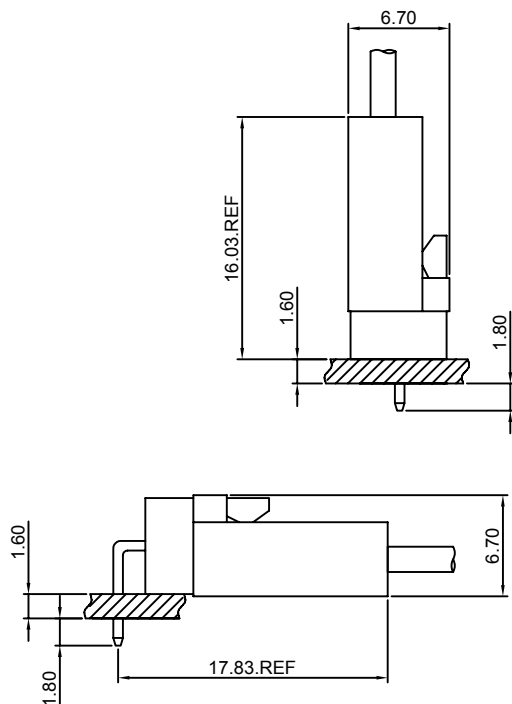

A2543-T

2.54mm Pitch Crimp Terminal

Reference Informations:

*Used in CJT A2543H-XP, A2543HA, HB-XP-WH, A2543HC-4P, C2504AH-XP series Housing

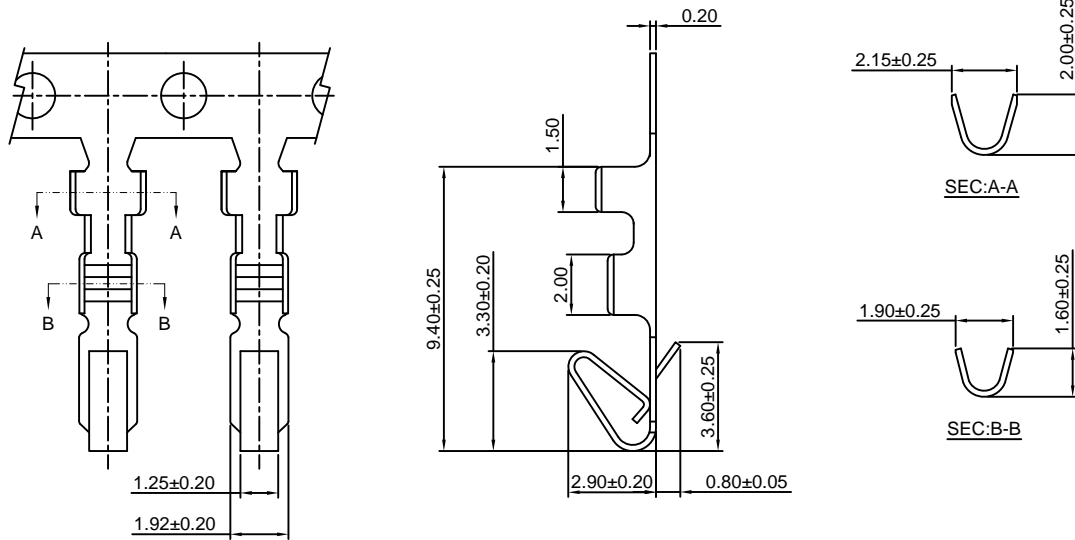

Ordering information & Specifications:

Unit:mm

| Part NO. | Wire Range | Insulation O.D. | Material | Finish | Qty/reel |
|----------|------------|-----------------|-----------------|------------------|------------|
| A2543-TB | AWG#22-#28 | 1.90mm(max) | Brass | Tin over Nickel | 10,000 PCS |
| A2543-TP | AWG#22-#28 | 1.90mm(max) | Phosphor Bronze | Tin over Nickel | 10,000 PCS |
| A2543-GB | AWG#22-#28 | 1.90mm(max) | Brass | Gold over Nickel | 10,000 PCS |
| A2543-GP | AWG#22-#28 | 1.90mm(max) | Phosphor Bronze | Gold over Nickel | 10,000 PCS |

Optional Gold plating available but MOQ requested

A2543H-XP

2.54mm Pitch Housing

Reference Informations:

*Material:Nylon 66,UL94V-0

*Suitable CJT A2543-T series Terminal

*Mates with CJT A2543WV, WR-XP, A2543WR-XP-L,

A2543WR-S-XP series Wafer

*Color:Beige or White

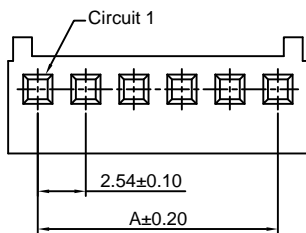

Ordering Information:

A2543H-XP - * - ***
1 2 3

1.Part No.

2.Style:
(blank) :Type 1/Beige
2 :Type 2/White

3.Material:
(Blank):Nylon 66,UL94V-0
GWT:Nylon 66,UL94V-0,GWT 750 °C

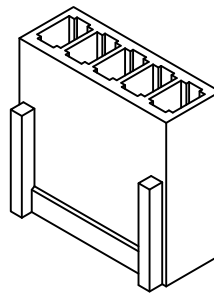

Ordering Information & Dimensions:

| PART NO. | Dimensions | |
|----------|------------|-------|
| | A | B |
| 2P | 2.54 | 5.68 |
| 3P | 5.08 | 8.22 |
| 4P | 7.62 | 10.76 |
| 5P | 10.16 | 13.30 |
| 6P | 12.70 | 15.84 |
| 7P | 15.24 | 18.38 |
| 8P | 17.78 | 20.92 |
| 9P | 20.32 | 23.46 |
| 10P | 22.86 | 26.00 |
| 11P | 25.40 | 28.54 |
| 12P | 27.94 | 31.08 |
| 13P | 30.48 | 33.62 |
| 14P | 33.02 | 36.16 |
| 15P | 35.56 | 38.70 |
| 16P | 38.10 | 41.24 |
| 17P | 40.64 | 43.78 |
| 18P | 43.18 | 46.32 |
| 19P | 45.72 | 48.86 |
| 20P | 48.26 | 51.40 |
| 21P | 50.80 | 53.94 |
| 22P | 53.34 | 56.48 |
| 23P | 55.88 | 59.02 |
| 24P | 58.42 | 61.56 |
| 25P | 60.96 | 64.10 |

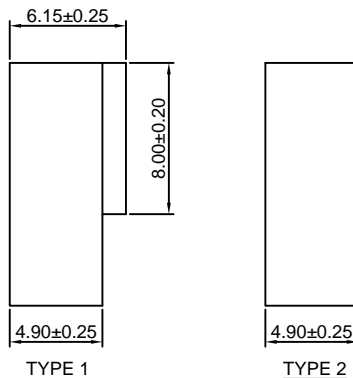
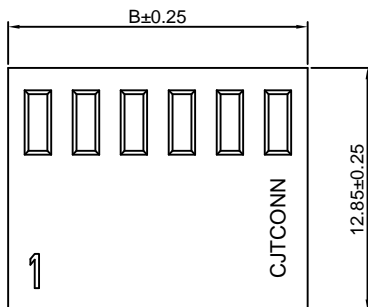

Unit: mm

A2543HC-4P

2.54mm Pitch Housing

Reference Informations:

- *Material:Nylon 66,UL94V-0
- *Suitable CJT A2543-T series Terminal
- *Mates with CJT A2543WVC-4P series Wafer
- *Color:Beige

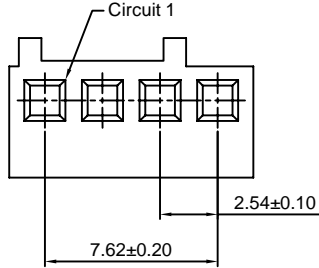

Ordering Information:

- A2543H-4P - ***
 1 2
- 1.Part No.
 2.Material:
 (Blank):Nylon 66,UL94V-0
 GWT:Nylon 66,UL94V-0,GWT 750 °C

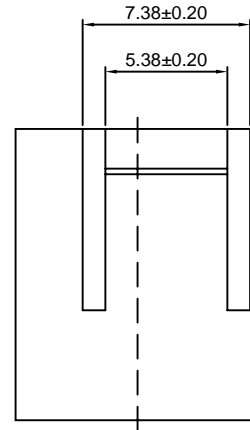
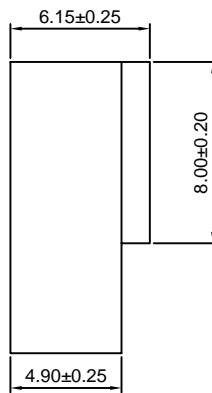
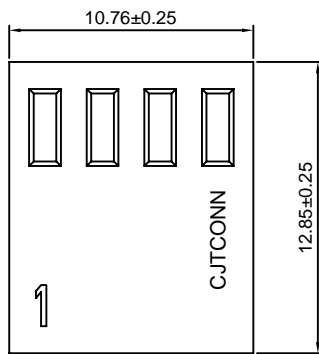
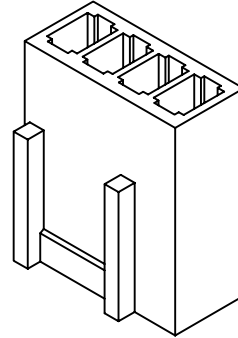

Unit: mm

A2543WV-XP

2.54mm pitch 180° Wafer

Reference Informations:

- *Material:Pin:Brass/Tin over Nickel
 Insulator:Nylon 66,UL94V-0
- *Mates with CJT A2543H-XP series Housing
- *Color:Beige

Ordering Information:

- A2543WV-XP - *** - **
 1 2 3
- 1.Part No.
 2.Material:
 (Blank):Nylon 66,UL94V-0
 GWT:Nylon 66,UL94V-0,GWT 750 °C
- 3.Finish:
 (blank):Tin over Nickel
 G:Gold over Nickel

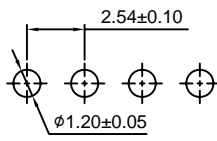
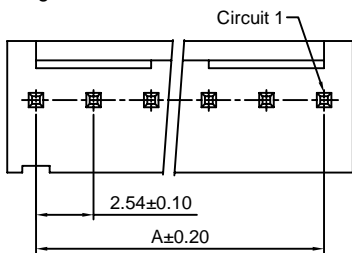

P.C.B LAYOUT

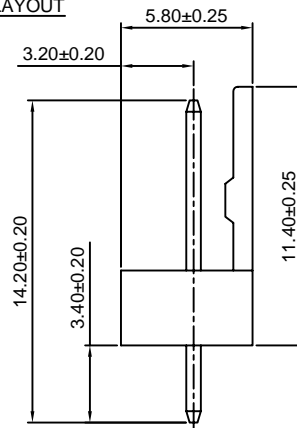
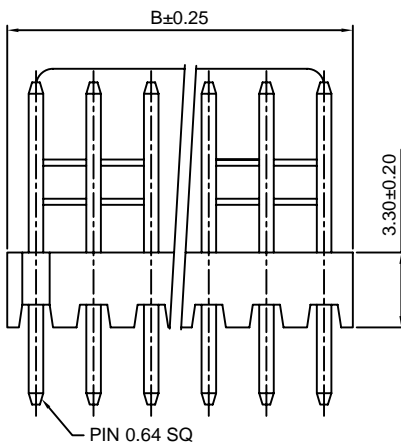
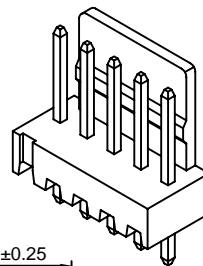

Ordering Information & Dimensions:

| PART NO. | Dimensions | |
|----------|------------|-------|
| | A | B |
| 2P | 2.54 | 5.08 |
| 3P | 5.08 | 7.62 |
| 4P | 7.62 | 10.16 |
| 5P | 10.16 | 12.70 |
| 6P | 12.70 | 15.24 |
| 7P | 15.24 | 17.78 |
| 8P | 17.78 | 20.32 |
| 9P | 20.32 | 22.86 |
| 10P | 22.86 | 25.40 |
| 11P | 25.40 | 27.94 |
| 12P | 27.94 | 30.48 |
| 13P | 30.48 | 33.02 |
| 14P | 33.02 | 35.56 |
| 15P | 35.56 | 38.10 |
| 16P | 38.10 | 40.64 |
| 17P | 40.64 | 43.18 |
| 18P | 43.18 | 45.72 |
| 19P | 45.72 | 48.26 |
| 20P | 48.26 | 50.80 |
| 21P | 50.80 | 53.34 |
| 22P | 53.34 | 55.88 |
| 23P | 55.88 | 58.42 |
| 24P | 58.42 | 60.96 |
| 25P | 60.96 | 63.50 |
| 26P | 63.50 | 66.04 |
| 27P | 66.04 | 68.58 |
| 28P | 68.58 | 71.12 |

Unit: mm

A2543WR-XP

2.54mm pitch 90° Wafer

Reference Informations:

- *Material:Pin:Brass/Tin over Nickel
Insulator:Nylon 66,UL94V-0
- *Mates with CJT A2543H-XP series Housing
- *Color:Beige

Ordering Information:

A2543WR-XP - * - *** - **
1 2 3 4

- Part No.
- Style:
(blank) :Type 1
2 :Type 2
- Material:
(Blank):Nylon 66,UL94V-0
GWT:Nylon 66,UL94V-0,GWT 750°C
- Finish:
(blank):Tin over Nickel
G:Gold over Nickel

Ordering Information & Dimensions:

| PART NO. | Dimensions | |
|----------|------------|-------|
| | A | B |
| 2P | 2.54 | 5.08 |
| 3P | 5.08 | 7.62 |
| 4P | 7.62 | 10.16 |
| 5P | 10.16 | 12.70 |
| 6P | 12.70 | 15.24 |
| 7P | 15.24 | 17.78 |
| 8P | 17.78 | 20.32 |
| 9P | 20.32 | 22.86 |
| 10P | 22.86 | 25.40 |
| 11P | 25.40 | 27.94 |
| 12P | 27.94 | 30.48 |
| 13P | 30.48 | 33.02 |
| 14P | 33.02 | 35.56 |
| 15P | 35.56 | 38.10 |
| 16P | 38.10 | 40.64 |
| 17P | 40.64 | 43.18 |
| 18P | 43.18 | 45.72 |
| 19P | 45.72 | 48.26 |
| 20P | 48.26 | 50.80 |
| 21P | 50.80 | 53.34 |
| 22P | 53.34 | 55.88 |
| 23P | 55.88 | 58.42 |
| 24P | 58.42 | 60.96 |
| 25P | 60.96 | 63.50 |
| 26P | 63.50 | 66.04 |
| 27P | 66.04 | 68.58 |
| 28P | 68.58 | 71.12 |

Unit: mm

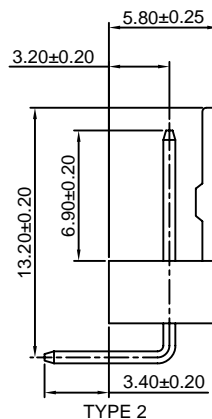
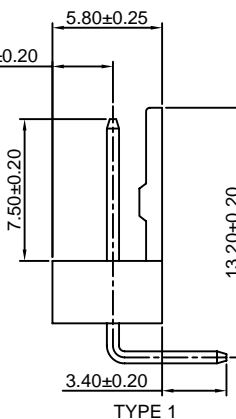
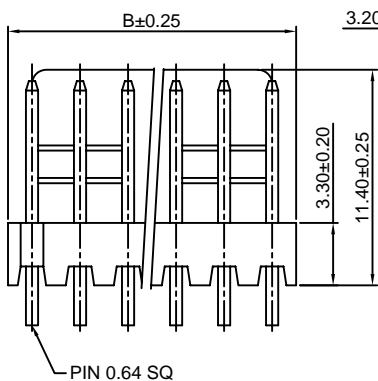
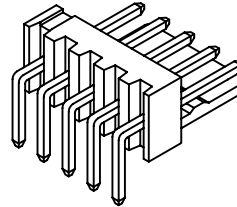
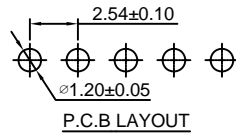
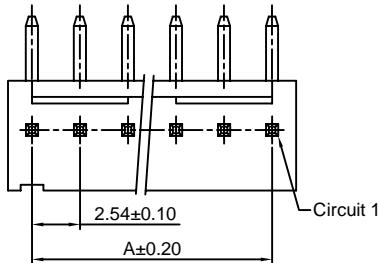

A2543WR-XP-L

2.54mm pitch 90° Wafer

Reference Informations:

- *Material:Pin:Brass/Tin over Nickel
Insulator:Nylon 66,UL94V-0
- *Mates with CJT A2543H-XP series Housing
- *Color:Beige

Ordering Information:

A2543WR-XP-L - * - *** - **
1 2 3 4

- Part No.
- Style:
(blank) :Type 1
2 :Type 2
- Material:
(Blank):Nylon 66,UL94V-0
GWT:Nylon 66,UL94V-0,GWT 750°C
- Finish:
(blank):Tin over Nickel
G:Gold over Nickel

Ordering Information & Dimensions:

| PART NO. | Dimensions | |
|----------|------------|-------|
| | A | B |
| 2P | 2.54 | 5.08 |
| 3P | 5.08 | 7.62 |
| 4P | 7.62 | 10.16 |
| 5P | 10.16 | 12.70 |
| 6P | 12.70 | 15.24 |
| 7P | 15.24 | 17.78 |
| 8P | 17.78 | 20.32 |
| 9P | 20.32 | 22.86 |
| 10P | 22.86 | 25.40 |
| 11P | 25.40 | 27.94 |
| 12P | 27.94 | 30.48 |
| 13P | 30.48 | 33.02 |
| 14P | 33.02 | 35.56 |
| 15P | 35.56 | 38.10 |
| 16P | 38.10 | 40.64 |
| 17P | 40.64 | 43.18 |
| 18P | 43.18 | 45.72 |
| 19P | 45.72 | 48.26 |
| 20P | 48.26 | 50.80 |
| 21P | 50.80 | 53.34 |
| 22P | 53.34 | 55.88 |
| 23P | 55.88 | 58.42 |
| 24P | 58.42 | 60.96 |
| 25P | 60.96 | 63.50 |
| 26P | 63.50 | 66.04 |
| 27P | 66.04 | 68.58 |
| 28P | 68.58 | 71.12 |

Unit: mm

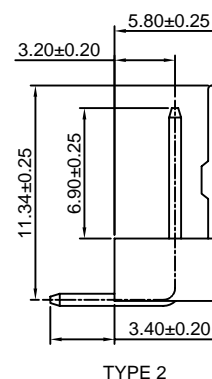
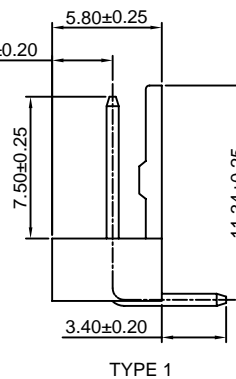
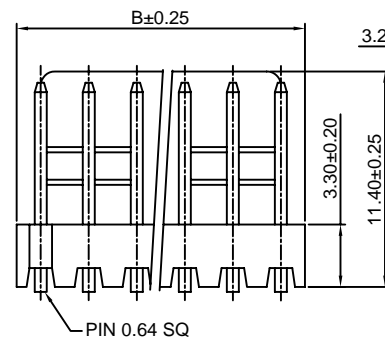
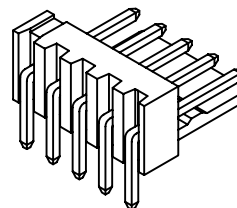
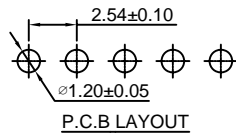
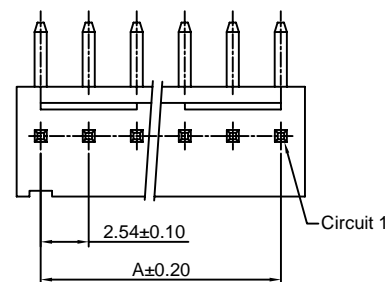

A2543WVA-XP-WH

2.54mm pitch 180° Wafer

Reference Informations:

- *Material: Pin: Brass/Tin over Nickel
Insulator: Nylon 66, UL94V-0
- *Mates with CJT A2543HA, HB-XP-WH series Housing
- *Color: White

Ordering Information:
A2543WVA-XP-WH - *** - **
1 2 3

1. Part No.
2. Material:
(Blank): Nylon 66, UL94V-0
GWT: Nylon 66, UL94V-0, GWT 750°C
3. Finish:
(blank): Tin over Nickel
G: Gold over Nickel

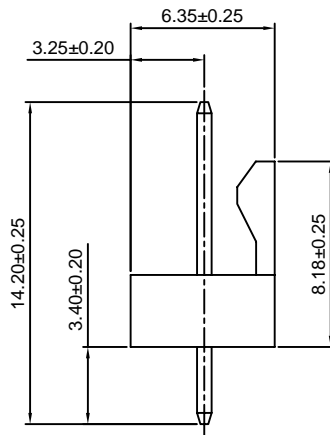
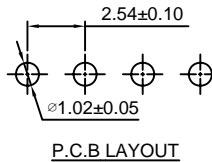
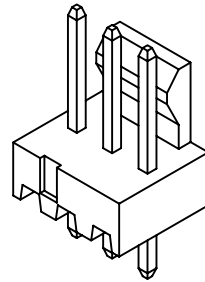
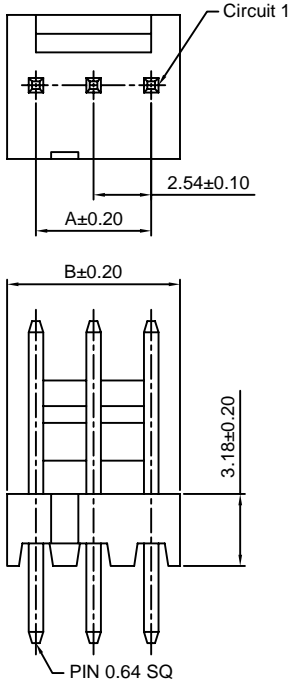

Ordering Information & Dimensions:

| PART NO. | Dimensions | |
|----------|------------|-------|
| | A | B |
| 2P | 2.54 | 5.08 |
| 3P | 5.08 | 7.62 |
| 4P | 7.62 | 10.16 |
| 5P | 10.16 | 12.70 |
| 6P | 12.70 | 15.24 |
| 7P | 15.24 | 17.78 |
| 8P | 17.78 | 20.32 |
| 9P | 20.32 | 22.86 |
| 10P | 22.86 | 25.40 |
| 11P | 25.40 | 27.94 |
| 12P | 27.94 | 30.48 |
| 13P | 30.48 | 33.02 |
| 14P | 33.02 | 35.56 |
| 15P | 35.56 | 38.10 |
| 16P | 38.10 | 40.64 |
| 17P | 40.64 | 43.18 |
| 18P | 43.18 | 45.72 |
| 19P | 45.72 | 48.26 |
| 20P | 48.26 | 50.80 |
| 21P | 50.80 | 53.34 |
| 22P | 53.34 | 55.88 |
| 23P | 55.88 | 58.42 |
| 24P | 58.42 | 60.96 |
| 25P | 60.96 | 63.50 |
| 26P | 63.50 | 66.04 |
| 27P | 66.04 | 68.58 |
| 28P | 68.58 | 71.12 |

Unit: mm

A2543WRA-XP-WH

2.54mm Pitch 90° Wafer

Reference Informations:

- *Material: Pin: Brass/Tin over Nickel
Insulator: Nylon 66, UL94V-0
- *Mates with CJT A2543HA, HB-XP-WH series Housing
- *Color: White

Ordering Information:
A2543WRA-XP-WH - * - *** - **
1 2 3 4

1. Part No.
2. Style:
(blank): Type 1
2: Type 2
3. Material:
(Blank): Nylon 66, UL94V-0
GWT: Nylon 66, UL94V-0, GWT 750°C
4. Finish:
(blank): Tin over Nickel
G: Gold over Nickel

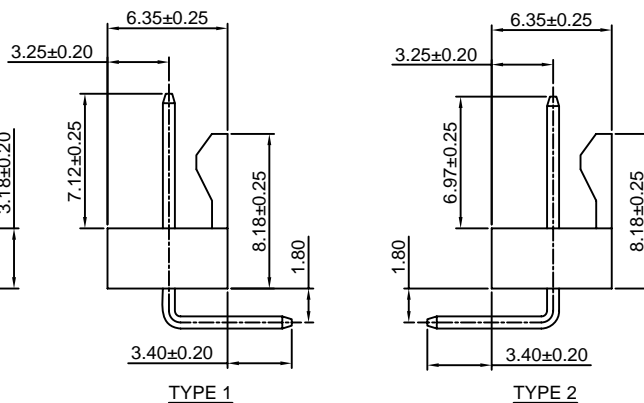
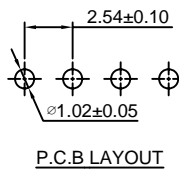
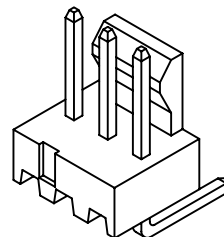
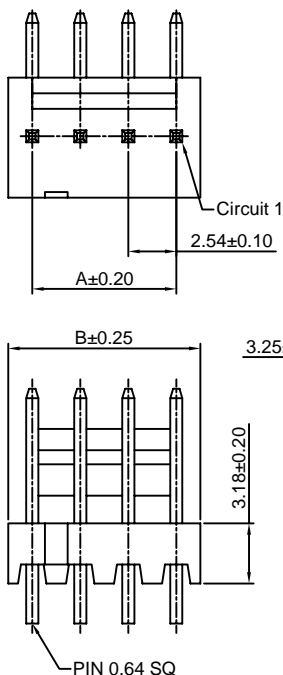

Ordering Information & Dimensions:

| PART NO. | Dimensions | |
|----------|------------|-------|
| | A | B |
| 2P | 2.54 | 5.08 |
| 3P | 5.08 | 7.62 |
| 4P | 7.62 | 10.16 |
| 5P | 10.16 | 12.70 |
| 6P | 12.70 | 15.24 |
| 7P | 15.24 | 17.78 |
| 8P | 17.78 | 20.32 |
| 9P | 20.32 | 22.86 |
| 10P | 22.86 | 25.40 |
| 11P | 25.40 | 27.94 |
| 12P | 27.94 | 30.48 |
| 13P | 30.48 | 33.02 |
| 14P | 33.02 | 35.56 |
| 15P | 35.56 | 38.10 |
| 16P | 38.10 | 40.64 |
| 17P | 40.64 | 43.18 |
| 18P | 43.18 | 45.72 |
| 19P | 45.72 | 48.26 |
| 20P | 48.26 | 50.80 |
| 21P | 50.80 | 53.34 |
| 22P | 53.34 | 55.88 |
| 23P | 55.88 | 58.42 |
| 24P | 58.42 | 60.96 |
| 25P | 60.96 | 63.50 |
| 26P | 63.50 | 66.04 |
| 27P | 66.04 | 68.58 |
| 28P | 68.58 | 71.12 |

Unit: mm

A2543WVC-4P

2.54mm pitch 180° Wafer

Reference Informations:

- *Material: Pin: Brass/Tin over Nickel
Insulator: Nylon 66, UL94V-0
- *Mates with CJT A2543HC-4P series Housing
- *Color: Beige

Ordering Information:

A2543WVC-4P - *** - **
1 2 3

1. Part No.
2. Material:
(Blank): Nylon 66, UL94V-0
GWT: Nylon 66, UL94V-0, GWT 750 °C
3. Finish:
(blank): Tin over Nickel
G: Gold over Nickel

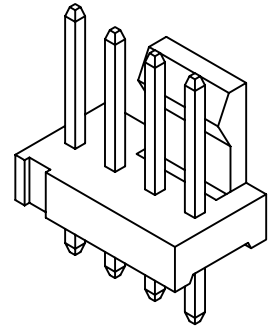
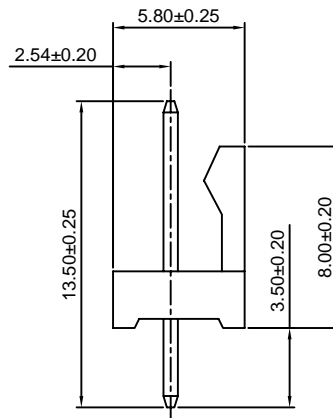
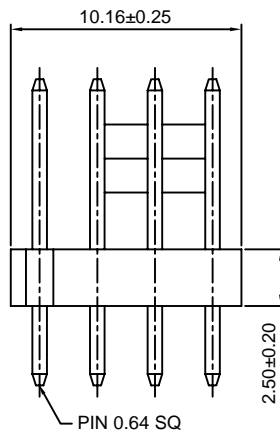
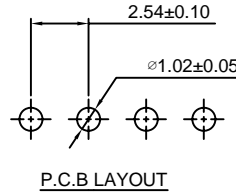
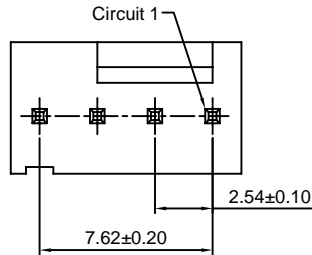

Unit: mm

A2543WRD-XP

2.54mm Pitch 90° Wafer

Reference Informations:

- *Material: Pin: Brass/Tin over Nickel
Insulator: Nylon 66, UL94V-0
- *Mates with CJT A2543HA, HB-XP-WH series Housing
- *Color: White

Ordering Information:

A2543WRD-XP - *** - **
1 2 3

1. Part No.
2. Material:
(Blank): Nylon 66, UL94V-0
GWT: Nylon 66, UL94V-0, GWT 750 °C
3. Finish:
(blank): Tin over Nickel
G: Gold over Nickel

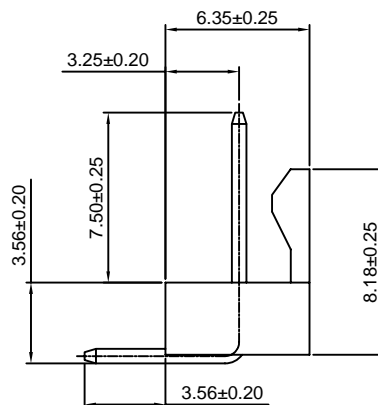
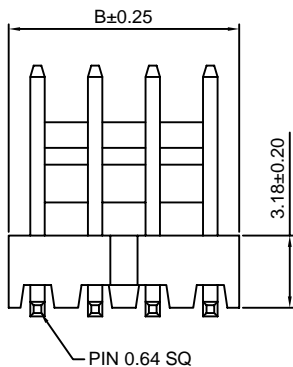
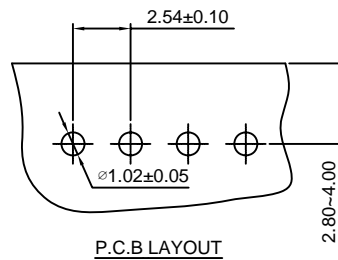
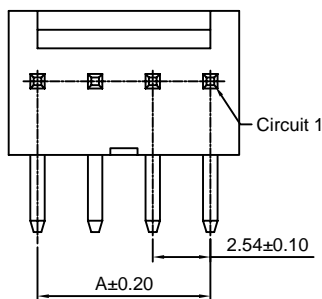

Ordering Information & Dimensions:

| PART NO. | Dimensions | |
|----------|------------|-------|
| | A | B |
| 2P | 2.54 | 5.08 |
| 3P | 5.08 | 7.62 |
| 4P | 7.62 | 10.16 |
| 5P | 10.16 | 12.70 |
| 6P | 12.70 | 15.24 |
| 7P | 15.24 | 17.78 |
| 8P | 17.78 | 20.32 |
| 9P | 20.32 | 22.86 |
| 10P | 22.86 | 25.40 |
| 11P | 25.40 | 27.94 |
| 12P | 27.94 | 30.48 |
| 13P | 30.48 | 33.02 |
| 14P | 33.02 | 35.56 |
| 15P | 35.56 | 38.10 |
| 16P | 38.10 | 40.64 |
| 17P | 40.64 | 43.18 |
| 18P | 43.18 | 45.72 |
| 19P | 45.72 | 48.26 |
| 20P | 48.26 | 50.80 |

Unit: mm

A2543WR-S-XP

2.54mm Pitch 90° Wafer - SMT TYPE

Reference Informations:

- *Material: Pin: Brass/Tin over Nickel
Insulator: Nylon 9T, UL94V-0
- *Mates with CJT A2543H-XP series Housing
- *Color: Natural

Ordering Information:

A2543WR-S-XP - *** - **
1 2 3

- Part No.
- Material:
(Blank): Nylon 9T, UL94V-0
GWT: Nylon 9T, UL94V-0, GWT 750 °C
- Finish:
(blank): Tin over Nickel
G: Gold over Nickel

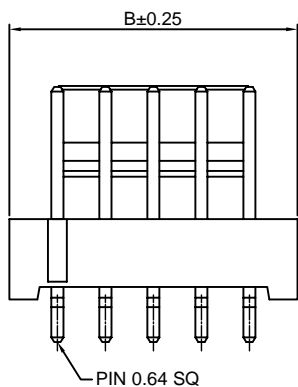
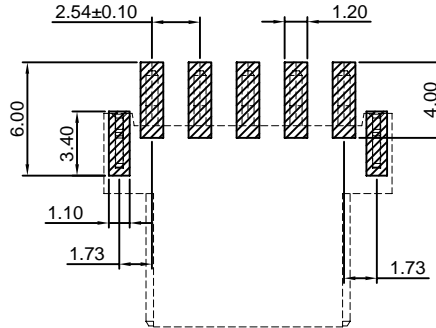
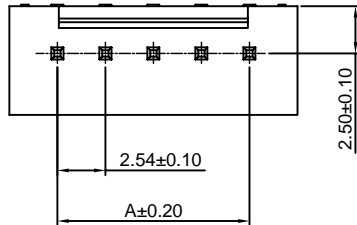

P.C.B LAYOUT

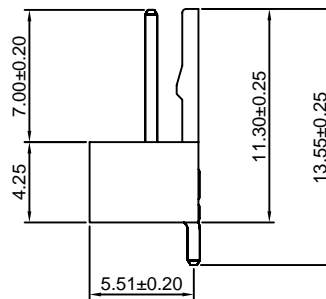

Ordering Information & Dimensions:

| PART NO. | Dimensions | |
|----------|------------|-------|
| | A | B |
| 2P | 2.54 | 7.62 |
| 4P | 7.62 | 12.70 |
| 5P | 10.16 | 15.24 |

Unit: mm

A2543WVB-S-XP

2.54mm pitch 180° Wafer - SMT TYPE

Reference Informations:

- *Material: Pin: Brass/Tin over Nickel
Insulator: LCP, UL94V-0
- *Mates with CJT A2543HA, HB-XP-WH series Housing
- *Color: Ivory

Ordering Information:

A2543WVB-S-XP - *** - ** - *
1 2 3 4

- Part No.
- Material:
(Blank): LCP, UL94V-0
GWT: LCP, UL94V-0, GWT 750 °C
- Color:
(blank): Ivory
BK: Black
- Finish:
(blank): Tin over Nickel
G: Gold over Nickel

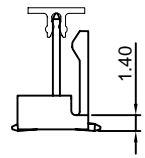
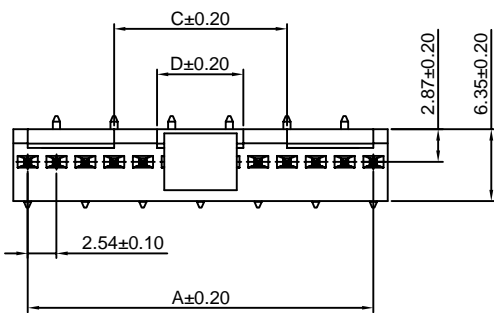

TYPICAL END VIEW FOR 2P THRU 7P

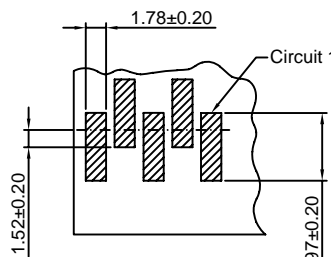

P.C.B LAYOUT

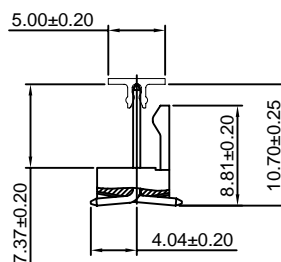
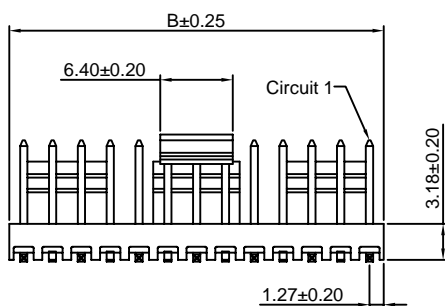

Ordering Information & Dimensions:

| PART NO. | Dimensions | | | |
|----------|------------|-------|-------|-------|
| | A | B | C | D |
| 2P | 2.54 | 5.08 | ---- | ---- |
| 3P | 5.08 | 7.62 | ---- | ---- |
| 4P | 7.62 | 10.16 | ---- | ---- |
| 5P | 10.16 | 12.70 | ---- | ---- |
| 6P | 12.70 | 15.24 | ---- | ---- |
| 7P | 15.24 | 17.78 | ---- | ---- |
| 8P | 17.78 | 20.32 | 2.54 | ---- |
| 9P | 20.32 | 22.86 | 5.08 | ---- |
| 10P | 22.86 | 25.40 | 7.62 | ---- |
| 11P | 25.40 | 27.94 | 10.16 | ---- |
| 12P | 27.94 | 30.48 | 12.70 | 7.62 |
| 13P | 30.48 | 33.02 | 15.24 | 7.62 |
| 14P | 33.02 | 35.56 | 17.78 | 12.70 |
| 15P | 35.56 | 38.10 | 20.32 | 12.70 |
| 16P | 38.10 | 40.64 | 22.86 | 12.70 |
| 17P | 40.64 | 43.18 | 25.40 | 12.70 |
| 18P | 43.18 | 45.72 | 27.94 | 12.70 |

Unit: mm

X-ON Electronics

Largest Supplier of Electrical and Electronic Components

Click to view similar products for [Terminals](#) category:

Click to view products by [Changjiang](#) manufacturer:

Other Similar products are found below :

[HT-13-10](#) [71M-250-32-NB](#) [01-2065-1-0216](#) [00581P0075](#) [M10-10RX](#) [M10BCK](#) [60205-1](#) [604200-1](#) [60598-1-CUT-TAPE](#) [60617-1-C](#) [60873-1](#) [M14-516R/SK](#) [M14-6RSX](#) [M18-10FLX](#) [M18-8FBX](#) [M18-8R/LX](#) [M18BCK](#) [61314-6-C](#) [61-S](#) [61-SN-A](#) [62149-1](#) [62-NBM-A](#) [63-S](#) [640179-1](#) [640917-2-CUT-TAPE](#) [6501550002](#) [66107-2-C](#) [66107-4-C](#) [696683-1](#) [696834-1](#) [696861-1](#) [696931-1](#) [696999-1](#) [M8-516RK](#) [M86700006](#) [MA250DMFMX-A](#) [701-2007](#) [701-2307](#) [701-7761-03](#) [70F-110-32-PB](#) [718-N-A](#) [71M-187-20-NBL](#) [71M-250-32-NBL](#) [72F-187-20-NBL](#) [72M-250-32-NBL](#) [7310](#) [73F-250-32](#) [73F-250-32-NBL](#) [73F-250-32-NL](#) [F14-10C](#)