

Specifications

- Current rating:3A AC,DC
- Voltage rating:250V AC,DC
- Temperature range:-40°C~+105°C
- Contact resistance:20mΩ Max.
- Insulation resistance:1000MΩ Min.
- Withstanding voltage:1500V AC/minute
- *Compliant with RoHS and REACH*
- *Meet the HF/Halogen Free,need to customize*
- *Contact CJT for details*

Standards



Assembly layout

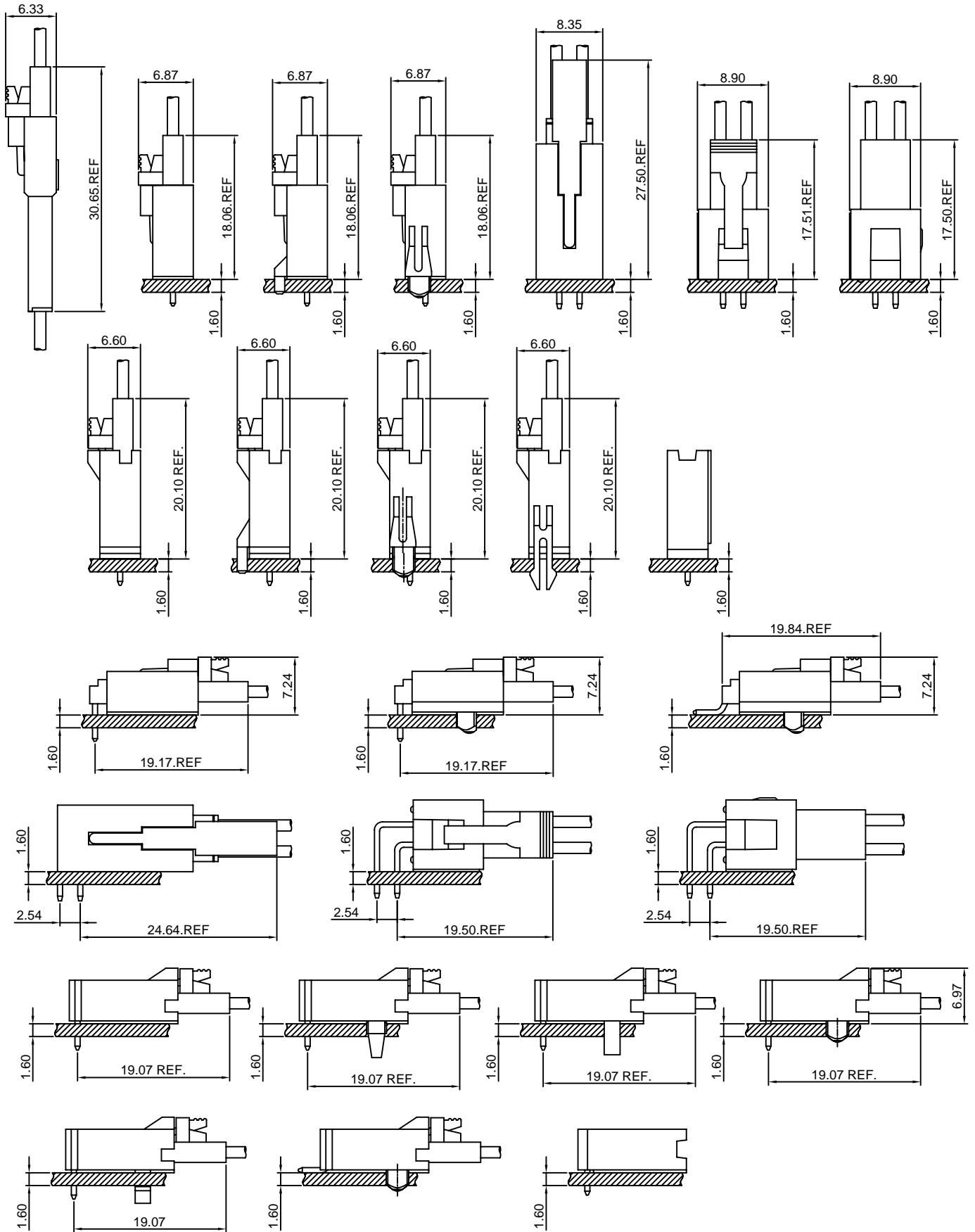

A2547-T

2.54mm Pitch Crimp Terminal

Reference Informations:

*Used in CJT A2547 series Housing

Use With CJT A2547 series Housing :

Single Row	A2547H-XP, A2547H-XP-2, A2547H-XP-3, A2547HE-XP
	A2547HG-XP, A2547HC-2P, A2547HD-2P, A2547HU-XP
Dual Row	A2547H-2xXP, A2547HA-2xXP, A2547HD-2xXP, A2547HN-2xXP
	A2547HF-2xXP, A2547HG-2xXP, A2547HJ-2xXP

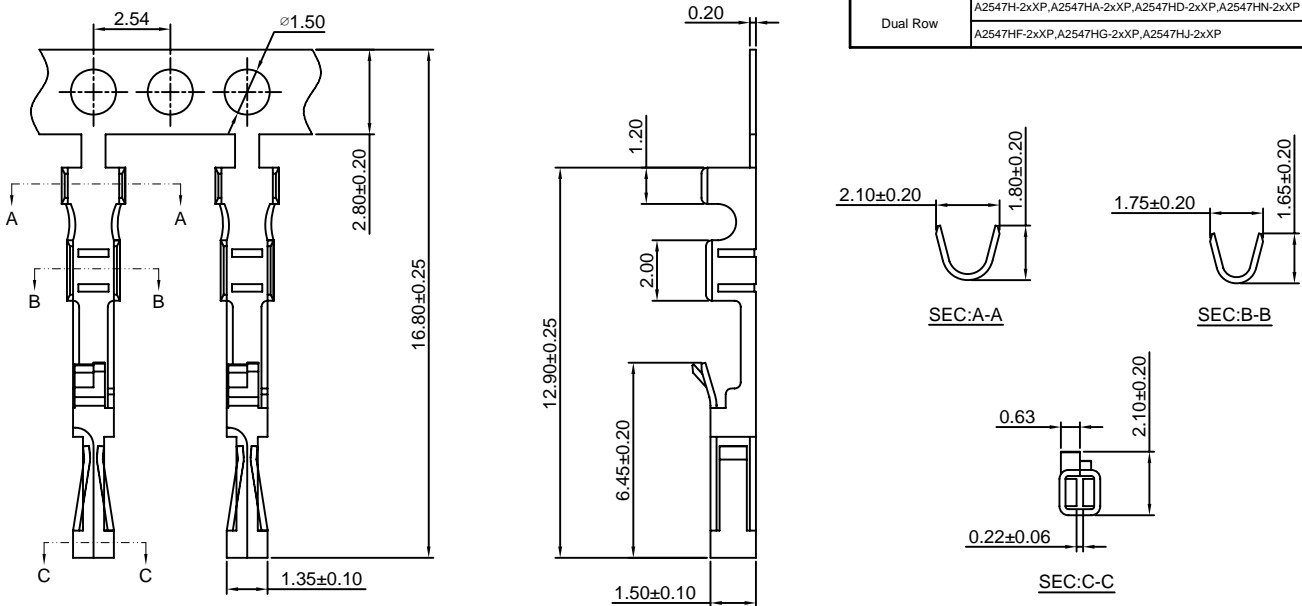

Ordering information & Specifications:

Unit:mm

Part NO.	Wire Range	Insulation O.D.	Material	Finish	Qty/reel
A2547-TP	AWG#22-#24	1.60mm(max)	Phosphor Bronze	Tin over Nickel	15,000 PCS
A2547-GP	AWG#22-#24	1.60mm(max)	Phosphor Bronze	Gold over Nickel	15,000 PCS

Optional Gold plating available but MOQ requested

A2547-T-L

2.54mm Pitch Crimp Terminal

Reference Informations:

*Used in CJT A2547 series Housing

Use With CJT A2547 series Housing :

Single Row	A2547H-XP, A2547H-XP-2, A2547H-XP-3, A2547HE-XP
	A2547HG-XP, A2547HC-2P, A2547HD-2P, A2547HU-XP
Dual Row	A2547H-2xXP, A2547HA-2xXP, A2547HD-2xXP, A2547HN-2xXP
	A2547HF-2xXP, A2547HG-2xXP, A2547HJ-2xXP

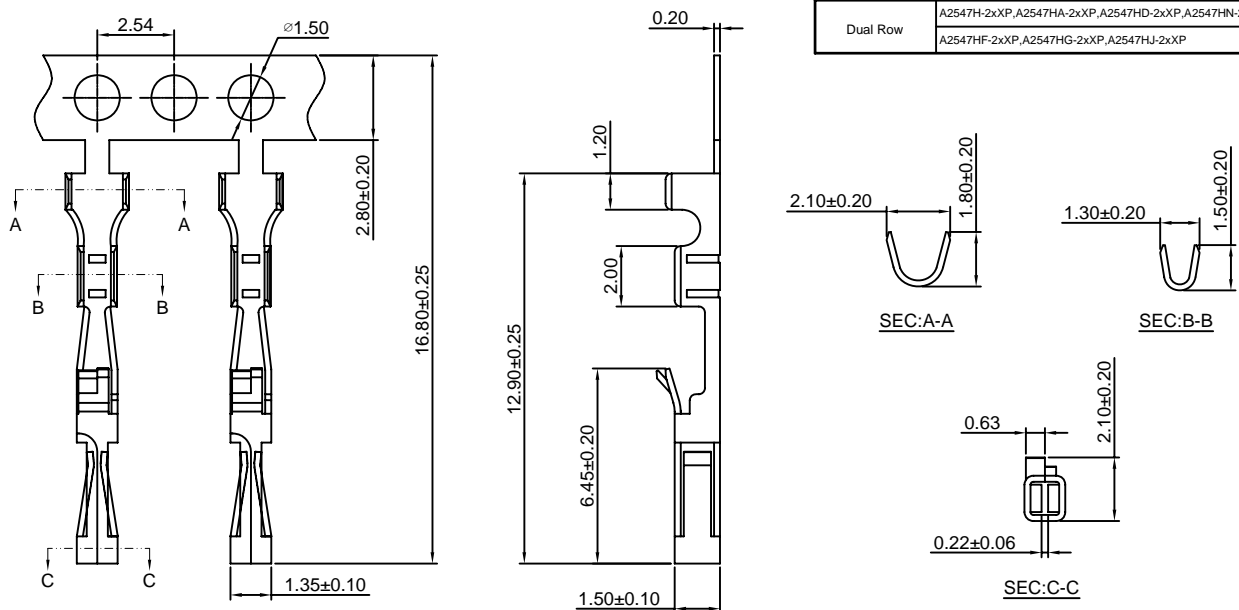

Ordering information & Specifications:

Unit:mm

Part NO.	Wire Range	Insulation O.D.	Material	Finish	Qty/reel
A2547-TP-L	AWG#24-#30	1.60mm(max)	Phosphor Bronze	Tin over Nickel	15,000 PCS
A2547-GP-L	AWG#24-#30	1.60mm(max)	Phosphor Bronze	Gold over Nickel	15,000 PCS

Optional Gold plating available but MOQ requested

A2547-T-C

2.54mm Pitch Crimp Terminal

Reference Informations:

*Used in CJT A2547 series Housing



Use With CJT A2547 series Housing :

Single Row	A2547H-XP, A2547H-XP-2, A2547H-XP-3, A2547HE-XP
	A2547HG-XP, A2547HC-2P, A2547HD-2P, A2547HU-XP
Dual Row	A2547H-2xXP, A2547HA-2xXP, A2547HD-2xXP, A2547HN-2xXP
	A2547HF-2xXP, A2547HG-2xXP, A2547HJ-2xXP



Ordering information & Specifications:

Unit:mm

Part NO.	Wire Range	Insulation O.D.	Material	Finish	Qty/reel
A2547-TP-C	AWG#22-#24	1.60mm(max)	Phosphor Bronze	Tin over Nickel	15,000 PCS
A2547-GP-C	AWG#22-#24	1.60mm(max)	Phosphor Bronze	Gold over Nickel	15,000 PCS

Optional Gold plating available but MOQ requested

A2547-T-C-L

2.54mm Pitch Crimp Terminal

Reference Informations:

*Used in CJT A2547 series Housing



Use With CJT A2547 series Housing :

Single Row	A2547H-XP, A2547H-XP-2, A2547H-XP-3, A2547HE-XP
	A2547HG-XP, A2547HC-2P, A2547HD-2P, A2547HU-XP
Dual Row	A2547H-2xXP, A2547HA-2xXP, A2547HD-2xXP, A2547HN-2xXP
	A2547HF-2xXP, A2547HG-2xXP, A2547HJ-2xXP



Ordering information & Specifications:

Unit:mm

Part NO.	Wire Range	Insulation O.D.	Material	Finish	Qty/reel
A2547-TP-C-L	AWG#24-#30	1.60mm(max)	Phosphor Bronze	Tin over Nickel	15,000 PCS
A2547-GP-C-L	AWG#24-#30	1.60mm(max)	Phosphor Bronze	Gold over Nickel	15,000 PCS

Optional Gold plating available but MOQ requested

A2547-T-B

2.54mm Pitch Crimp Terminal

Reference Informations:

*Used in CJT A2547HA, HB-XP, A2549H, HA-XP, A2549H-2xXP series Housing

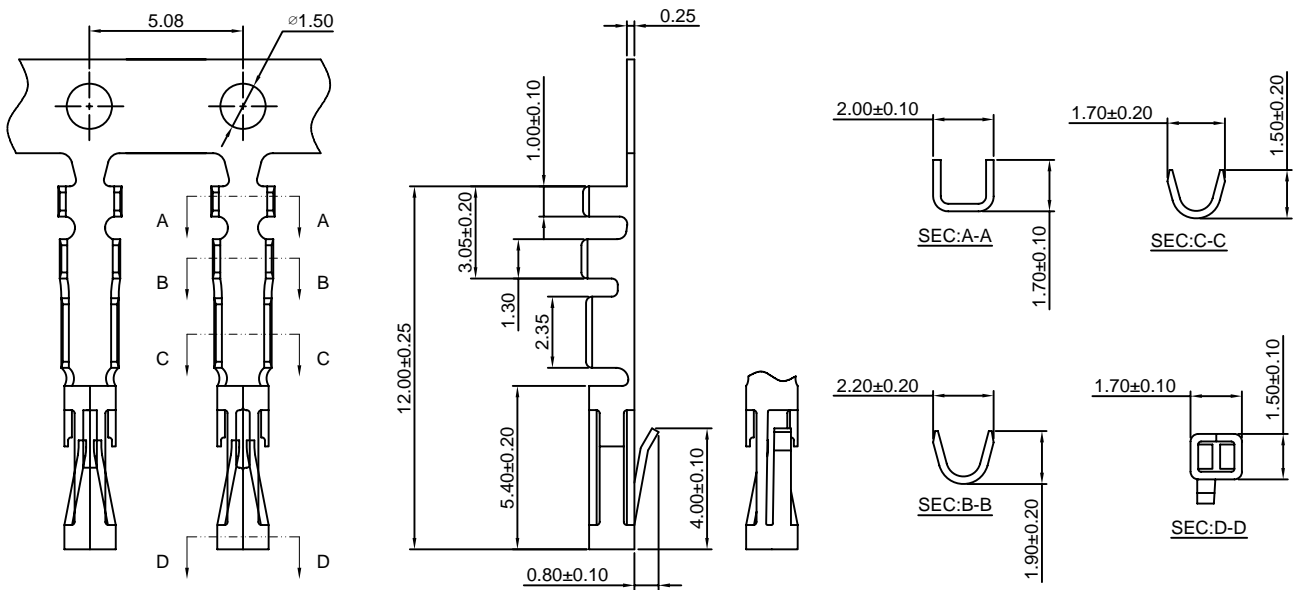

Ordering information & Specifications:

Unit:mm

Part NO.	Wire Range	Insulation O.D.	Material	Finish	Qty/reel
A2547-TP-B	AWG#22-#26	1.55mm(max)	Phosphor Bronze	Tin over Nickel	20,000 PCS
A2547-GP-B	AWG#22-#26	1.55mm(max)	Phosphor Bronze	Gold over Nickel	20,000 PCS

Optional Gold plating available but MOQ requested

A2547-T-D

2.54mm Pitch Insulation Displacement Terminal

Reference Informations:

*Used in CJT A2547 series Housing

Use With CJT A2547 series Housing :

Single Row	A2547H-XP, A2547H-XP-2, A2547H-XP-3, A2547HE-XP
	A2547HG-XP, A2547HC-2P, A2547HD-2P, A2547HJ-XP
Dual Row	A2547H-2xXP, A2547HA-2xXP, A2547HD-2xXP, A2547HN-2xXP
	A2547HF-2xXP, A2547HG-2xXP, A2547HJ-2xXP

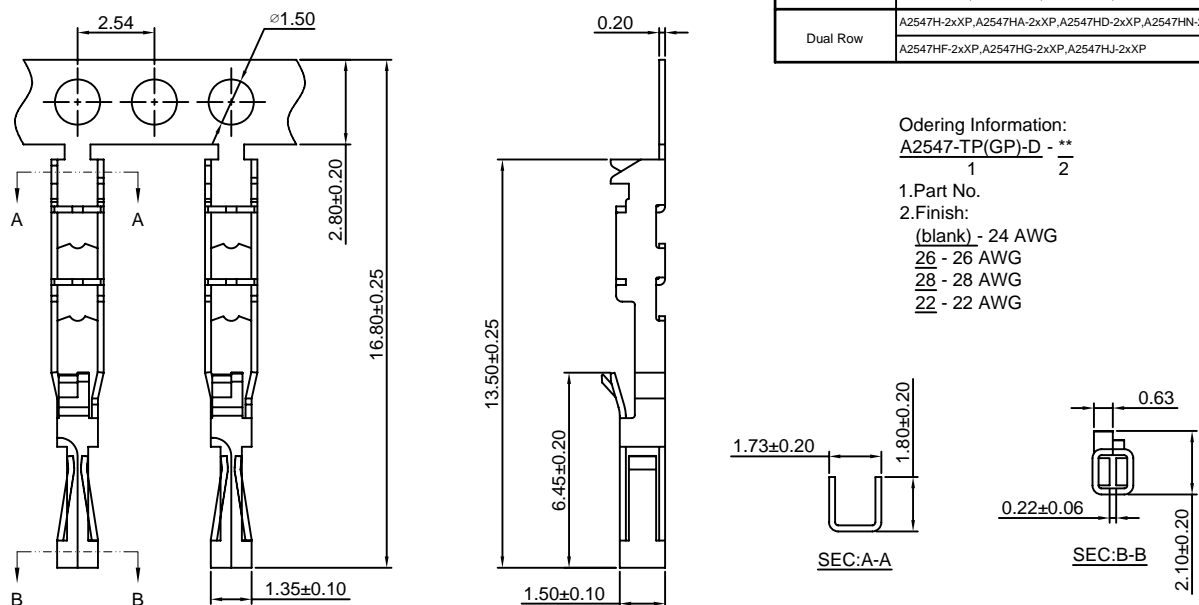

Odering Information:

A2547-TP(GP)-D - **

1. Part No.

2. Finish:

(blank) - 24 AWG

26 - 26 AWG

28 - 28 AWG

22 - 22 AWG

Ordering information & Specifications:

Unit:mm

Part NO.	Wire Range	Insulation O.D.	Material	Finish	Qty/reel
A2547-TP-D	AWG#22-#28	1.60mm(max)	Phosphor Bronze	Tin over Nickel	15,000 PCS
A2547-GP-D	AWG#22-#28	1.60mm(max)	Phosphor Bronze	Gold over Nickel	15,000 PCS

Optional Gold plating available but MOQ requested

A2547-T-S

2.54mm Pitch Crimp Terminal

Reference Informations:

*Used in CJT A2547HS, HSA-2xXP series Housing

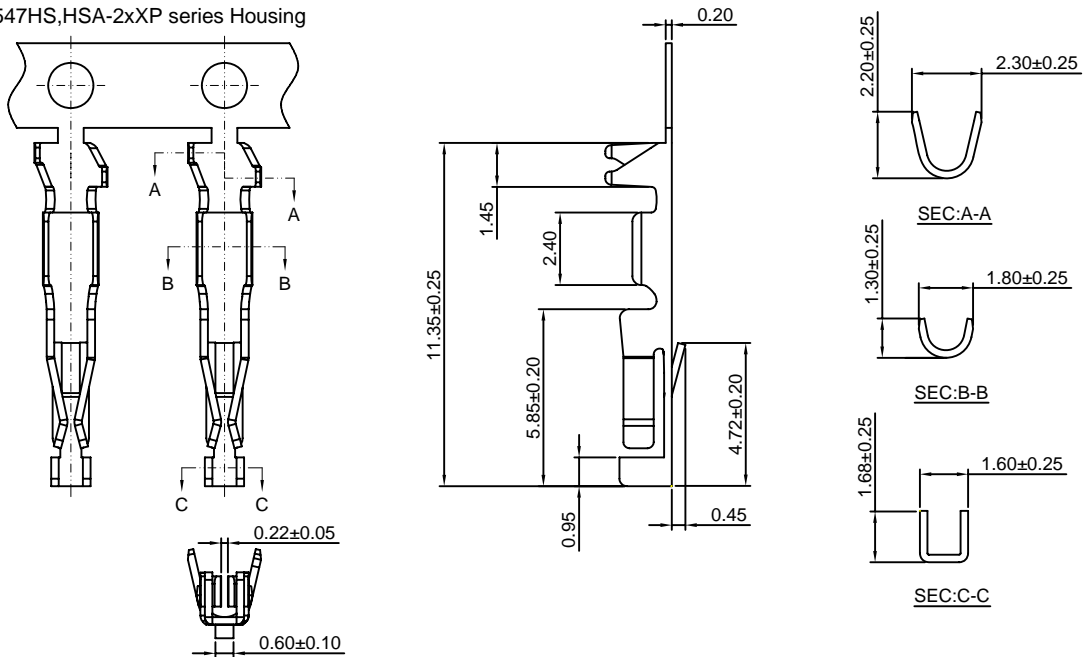

Ordering information & Specifications:

Unit:mm

Part NO.	Wire Range	Insulation O.D.	Material	Finish	Qty/reel
A2547-TP-S	AWG#22-#28	1.63mm(max)	Phosphor Bronze	Tin over Nickel	10,000 PCS
A2547-GP-S	AWG#22-#28	1.63mm(max)	Phosphor Bronze	Gold over Nickel	10,000 PCS

Optional Gold plating available but MOQ requested

A2547M-T

2.54mm Pitch Crimp Terminal

Reference Informations:

*Used in CJT A2547HM, HMA-XP, A2547H-XP-2, A2547H-XP-3, A2547HE-XP, A2547HF-2xXP series Housing

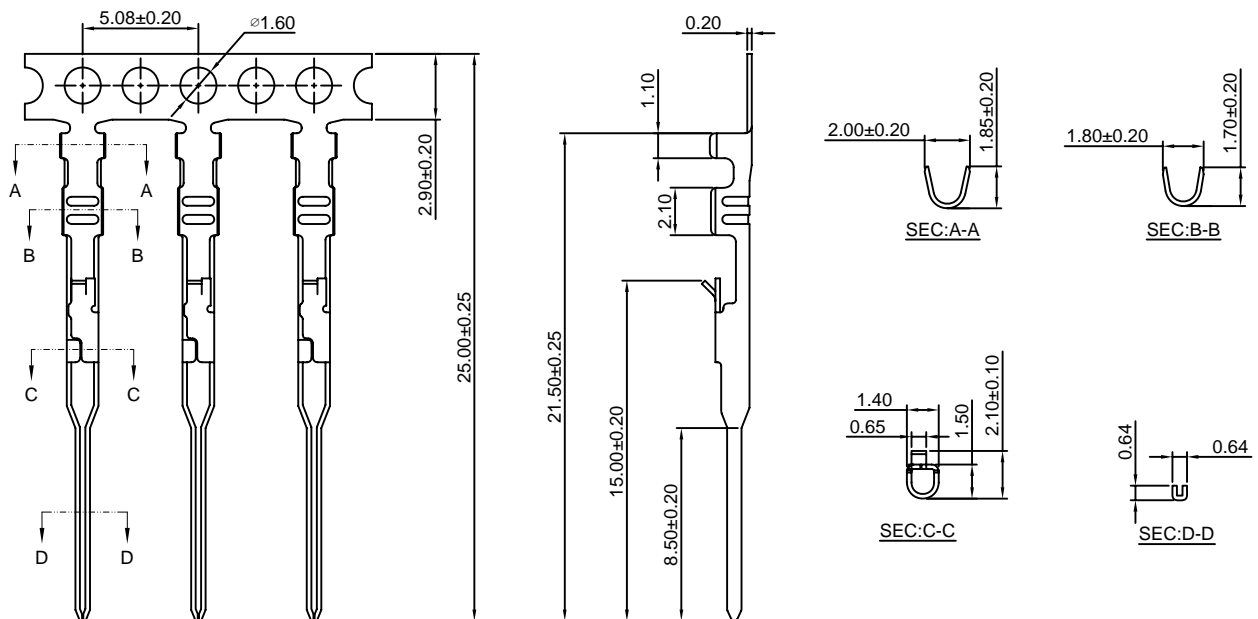

Ordering information & Specifications:

Unit:mm

Part NO.	Wire Range	Insulation O.D.	Material	Finish	Qty/reel
A2547M-TP	AWG#22-#24	1.60mm(max)	Phosphor Bronze	Tin over Nickel	15,000 PCS
A2547M-GP	AWG#22-#24	1.60mm(max)	Phosphor Bronze	Gold over Nickel	15,000 PCS

Optional Gold plating available but MOQ requested

A2547M-T-L

2.54mm Pitch Crimp Terminal

Reference Informations:

*Used in CJT A2547HM,HMA-XP,A2547H-XP-2,A2547H-XP-3,A2547HE-XP,A2547HF-2xXP series Housing

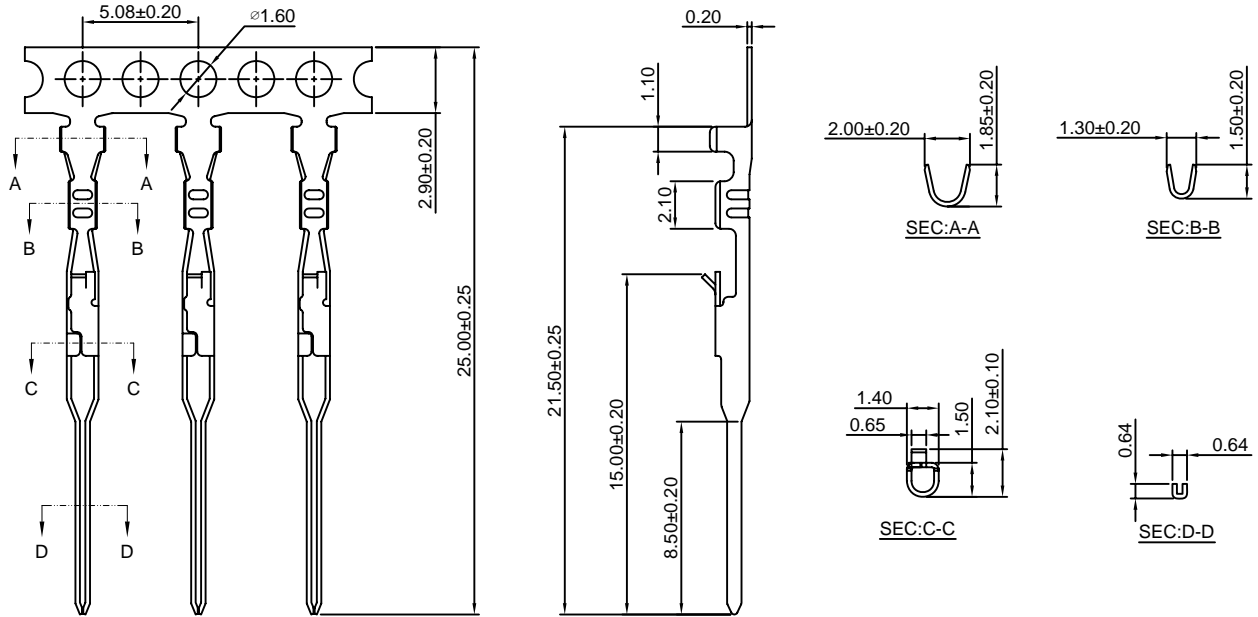

Ordering information & Specifications:

Unit:mm

Part NO.	Wire Range	Insulation O.D.	Material	Finish	Qty/reel
A2547M-TP-L	AWG#24-#30	1.60mm(max)	Phosphor Bronze	Tin over Nickel	15,000 PCS
A2547M-GP-L	AWG#24-#30	1.60mm(max)	Phosphor Bronze	Gold over Nickel	15,000 PCS

Optional Gold plating available but MOQ requested

A2547M-T-B

2.54mm Pitch Crimp Terminal

Reference Informations:

*Used in CJT A2547HMB-XP series Housing

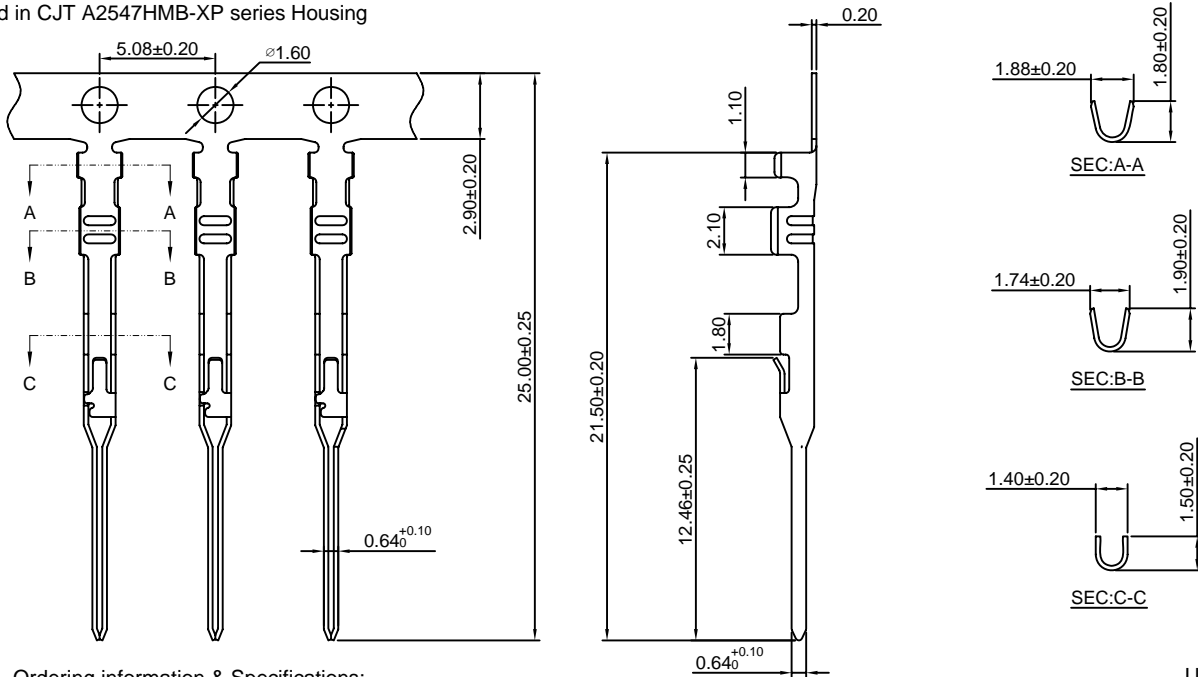

Ordering information & Specifications:

Unit:mm

Part NO.	Wire Range	Insulation O.D.	Material	Finish	Qty/reel
A2547M-TP-B	AWG#22-#26	1.63mm(max)	Phosphor Bronze	Tin over Nickel	15,000 PCS
A2547M-GP-B	AWG#22-#26	1.63mm(max)	Phosphor Bronze	Gold over Nickel	15,000 PCS

Optional Gold plating available but MOQ requested

A2547H-XP

2.54mm Pitch Housing With Lock

Reference Informations:

- *Material:PBT,UL94V-0
- *Suitable CJT A2547-T(-L) A2547-T-C(-L) A2547-T-D series Terminal
- *Mates with CJT A2547HM,HMA,HMB-XP series Housing or A2547WV,WR,WVA,WRA-XP,A2547WR-F,WR-S-F-XP series single row Wafer
- *Color:Black

Ordering Information:

- A2547H-XP - ***
 1 2
- 1.Part No.
 - 2.Material:
 (Blank):PBT,UL94V-0
 GWT:PBT,UL94V-0,GWT 750°C

Ordering Information & Dimensions:

PART NO.	Dimensions	
	A	B
2P	2.54	5.08
3P	5.08	7.62
4P	7.62	10.16
5P	10.16	12.70
6P	12.70	15.24
7P	15.24	17.78
8P	17.78	20.32
9P	20.32	22.86
10P	22.86	25.40
11P	25.40	27.94
12P	27.94	30.48
13P	30.48	33.02
14P	33.02	35.56
15P	35.56	38.10
16P	38.10	40.64
17P	40.64	43.18
18P	43.18	45.72
19P	45.72	48.26
20P	48.26	50.80
21P	50.80	53.34
22P	53.34	55.88
23P	55.88	58.42
24P	58.42	60.96
25P	60.96	63.50

Unit: mm

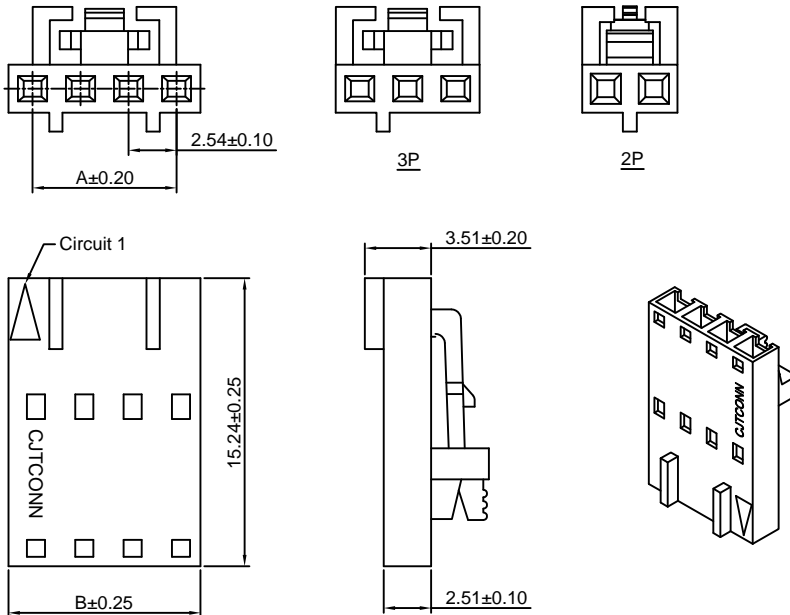

A2547H-XP-2

2.54mm Pitch Housing

Reference Informations:

- *Material:PBT,UL94V-0
- *Suitable CJT A2547-T(-L) A2547M-T(-L) A2547-T-C(-L) A2547-T-D series Terminal
- *Mates with CJT A2547 series single row Housing or A2547 A2541 series single row Wafer
- *Color:Black

Ordering Information:

- A2547H-XP-2 - ***
 1 2
- 1.Part No.
 - 2.Material:
 (Blank):PBT,UL94V-0
 GWT:PBT,UL94V-0,GWT 750°C

Ordering Information & Dimensions:

PART NO.	Dimensions	
	A	B
1P	----	2.54
2P	2.54	5.08
3P	5.08	7.62
4P	7.62	10.16
5P	10.16	12.70
6P	12.70	15.24
7P	15.24	17.78
8P	17.78	20.32
9P	20.32	22.86
10P	22.86	25.40
11P	25.40	27.94
12P	27.94	30.48
13P	30.48	33.02
14P	33.02	35.56
15P	35.56	38.10
16P	38.10	40.64
17P	40.64	43.18
18P	43.18	45.72
19P	45.72	48.26
20P	48.26	50.80
21P	50.80	53.34
22P	53.34	55.88
23P	55.88	58.42
24P	58.42	60.96
25P	60.96	63.50

Unit: mm



A2547H-XP-3

2.54mm Pitch Housing

Reference Informations:

- *Material:PBT,UL94V-0
- *Suitable CJT A2547-T(-L) A2547M-T(-L) A2547-T-C(-L) A2547-T-D series Terminal
- *Mates with CJT A2547 series single row Housing or A2547 A2541 series single row Wafer
- *Color:Black

Ordering Information:

- A2547H-XP-3 - ***
 1 2
- 1.Part No.
 - 2.Material:
 (Blank):PBT,UL94V-0
 GWT:PBT,UL94V-0,GWT 750°C

Ordering Information & Dimensions:

PART NO.	Dimensions	
	A	B
2P	2.54	5.08
3P	5.08	7.62
4P	7.62	10.16
5P	10.16	12.70
6P	12.70	15.24
7P	15.24	17.78
8P	17.78	20.32
9P	20.32	22.86
10P	22.86	25.40
11P	25.40	27.94
12P	27.94	30.48
13P	30.48	33.02
14P	33.02	35.56
15P	35.56	38.10
16P	38.10	40.64
17P	40.64	43.18
18P	43.18	45.72
19P	45.72	48.26
20P	48.26	50.80
21P	50.80	53.34
22P	53.34	55.88
23P	55.88	58.42
24P	58.42	60.96
25P	60.96	63.50

Unit: mm

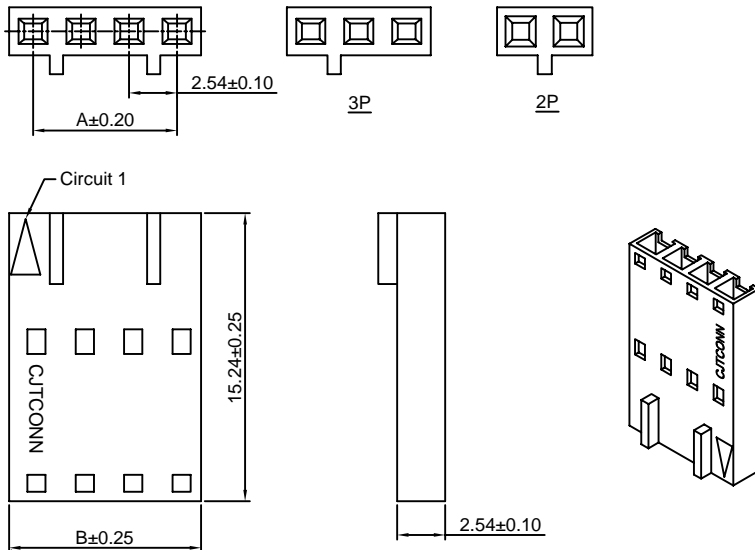

A2547HA-XP

2.54mm Pitch Housing With Lock

Reference Informations:

- *Material:PBT,UL94V-0
- *Suitable CJT A2547-T-B series Terminal
- *Mates with CJT A2547HM,HMA,HMB-XP series Housing or A2547WV,WR,WVA,WRA-XP,A2547WR-F,WR-S-F-XP series Wafer
- *Color:Black

Ordering Information:

- A2547HA-XP - ***
 1 2
- 1.Part No.
 - 2.Material:
 (Blank):PBT,UL94V-0
 GWT:PBT,UL94V-0,GWT 750°C

Ordering Information & Dimensions:

PART NO.	Dimensions	
	A	B
2P	2.54	4.92
3P	5.08	7.46
4P	7.62	10.00
5P	10.16	12.54
6P	12.70	15.08
7P	15.24	17.62
8P	17.78	20.16
9P	20.32	22.70
10P	22.86	25.24
11P	25.40	27.78
12P	27.94	30.32
13P	30.48	32.86
14P	33.02	35.40
15P	35.56	37.94
16P	38.10	40.48
17P	40.64	43.02
18P	43.18	45.56
19P	45.72	48.10
20P	48.26	50.64
21P	50.80	53.18
22P	53.34	55.72
23P	55.88	58.26
24P	58.42	60.80
25P	60.96	63.34

Unit: mm

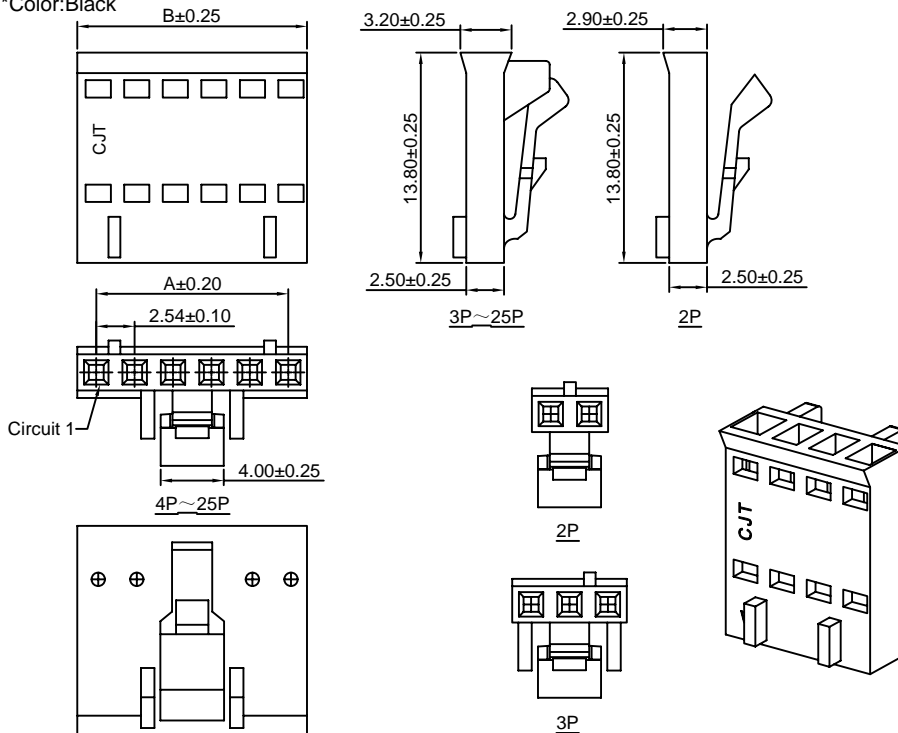

A2547HB-XP

2.54mm Pitch Housing

Reference Informations:

- *Material:PBT,UL94V-0
- *Suitable CJT A2547-T-B series Terminal
- *Mates with CJT A2547 series single row Housing or A2547 A2541 series single row Wafer
- *Color:Black

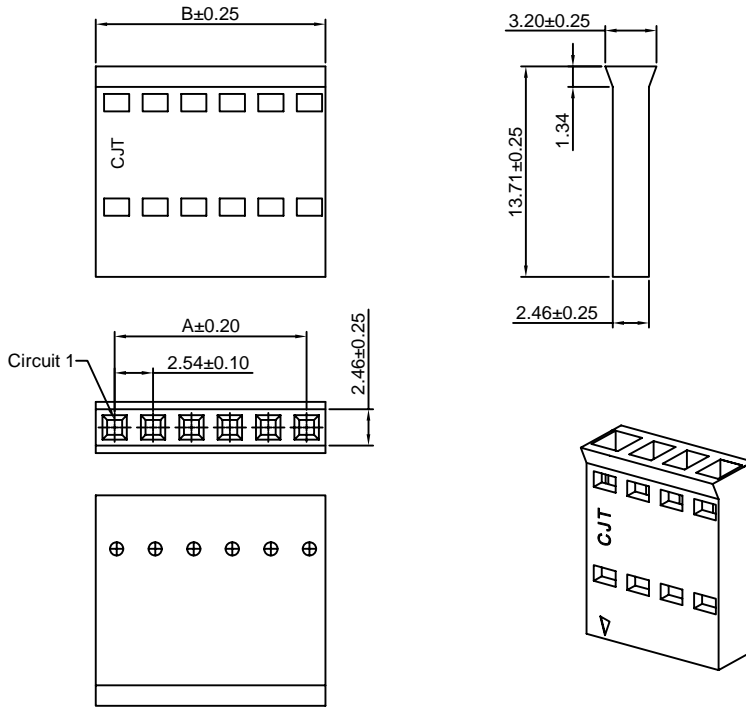

Ordering Information:

A2547HB-XP - ***
1 2

- 1.Part No.
- 2.Material:
(Blank):PBT,UL94V-0
GWT:PBT,UL94V-0,GWT 750°C

Ordering Information & Dimensions:

PART NO.	Dimensions	
	A	B
2P	2.54	4.92
3P	5.08	7.46
4P	7.62	10.00
5P	10.16	12.54
6P	12.70	15.08
7P	15.24	17.62
8P	17.78	20.16
9P	20.32	22.70
10P	22.86	25.24
11P	25.40	27.78
12P	27.94	30.32
13P	30.48	32.86
14P	33.02	35.40
15P	35.56	37.94
16P	38.10	40.48
17P	40.64	43.02
18P	43.18	45.56
19P	45.72	48.10
20P	48.26	50.64
21P	50.80	53.18
22P	53.34	55.72
23P	55.88	58.26
24P	58.42	60.80
25P	60.96	63.34

Unit: mm

A2547HE-XP

2.54mm Pitch Housing

Reference Informations:

- *Material:PBT,UL94V-0
- *Suitable CJT A2547-T(-L) A2547M-T(-L) A2547-T-C(-L) A2547-T-D series Terminal
- *Color:Black

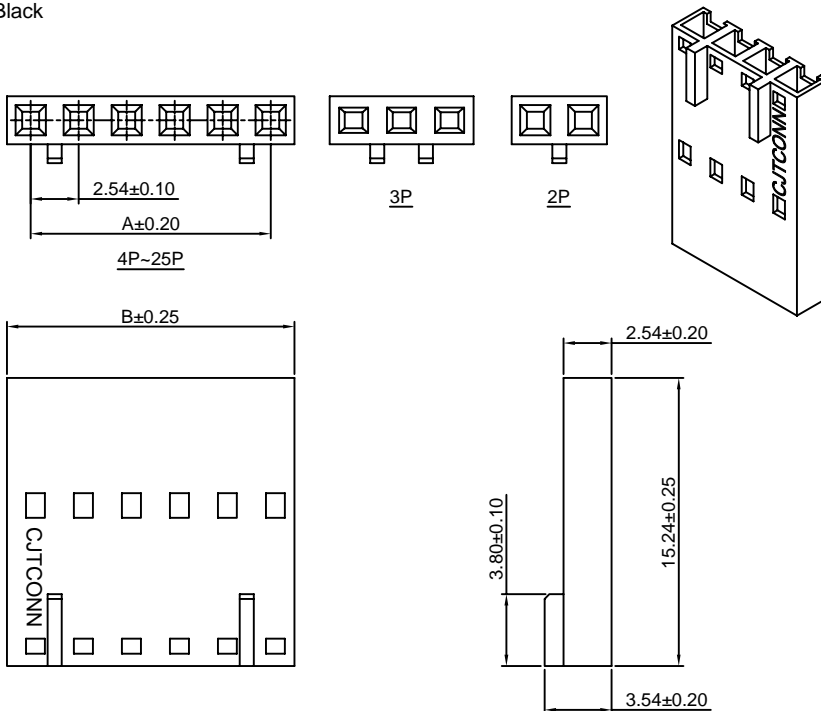

Ordering Information:

A2547HE-XP - ***
1 2

- 1.Part No.
- 2.Material:
(Blank):PBT,UL94V-0
GWT:PBT,UL94V-0,GWT 750°C

Ordering Information & Dimensions:

PART NO.	Dimensions	
	A	B
2P	2.54	5.08
3P	5.08	7.62
4P	7.62	10.16
5P	10.16	12.70
6P	12.70	15.24
7P	15.24	17.78
8P	17.78	20.32
9P	20.32	22.86
10P	22.86	25.40
11P	25.40	27.94
12P	27.94	30.48
13P	30.48	33.02
14P	33.02	35.56
15P	35.56	38.10
16P	38.10	40.64
17P	40.64	43.18
18P	43.18	45.72
19P	45.72	48.26
20P	48.26	50.80
21P	50.80	53.34
22P	53.34	55.88
23P	55.88	58.42
24P	58.42	60.96
25P	60.96	63.50

Unit: mm

A2547HG-XP

2.54mm Pitch Housing

Reference Informations:

- *Material: PBT, UL94V-0
- *Suitable CJT A2547-T(-L) A2547-T-C(-L) A2547-T-D series Terminal
- *Color: Black

Ordering Information:

- A2547HG-XP - ***
- | | |
|---|---|
| 1 | 2 |
|---|---|
1. Part No.
2. Material:
(Blank): PBT, UL94V-0
GWT: PBT, UL94V-0, GWT 750 °C

Ordering Information & Dimensions:

PART NO.	Dimensions	
	A	B
2P	2.54	5.08
3P	5.08	7.62
4P	7.62	10.16
5P	10.16	12.70
6P	12.70	15.24
7P	15.24	17.78
8P	17.78	20.32
9P	20.32	22.86
10P	22.86	25.40
11P	25.40	27.94
12P	27.94	30.48
13P	30.48	33.02
14P	33.02	35.56
15P	35.56	38.10
16P	38.10	40.64
17P	40.64	43.18
18P	43.18	45.72
19P	45.72	48.26
20P	48.26	50.80
21P	50.80	53.34
22P	53.34	55.88
23P	55.88	58.42
24P	58.42	60.96
25P	60.96	63.50

Unit: mm

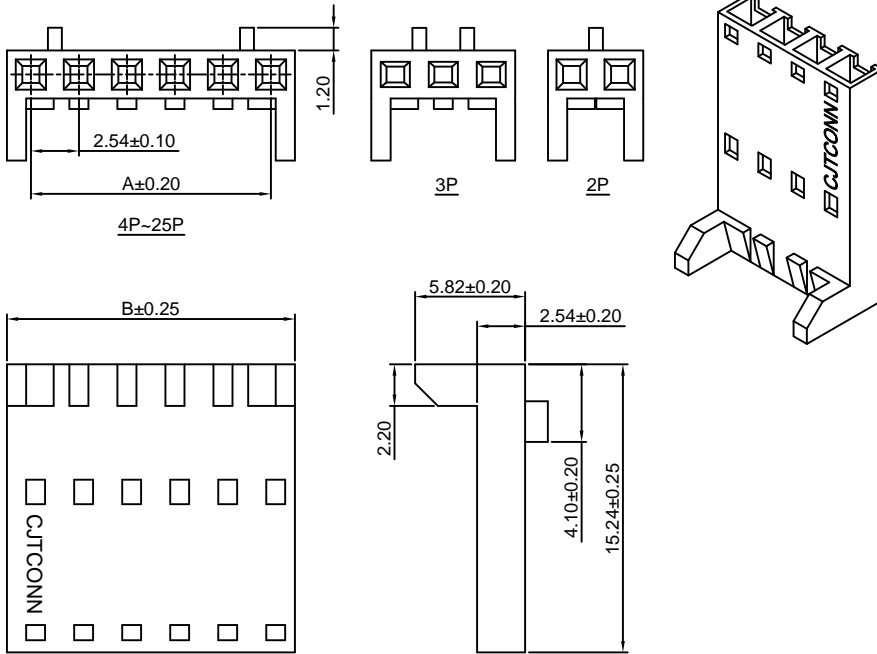

A2547HC(HD)-2P

2.54mm Pitch Housing

Reference Informations:

- *Material: Nylon 66, UL94V-0
- *Suitable CJT A2547-T(-L) A2547-T-C(-L) A2547-T-D series Terminal
- *Mates with CJT A2547HMC-2P A2547HMD-2P Housing and A2547WVC(WRC)-2P, A2547WVD(WRD)-2P Wafer

Ordering Information:

- A2547HC(HD)-2P - ***
- | | |
|---|---|
| 1 | 2 |
|---|---|
1. Part No.
2. Material:
(Blank): Nylon 66, UL94V-0
GWT: Nylon 66, UL94V-0, GWT 750 °C

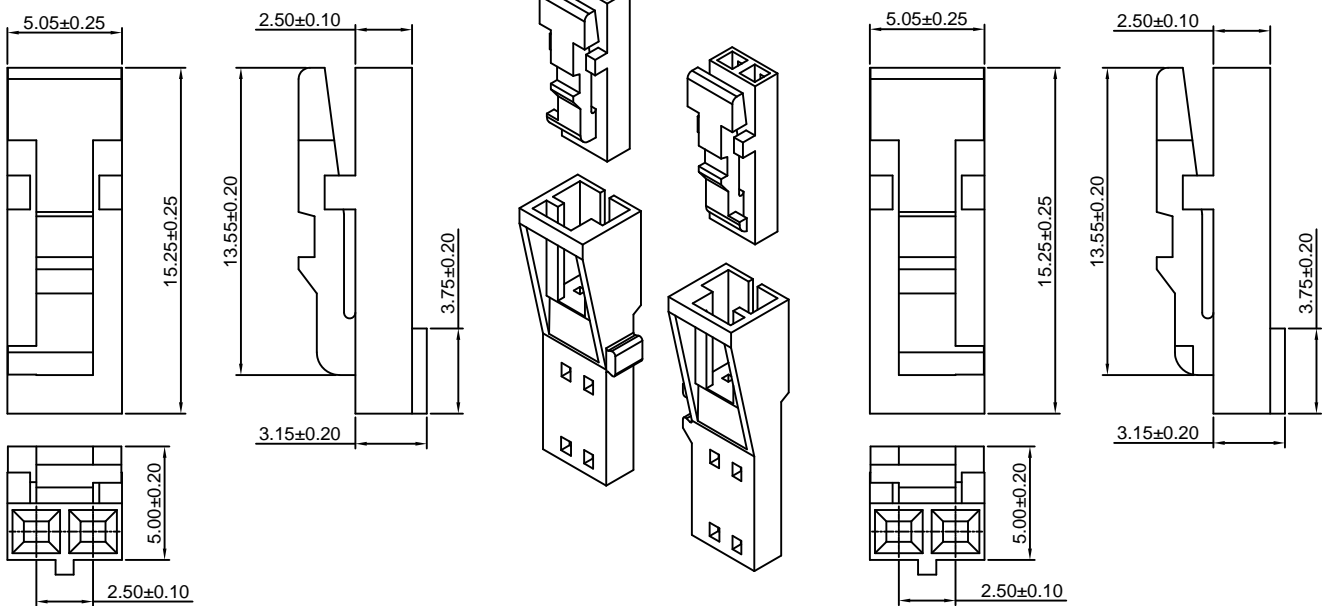

A2547HC-2P(White)
(Mates with CJT A2547HMC-2P Housing)
(Mates with CJT A2547WVC(WRC)-2P Wafer)

A2547HD-2P(Black)
(Mates with CJT A2547HMD-2P Housing)
(Mates with CJT A2547WVD(WRD)-2P Wafer)

Unit: mm

A2547WRC(WRD)-XP

2.54mm Pitch 90° Wafer

Reference Informations:

*Material: Pin: Brass/Gold over Nickel
Insulator: PBT, UL94V-0

*Mates with CJT A2547HC-2P, A2547HD-2P series Housing

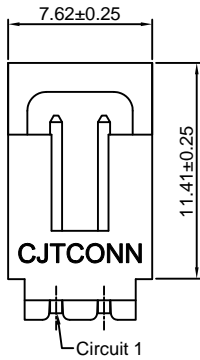
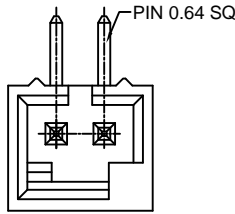

A2547WRC-2P(White)
(Mates with CJT A2547HC-2P Housing)

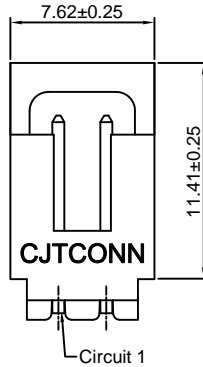
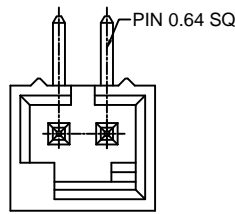

A2547WRD-2P(Black)
(Mates with CJT A2547HD-2P Housing)

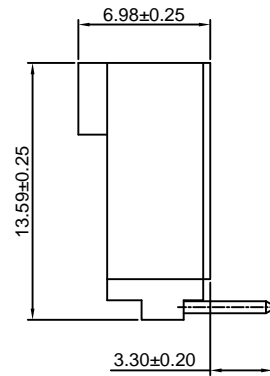

Unit: mm

A2547HM-XP

2.54mm Pitch Housing With Lock

Reference Informations:

*Material: PBT, UL94V-0

*Suitable CJT A2547M-T(-L) series Terminal

*Mates with CJT A2547H, HA-XP, A2547H-XP-3, A2550H-XP-A, A2550H-XP-A1, A2550H-XP-A2, A2550H-XP-A3H, A2550H-XP-H, A2550H-XP-M, A2550H-XP-M2 series Housing

*Color: Black

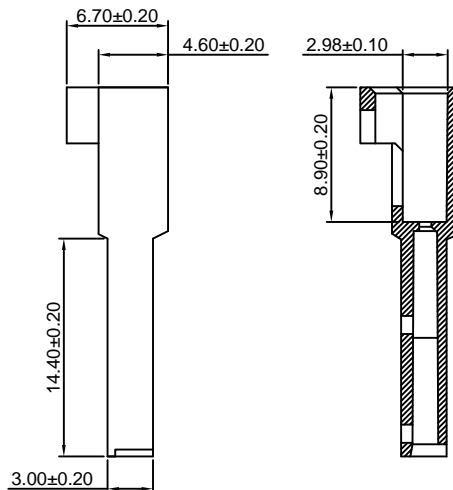
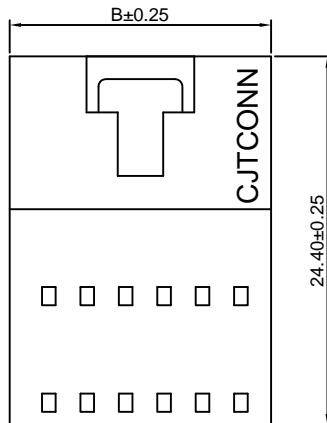
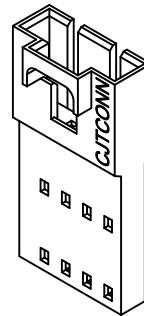
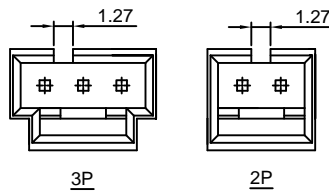
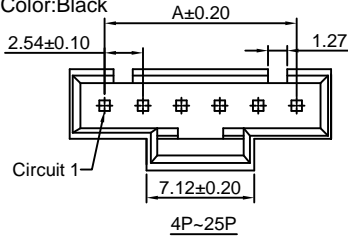

Ordering Information:

A2547HM-XP - ***
1 2

1. Part No.

2. Material:

(Blank): PBT, UL94V-0

GWT: PBT, UL94V-0, GWT 750°C

Ordering Information & Dimensions:

PART NO.	Dimensions	
	A	B
2P	2.54	7.12
3P	5.08	9.66
4P	7.62	12.20
5P	10.16	14.74
6P	12.70	17.28
7P	15.24	19.82
8P	17.78	22.36
9P	20.32	24.90
10P	22.86	27.44
11P	25.40	29.98
12P	27.94	32.52
13P	30.48	35.06
14P	33.02	37.60
15P	35.56	40.14
16P	38.10	42.68
17P	40.64	45.22
18P	43.18	47.76
19P	45.72	50.30
20P	48.26	52.84
21P	50.80	55.38
22P	53.34	57.92
23P	55.88	60.46
24P	58.42	63.00
25P	60.96	65.54

Unit: mm

A2547HMA-XP

2.54mm Pitch Housing With Lock

Reference Informations:

- *Material:PBT,UL94V-0
- *Suitable CJT A2547M-T(-L) series Terminal
- *Mates with CJT A2547H,HA-XP,A2547H-XP-3,A2550H-XP-A,A2550H-XP-A1,A2550H-XP-A2,A2550H-XP-A3H,A2550H-XP-H,A2550H-XP-M,A2550H-XP-M2 series Housing
- *Color:Black

Ordering Information:
A2547HMA-XP - ***
1 2

- Part No.
- Material:
(Blank):PBT,UL94V-0
GWT:PBT,UL94V-0,GWT 750 °C

Ordering Information & Dimensions:

PART NO.	Dimensions	
	A	B
2P	2.54	7.12
3P	5.08	9.66
4P	7.62	12.20
5P	10.16	14.74
6P	12.70	17.28
7P	15.24	19.82
8P	17.78	22.36
9P	20.32	24.90
10P	22.86	27.44
11P	25.40	29.98
12P	27.94	32.52
13P	30.48	35.06
14P	33.02	37.60
15P	35.56	40.14
16P	38.10	42.68
17P	40.64	45.22
18P	43.18	47.76
19P	45.72	50.30
20P	48.26	52.84
21P	50.80	55.38
22P	53.34	57.92
23P	55.88	60.46
24P	58.42	63.00
25P	60.96	65.54

Unit: mm



A2547HMB-XP

2.54mm Pitch Housing With Lock

Reference Informations:

- *Material:PBT,UL94V-0
- *Suitable CJT A2547M-T-B series Terminal
- *Mates with CJT A2547H,HA-XP,A2550H-XP series single row Housing
- *Color:Black

Ordering Information:
A2547HMB-XP - ***
1 2

- Part No.
- Material:
(Blank):PBT,UL94V-0
GWT:PBT,UL94V-0,GWT 750 °C

Ordering Information & Dimensions:

PART NO.	Dimensions	
	A	B
2P	2.54	7.50
3P	5.08	10.04
4P	7.62	12.58
5P	10.16	15.12
6P	12.70	17.66
7P	15.24	20.20
8P	17.78	22.74
9P	20.32	25.28
10P	22.86	27.82
11P	25.40	30.36
12P	27.94	32.90
13P	30.48	35.44
14P	33.02	37.98
15P	35.56	40.52
16P	38.10	43.06
17P	40.64	45.60
18P	43.18	48.14
19P	45.72	50.68
20P	48.26	53.22
21P	50.80	55.76
22P	53.34	58.30
23P	55.88	60.84
24P	58.42	63.38
25P	60.96	65.92

Unit: mm

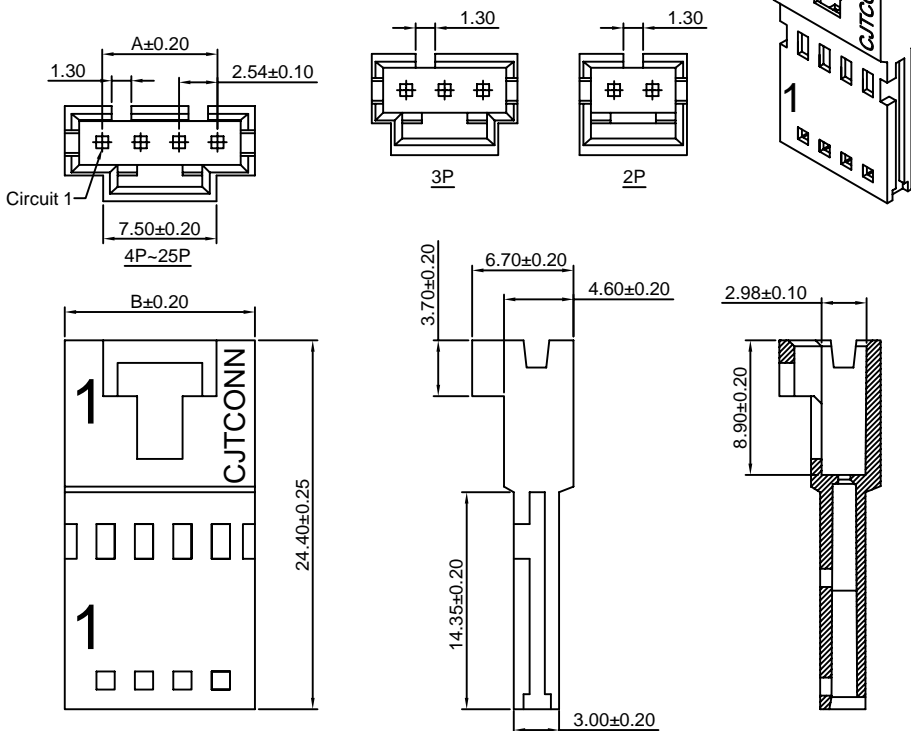

A2547HMB-4P-A

2.54mm Pitch Housing With Lock

Reference Informations:

- *Material: PBT, UL94V-0
- *Suitable CJT A2547M-T-B series Terminal
- *Mates with CJT A2550H series single row Housing
- *Color: Black

Ordering Information:
A2547HMB-4P-A - ***
1 2

1. Part No.
2. Material:
(Blank): PBT, UL94V-0
GWT: PBT, UL94V-0, GWT 750 °C



Unit: mm

A2547H-2xXP

2.54mm Pitch Dual Row Housing

Reference Informations:

- *Material: PBT, UL94V-0
- *Suitable CJT A2547-T(-L) A2547-T-C(-L) A2547-T-D series Terminal
- *Mates with CJT A2547WV, WR-2xXP, A2547HI, HIA-2xXP series Wafer
- *Color: Black

Ordering Information & Dimensions:

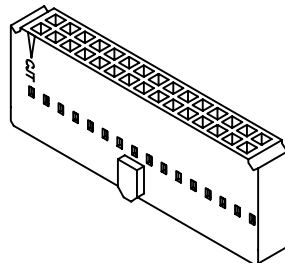

Ordering Information:
A2547H-2xXP - ***
1 2

1. Part No.
2. Material:
(Blank): PBT, UL94V-0
GWT: PBT, UL94V-0, GWT 750 °C

PART NO.	Dimensions	
	A	B
2x3P	5.08	12.22
2x4P	7.62	14.76
2x5P	10.16	17.30
2x6P	12.70	19.84
2x7P	15.24	22.38
2x8P	17.78	24.92
2x9P	20.32	27.46
2x10P	22.86	30.00
2x11P	25.40	32.54
2x12P	27.94	35.08
2x13P	30.48	37.62
2x14P	33.02	40.16
2x15P	35.56	42.70
2x16P	38.10	45.24
2x17P	40.64	47.78
2x18P	43.18	50.32
2x19P	45.72	52.86
2x20P	48.26	55.40
2x21P	50.80	57.94
2x22P	53.34	60.48
2x23P	55.88	63.02
2x24P	58.42	65.56
2x25P	60.96	68.10
2x26P	63.50	70.64
2x27P	66.04	73.18
2x28P	68.58	75.72
2x29P	71.12	78.26
2x30P	73.66	80.80
2x31P	76.20	83.34
2x32P	78.74	85.88

Unit: mm

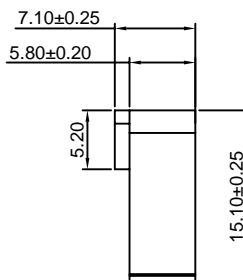
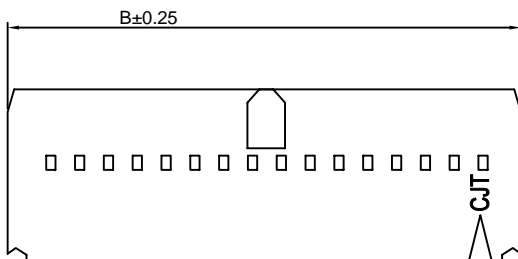

A2547HA-2xXP

2.54mm Pitch Dual Row Housing

Reference Informations:

- *Material: PBT, UL94V-0
- *Suitable CJT A2547-T(-L) A2547-T-C(-L) A2547-T-D series Terminal
- *Mates with CJT A2547WV, WR, WVC, WRC-2xXP series Wafer
- *Color: Black

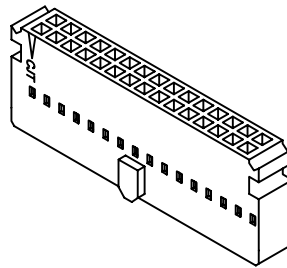
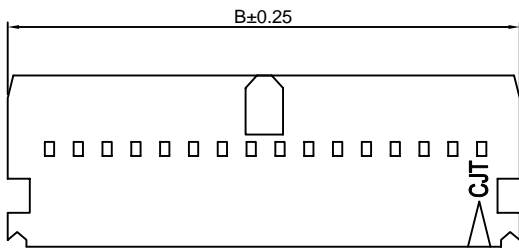
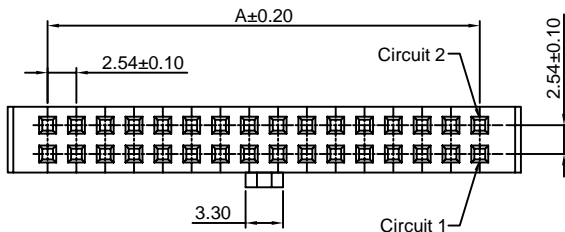

Ordering Information:

A2547HA-2xXP - ***

1. Part No.
2. Material:
(Blank): PBT, UL94V-0
GWT: PBT, UL94V-0, GWT 750°C

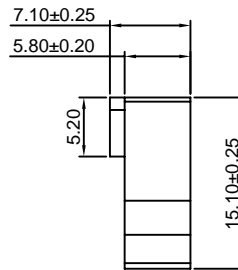

Ordering Information & Dimensions:

PART NO.	Dimensions	
	A	B
2x3P	5.08	12.22
2x4P	7.62	14.76
2x5P	10.16	17.30
2x6P	12.70	19.84
2x7P	15.24	22.38
2x8P	17.78	24.92
2x9P	20.32	27.46
2x10P	22.86	30.00
2x11P	25.40	32.54
2x12P	27.94	35.08
2x13P	30.48	37.62
2x14P	33.02	40.16
2x15P	35.56	42.70
2x16P	38.10	45.24
2x17P	40.64	47.78
2x18P	43.18	50.32
2x19P	45.72	52.86
2x20P	48.26	55.40
2x21P	50.80	57.94
2x22P	53.34	60.48
2x23P	55.88	63.02
2x24P	58.42	65.56
2x25P	60.96	68.10
2x26P	63.50	70.64
2x27P	66.04	73.18
2x28P	68.58	75.72
2x29P	71.12	78.26
2x30P	73.66	80.80
2x31P	76.20	83.34
2x32P	78.74	85.88

Unit: mm

A2547HB-2xXP

2.54mm Pitch Dual Row Housing

Reference Informations:

- *Material: PBT, UL94V-0
- *Suitable CJT A2547-T(-L) A2547-T-C(-L) A2547-T-D series Terminal
- *Mates with CJT A2547WV, WR-2xXP series Wafer
- *Color: Black

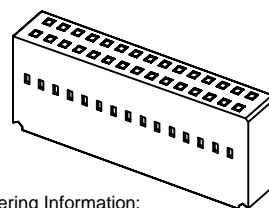
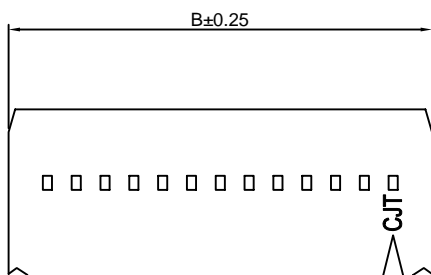
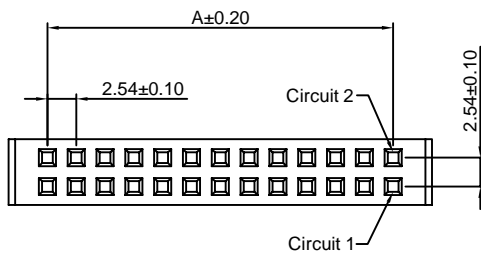

Ordering Information:

A2547HB-2xXP - ***

1. Part No.
2. Material:
(Blank): PBT, UL94V-0
GWT: PBT, UL94V-0, GWT 750°C

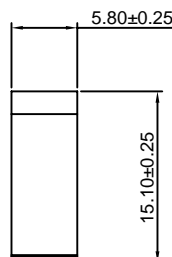

Ordering Information & Dimensions:

PART NO.	Dimensions	
	A	B
2x3P	5.08	12.22
2x4P	7.62	14.76
2x5P	10.16	17.30
2x6P	12.70	19.84
2x7P	15.24	22.38
2x8P	17.78	24.92
2x9P	20.32	27.46
2x10P	22.86	30.00
2x11P	25.40	32.54
2x12P	27.94	35.08
2x13P	30.48	37.62
2x14P	33.02	40.16
2x15P	35.56	42.70
2x16P	38.10	45.24
2x17P	40.64	47.78
2x18P	43.18	50.32
2x19P	45.72	52.86
2x20P	48.26	55.40
2x21P	50.80	57.94
2x22P	53.34	60.48
2x23P	55.88	63.02
2x24P	58.42	65.56
2x25P	60.96	68.10
2x26P	63.50	70.64
2x27P	66.04	73.18
2x28P	68.58	75.72
2x29P	71.12	78.26
2x30P	73.66	80.80
2x31P	76.20	83.34
2x32P	78.74	85.88

Unit: mm

A2547HC-2xXP

2.54mm Pitch Dual Row Housing

Reference Informations:

- *Material: PBT, UL94V-0
- *Suitable CJT A2547-T(-L) A2547-T-C(-L) A2547-T-D series Terminal
- *Mates with CJT A2547WV, WR-2xXP series Wafer
- *Color: Black



Ordering Information:

A2547HC-2xXP - ***
 $\frac{1}{2}$
 1. Part No.
 2. Material:
 (Blank): PBT, UL94V-0
 GWT: PBT, UL94V-0, GWT 750°C



Ordering Information & Dimensions:

PART NO.	Dimensions	
	A	B
2x2P	2.54	9.68
2x3P	5.08	12.22
2x4P	7.62	14.76
2x5P	10.16	17.30
2x6P	12.70	19.84
2x7P	15.24	22.38
2x8P	17.78	24.92
2x9P	20.32	27.46
2x10P	22.86	30.00
2x11P	25.40	32.54
2x12P	27.94	35.08
2x13P	30.48	37.62
2x14P	33.02	40.16
2x15P	35.56	42.70
2x16P	38.10	45.24
2x17P	40.64	47.78
2x18P	43.18	50.32
2x19P	45.72	52.86
2x20P	48.26	55.40
2x21P	50.80	57.94
2x22P	53.34	60.48
2x23P	55.88	63.02
2x24P	58.42	65.56
2x25P	60.96	68.10
2x26P	63.50	70.64
2x27P	66.04	73.18
2x28P	68.58	75.72
2x29P	71.12	78.26
2x30P	73.66	80.80
2x31P	76.20	83.34
2x32P	78.74	85.88

Unit: mm

A2547HD-2xXP

2.54mm Pitch Dual Row Housing

Reference Informations:

- *Material: PBT, UL94V-0
- *Suitable CJT A2547-T(-L) A2547-T-C(-L) A2547-T-D series Terminal
- *Mates with CJT A2547WVA, WRA-2xXP series Wafer
- *Color: Black

Ordering Information:

A2547HD-2xXP - ***
 $\frac{1}{2}$
 1. Part No.
 2. Material:
 (Blank): PBT, UL94V-0
 GWT: PBT, UL94V-0, GWT 750°C



Ordering Information & Dimensions:

PART NO.	Dimensions	
	A	B
2x25P	60.96	68.10
2x30P	73.66	80.80
2x32P	78.74	85.88

Unit: mm

A2547HN-2xXP

2.54mm Pitch Dual Row Housing

Reference Informations:

- *Material:PBT,UL94V-0
- *Suitable CJT A2549-T-C(-H/-L) series Terminal
- *Mates with CJT A2547WV-N,WR-N-2xXP, A2547WV-N-S-2xXP series Wafer
- *Color:Black

Ordering Information:

- A2547HN-2xXP - ***
- | | |
|---|---|
| 1 | 2 |
|---|---|
- 1.Part No.
 - 2.Material:
(Blank):PBT,UL94V-0
GWT:PBT,UL94V-0,GWT 750°C

Ordering Information & Dimensions:

PART NO.	Dimensions	
	A	B
2x3P	5.08	12.22
2x4P	7.62	14.76
2x5P	10.16	17.30
2x6P	12.70	19.84
2x7P	15.24	22.38
2x8P	17.78	24.92
2x9P	20.32	27.46
2x10P	22.86	30.00
2x11P	25.40	32.54
2x12P	27.94	35.08
2x13P	30.48	37.62
2x14P	33.02	40.16
2x15P	35.56	42.70
2x16P	38.10	45.24
2x17P	40.64	47.78
2x18P	43.18	50.32
2x19P	45.72	52.86
2x20P	48.26	55.40
2x21P	50.80	57.94
2x22P	53.34	60.48
2x23P	55.88	63.02
2x24P	58.42	65.56
2x25P	60.96	68.10
2x26P	63.50	70.64
2x27P	66.04	73.18
2x28P	68.58	75.72
2x29P	71.12	78.26
2x30P	73.66	80.80
2x31P	76.20	83.34
2x32P	78.74	85.88

Unit: mm

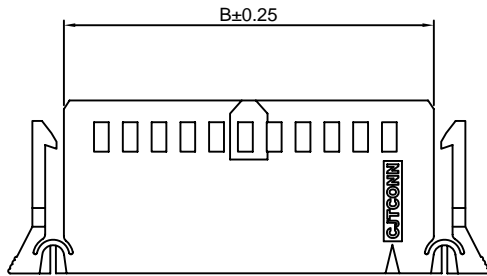

A2547HF-2xXP

2.54mm Pitch Dual Row Housing

Reference Informations:

- *Material:PBT,UL94V-0
- *Suitable CJT A2547-T(-L) A2547M-T(-L) A2547-T-C(-L) A2547-T-D series Terminal
- *Mates with CJT A2547WV,WR,WVC,WRC-2xXP series Wafer or A2541WV,WR-2xXP series Wafer
- *Color:Black

Ordering Information:

- A2547HF-2xXP - ***
- | | |
|---|---|
| 1 | 2 |
|---|---|
- 1.Part No.
 - 2.Material:
(Blank):PBT,UL94V-0
GWT:PBT,UL94V-0,GWT 750°C

Ordering Information & Dimensions:

PART NO.	Dimensions	
	A	B
2x2P	2.54	5.05
2x3P	5.08	7.59
2x4P	7.62	10.13
2x5P	10.16	12.67
2x6P	12.70	15.21
2x7P	15.24	17.75
2x8P	17.78	20.29
2x9P	20.32	22.83
2x10P	22.86	25.37
2x11P	25.40	27.91
2x12P	27.94	30.45
2x13P	30.48	32.99
2x14P	33.02	35.53
2x15P	35.56	38.07
2x16P	38.10	40.61
2x17P	40.64	43.15
2x18P	43.18	45.69
2x19P	45.72	48.23
2x20P	48.26	50.77
2x21P	50.80	53.31
2x22P	53.34	55.85
2x23P	55.88	58.39
2x24P	58.42	60.93
2x25P	60.96	63.47
2x26P	63.50	66.01
2x27P	66.04	68.55
2x28P	68.58	71.09
2x29P	71.12	73.63
2x30P	73.66	76.17
2x31P	76.20	78.71
2x32P	78.74	81.25

Unit: mm

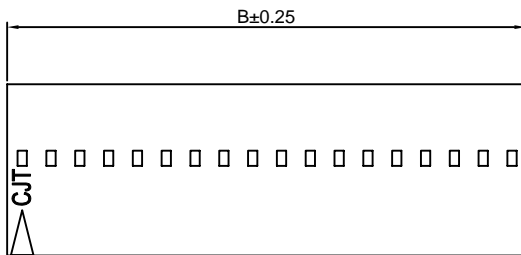
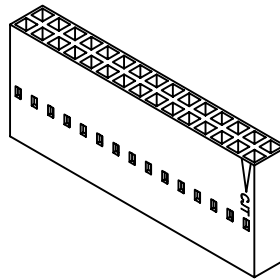
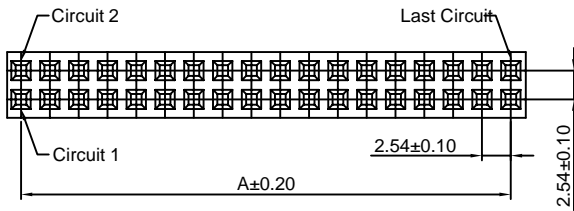

A2547HG-2xXP

2.54mm Pitch Dual Row Housing

Reference Informations:

- *Material:PBT,UL94V-0
- *Suitable CJT A2547-T(-L) A2547-T-C(-L) A2547-T-D series Terminal
- *Mates with CJT A2547WV,WR-2xXP series Wafer
- *Color:Black

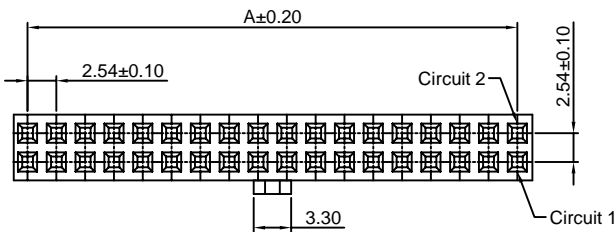

Ordering Information:
A2547HG-2xXP - ***
 1 2
 1.Part No.
 2.Material:
 (Blank):PBT,UL94V-0
 GWT :PBT,UL94V-0 GWT 750°C

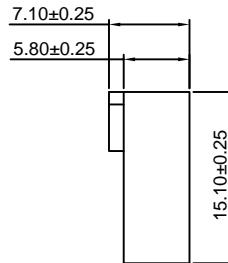
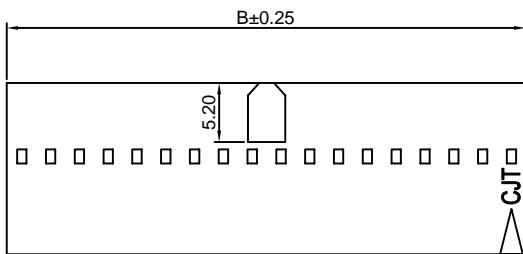

Ordering Information & Dimensions:

PART NO.	Dimensions	
	A	B
2x3P	5.08	7.59
2x4P	7.62	10.13
2x5P	10.16	12.67
2x6P	12.70	15.21
2x7P	15.24	17.75
2x8P	17.78	20.29
2x9P	20.32	22.83
2x10P	22.86	25.37
2x11P	25.40	27.91
2x12P	27.94	30.45
2x13P	30.48	32.99
2x14P	33.02	35.53
2x15P	35.56	38.07
2x16P	38.10	40.61
2x17P	40.64	43.15
2x18P	43.18	45.69
2x19P	45.72	48.23
2x20P	48.26	50.77
2x21P	50.80	53.31
2x22P	53.34	55.85
2x23P	55.88	58.39
2x24P	58.42	60.93
2x25P	60.96	63.47
2x26P	63.50	66.01
2x27P	66.04	68.55
2x28P	68.58	71.09
2x29P	71.12	73.63
2x30P	73.66	76.17
2x31P	76.20	78.71
2x32P	78.74	81.25

Unit: mm

A2547HJ-2xXP

2.54mm Pitch Dual Row Housing

Reference Informations:

- *Material:PBT,UL94V-0
- *Suitable CJT A2547-T(-L) A2547-T-C(-L) A2547-T-D series Terminal
- *Mates with CJT A2547WVB,WRB-2xXP(-A) A2547WVB-S-2xXP(-A) series Dual row Wafer
- *Color:Black

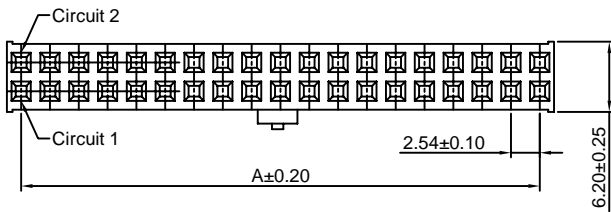
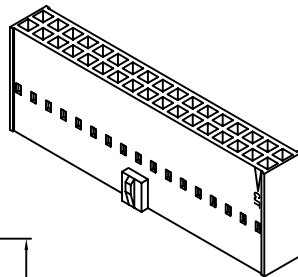

Ordering Information:
A2547HJ-2xXP - ***
 1 2
 1.Part No.
 2.Material:
 (Blank):PBT,UL94V-0
 GWT:PBT,UL94V-0 GWT 750°C

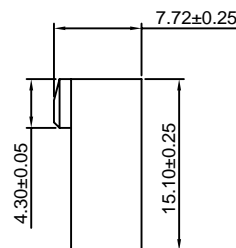
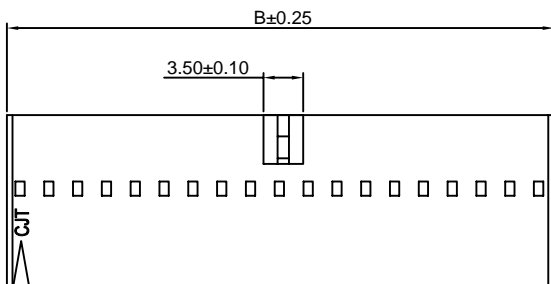

Ordering Information & Dimensions:

PART NO.	Dimensions	
	A	B
2x3P	5.08	7.59
2x4P	7.62	10.13
2x5P	10.16	12.67
2x6P	12.70	15.21
2x7P	15.24	17.75
2x8P	17.78	20.29
2x9P	20.32	22.83
2x10P	22.86	25.37
2x11P	25.40	27.91
2x12P	27.94	30.45
2x13P	30.48	32.99
2x14P	33.02	35.53
2x15P	35.56	38.07
2x16P	38.10	40.61
2x17P	40.64	43.15
2x18P	43.18	45.69
2x19P	45.72	48.23
2x20P	48.26	50.77
2x21P	50.80	53.31
2x22P	53.34	55.85
2x23P	55.88	58.39
2x24P	58.42	60.93
2x25P	60.96	63.47
2x26P	63.50	66.01
2x27P	66.04	68.55
2x28P	68.58	71.09
2x29P	71.12	73.63
2x30P	73.66	76.17
2x31P	76.20	78.71
2x32P	78.74	81.25

Unit: mm

A2547HJ-XP

2.54mm Pitch Single Row Housing

Reference Informations:

- *Material:PBT,UL94V-0
- *Suitable CJT A2547-T(-L) A2547-T-C(-L) A2547-T-D series Terminal
- *Mates with CJT A2547WVB,WRB-XP series Single Row Wafer
- *Color:Black

Ordering Information:

- A2547HJ-XP - ***
 $\frac{1}{2}$
 1.Part No.
 2.Material:
 (Blank):PBT,UL94V-0
GWT:PBT,UL94V-0,GWT 750 °C

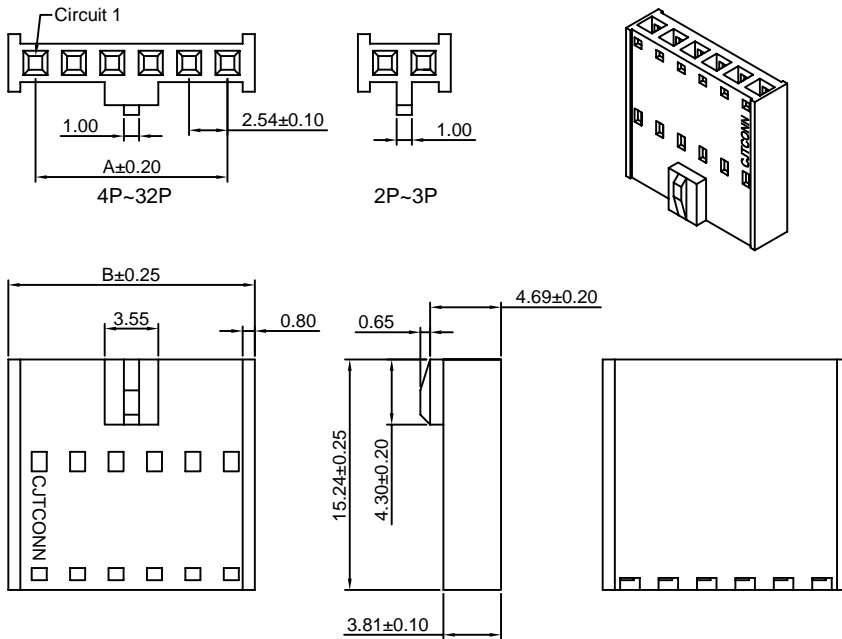

Ordering Information & Dimensions:

PART NO.	Dimensions	
	A	B
2P	2.54	6.14
3P	5.08	8.68
4P	7.62	11.22
5P	10.16	13.76
6P	12.70	16.30
7P	15.24	18.84
8P	17.78	21.38
9P	20.32	23.92
10P	22.86	26.46
11P	25.40	29.00
12P	27.94	31.54
13P	30.48	34.08
14P	33.02	36.62
15P	35.56	39.16
16P	38.10	41.70
17P	40.64	44.24
18P	43.18	46.78
19P	45.72	49.32
20P	48.26	51.86
21P	50.80	54.40
22P	53.34	56.94
23P	55.88	59.48
24P	58.42	62.02
25P	60.96	64.56
26P	63.50	67.10
27P	66.04	69.64
28P	68.58	72.18
29P	71.12	74.72
30P	73.66	77.26
31P	76.20	79.80
32P	78.74	82.34

Unit: mm

A2547HK-2xXP

2.54mm Pitch Dual Row Housing

Reference Informations:

- *Material: PBT,UL94V-0
- *Suitable CJT A2547-T(-L) A2547-T-C(-L) A2547-T-D series Terminal
- *Mates with CJT A2547WV,WR-2xXP-L series Dual row Wafer
- *Color:Black

Ordering Information:

- A2547HK-2xXP - ***
 $\frac{1}{2}$
 1.Part No.
 2.Material:
 (Blank):PBT,UL94V-0
GWT:PBT,UL94V-0,GWT 750 °C

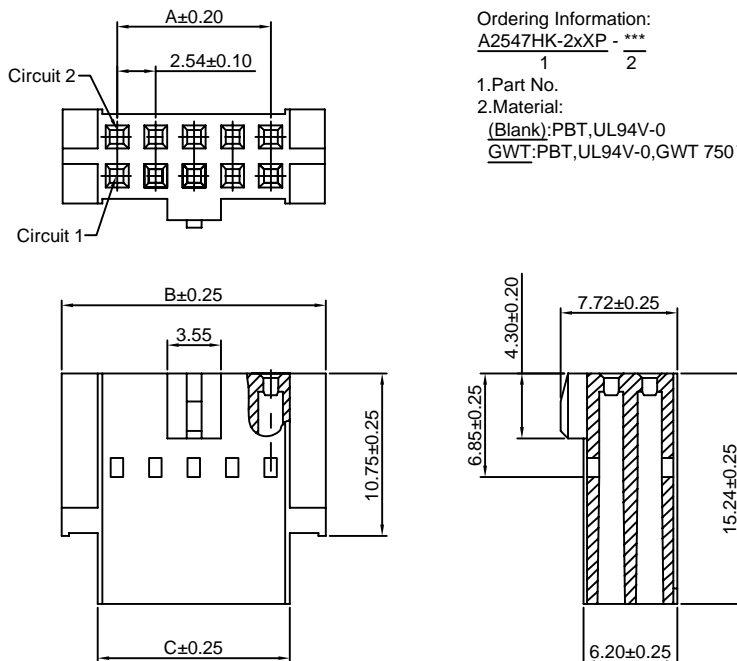

Ordering Information & Dimensions:

PART NO.	Dimensions		
	A	B	C
2x4P	7.62	14.93	10.16
2x5P	10.16	17.47	12.70
2x6P	12.70	20.01	15.24
2x7P	15.24	22.55	17.78
2x8P	17.78	25.09	20.32
2x9P	20.32	27.63	22.86
2x10P	22.86	30.17	25.40
2x11P	25.40	32.71	27.94
2x12P	27.94	35.25	30.48
2x13P	30.48	37.79	33.02
2x14P	33.02	40.33	35.56
2x15P	35.56	42.87	38.10
2x16P	38.10	45.41	40.64
2x17P	40.64	47.95	43.18
2x18P	43.18	50.49	45.72
2x19P	45.72	53.03	48.26
2x20P	48.26	55.57	50.80
2x21P	50.80	58.11	53.34
2x22P	53.34	60.65	55.88
2x23P	55.88	63.19	58.42
2x24P	58.42	65.73	60.96
2x25P	60.96	68.27	63.50
2x26P	63.50	70.81	66.04
2x27P	66.04	73.35	68.58
2x28P	68.58	75.89	71.12
2x29P	71.12	78.43	73.66
2x30P	73.66	80.97	76.20
2x31P	76.20	83.51	78.74
2x32P	78.74	86.05	81.28

Unit: mm

A2547HL-2xXP

2.54mm Pitch Dual Row Housing

Reference Informations:

- *Material: PBT,UL94V-0
- *Suitable CJT A2547 series Terminal
- *Mates with CJT A2547 series Wafer
- *Color:Black

Ordering Information:

- A2547HL-2xXP - ***
 1 2
 1.Part No.
 2.Material:
 (Blank):PBT,UL94V-0
 GWT:PBT,UL94V-0 GWT 750 °C

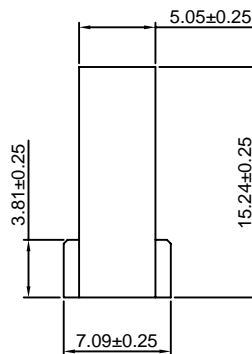
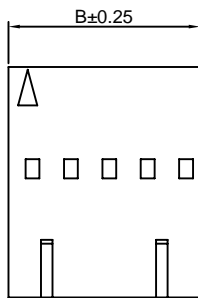
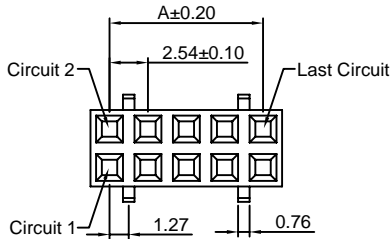

Ordering Information & Dimensions:

PART NO.	Dimensions	
	A	B
2x2P	2.54	5.05
2x3P	5.08	7.59
2x4P	7.62	10.13
2x5P	10.16	12.67
2x6P	12.70	15.21
2x7P	15.24	17.75
2x8P	17.78	20.29
2x9P	20.32	22.83
2x10P	22.86	25.37
2x11P	25.40	27.91
2x12P	27.94	30.45
2x13P	30.48	32.99
2x14P	33.02	35.53
2x15P	35.56	38.07
2x16P	38.10	40.61
2x17P	40.64	43.15
2x18P	43.18	45.69
2x19P	45.72	48.23
2x20P	48.26	50.77
2x21P	50.80	53.31
2x22P	53.34	55.85
2x23P	55.88	58.39
2x24P	58.42	60.93
2x25P	60.96	63.47
2x26P	63.50	66.01
2x27P	66.04	68.55
2x28P	68.58	71.09
2x29P	71.12	73.63
2x30P	73.66	76.17
2x31P	76.20	78.71
2x32P	78.74	81.25

Unit: mm

A2547HP-2xXP

2.54mm Pitch Dual Row Housing

Reference Informations:

- *Material: PBT,UL94V-0
- *Suitable CJT A2547 series Terminal
- *Mates with CJT A2547 series Wafer
- *Color:Black

Ordering Information:

- A2547HP-2xXP - ***
 1 2
 1.Part No.
 2.Material:
 (Blank):PBT,UL94V-0
 GWT:PBT,UL94V-0 GWT 750 °C

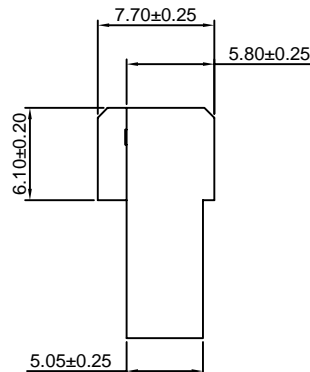
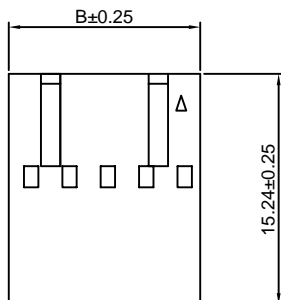
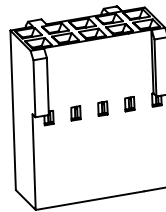
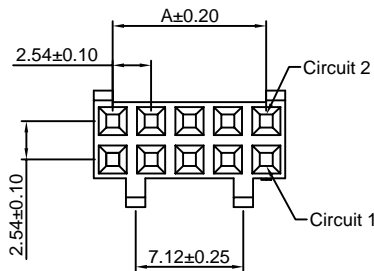

Ordering Information & Dimensions:

PART NO.	Dimensions	
	A	B
2x2P	2.54	5.05
2x3P	5.08	7.59
2x4P	7.62	10.13
2x5P	10.16	12.67
2x6P	12.70	15.21
2x7P	15.24	17.75
2x8P	17.78	20.29
2x9P	20.32	22.83
2x10P	22.86	25.37
2x11P	25.40	27.91
2x12P	27.94	30.45
2x13P	30.48	32.99
2x14P	33.02	35.53
2x15P	35.56	38.07
2x16P	38.10	40.61
2x17P	40.64	43.15
2x18P	43.18	45.69
2x19P	45.72	48.23
2x20P	48.26	50.77
2x21P	50.80	53.31
2x22P	53.34	55.85
2x23P	55.88	58.39
2x24P	58.42	60.93
2x25P	60.96	63.47
2x26P	63.50	66.01
2x27P	66.04	68.55
2x28P	68.58	71.09
2x29P	71.12	73.63
2x30P	73.66	76.17
2x31P	76.20	78.71
2x32P	78.74	81.25

Unit: mm

A2547WV-XP

2.54mm Pitch 180° Wafer

Reference Informations:

- *Material: Pin: Brass/Gold over Nickel
Insulator: PBT, UL94V-0
- *Mates with CJT A2547H-XP(-2,-3), A2547HA, HB-XP, A2550H-XP-(A,A1,A2,A3H,B,H,G,M,M1,M2), A2541H-XP series Housing
- *Color: Black

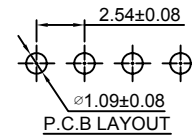
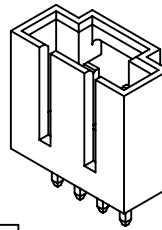

Ordering Information & Dimensions:

PART NO.	Dimensions	
	A	B
2P	2.54	7.62
3P	5.08	10.16
4P	7.62	12.70
5P	10.16	15.24
6P	12.70	17.78
7P	15.24	20.32
8P	17.78	22.86
9P	20.32	25.40
10P	22.86	27.94
11P	25.40	30.48
12P	27.94	33.02
13P	30.48	35.56
14P	33.02	38.10
15P	35.56	40.64
16P	38.10	43.18
17P	40.64	45.72
18P	43.18	48.26
19P	45.72	50.80
20P	48.26	53.34
21P	50.80	55.88
22P	53.34	58.42
23P	55.88	60.96
24P	58.42	63.50
25P	60.96	66.04

Unit: mm

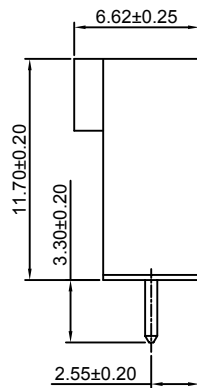
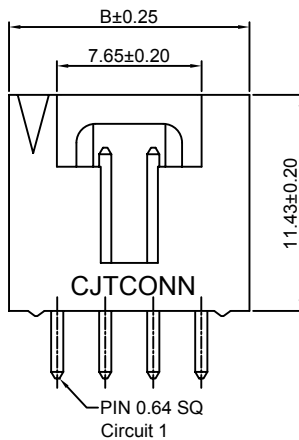
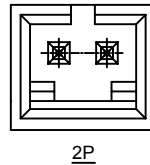
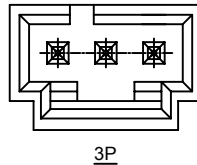
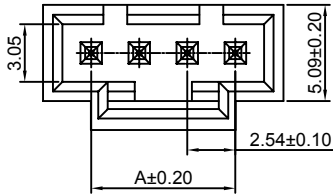

Ordering Information:
A2547WV-XP - *** - ***
1 2 3

- Part No.
- Material:
(Blank): PBT, UL94V-0
6T: Nylon 6T, UL94V-0
GWT: PBT, UL94V-0, GWT 750°C
- Finish:
(blank): Gold-flash
G15: 15µin (0.38µm) MIN. Select Gold (Mating Area)
100µin (2.54µm) MIN. Select Tin
G30: 30µin (0.76µm) MIN. Select Gold (Mating Area)
100µin (2.54µm) MIN. Select Tin
T: Tin over Nickel

A2547WR-XP

2.54mm Pitch 90° Wafer

Reference Informations:

- *Material: Pin: Brass/Gold over Nickel
Insulator: PBT, UL94V-0
- *Mates with CJT A2547H-XP(-2,-3), A2547HA, HB-XP, A2550H-XP-(A,A1,A2,A3H,B,H,G,M,M1,M2), A2541H-XP series Housing
- *Color: Black

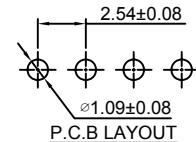
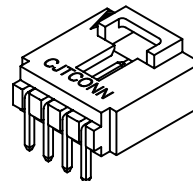

Ordering Information & Dimensions:

PART NO.	Dimensions	
	A	B
2P	2.54	7.62
3P	5.08	10.16
4P	7.62	12.70
5P	10.16	15.24
6P	12.70	17.78
7P	15.24	20.32
8P	17.78	22.86
9P	20.32	25.40
10P	22.86	27.94
11P	25.40	30.48
12P	27.94	33.02
13P	30.48	35.56
14P	33.02	38.10
15P	35.56	40.64
16P	38.10	43.18
17P	40.64	45.72
18P	43.18	48.26
19P	45.72	50.80
20P	48.26	53.34
21P	50.80	55.88
22P	53.34	58.42
23P	55.88	60.96
24P	58.42	63.50
25P	60.96	66.04

Unit: mm

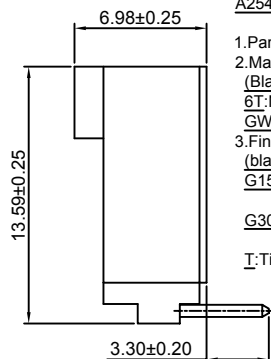
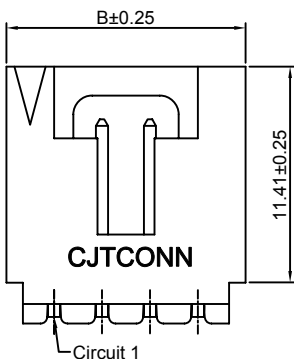
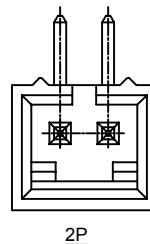
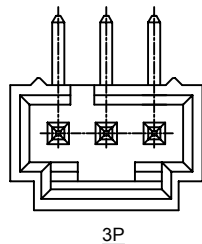
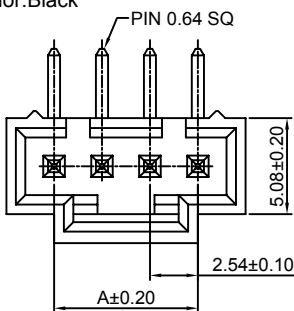

Ordering Information:
A2547WR-XP - *** - ***
1 2 3

- Part No.
- Material:
(Blank): PBT, UL94V-0
6T: Nylon 6T, UL94V-0
GWT: PBT, UL94V-0, GWT 750°C
- Finish:
(blank): Gold-flash
G15: 15µin (0.38µm) MIN. Select Gold (Mating Area)
100µin (2.54µm) MIN. Select Tin
G30: 30µin (0.76µm) MIN. Select Gold (Mating Area)
100µin (2.54µm) MIN. Select Tin
T: Tin over Nickel

A2547WR-XP-2

2.54mm Pitch 90° Wafer

Reference Informations:

- *Material: Pin: Brass/Gold over Nickel
Insulator: PBT, UL94V-0
- *Mates with CJT A2547H-XP(-2,-3), A2547HA, HB-XP, A2550H-XP-(A,A1,A2,A3H,B,H,G,M,M1,M2), A2541H-XP series Housing
- *Color: Black

Ordering Information:

A2547WR-XP-2 - *** - ***
1 2 3

- Part No.
- Material:
(Blank): PBT, UL94V-0
6T: Nylon 6T, UL94V-0
GWT: PBT, UL94V-0, GWT 750°C
- Finish:
(blank): Gold-flash
G15: 15µm (0.38µm) MIN. Select Gold (Mating Area)
100µm (2.54µm) MIN. Select Tin
G30: 30µm (0.76µm) MIN. Select Gold (Mating Area)
100µm (2.54µm) MIN. Select Tin
T: Tin over Nickel

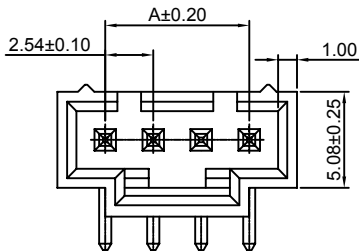

4P-25P

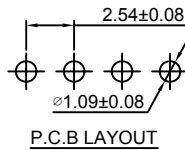

P.C.B LAYOUT

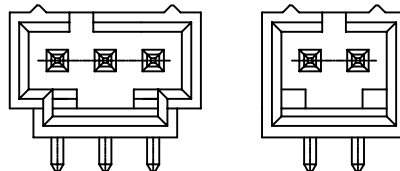

3P

2P

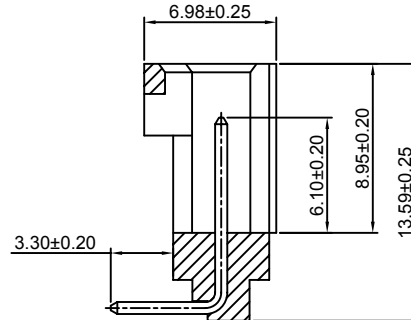
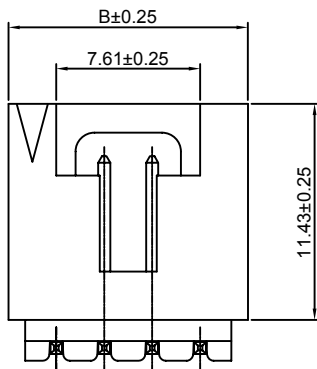

Ordering Information & Dimensions:

PART NO.	Dimensions	
	A	B
2P	2.54	7.62
3P	5.08	10.16
4P	7.62	12.70
5P	10.16	15.24
6P	12.70	17.78
7P	15.24	20.32
8P	17.78	22.86
9P	20.32	25.40
10P	22.86	27.94
11P	25.40	30.48
12P	27.94	33.02
13P	30.48	35.56
14P	33.02	38.10
15P	35.56	40.64

Unit: mm

A2547WV-S-XP

2.54mm Pitch 180° Wafer - SMT TYPE

Reference Informations:

- *Material: Pin: Brass/Gold over Nickel
Insulator: LCP, UL94V-0
- *Mates with CJT A2547H-XP(-2,-3), A2547HA, HB-XP, A2550H-XP-(A,A1,A2,A3H,B,H,G,M,M1,M2), A2541H-XP series Housing
- *Color: Black

Ordering Information:

A2547WV-S-XP - *** - ***
1 2 3

- Part No.
- Material:
(Blank): LCP, UL94V-0
6T: Nylon 6T, UL94V-0
GWT: LCP, UL94V-0, GWT 750°C
- Finish:
(blank): Gold-flash
G15: 15µm (0.38µm) MIN. Select Gold (Mating Area)
100µm (2.54µm) MIN. Select Tin
G30: 30µm (0.76µm) MIN. Select Gold (Mating Area)
100µm (2.54µm) MIN. Select Tin
T: Tin over Nickel

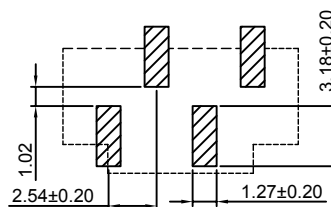

P.C.B LAYOUT

Ordering Information & Dimensions:

PART NO.	Dimensions	
	A	B
3P	5.08	10.16
4P	7.62	12.70
5P	10.16	15.24
6P	12.70	17.78
7P	15.24	20.32
8P	17.78	22.86
9P	20.32	25.40
10P	22.86	27.94
11P	25.40	30.48
12P	27.94	33.02
13P	30.48	35.56
14P	33.02	38.10
15P	35.56	40.64
16P	38.10	43.18
17P	40.64	45.72
18P	43.18	48.26
19P	45.72	50.80
20P	48.26	53.34
21P	50.80	55.88
22P	53.34	58.42
23P	55.88	60.96
24P	58.42	63.50
25P	60.96	66.04

Unit: mm

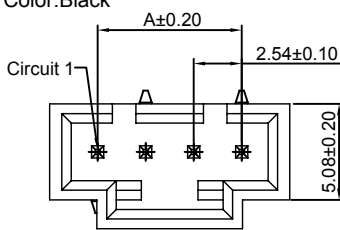

4P~25P

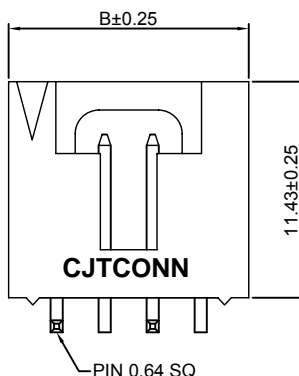

CJTCONN

PIN 0.64 SQ

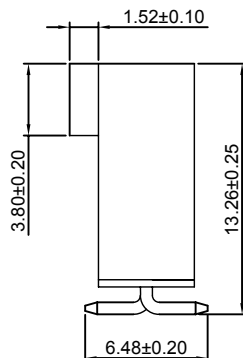

3P

A2547WR-F-XP

2.54mm Pitch 90° Wafer With Peg

Reference Informations:

- *Material: Pin: Brass/Gold over Nickel
Insulator: PBT, UL94V-0
- *Mates with CJT A2547H-XP(-2,-3), A2547HA, HB-XP, A2550H-XP-(A,A1,A2,A3H,B,H,G,M,M1,M2), A2541H-XP series Housing
- *Color: Black

Ordering Information:

A2547WR-F-XP - *** - ***
1 2 3

- Part No.
- Material:
(Blank): PBT, UL94V-0
6T: Nylon 6T, UL94V-0
GWT: PBT, UL94V-0, GWT 750°C
- Finish:
(blank): Gold-flash
G15: 15µin (0.38µm) MIN. Select Gold (Mating Area)
100µin (2.54µm) MIN. Select Tin
G30: 30µin (0.76µm) MIN. Select Gold (Mating Area)
100µin (2.54µm) MIN. Select Tin
T: Tin over Nickel

Ordering Information & Dimensions:

PART NO.	Dimensions	
	A	B
2P	2.54	7.62
3P	5.08	10.16
4P	7.62	12.70
5P	10.16	15.24
6P	12.70	17.78
7P	15.24	20.32
8P	17.78	22.86
9P	20.32	25.40
10P	22.86	27.94
11P	25.40	30.48
12P	27.94	33.02
13P	30.48	35.56
14P	33.02	38.10
15P	35.56	40.64
16P	38.10	43.18
17P	40.64	45.72
18P	43.18	48.26
19P	45.72	50.80
20P	48.26	53.34
21P	50.80	55.88
22P	53.34	58.42
23P	55.88	60.96
24P	58.42	63.50
25P	60.96	66.04

Unit: mm

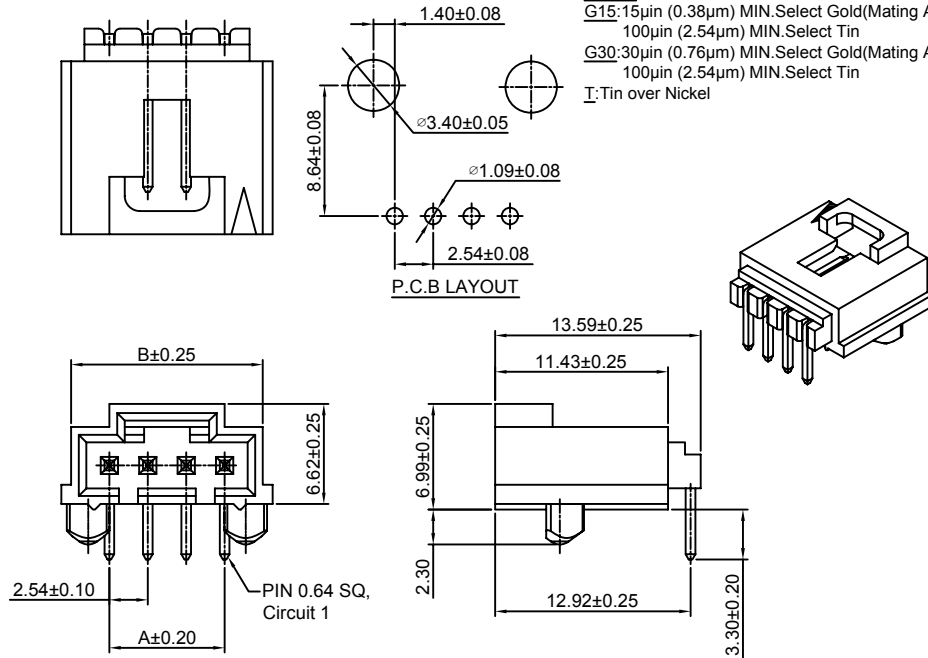

A2547WR-S-F-XP

2.54mm Pitch 90° Wafer-SMT TYPE

Reference Informations:

- *Material: Pin: Brass/Gold over Nickel
Insulator: Nylon 6T, UL94V-0
- *Mates with CJT A2547H-XP(-2,-3), A2547HA, HB-XP, A2550H-XP-(A,A1,A2,A3H,B,H,G,M,M1,M2), A2541H-XP series Housing
- *Color: Black

Ordering Information:
A2547WR-S-F-XP - *** - ***
1 2 3

- Part No.
- Material:
(Blank): Nylon 6T, UL94V-0
GWT: Nylon 6T, UL94V-0, GWT 750°C
- Finish:
(blank): Gold-flash
G15: 15µin (0.38µm) MIN. Select Gold (Mating Area)
100µin (2.54µm) MIN. Select Tin
G30: 30µin (0.76µm) MIN. Select Gold (Mating Area)
100µin (2.54µm) MIN. Select Tin
T: Tin over Nickel

Ordering Information & Dimensions:

PART NO.	Dimensions	
	A	B
2P	2.54	7.62
3P	5.08	10.16
4P	7.62	12.70
5P	10.16	15.24
6P	12.70	17.78
7P	15.24	20.32
8P	17.78	22.86
9P	20.32	25.40
10P	22.86	27.94
11P	25.40	30.48
12P	27.94	33.02
13P	30.48	35.56
14P	33.02	38.10
15P	35.56	40.64
16P	38.10	43.18
17P	40.64	45.72
18P	43.18	48.26
19P	45.72	50.80
20P	48.26	53.34
21P	50.80	55.88
22P	53.34	58.42
23P	55.88	60.96
24P	58.42	63.50
25P	60.96	66.04

Unit: mm

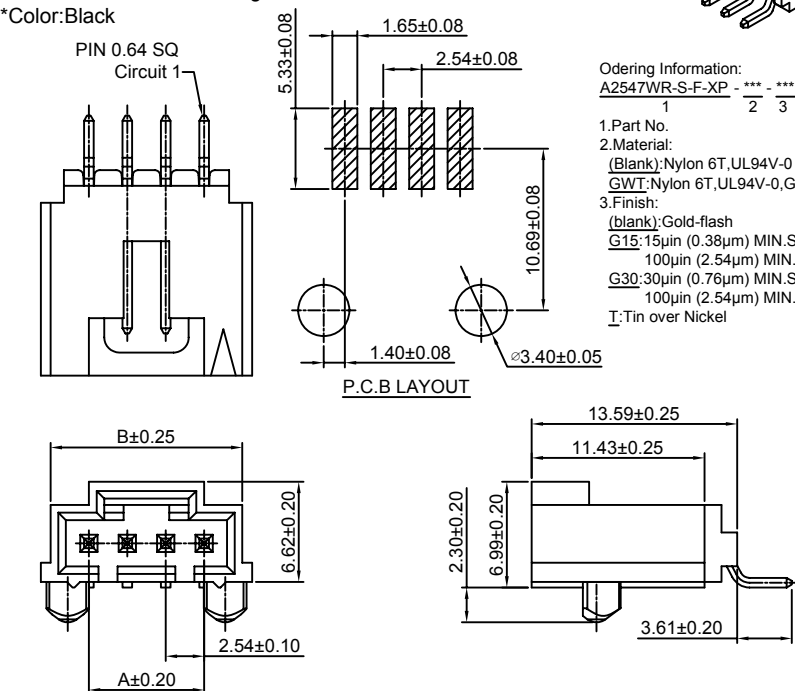

A2547WVA-XP

2.54mm Pitch 180° Wafer

Reference Informations:

*Material:Pin:Brass/Tin over Nickel
Insulator:PBT,UL94V-0

*Mates with CJT A2547H-XP(-2,-3),A2547HA,HB-XP, A2550H-XP-(A,A1,A2,A3H,B,H,G,M,M1,M2), A2541H-XP series Housing

*Color:Black



Ordering Information:

A2547WVA-XP - *** - ***
1 2 3

1.Part No.

2.Material:

(Blank):PBT,UL94V-0

6T:Nylon 6T,UL94V-0

GWT:PBT,UL94V-0,GWT 750 °C

3.Finish:

(Blank):Tin over Nickel

G:Gold-flash

G15:15µm (0.38µm) MIN.Select Gold(Mating Area)

100µm (2.54µm) MIN.Select Tin

G30:30µm (0.76µm) MIN.Select Gold(Mating Area)

100µm (2.54µm) MIN.Select Tin

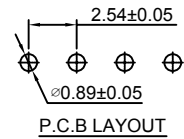

Ordering Information & Dimensions:

PART NO.	Dimensions		
	A	B	C
2P	2.54	7.62	5.59
3P	5.08	10.16	8.13
4P	7.62	12.70	10.67
5P	10.16	15.24	13.21
6P	12.70	17.78	15.75
7P	15.24	20.32	18.29
8P	17.78	22.86	20.83
9P	20.32	25.40	23.37
10P	22.86	27.94	25.91
11P	25.40	30.48	28.45
12P	27.94	33.02	30.99
13P	30.48	35.56	33.53
14P	33.02	38.10	36.07
15P	35.56	40.64	38.61
16P	38.10	43.18	41.15
17P	40.64	45.72	43.69
18P	43.18	48.26	46.23
19P	45.72	50.80	48.77
20P	48.26	53.34	51.31
21P	50.80	55.88	53.85
22P	53.34	58.42	56.39
23P	55.88	60.96	58.93
24P	58.42	63.50	61.47
25P	60.96	66.04	64.01

Unit: mm

A2547WRA-XP

2.54mm Pitch 90° Wafer

Reference Informations:

*Material:Pin:Brass/Tin over Nickel
Insulator:PBT,UL94V-0

*Mates with CJT A2547H-XP(-2,-3),A2547HA,HB-XP, A2550H-XP-(A,A1,A2,A3H,B,H,G,M,M1,M2), A2541H-XP series Housing

*Color:Black

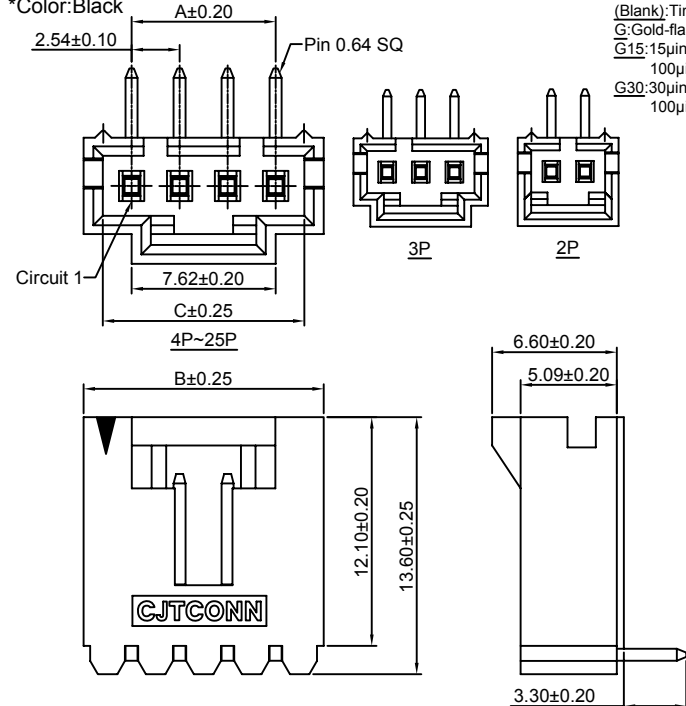

Ordering Information:

A2547WRA-XP - *** - ***
1 2 3

1.Part No.

2.Material:

(Blank):PBT,UL94V-0

6T:Nylon 6T,UL94V-0

GWT:PBT,UL94V-0,GWT 750 °C

3.Finish:

(Blank):Tin over Nickel

G:Gold-flash

G15:15µm (0.38µm) MIN.Select Gold(Mating Area)

100µm (2.54µm) MIN.Select Tin

G30:30µm (0.76µm) MIN.Select Gold(Mating Area)

100µm (2.54µm) MIN.Select Tin

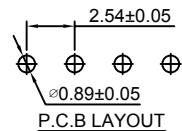

Ordering Information & Dimensions:

PART NO.	Dimensions		
	A	B	C
2P	2.54	7.62	5.59
3P	5.08	10.16	8.13
4P	7.62	12.70	10.67
5P	10.16	15.24	13.21
6P	12.70	17.78	15.75
7P	15.24	20.32	18.29
8P	17.78	22.86	20.83
9P	20.32	25.40	23.37
10P	22.86	27.94	25.91
11P	25.40	30.48	28.45
12P	27.94	33.02	30.99
13P	30.48	35.56	33.53
14P	33.02	38.10	36.07
15P	35.56	40.64	38.61
16P	38.10	43.18	41.15
17P	40.64	45.72	43.69
18P	43.18	48.26	46.23
19P	45.72	50.80	48.77
20P	48.26	53.34	51.31
21P	50.80	55.88	53.85
22P	53.34	58.42	56.39
23P	55.88	60.96	58.93
24P	58.42	63.50	61.47
25P	60.96	66.04	64.01

Unit: mm

A2547WVA-F1-XP

2.54mm Pitch 180° Wafer

Reference Informations:

- *Material: Pin: Brass/Tin over Nickel
Insulator: PBT, UL94V-0
- *Mates with CJT A2547H-XP(-2,-3), A2547HA, HB-XP, A2550H-XP-(A,A1,A2,A3H,B,H,G,M,M1,M2), A2541H-XP series Housing
- *Color: Black

Ordering Information:
A2547WVA-F1-XP - *** - ***
1 2 3

1. Part No.
2. Material:
(Blank): PBT, UL94V-0
6T: Nylon 6T, UL94V-0
GWT: PBT, UL94V-0, GWT 750°C
3. Finish:
(Blank): Tin over Nickel
G: Gold-flash
G15: 15µin (0.38µm) MIN. Select Gold (Mating Area)
100µin (2.54µm) MIN. Select Tin
G30: 30µin (0.76µm) MIN. Select Gold (Mating Area)
100µin (2.54µm) MIN. Select Tin



Ordering Information & Dimensions:

PART NO.	Dimensions		
	A	B	C
2P	2.54	7.62	5.59
3P	5.08	10.16	8.13
4P	7.62	12.70	10.67
5P	10.16	15.24	13.21
6P	12.70	17.78	15.75
7P	15.24	20.32	18.29
8P	17.78	22.86	20.83
9P	20.32	25.40	23.37
10P	22.86	27.94	25.91
11P	25.40	30.48	28.45
12P	27.94	33.02	30.99
13P	30.48	35.56	33.53
14P	33.02	38.10	36.07
15P	35.56	40.64	38.61
16P	38.10	43.18	41.15
17P	40.64	45.72	43.69
18P	43.18	48.26	46.23
19P	45.72	50.80	48.77
20P	48.26	53.34	51.31
21P	50.80	55.88	53.85
22P	53.34	58.42	56.39
23P	55.88	60.96	58.93
24P	58.42	63.50	61.47
25P	60.96	66.04	64.01

Unit: mm

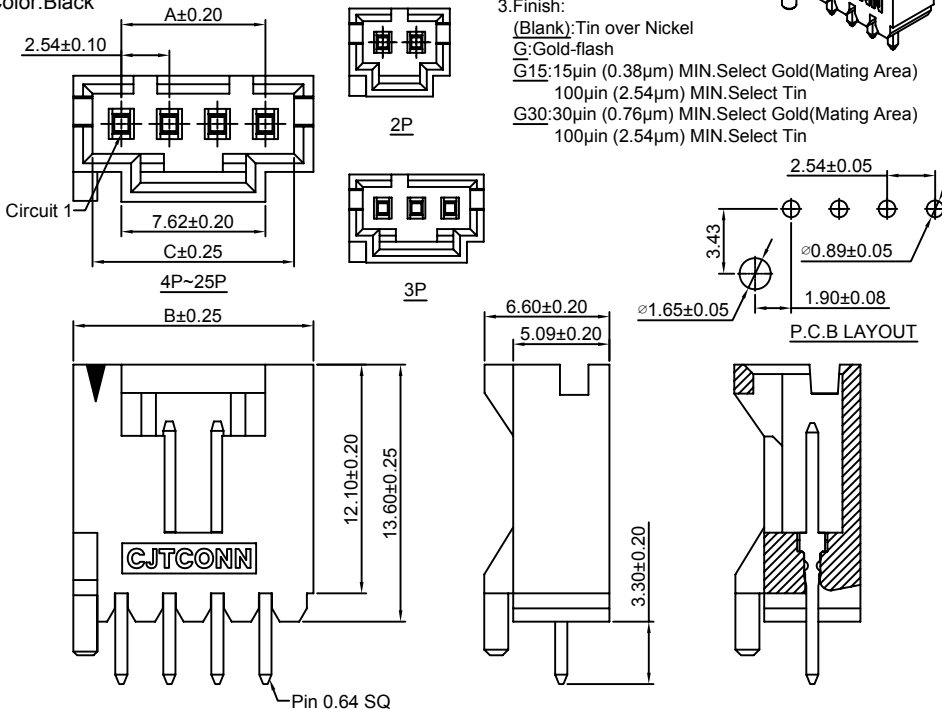

A2547WRA-F1-XP

2.54mm Pitch 90° Wafer

Reference Informations:

- *Material: Pin: Brass/Tin over Nickel
Insulator: PBT, UL94V-0
- *Mates with CJT A2547H-XP(-2,-3), A2547HA, HB-XP, A2550H-XP-(A,A1,A2,A3H,B,H,G,M,M1,M2), A2541H-XP series Housing
- *Color: Black

Ordering Information:
A2547WRA-F1-XP - *** - ***
1 2 3

1. Part No.
2. Material:
(Blank): PBT, UL94V-0
6T: Nylon 6T, UL94V-0
GWT: PBT, UL94V-0, GWT 750°C
3. Finish:
(Blank): Tin over Nickel
G: Gold-flash
G15: 15µin (0.38µm) MIN. Select Gold (Mating Area)
100µin (2.54µm) MIN. Select Tin
G30: 30µin (0.76µm) MIN. Select Gold (Mating Area)
100µin (2.54µm) MIN. Select Tin



Ordering Information & Dimensions:

PART NO.	Dimensions		
	A	B	C
2P	2.54	7.62	5.59
3P	5.08	10.16	8.13
4P	7.62	12.70	10.67
5P	10.16	15.24	13.21
6P	12.70	17.78	15.75
7P	15.24	20.32	18.29
8P	17.78	22.86	20.83
9P	20.32	25.40	23.37
10P	22.86	27.94	25.91
11P	25.40	30.48	28.45
12P	27.94	33.02	30.99
13P	30.48	35.56	33.53
14P	33.02	38.10	36.07
15P	35.56	40.64	38.61
16P	38.10	43.18	41.15
17P	40.64	45.72	43.69
18P	43.18	48.26	46.23
19P	45.72	50.80	48.77
20P	48.26	53.34	51.31
21P	50.80	55.88	53.85
22P	53.34	58.42	56.39
23P	55.88	60.96	58.93
24P	58.42	63.50	61.47
25P	60.96	66.04	64.01

Unit: mm

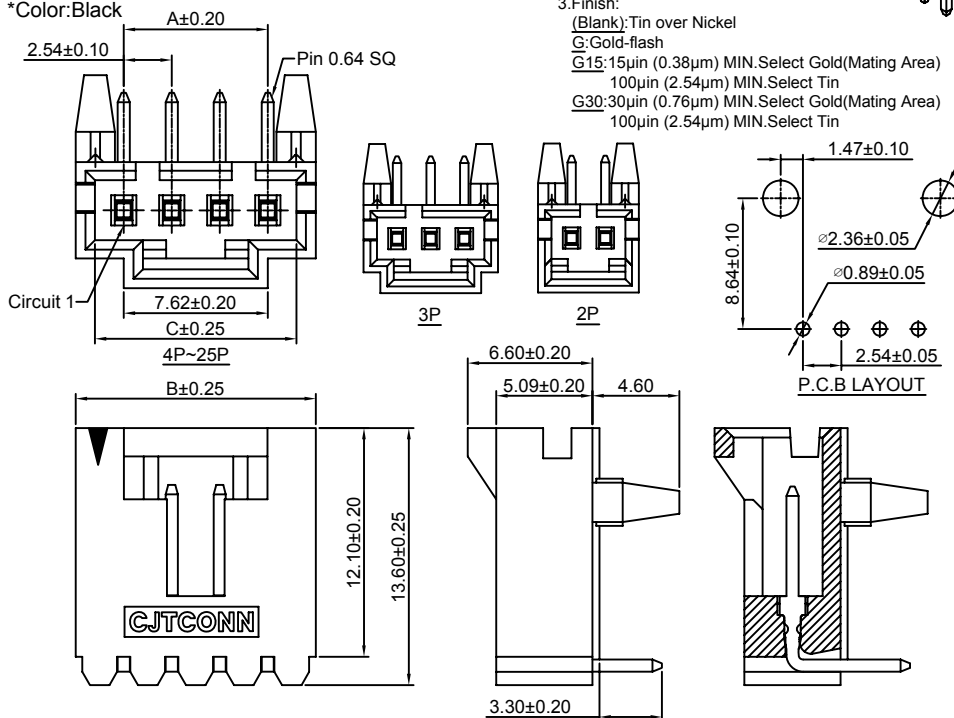

A2547WRA-FJ-XP

2.54mm Pitch 90° Wafer

Reference Informations:

- *Material: Pin: Brass/Tin over Nickel
Insulator: PBT, UL94V-0
- *Mates with CJT A2547H-XP(-2,-3), A2547HA, HB-XP, A2550H-XP-(A,A1,A2,A3H,B,H,G,M,M1,M2), A2541H-XP series Housing
- *Color: Black

- Odering Information:
A2547WRA-FJ-XP - *** - ***
1 2 3
- Part No.
 - Material:
(Blank): PBT, UL94V-0
6T: Nylon 6T, UL94V-0
GWT: PBT, UL94V-0, GWT 750°C
 - Finish:
(Blank): Tin over Nickel
G: Gold-flash
G15: 15µin (0.38µm) MIN. Select Gold (Mating Area)
100µin (2.54µm) MIN. Select Tin
G30: 30µin (0.76µm) MIN. Select Gold (Mating Area)
100µin (2.54µm) MIN. Select Tin

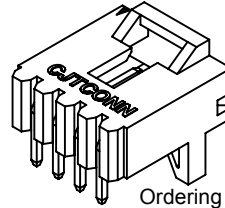

Ordering Information & Dimensions:

PART NO.	Dimensions		
	A	B	C
2P	2.54	7.62	5.59
3P	5.08	10.16	8.13
4P	7.62	12.70	10.67
5P	10.16	15.24	13.21
6P	12.70	17.78	15.75
7P	15.24	20.32	18.29
8P	17.78	22.86	20.83
9P	20.32	25.40	23.37
10P	22.86	27.94	25.91
11P	25.40	30.48	28.45
12P	27.94	33.02	30.99
13P	30.48	35.56	33.53
14P	33.02	38.10	36.07
15P	35.56	40.64	38.61
16P	38.10	43.18	41.15
17P	40.64	45.72	43.69
18P	43.18	48.26	46.23
19P	45.72	50.80	48.77
20P	48.26	53.34	51.31
21P	50.80	55.88	53.85
22P	53.34	58.42	56.39
23P	55.88	60.96	58.93
24P	58.42	63.50	61.47
25P	60.96	66.04	64.01

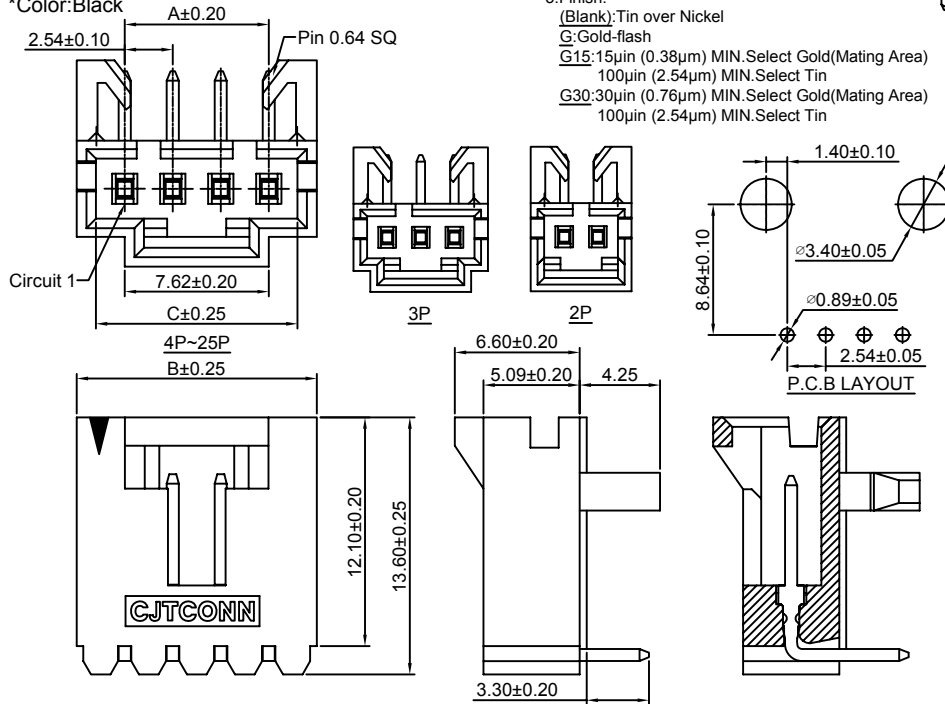

Unit: mm

A2547WVA-F-XP

2.54mm Pitch 180° Wafer

Reference Informations:

- *Material: Pin: Brass/Tin over Nickel
Insulator: PBT, UL94V-0
- *Mates with CJT A2547H-XP(-2,-3), A2547HA, HB-XP, A2550H-XP-(A,A1,A2,A3H,B,H,G,M,M1,M2), A2541H-XP series Housing
- *Color: Black

- Odering Information:
A2547WVA-F-XP - *** - ***
1 2 3
- Part No.
 - Material:
(Blank): PBT, UL94V-0
6T: Nylon 6T, UL94V-0
GWT: PBT, UL94V-0, GWT 750°C
 - Finish:
(Blank): Tin over Nickel
G: Gold-flash
G15: 15µin (0.38µm) MIN. Select Gold (Mating Area)
100µin (2.54µm) MIN. Select Tin
G30: 30µin (0.76µm) MIN. Select Gold (Mating Area)
100µin (2.54µm) MIN. Select Tin

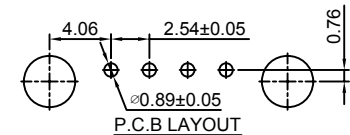
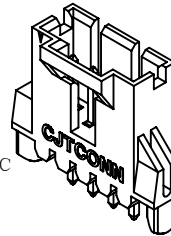

Ordering Information & Dimensions:

PART NO.	Dimensions		
	A	B	C
2P	2.54	7.62	5.59
3P	5.08	10.16	8.13
4P	7.62	12.70	10.67
5P	10.16	15.24	13.21
6P	12.70	17.78	15.75
7P	15.24	20.32	18.29
8P	17.78	22.86	20.83
9P	20.32	25.40	23.37
10P	22.86	27.94	25.91
11P	25.40	30.48	28.45
12P	27.94	33.02	30.99
13P	30.48	35.56	33.53
14P	33.02	38.10	36.07
15P	35.56	40.64	38.61
16P	38.10	43.18	41.15
17P	40.64	45.72	43.69
18P	43.18	48.26	46.23
19P	45.72	50.80	48.77
20P	48.26	53.34	51.31
21P	50.80	55.88	53.85
22P	53.34	58.42	56.39
23P	55.88	60.96	58.93
24P	58.42	63.50	61.47
25P	60.96	66.04	64.01

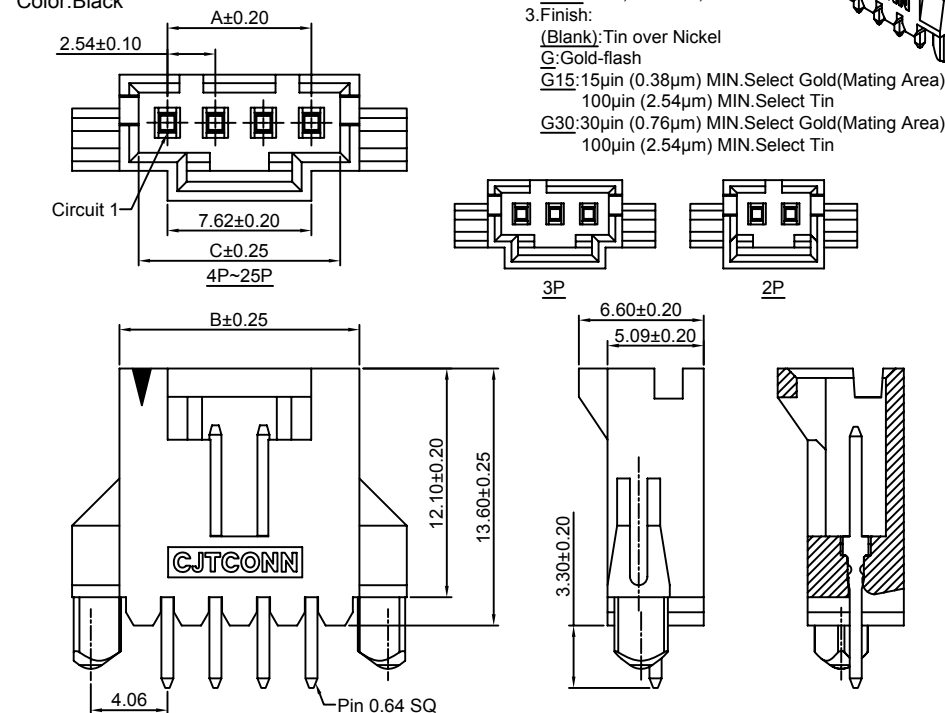

Unit: mm

A2547WRA-F-XP

2.54mm Pitch 90° Wafer

Reference Informations:

- *Material: Pin: Brass/Tin over Nickel
Insulator: PBT, UL94V-0
- *Mates with CJT A2547H-XP(-2,-3), A2547HA, HB-XP, A2550H-XP-(A,A1,A2,A3H,B,H,G,M,M1,M2), A2541H-XP series Housing
- *Color: Black

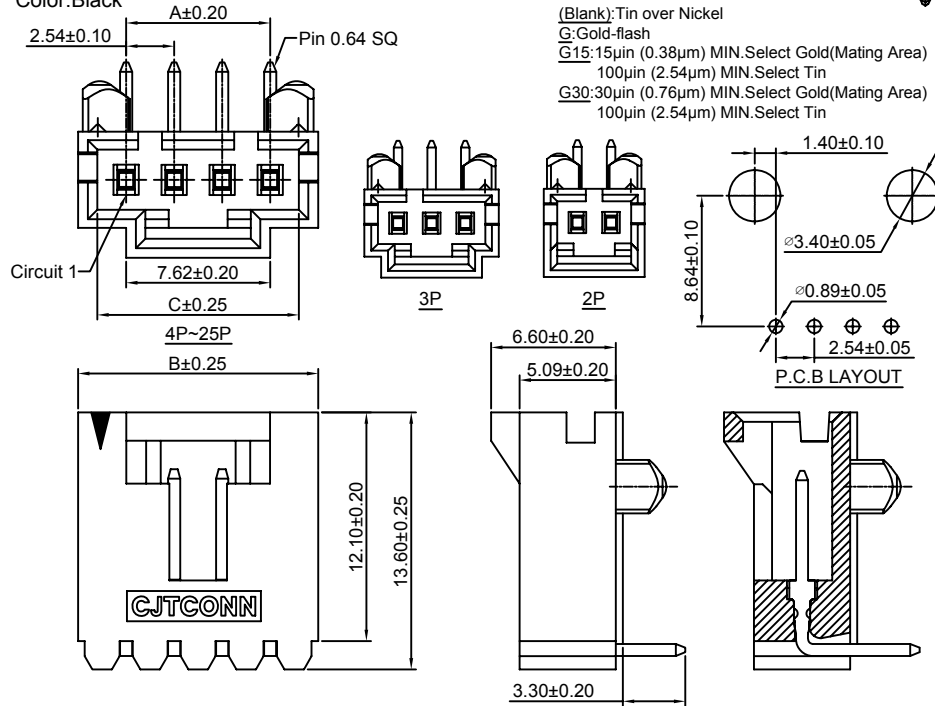

Odering Information:
A2547WRA-F-XP - *** - ***
1 2 3

- 1.Part No.
- 2.Material:
(Blank): PBT, UL94V-0
6T: Nylon 6T, UL94V-0
GWT: PBT, UL94V-0, GWT 750°C
- 3.Finish:
(Blank): Tin over Nickel
G: Gold-flash
G15: 15µin (0.38µm) MIN. Select Gold (Mating Area)
100µin (2.54µm) MIN. Select Tin
G30: 30µin (0.76µm) MIN. Select Gold (Mating Area)
100µin (2.54µm) MIN. Select Tin

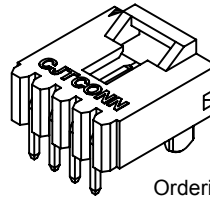

Ordering Information & Dimensions:

PART NO.	Dimensions		
	A	B	C
2P	2.54	7.62	5.59
3P	5.08	10.16	8.13
4P	7.62	12.70	10.67
5P	10.16	15.24	13.21
6P	12.70	17.78	15.75
7P	15.24	20.32	18.29
8P	17.78	22.86	20.83
9P	20.32	25.40	23.37
10P	22.86	27.94	25.91
11P	25.40	30.48	28.45
12P	27.94	33.02	30.99
13P	30.48	35.56	33.53
14P	33.02	38.10	36.07
15P	35.56	40.64	38.61
16P	38.10	43.18	41.15
17P	40.64	45.72	43.69
18P	43.18	48.26	46.23
19P	45.72	50.80	48.77
20P	48.26	53.34	51.31
21P	50.80	55.88	53.85
22P	53.34	58.42	56.39
23P	55.88	60.96	58.93
24P	58.42	63.50	61.47
25P	60.96	66.04	64.01

Unit: mm

A2547WVA-F2-XP

2.54mm Pitch 180° Wafer

Reference Informations:

- *Material: Pin: Brass/Tin over Nickel
Insulator: PBT, UL94V-0
- *Mates with CJT A2547H-XP(-2,-3), A2547HA, HB-XP, A2550H-XP-(A,A1,A2,A3H,B,H,G,M,M1,M2), A2541H-XP series Housing
- *Color: Black



Odering Information:
A2547WVA-F2-XP - *** - ***
1 2 3

- 1.Part No.
- 2.Material:
(Blank): PBT, UL94V-0
6T: Nylon 6T, UL94V-0
GWT: PBT, UL94V-0, GWT 750°C
- 3.Finish:
(Blank): Tin over Nickel
G: Gold-flash
G15: 15µin (0.38µm) MIN. Select Gold (Mating Area)
100µin (2.54µm) MIN. Select Tin
G30: 30µin (0.76µm) MIN. Select Gold (Mating Area)
100µin (2.54µm) MIN. Select Tin

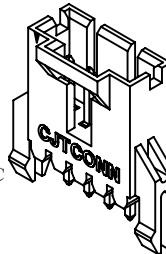

Ordering Information & Dimensions:

PART NO.	Dimensions		
	A	B	C
2P	2.54	7.62	5.59
3P	5.08	10.16	8.13
4P	7.62	12.70	10.67
5P	10.16	15.24	13.21
6P	12.70	17.78	15.75
7P	15.24	20.32	18.29
8P	17.78	22.86	20.83
9P	20.32	25.40	23.37
10P	22.86	27.94	25.91
11P	25.40	30.48	28.45
12P	27.94	33.02	30.99
13P	30.48	35.56	33.53
14P	33.02	38.10	36.07
15P	35.56	40.64	38.61
16P	38.10	43.18	41.15
17P	40.64	45.72	43.69
18P	43.18	48.26	46.23
19P	45.72	50.80	48.77
20P	48.26	53.34	51.31
21P	50.80	55.88	53.85
22P	53.34	58.42	56.39
23P	55.88	60.96	58.93
24P	58.42	63.50	61.47
25P	60.96	66.04	64.01

Unit: mm

A2547WRA-F2-XP

2.54mm Pitch 90° Wafer

Reference Informations:

- *Material: Pin: Brass/Tin over Nickel
Insulator: PBT, UL94V-0
- *Mates with CJT A2547H-XP(-2,-3), A2547HA, HB-XP, A2550H-XP-(A,A1,A2,A3H,B,H,G,M,M1,M2), A2541H-XP series Housing
- *Color: Black

Odering Information:
A2547WRA-F2-XP - *** - ***
1 2 3

- Part No.
- Material:
(Blank): PBT, UL94V-0
6T: Nylon 6T, UL94V-0
GWT: PBT, UL94V-0, GWT 750°C
- Finish:
(Blank): Tin over Nickel
G: Gold-flash
G15: 15µin (0.38µm) MIN. Select Gold (Mating Area)
100µin (2.54µm) MIN. Select Tin
G30: 30µin (0.76µm) MIN. Select Gold (Mating Area)
100µin (2.54µm) MIN. Select Tin

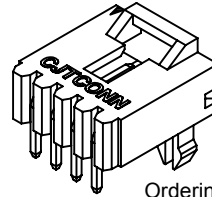

Ordering Information & Dimensions:

PART NO.	Dimensions		
	A	B	C
2P	2.54	7.62	5.59
3P	5.08	10.16	8.13
4P	7.62	12.70	10.67
5P	10.16	15.24	13.21
6P	12.70	17.78	15.75
7P	15.24	20.32	18.29
8P	17.78	22.86	20.83
9P	20.32	25.40	23.37
10P	22.86	27.94	25.91
11P	25.40	30.48	28.45
12P	27.94	33.02	30.99
13P	30.48	35.56	33.53
14P	33.02	38.10	36.07
15P	35.56	40.64	38.61
16P	38.10	43.18	41.15
17P	40.64	45.72	43.69
18P	43.18	48.26	46.23
19P	45.72	50.80	48.77
20P	48.26	53.34	51.31
21P	50.80	55.88	53.85
22P	53.34	58.42	56.39
23P	55.88	60.96	58.93
24P	58.42	63.50	61.47
25P	60.96	66.04	64.01

Unit: mm

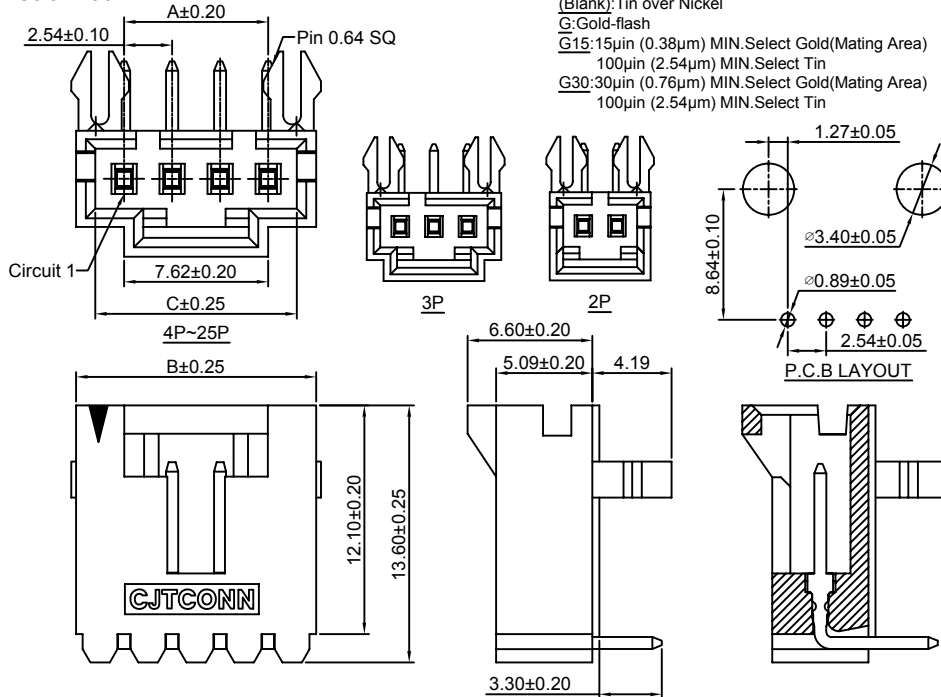

A2547WRA-S-F-XP

2.54mm Pitch 90° Wafer - SMT TYPE

Reference Informations:

- *Material: Pin: Brass/Tin over Nickel
Insulator: LCP, UL94V-0
- *Mates with CJT A2547H-XP(-2,-3), A2547HA, HB-XP, A2550H-XP-(A,A1,A2,A3H,B,H,G,M,M1,M2), A2541H-XP series Housing
- *Color: Black

Odering Information:
A2547WRA-S-F-XP - *** - ***
1 2 3

- Part No.
- Material:
(Blank): LCP, UL94V-0
6T: Nylon 6T, UL94V-0
GWT: LCP, UL94V-0, GWT 750°C
- Finish:
(Blank): Tin over Nickel
G: Gold-flash
G15: 15µin (0.38µm) MIN. Select Gold (Mating Area)
100µin (2.54µm) MIN. Select Tin
G30: 30µin (0.76µm) MIN. Select Gold (Mating Area)
100µin (2.54µm) MIN. Select Tin

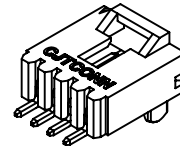

Ordering Information & Dimensions:

PART NO.	Dimensions		
	A	B	C
2P	2.54	7.62	5.59
3P	5.08	10.16	8.13
4P	7.62	12.70	10.67
5P	10.16	15.24	13.21
6P	12.70	17.78	15.75
7P	15.24	20.32	18.29
8P	17.78	22.86	20.83
9P	20.32	25.40	23.37
10P	22.86	27.94	25.91
11P	25.40	30.48	28.45
12P	27.94	33.02	30.99
13P	30.48	35.56	33.53
14P	33.02	38.10	36.07
15P	35.56	40.64	38.61
16P	38.10	43.18	41.15
17P	40.64	45.72	43.69
18P	43.18	48.26	46.23
19P	45.72	50.80	48.77
20P	48.26	53.34	51.31
21P	50.80	55.88	53.85
22P	53.34	58.42	56.39
23P	55.88	60.96	58.93
24P	58.42	63.50	61.47
25P	60.96	66.04	64.01

Unit: mm

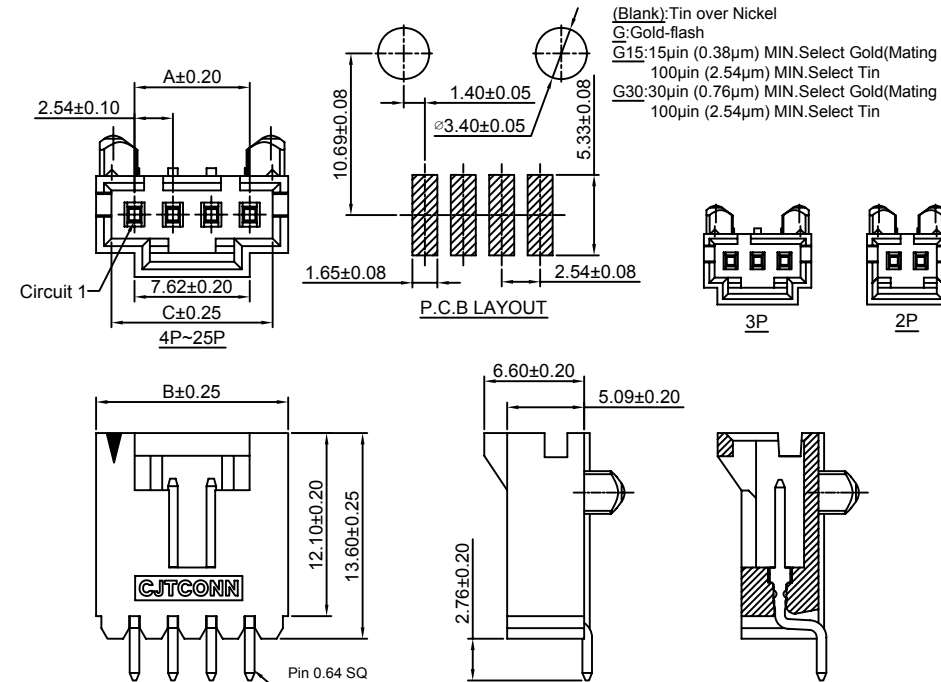

A2547WVE-XP

2.54mm Pitch 180° Wafer

Reference Informations:

- *Material: Pin: Brass/Tin over Nickel
Insulator: PBT, UL94V-0
- *Mates with CJT A2549H, HA-XP, A2550H-XP-C
A2550H-XP-C1, A2550H-XP-I series Housing
- *Color: Black

Ordering Information:
A2547WVE-XP - *** - ***
1 2 3

- Part No.
- Material:
(blank): PBT, UL94V-0
6T: Nylon 6T, UL94V-0
GWT: PBT, UL94V-0, GWT 750 °C
- Finish:
(Blank): Tin over Nickel
G: Gold-flash
G15: 15µin (0.38µm) MIN. Select Gold (Mating Area)
100µin (2.54µm) MIN. Select Tin
G30: 30µin (0.76µm) MIN. Select Gold (Mating Area)
100µin (2.54µm) MIN. Select Tin

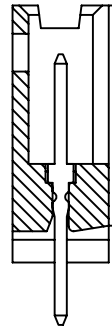
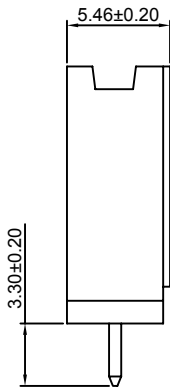
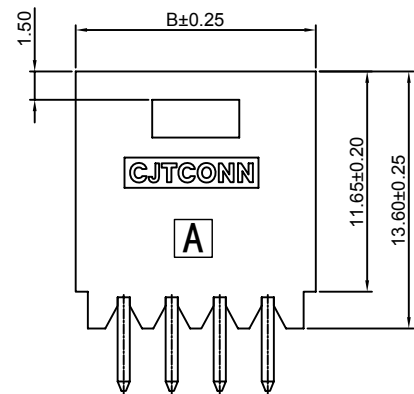
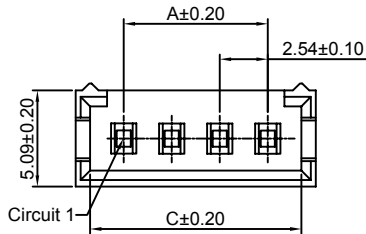
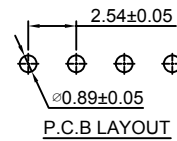
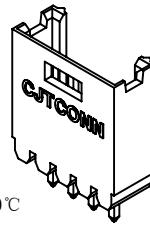

Ordering Information & Dimensions:

PART NO.	Dimensions		
	A	B	C
2P	2.54	7.62	5.59
3P	5.08	10.16	8.13
4P	7.62	12.70	10.67
5P	10.16	15.24	13.21
6P	12.70	17.78	15.75
7P	15.24	20.32	18.29
8P	17.78	22.86	20.83
9P	20.32	25.40	23.37
10P	22.86	27.94	25.91
11P	25.40	30.48	28.45
12P	27.94	33.02	30.99
13P	30.48	35.56	33.53
14P	33.02	38.10	36.07
15P	35.56	40.64	38.61
16P	38.10	43.18	41.15
17P	40.64	45.72	43.69
18P	43.18	48.26	46.23
19P	45.72	50.80	48.77
20P	48.26	53.34	51.31
21P	50.80	55.88	53.85
22P	53.34	58.42	56.39
23P	55.88	60.96	58.93
24P	58.42	63.50	61.47
25P	60.96	66.04	64.01

Unit: mm

A2547WRE-XP

2.54mm Pitch 90° Wafer

Reference Informations:

- *Material: Pin: Brass/Tin over Nickel
Insulator: PBT, UL94V-0
- *Mates with CJT A2549H, HA-XP, A2550H-XP-C
A2550H-XP-C1, A2550H-XP-I series Housing
- *Color: Black

Ordering Information:
A2547WRE-XP - *** - ***
1 2 3

- Part No.
- Material:
(blank): PBT, UL94V-0
6T: Nylon 6T, UL94V-0
GWT: PBT, UL94V-0, GWT 750 °C
- Finish:
(Blank): Tin over Nickel
G: Gold-flash
G15: 15µin (0.38µm) MIN. Select Gold (Mating Area)
100µin (2.54µm) MIN. Select Tin
G30: 30µin (0.76µm) MIN. Select Gold (Mating Area)
100µin (2.54µm) MIN. Select Tin

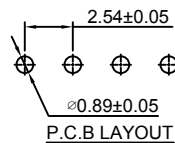
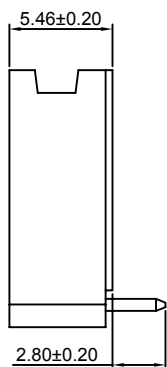
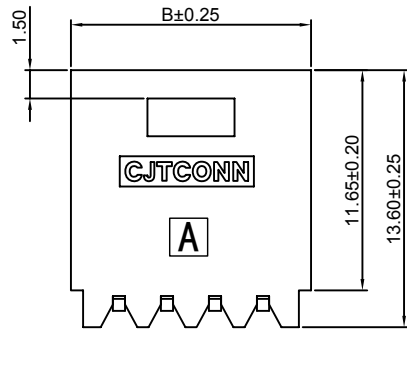
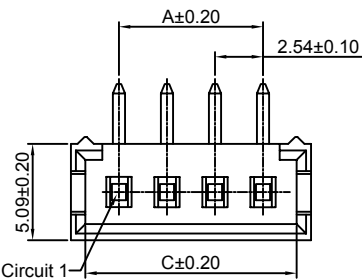
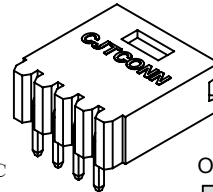

P.C.B LAYOUT

Ordering Information & Dimensions:

PART NO.	Dimensions		
	A	B	C
2P	2.54	7.62	5.59
3P	5.08	10.16	8.13
4P	7.62	12.70	10.67
5P	10.16	15.24	13.21
6P	12.70	17.78	15.75
7P	15.24	20.32	18.29
8P	17.78	22.86	20.83
9P	20.32	25.40	23.37
10P	22.86	27.94	25.91
11P	25.40	30.48	28.45
12P	27.94	33.02	30.99
13P	30.48	35.56	33.53
14P	33.02	38.10	36.07
15P	35.56	40.64	38.61
16P	38.10	43.18	41.15
17P	40.64	45.72	43.69
18P	43.18	48.26	46.23
19P	45.72	50.80	48.77
20P	48.26	53.34	51.31
21P	50.80	55.88	53.85
22P	53.34	58.42	56.39
23P	55.88	60.96	58.93
24P	58.42	63.50	61.47
25P	60.96	66.04	64.01

Unit: mm

A2547WVF-XP

2.54mm Pitch 180° Wafer

Reference Informations:

- *Material: Pin: Brass/Tin over Nickel
Insulator: PBT, UL94V-0
- *Mates with CJT A2549HD-XP series
Single Row Housing
- *Color: Black

Ordering Information:

A2547WVF-XP - *** - ***
1 2 3

- Part No.
- Material:
(Blank): PBT, UL94V-0
6T: Nylon 6T, UL94V-0
GWT: PBT, UL94V-0, GWT 750°C
- Finish:
(Blank): Tin over Nickel
G: Gold-flash
G15: 15µin (0.38µm) MIN. Select Gold (Mating Area)
100µin (2.54µm) MIN. Select Tin
G30: 30µin (0.76µm) MIN. Select Gold (Mating Area)
100µin (2.54µm) MIN. Select Tin

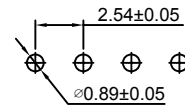

P.C.B LAYOUT

Ordering Information & Dimensions:

PART NO.	Dimensions		
	A	B	C
3P	5.08	10.16	8.13
4P	7.62	12.70	10.67
5P	10.16	15.24	13.21
6P	12.70	17.78	15.75
7P	15.24	20.32	18.29
8P	17.78	22.86	20.83
9P	20.32	25.40	23.37
10P	22.86	27.94	25.91
11P	25.40	30.48	28.45
12P	27.94	33.02	30.99
13P	30.48	35.56	33.53
14P	33.02	38.10	36.07
15P	35.56	40.64	38.61
16P	38.10	43.18	41.15
17P	40.64	45.72	43.69
18P	43.18	48.26	46.23
19P	45.72	50.80	48.77
20P	48.26	53.34	51.31
21P	50.80	55.88	53.85
22P	53.34	58.42	56.39
23P	55.88	60.96	58.93
24P	58.42	63.50	61.47
25P	60.96	66.04	64.01

Unit: mm

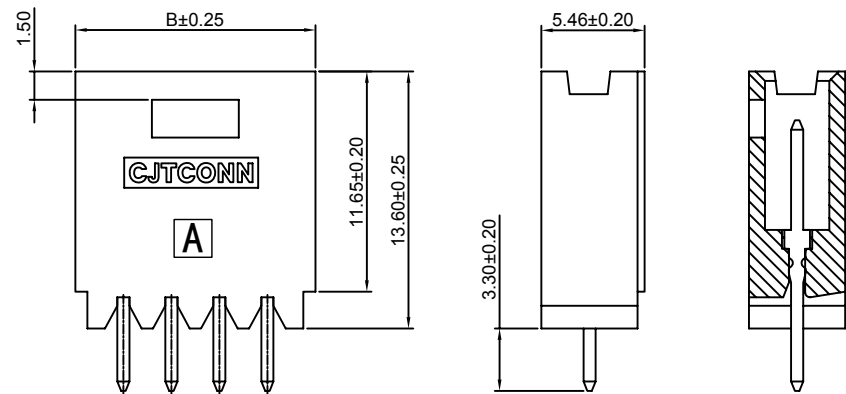
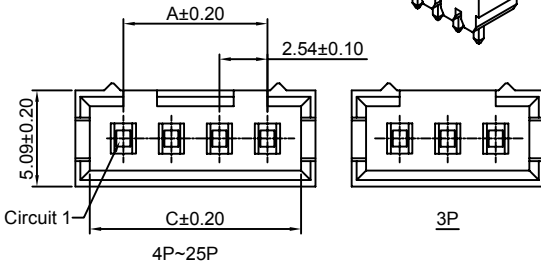

A2547WRF-XP

2.54mm Pitch 90° Wafer

Reference Informations:

- *Material: Pin: Brass/Tin over Nickel
Insulator: PBT, UL94V-0
- *Mates with CJT A2549HD-XP series
Single Row Housing
- *Color: Black

Ordering Information:

A2547WRF-XP - *** - ***
1 2 3

- Part No.
- Material:
(Blank): PBT, UL94V-0
6T: Nylon 6T, UL94V-0
GWT: PBT, UL94V-0, GWT 750°C
- Finish:
(Blank): Tin over Nickel
G: Gold-flash
G15: 15µin (0.38µm) MIN. Select Gold (Mating Area)
100µin (2.54µm) MIN. Select Tin
G30: 30µin (0.76µm) MIN. Select Gold (Mating Area)
100µin (2.54µm) MIN. Select Tin

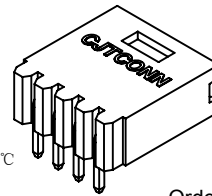

Ordering Information & Dimensions:

PART NO.	Dimensions		
	A	B	C
3P	5.08	10.16	8.13
4P	7.62	12.70	10.67
5P	10.16	15.24	13.21
6P	12.70	17.78	15.75
7P	15.24	20.32	18.29
8P	17.78	22.86	20.83
9P	20.32	25.40	23.37
10P	22.86	27.94	25.91
11P	25.40	30.48	28.45
12P	27.94	33.02	30.99
13P	30.48	35.56	33.53
14P	33.02	38.10	36.07
15P	35.56	40.64	38.61
16P	38.10	43.18	41.15
17P	40.64	45.72	43.69
18P	43.18	48.26	46.23
19P	45.72	50.80	48.77
20P	48.26	53.34	51.31
21P	50.80	55.88	53.85
22P	53.34	58.42	56.39
23P	55.88	60.96	58.93
24P	58.42	63.50	61.47
25P	60.96	66.04	64.01

Unit: mm

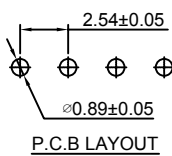
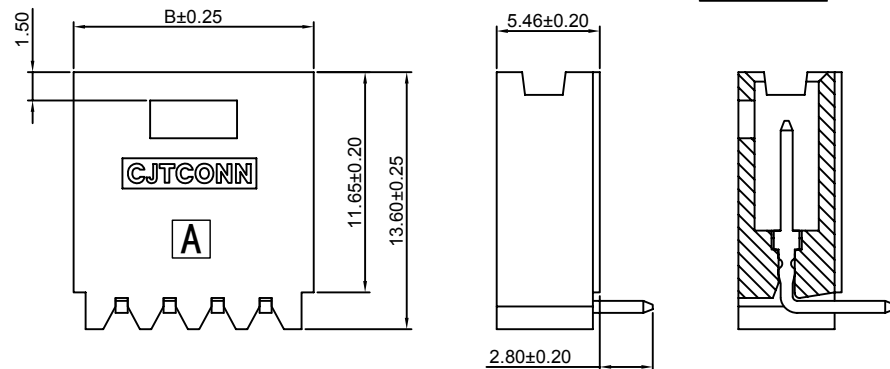
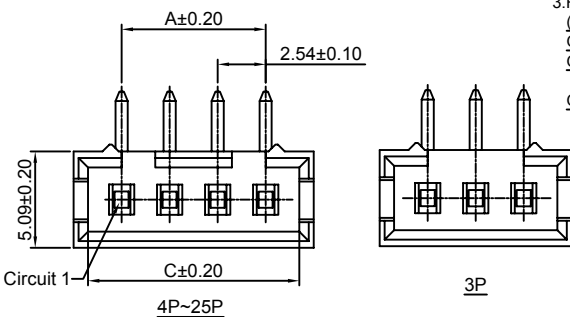

P.C.B LAYOUT

A2547WRE-S-XP

2.54mm Pitch 90° Wafer - SMT TYPE

Reference Informations:

- *Material: Pin: Brass/Tin over Nickel
Insulator: LCP, UL94V-0
- *Mates with CJT A2549H, HA-XP, A2550H-XP-C, A2550H-XP-C1 series Housing
- *Color: Black

Ordering Information:

A2547WRE-S-XP - *** - ***
1 2 3

1. Part No.
2. Material:
(Blank): LCP, UL94V-0
6T: Nylon 6T, UL94V-0
GWT: LCP, UL94V-0, GWT 750°C
3. Finish:
(Blank): Tin over Nickel
G: Gold-flash
G15: 15µin (0.38µm) MIN. Select Gold (Mating Area)
100µin (2.54µm) MIN. Select Tin
G30: 30µin (0.76µm) MIN. Select Gold (Mating Area)
100µin (2.54µm) MIN. Select Tin

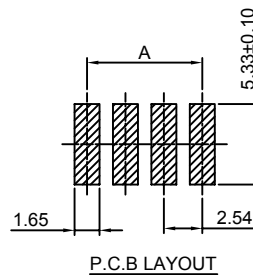
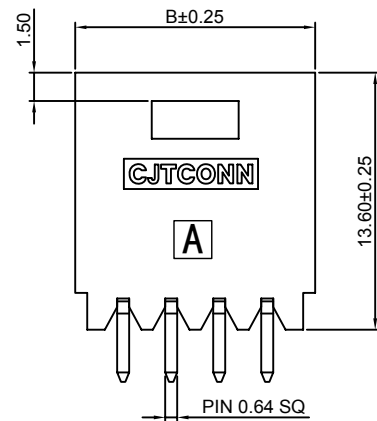

Ordering Information & Dimensions:

PART NO.	Dimensions	
	A	B
2P	2.54	7.62
3P	5.08	10.16
4P	7.62	12.70
5P	10.16	15.24
6P	12.70	17.78
7P	15.24	20.32
8P	17.78	22.86
9P	20.32	25.40
10P	22.86	27.94
11P	25.40	30.48
12P	27.94	33.02
13P	30.48	35.56
14P	33.02	38.10
15P	35.56	40.64
16P	38.10	43.18
17P	40.64	45.72
18P	43.18	48.26
19P	45.72	50.80
20P	48.26	53.34
21P	50.80	55.88
22P	53.34	58.42
23P	55.88	60.96
24P	58.42	63.50
25P	60.96	66.04

Unit: mm

A2547WRF-S-XP

2.54mm Pitch 90° Wafer - SMT TYPE

Reference Informations:

- *Material: Pin: Brass/Tin over Nickel
Insulator: LCP, UL94V-0
- *Mates with CJT A2549HD-XP series Single Row Housing
- *Color: Black

Ordering Information:

A2547WRF-S-XP - *** - ***
1 2 3

1. Part No.
2. Material:
(Blank): LCP, UL94V-0
6T: Nylon 6T, UL94V-0
GWT: LCP, UL94V-0, GWT 750°C
3. Finish:
(Blank): Tin over Nickel
G: Gold-flash
G15: 15µin (0.38µm) MIN. Select Gold (Mating Area)
100µin (2.54µm) MIN. Select Tin
G30: 30µin (0.76µm) MIN. Select Gold (Mating Area)
100µin (2.54µm) MIN. Select Tin



4P~25P

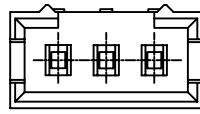

3P

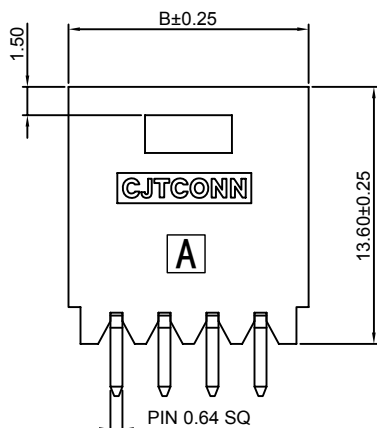

Ordering Information & Dimensions:

PART NO.	Dimensions	
	A	B
2P	2.54	7.62
3P	5.08	10.16
4P	7.62	12.70
5P	10.16	15.24
6P	12.70	17.78
7P	15.24	20.32
8P	17.78	22.86
9P	20.32	25.40
10P	22.86	27.94
11P	25.40	30.48
12P	27.94	33.02
13P	30.48	35.56
14P	33.02	38.10
15P	35.56	40.64
16P	38.10	43.18
17P	40.64	45.72
18P	43.18	48.26
19P	45.72	50.80
20P	48.26	53.34
21P	50.80	55.88
22P	53.34	58.42
23P	55.88	60.96
24P	58.42	63.50
25P	60.96	66.04

Unit: mm

A2547WVB-XP

2.54mm Pitch 180° Box Header

Reference Informations:

- *Material: Pin: Brass/Gold over Nickel
Insulator: PBT, UL94V-0
- *Mates with CJT A2547HJ-XP series
Single Row Housing
- *Color: Black

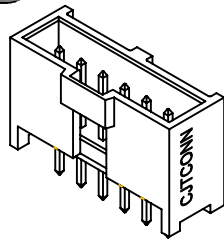

- Ordering Information:
A2547WVB-XP - *** - ***
- | | | |
|---|---|---|
| 1 | 2 | 3 |
|---|---|---|
- Part No.
 - Material:
(Blank): PBT, UL94V-0
6T: Nylon 6T, UL94V-0
GWT: PBT, UL94V-0, GWT 750 °C
 - Finish:
(Blank): Gold-flash
G15: 15µin (0.38µm) MIN. Select Gold (Mating Area)
100µin (2.54µm) MIN. Select Tin
G30: 30µin (0.76µm) MIN. Select Gold (Mating Area)
100µin (2.54µm) MIN. Select Tin
I: Tin over Nickel

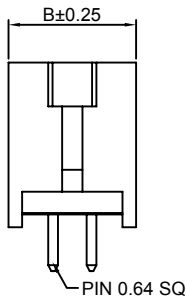
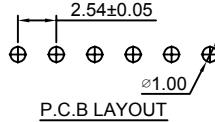
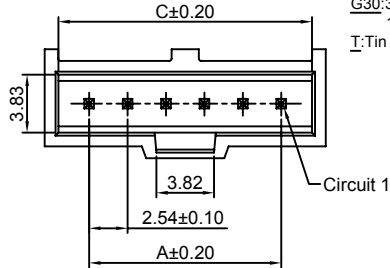

2P~3P

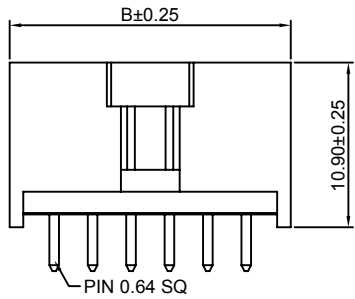

4P~32P

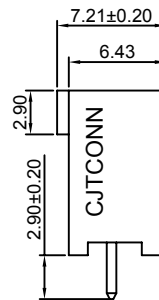

Ordering Information & Dimensions:

PART NO.	Dimensions		
	A	B	C
2P	2.54	8.43	6.60
3P	5.08	10.97	9.14
4P	7.62	13.51	11.68
5P	10.16	16.05	14.22
6P	12.70	18.59	16.76
7P	15.24	21.13	19.30
8P	17.78	23.67	21.84
9P	20.32	26.21	24.38
10P	22.86	28.75	26.92
11P	25.40	31.29	29.46
12P	27.94	33.83	32.00
13P	30.48	36.37	34.54
14P	33.02	38.91	37.08
15P	35.56	41.45	39.62
16P	38.10	43.99	42.16
17P	40.64	46.53	44.70
18P	43.18	49.07	47.24
19P	45.72	51.61	49.78
20P	48.26	54.15	52.32
21P	50.80	56.69	54.86
22P	53.34	59.23	57.40
23P	55.88	61.77	59.94
24P	58.42	64.31	62.48
25P	60.96	66.85	65.02
26P	63.50	69.39	67.56
27P	66.04	71.93	70.10
28P	68.58	74.47	72.64
29P	71.12	77.01	75.18
30P	73.66	79.55	77.72
31P	76.20	82.09	80.26
32P	78.74	84.63	82.80

Unit: mm

A2547WRB-XP

2.54mm Pitch 90° Box Header

Reference Informations:

- *Material: Pin: Brass/Gold over Nickel
Insulator: PBT, UL94V-0
- *Mates with CJT A2547HJ-XP series Single Row Housing
- *Color: Black

Ordering Information:

A2547WRB-XP - *** - ***
1 2 3

- Part No.
- Material:
(Blank): PBT, UL94V-0
6T: Nylon 6T, UL94V-0
GWT: PBT, UL94V-0, GWT 750 °C
- Finish:
(Blank): Gold-flash
G15: 15µin (0.38µm) MIN. Select Gold (Mating Area)
100µin (2.54µm) MIN. Select Tin
G30: 30µin (0.76µm) MIN. Select Gold (Mating Area)
100µin (2.54µm) MIN. Select Tin
I: Tin over Nickel

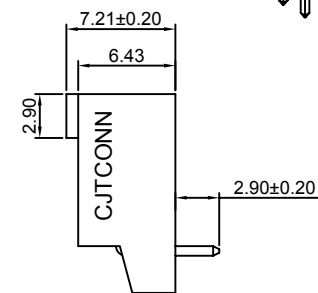
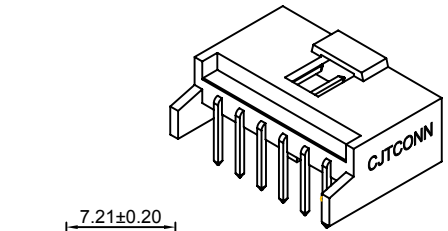
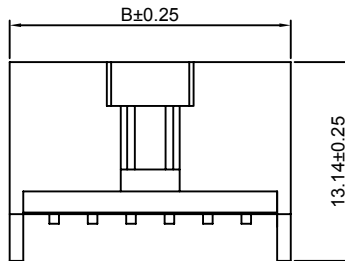
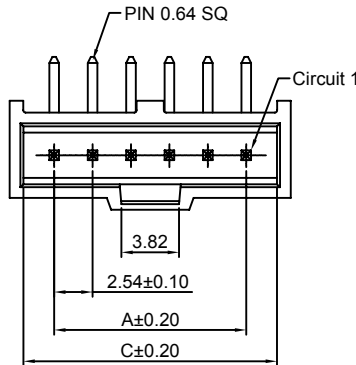

2P~3P

4P~6P

2P~6P

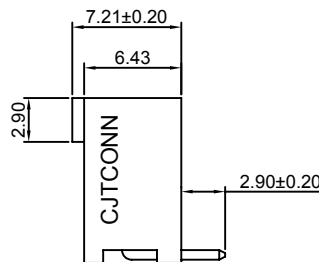
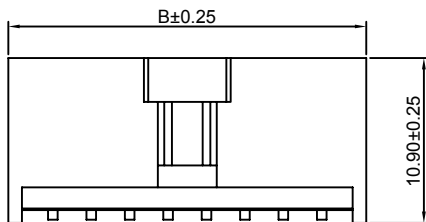
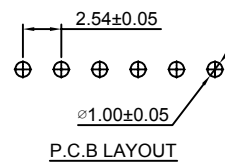

7P~32P

7P~32P

Ordering Information & Dimensions:

PART NO.	Dimensions		
	A	B	C
2P	2.54	8.43	6.60
3P	5.08	10.97	9.14
4P	7.62	13.51	11.68
5P	10.16	16.05	14.22
6P	12.70	18.59	16.76
7P	15.24	21.13	19.30
8P	17.78	23.67	21.84
9P	20.32	26.21	24.38
10P	22.86	28.75	26.92
11P	25.40	31.29	29.46
12P	27.94	33.83	32.00
13P	30.48	36.37	34.54
14P	33.02	38.91	37.08
15P	35.56	41.45	39.62
16P	38.10	43.99	42.16
17P	40.64	46.53	44.70
18P	43.18	49.07	47.24
19P	45.72	51.61	49.78
20P	48.26	54.15	52.32
21P	50.80	56.69	54.86
22P	53.34	59.23	57.40
23P	55.88	61.77	59.94
24P	58.42	64.31	62.48
25P	60.96	66.85	65.02
26P	63.50	69.39	67.56
27P	66.04	71.93	70.10
28P	68.58	74.47	72.64
29P	71.12	77.01	75.18
30P	73.66	79.55	77.72
31P	76.20	82.09	80.26
32P	78.74	84.63	82.80

Unit: mm

A2547WV-2xXP

2.54mm Pitch 180° Box Header

Reference Informations:

- *Material: Pin: Brass/Gold over Nickel
Insulator: PBT, UL94V-0
- *Mates with CJT A2547H, HA, HB, HC, HF, HG, HK, HS-2xXP series Dual row Housing
- *Color: Black



- Ordering Information:
A2547WV-2xXP - ^{***} - ^{***} - ^{***} - ^{***} - ^{***}
- Part No.
 - Material:
(blank): PBT, UL94V-0
6T: Nylon 6T, UL94V-0
GWT: PBT, UL94V-0, GWT 750 °C
 - Finish:
(blank): Gold-flash
G15: 15µin (0.38µm) MIN. Select Gold (Mating Area)
100µin (2.54µm) MIN. Select Tin
G30: 30µin (0.76µm) MIN. Select Gold (Mating Area)
100µin (2.54µm) MIN. Select Tin
T: Tin over Nickel
 - Color:
(blank): Black
GY: Gray
 - Size(L):
(blank): 14.35mm
L: 10.50mm

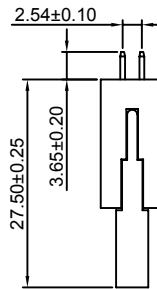
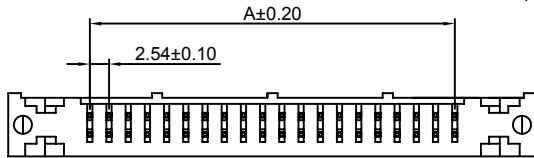

Ordering Information & Dimensions:

PART NO.	Dimensions		
	A	B	C
2x5P	10.16	32.00	18.22
2x6P	12.70	34.54	20.76
2x7P	15.24	37.08	23.30
2x8P	17.78	39.62	25.84
2x9P	20.32	42.16	28.38
2x10P	22.86	44.70	30.92
2x11P	25.40	47.24	33.46
2x12P	27.94	49.78	36.00
2x13P	30.48	52.32	38.54
2x14P	33.02	54.86	41.08
2x15P	35.56	57.40	43.62
2x16P	38.10	59.94	46.16
2x17P	40.64	62.48	48.70
2x18P	43.18	65.02	51.24
2x19P	45.72	67.56	53.78
2x20P	48.26	70.10	56.32
2x21P	50.80	72.64	58.86
2x22P	53.34	75.18	61.40
2x23P	55.88	77.72	63.94
2x24P	58.42	80.26	66.48
2x25P	60.96	82.80	69.02
2x26P	63.50	85.34	71.56
2x27P	66.04	87.88	74.10
2x28P	68.58	90.42	76.64
2x29P	71.12	92.96	79.18
2x30P	73.66	95.50	81.72
2x31P	76.20	98.04	84.26
2x32P	78.74	100.58	86.80

Unit: mm

A2547WR-2xXP

2.54mm Pitch 90° Box Header

Reference Informations:

- *Material: Pin: Brass/Gold over Nickel
Insulator: PBT, UL94V-0
- *Mates with CJT A2547H, HA, HB, HC, HF, HG, HK, HS-2xXP series Dual row Housing
- *Color: Black



- Ordering Information:
A2547WR-2xXP - ^{***} - ^{***} - ^{***} - ^{***} - ^{***}
- Part No.
 - Material:
(blank): PBT, UL94V-0
6T: Nylon 6T, UL94V-0
GWT: PBT, UL94V-0, GWT 750 °C
 - Finish:
(blank): Gold-flash
G15: 15µin (0.38µm) MIN. Select Gold (Mating Area)
100µin (2.54µm) MIN. Select Tin
G30: 30µin (0.76µm) MIN. Select Gold (Mating Area)
100µin (2.54µm) MIN. Select Tin
T: Tin over Nickel
 - Color:
(blank): Black
GY: Gray
 - Size(L):
(blank): 14.35mm
L: 10.50mm

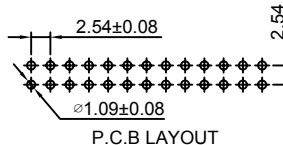
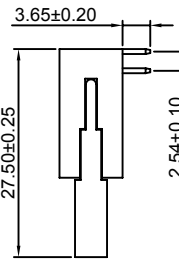
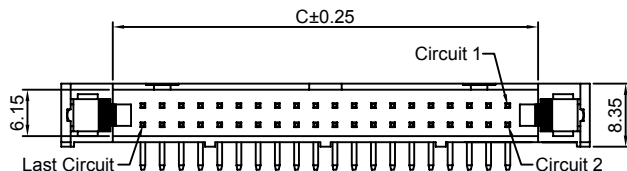
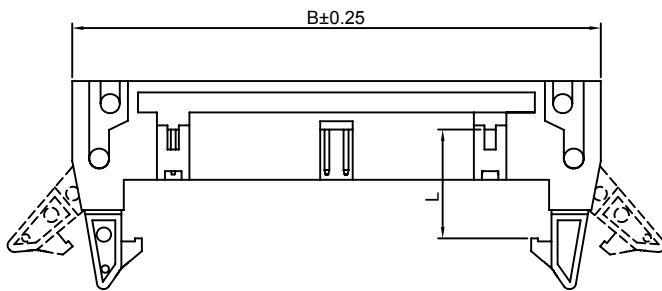
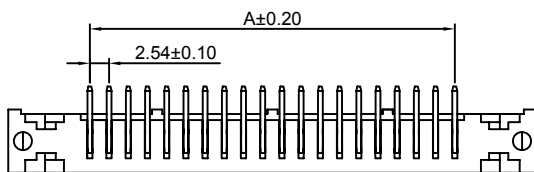

Ordering Information & Dimensions:

PART NO.	Dimensions		
	A	B	C
2x5P	10.16	32.00	18.22
2x6P	12.70	34.54	20.76
2x7P	15.24	37.08	23.30
2x8P	17.78	39.62	25.84
2x9P	20.32	42.16	28.38
2x10P	22.86	44.70	30.92
2x11P	25.40	47.24	33.46
2x12P	27.94	49.78	36.00
2x13P	30.48	52.32	38.54
2x14P	33.02	54.86	41.08
2x15P	35.56	57.40	43.62
2x16P	38.10	59.94	46.16
2x17P	40.64	62.48	48.70
2x18P	43.18	65.02	51.24
2x19P	45.72	67.56	53.78
2x20P	48.26	70.10	56.32
2x21P	50.80	72.64	58.86
2x22P	53.34	75.18	61.40
2x23P	55.88	77.72	63.94
2x24P	58.42	80.26	66.48
2x25P	60.96	82.80	69.02
2x26P	63.50	85.34	71.56
2x27P	66.04	87.88	74.10
2x28P	68.58	90.42	76.64
2x29P	71.12	92.96	79.18
2x30P	73.66	95.50	81.72
2x31P	76.20	98.04	84.26
2x32P	78.74	100.58	86.80

Unit: mm

A2547WVA-2xXP

2.54mm Pitch 180° Box Header

Reference Informations:

- *Material: Pin: Brass/Gold over Nickel
Insulator: PBT, UL94V-0
- *Mates with CJT A2547HD, HSA-2xXP series Dual row Housing
- *Color: Black

Odering Information:
A2547WVA-2xXP - *** - *** - *
1 2 3 4

- Part No.
- Material:
(blank): PBT, UL94V-0
6T: Nylon 6T, UL94V-0
GWT: PBT, UL94V-0, GWT 750 °C
- Finish:
(blank): Gold-flash
G15: 15µm (0.38µm) MIN. Select Gold (Mating Area)
100µm (2.54µm) MIN. Select Tin
G30: 30µm (0.76µm) MIN. Select Gold (Mating Area)
100µm (2.54µm) MIN. Select Tin
T: Tin over Nickel
- Size(L):
(blank): 14.35mm
L: 10.50mm

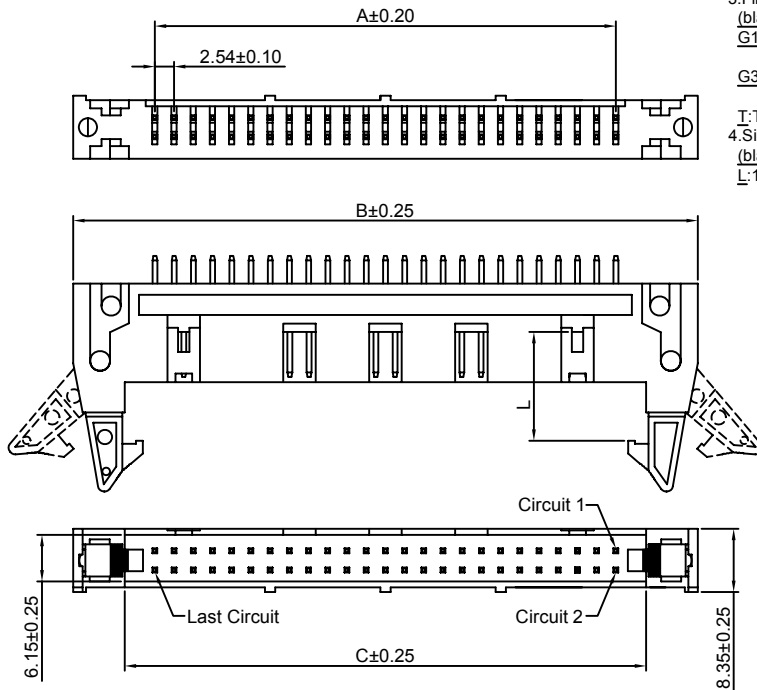

Ordering Information & Dimensions:

PART NO.	Dimensions		
	A	B	C
2x25P	60.96	82.80	69.02
2x30P	73.66	95.50	81.72
2x32P	78.74	100.58	86.80

Unit: mm

A2547WRA-2xXP

2.54mm Pitch 90° Box Header

Reference Informations:

- *Material: Pin: Brass/Gold over Nickel
Insulator: PBT, UL94V-0
- *Mates with CJT A2547HD, HSA-2xXP series Dual row Housing
- *Color: Black

Odering Information:
A2547WRA-2xXP - *** - *** - *
1 2 3 4

- Part No.
- Material:
(Blank): PBT, UL94V-0
6T: Nylon 6T, UL94V-0
GWT: PBT, UL94V-0, GWT 750 °C
- Finish:
(blank): Gold-flash
G15: 15µm (0.38µm) MIN. Select Gold (Mating Area)
100µm (2.54µm) MIN. Select Tin
G30: 30µm (0.76µm) MIN. Select Gold (Mating Area)
100µm (2.54µm) MIN. Select Tin
T: Tin over Nickel
- Size(L):
(blank): 14.35mm
L: 10.50mm

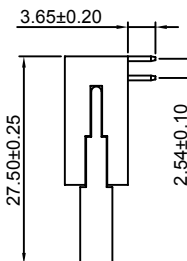
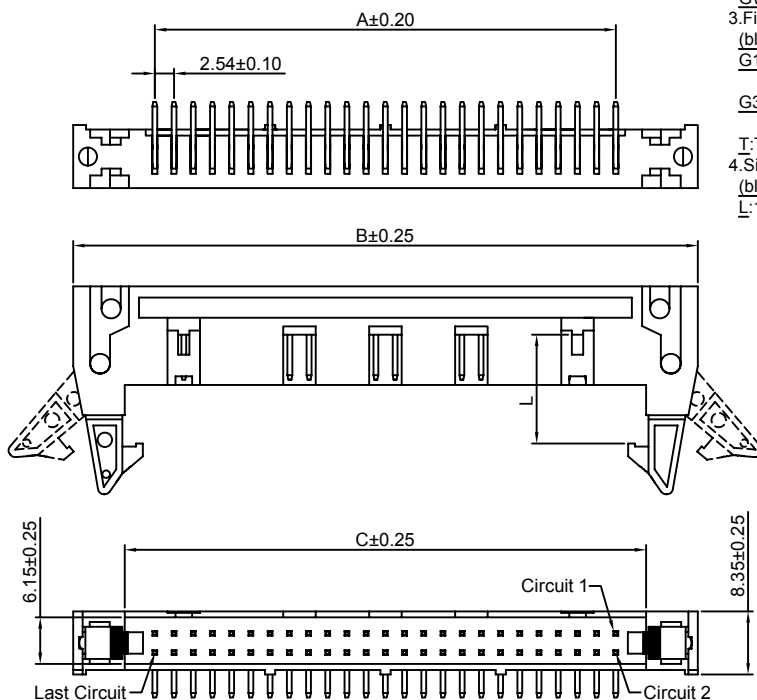
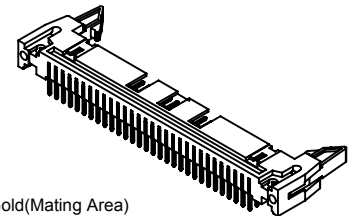

Ordering Information & Dimensions:

PART NO.	Dimensions		
	A	B	C
2x25P	60.96	82.80	69.02
2x30P	73.66	95.50	81.72
2x32P	78.74	100.58	86.80

Unit: mm

A2547WVB-2xXP

2.54mm Pitch 180° Box Header

Reference Informations:

- *Material: Pin: Brass/Gold over Nickel
Insulator: PBT, UL94V-0
- *Mates with CJT A2547HJ-2xXP series Housing
- *Color: Black

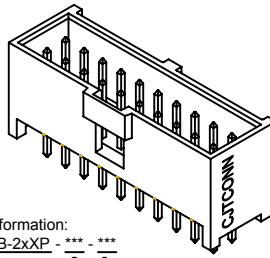
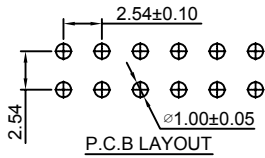

Ordering Information:
A2547WVB-2xXP - *** - ***
1 2 3

1. Part No.
2. Material:
(Blank): PBT, UL94V-0
6T: Nylon 6T, UL94V-0
GWT: PBT, UL94V-0, GWT 750 °C
3. Finish:
(Blank): Gold-flash
G15: 15µin (0.38µm) MIN. Select Gold (Mating Area)
100µin (2.54µm) MIN. Select Tin
G30: 30µin (0.76µm) MIN. Select Gold (Mating Area)
100µin (2.54µm) MIN. Select Tin
T: Tin over Nickel

Ordering Information & Dimensions:

PART NO.	Dimensions		
	A	B	C
2x3P	5.08	9.96	8.12
2x4P	7.62	12.50	10.66
2x5P	10.16	15.04	13.20
2x6P	12.70	17.58	15.74
2x7P	15.24	20.12	18.28
2x8P	17.78	22.66	20.82
2x9P	20.32	25.20	23.36
2x10P	22.86	27.74	25.90
2x11P	25.40	30.28	28.44
2x12P	27.94	32.82	30.98
2x13P	30.48	35.36	33.52
2x14P	33.02	37.90	36.06
2x15P	35.56	40.44	38.60
2x16P	38.10	42.98	41.14
2x17P	40.64	45.52	43.68
2x18P	43.18	48.06	46.22
2x19P	45.72	50.60	48.76
2x20P	48.26	53.14	51.30
2x21P	50.80	55.68	53.84
2x22P	53.34	58.22	56.38
2x23P	55.88	60.76	58.92
2x24P	58.42	63.30	61.46
2x25P	60.96	65.84	64.00
2x26P	63.50	68.38	66.54
2x27P	66.04	70.92	69.08
2x28P	68.58	73.46	71.62
2x29P	71.12	76.00	74.16
2x30P	73.66	78.54	76.70
2x31P	76.20	81.08	79.24
2x32P	78.74	83.62	81.78

Unit: mm

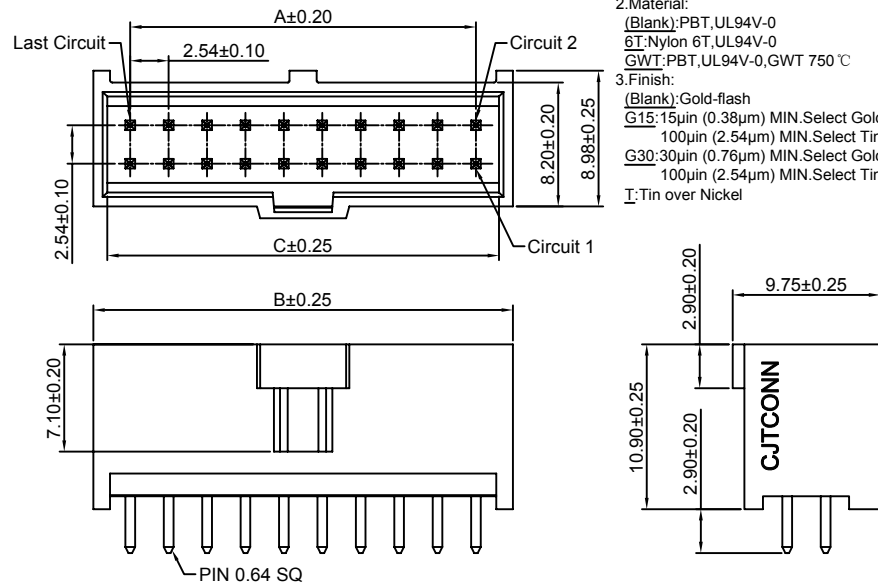

A2547WRB-2xXP

2.54mm Pitch 90° Box Header

Reference Informations:

- *Material: Pin: Brass/Gold over Nickel
Insulator: PBT, UL94V-0
- *Mates with CJT A2547HJ-2xXP series Housing
- *Color: Black

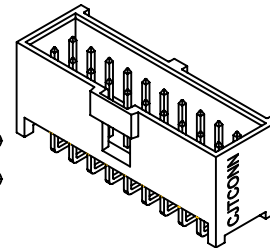
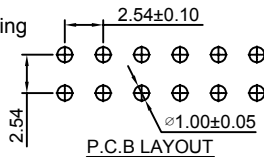

Ordering Information:
A2547WRB-2xXP - *** - ***
1 2 3

1. Part No.
2. Material:
(Blank): PBT, UL94V-0
6T: Nylon 6T, UL94V-0
GWT: PBT, UL94V-0, GWT 750 °C
3. Finish:
(Blank): Gold-flash
G15: 15µin (0.38µm) MIN. Select Gold (Mating Area)
100µin (2.54µm) MIN. Select Tin
G30: 30µin (0.76µm) MIN. Select Gold (Mating Area)
100µin (2.54µm) MIN. Select Tin
T: Tin over Nickel

Ordering Information & Dimensions:

PART NO.	Dimensions		
	A	B	C
2x3P	5.08	9.96	8.12
2x4P	7.62	12.50	10.66
2x5P	10.16	15.04	13.20
2x6P	12.70	17.58	15.74
2x7P	15.24	20.12	18.28
2x8P	17.78	22.66	20.82
2x9P	20.32	25.20	23.36
2x10P	22.86	27.74	25.90
2x11P	25.40	30.28	28.44
2x12P	27.94	32.82	30.98
2x13P	30.48	35.36	33.52
2x14P	33.02	37.90	36.06
2x15P	35.56	40.44	38.60
2x16P	38.10	42.98	41.14
2x17P	40.64	45.52	43.68
2x18P	43.18	48.06	46.22
2x19P	45.72	50.60	48.76
2x20P	48.26	53.14	51.30
2x21P	50.80	55.68	53.84
2x22P	53.34	58.22	56.38
2x23P	55.88	60.76	58.92
2x24P	58.42	63.30	61.46
2x25P	60.96	65.84	64.00
2x26P	63.50	68.38	66.54
2x27P	66.04	70.92	69.08
2x28P	68.58	73.46	71.62
2x29P	71.12	76.00	74.16
2x30P	73.66	78.54	76.70
2x31P	76.20	81.08	79.24
2x32P	78.74	83.62	81.78

Unit: mm

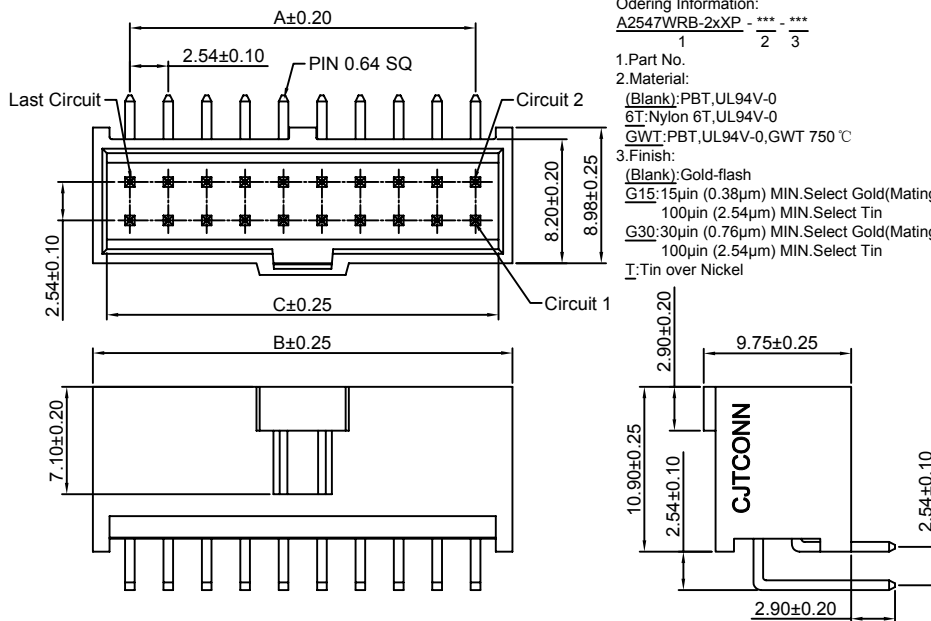

A2547WVB-2xXP-A

2.54mm Pitch 180° Box Header - VERSION WITH VOIDS

Reference Informations:

- *Material: Pin: Brass/Gold over Nickel
Insulator: PBT, UL94V-0
- *Mates with CJT A2547HJ-2xXP series Housing
- *Color: Black

Ordering Information:

A2547WVB-2xXP-A - *** - ***
1 2 3

- Part No.
- Material:
(Blank): PBT, UL94V-0
6T: Nylon 6T, UL94V-0
GWT: PBT, UL94V-0 GWT 750 °C
- Finish:
(Blank): Gold-flash
G15: 15µm (0.38µm) MIN. Select Gold (Mating Area)
100µm (2.54µm) MIN. Select Tin
G30: 30µm (0.76µm) MIN. Select Gold (Mating Area)
100µm (2.54µm) MIN. Select Tin
T: Tin over Nickel

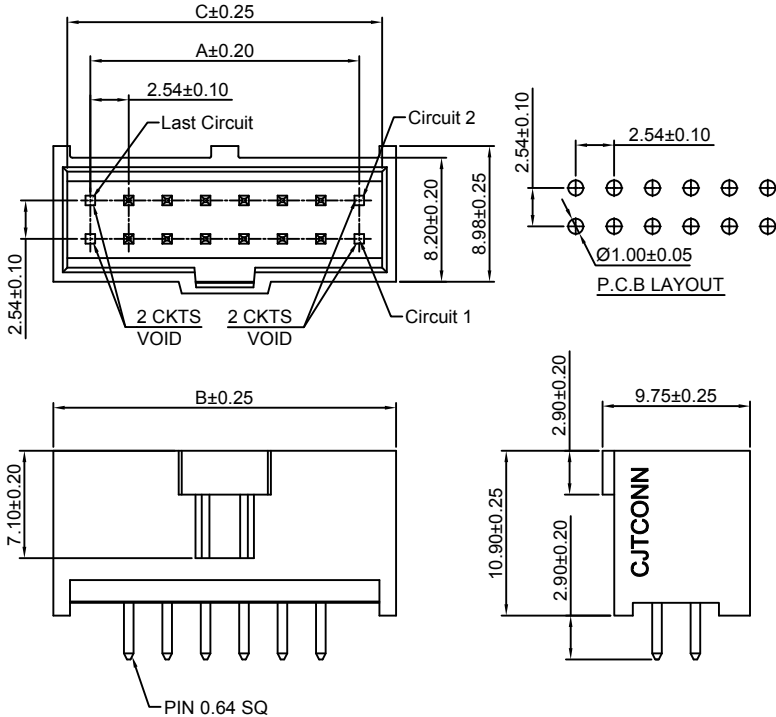
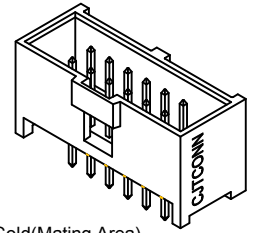

Ordering Information & Dimensions:

PART NO.	Dimensions			PART NO.	Dimensions		
	A	B	C		A	B	C
2x3P	---	9.96	8.12	2x18P	38.10	48.06	46.22
2x4P	2.54	12.50	10.66	2x19P	40.64	50.60	48.76
2x5P	5.08	15.04	13.20	2x20P	43.18	53.14	51.30
2x6P	7.62	17.58	15.74	2x21P	45.72	55.68	53.84
2x7P	10.16	20.12	18.28	2x22P	48.26	58.22	56.38
2x8P	12.70	22.66	20.82	2x23P	50.80	60.76	58.92
2x9P	15.24	25.20	23.36	2x24P	53.34	63.30	61.46
2x10P	17.78	27.74	25.90	2x25P	55.88	65.84	64.00
2x11P	20.32	30.28	28.44	2x26P	58.42	68.38	66.54
2x12P	22.86	32.82	30.98	2x27P	60.96	70.92	69.08
2x13P	25.40	35.36	33.52	2x28P	63.50	73.46	71.62
2x14P	27.94	37.90	36.06	2x29P	66.04	76.00	74.16
2x15P	30.48	40.44	38.60	2x30P	68.58	78.54	76.70
2x16P	33.02	42.98	41.14	2x31P	71.12	81.08	79.24
2x17P	35.56	45.52	43.68	2x32P	73.66	83.62	81.78

Unit: mm

A2547WRB-2xXP-A

2.54mm Pitch 90° Box Header - VERSION WITH VOIDS

Reference Informations:

- *Material: Pin: Brass/Gold over Nickel
Insulator: PBT, UL94V-0
- *Mates with CJT A2547HJ-2xXP series Housing
- *Color: Black

Ordering Information:

A2547WRB-2xXP-A - *** - ***
1 2 3

- Part No.
- Material:
(Blank): PBT, UL94V-0
6T: Nylon 6T, UL94V-0
GWT: PBT, UL94V-0, GWT 750 °C
- Finish:
(Blank): Gold-flash
G15: 15µm (0.38µm) MIN. Select Gold (Mating Area)
100µm (2.54µm) MIN. Select Tin
G30: 30µm (0.76µm) MIN. Select Gold (Mating Area)
100µm (2.54µm) MIN. Select Tin
T: Tin over Nickel

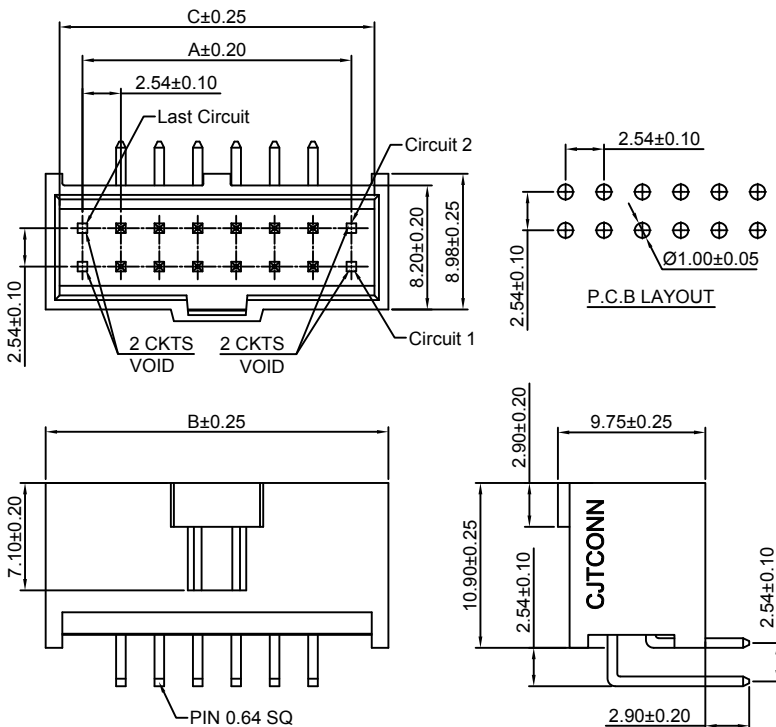
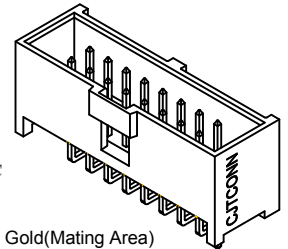

Ordering Information & Dimensions:

PART NO.	Dimensions			PART NO.	Dimensions		
	A	B	C		A	B	C
2x3P	---	9.96	8.12	2x18P	38.10	48.06	46.22
2x4P	2.54	12.50	10.66	2x19P	40.64	50.60	48.76
2x5P	5.08	15.04	13.20	2x20P	43.18	53.14	51.30
2x6P	7.62	17.58	15.74	2x21P	45.72	55.68	53.84
2x7P	10.16	20.12	18.28	2x22P	48.26	58.22	56.38
2x8P	12.70	22.66	20.82	2x23P	50.80	60.76	58.92
2x9P	15.24	25.20	23.36	2x24P	53.34	63.30	61.46
2x10P	17.78	27.74	25.90	2x25P	55.88	65.84	64.00
2x11P	20.32	30.28	28.44	2x26P	58.42	68.38	66.54
2x12P	22.86	32.82	30.98	2x27P	60.96	70.92	69.08
2x13P	25.40	35.36	33.52	2x28P	63.50	73.46	71.62
2x14P	27.94	37.90	36.06	2x29P	66.04	76.00	74.16
2x15P	30.48	40.44	38.60	2x30P	68.58	78.54	76.70
2x16P	33.02	42.98	41.14	2x31P	71.12	81.08	79.24
2x17P	35.56	45.52	43.68	2x32P	73.66	83.62	81.78

Unit: mm

A2547WVB-S-2xXP

2.54mm Pitch 180° Box Header - SMT TYPE

Reference Informations:

- *Material: Pin: Brass/Gold over Nickel
Insulator: Nylon 6T, UL94V-0
- *Mates with CJT A2547HJ-2xXP series Dual row Housing
- *Color: Black

Ordering Information:
A2547WVB-S-2xXP - *** - ***
1 2 3

- Part No.
- Material:
(Blank): Nylon 6T, UL94V-0
GWT: Nylon 6T, UL94V-0, GWT 750 °C
- Finish:
(Blank): Gold-flash
G15: 15µin (0.38µm) MIN. Select Gold (Mating Area)
100µin (2.54µm) MIN. Select Tin
G30: 30µin (0.76µm) MIN. Select Gold (Mating Area)
100µin (2.54µm) MIN. Select Tin
T: Tin over Nickel

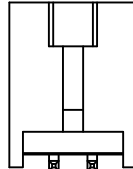
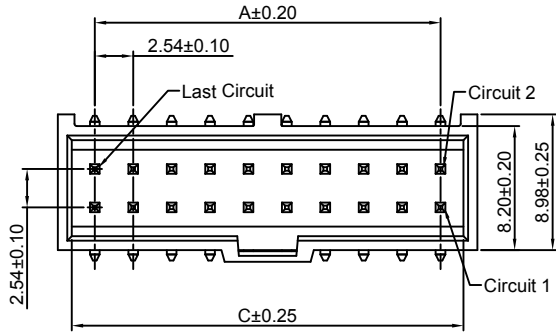
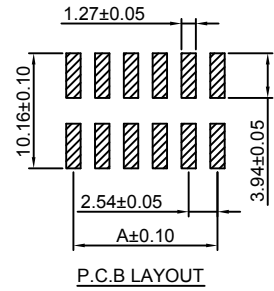

2x2P

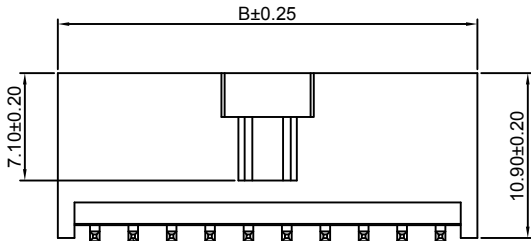

2x3P~2x34P

Ordering Information & Dimensions:

PART NO.	Dimensions			PART NO.	Dimensions		
	A	B	C		A	B	C
2x2P	2.54	7.42	5.58	2x19P	45.72	50.60	48.76
2x3P	5.08	9.96	8.12	2x20P	48.26	53.14	51.30
2x4P	7.62	12.50	10.66	2x21P	50.80	55.68	53.84
2x5P	10.16	15.04	13.20	2x22P	53.34	58.22	56.38
2x6P	12.70	17.58	15.74	2x23P	55.88	60.76	58.92
2x7P	15.24	20.12	18.28	2x24P	58.42	63.30	61.46
2x8P	17.78	22.66	20.82	2x25P	60.96	65.84	64.00
2x9P	20.32	25.20	23.36	2x26P	63.50	68.38	66.54
2x10P	22.86	27.74	25.90	2x27P	66.04	70.92	69.08
2x11P	25.40	30.28	28.44	2x28P	68.58	73.46	71.62
2x12P	27.94	32.82	30.98	2x29P	71.12	76.00	74.16
2x13P	30.48	35.36	33.52	2x30P	73.66	78.54	76.70
2x14P	33.02	37.90	36.06	2x31P	76.20	81.08	79.24
2x15P	35.56	40.44	38.60	2x32P	78.74	83.62	81.78
2x16P	38.10	42.98	41.14	2x33P	81.28	86.16	84.32
2x17P	40.64	45.52	43.68	2x34P	83.82	88.70	86.86
2x18P	43.18	48.06	46.22				

Unit: mm

A2547WVB-S-2xXP-A

2.54mm Pitch 180° Box Header - SMT TYPE VERSION WITH VOIDS

Reference Informations:

- *Material: Pin: Brass/Gold over Nickel
Insulator: Nylon 6T, UL94V-0
- *Mates with CJT A2547HJ-2xXP series Housing
- *Color: Black

Ordering Information:
A2547WVB-S-2xXP-A - *** - ***
1 2 3

- Part No.
- Material:
(Blank): Nylon 6T, UL94V-0
GWT: Nylon 6T, UL94V-0, GWT 750 °C
- Finish:
(Blank): Gold-flash
G15: 15µin (0.38µm) MIN. Select Gold (Mating Area)
100µin (2.54µm) MIN. Select Tin
G30: 30µin (0.76µm) MIN. Select Gold (Mating Area)
100µin (2.54µm) MIN. Select Tin
T: Tin over Nickel

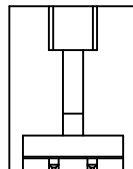
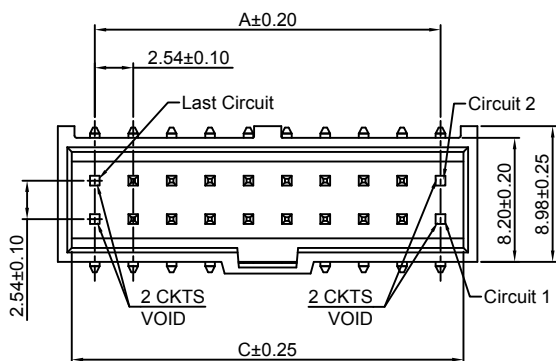
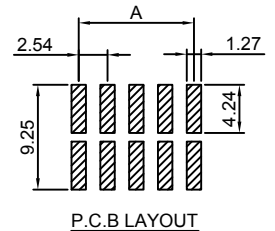

2x2P

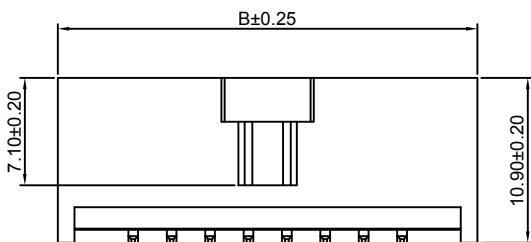

2x3P~2x34P

Ordering Information & Dimensions:

PART NO.	Dimensions			PART NO.	Dimensions		
	A	B	C		A	B	C
2x3P	---	9.96	8.12	2x18P	38.10	48.06	46.22
2x4P	2.54	12.50	10.66	2x19P	40.64	50.60	48.76
2x5P	5.08	15.04	13.20	2x20P	43.18	53.14	51.30
2x6P	7.62	17.58	15.74	2x21P	45.72	55.68	53.84
2x7P	10.16	20.12	18.28	2x22P	48.26	58.22	56.38
2x8P	12.70	22.66	20.82	2x23P	50.80	60.76	58.92
2x9P	15.24	25.20	23.36	2x24P	53.34	63.30	61.46
2x10P	17.78	27.74	25.90	2x25P	55.88	65.84	64.00
2x11P	20.32	30.28	28.44	2x26P	58.42	68.38	66.54
2x12P	22.86	32.82	30.98	2x27P	60.96	70.92	69.08
2x13P	25.40	35.36	33.52	2x28P	63.50	73.46	71.62
2x14P	27.94	37.90	36.06	2x29P	66.04	76.00	74.16
2x15P	30.48	40.44	38.60	2x30P	68.58	78.54	76.70
2x16P	33.02	42.98	41.14	2x31P	71.12	81.08	79.24
2x17P	35.56	45.52	43.68	2x32P	73.66	83.62	81.78

Unit: mm

A2547WVC-2xXP

2.54mm Pitch 180° Box Header

Reference Informations:

- *Material: Pin: Brass/Gold over Nickel
Insulator: PBT, UL94V-0
- *Mates with CJT A2547 series Dual row Housing
- *Color: Black

Ordering Information:
A2547WVC-2xXP - *** - ***
1 2 3

- Part No.
- Material:
(Blank): PBT, UL94V-0
6T: Nylon 6T, UL94V-0
GWT: PBT, UL94V-0, GWT 750°C
- Finish:
(Blank): Gold-flash
G15: 15µin (0.38µm) MIN. Select Gold (Mating Area)
100µin (2.54µm) MIN. Select Tin
G30: 30µin (0.76µm) MIN. Select Gold (Mating Area)
100µin (2.54µm) MIN. Select Tin
T: Tin over Nickel

Ordering Information & Dimensions:

PART NO.	Dimensions	
	A	B
2x5P	10.16	31.90
2x6P	12.70	34.44
2x7P	15.24	36.98
2x8P	17.78	39.52
2x9P	20.32	42.06
2x10P	22.86	44.60
2x11P	25.40	47.14
2x12P	27.94	49.68
2x13P	30.48	52.22
2x14P	33.02	54.76
2x15P	35.56	57.30
2x16P	38.10	59.84
2x17P	40.64	62.38
2x18P	43.18	64.92
2x19P	45.72	67.46
2x20P	48.26	70.00
2x21P	50.80	72.54
2x22P	53.34	75.08
2x23P	55.88	77.62
2x24P	58.42	80.16
2x25P	60.96	82.70
2x26P	63.50	85.24
2x27P	66.04	87.78
2x28P	68.58	90.32
2x29P	71.12	92.86
2x30P	73.66	95.40
2x31P	76.20	97.94
2x32P	78.74	100.48

Unit: mm

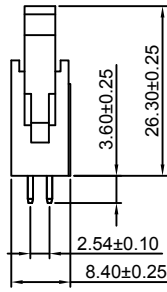
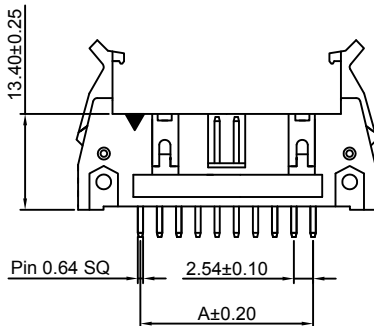
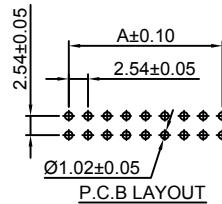
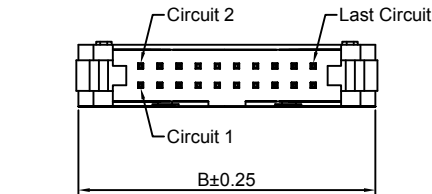

A2547WRC-2xXP

2.54mm Pitch 90° Box Header

Reference Informations:

- *Material: Pin: Brass/Gold over Nickel
Insulator: PBT, UL94V-0
- *Mates with CJT A2547 series Dual row Housing
- *Color: Black

Ordering Information:
A2547WRC-2xXP - *** - ***
1 2 3

- Part No.
- Material:
(Blank): PBT, UL94V-0
6T: Nylon 6T, UL94V-0
GWT: PBT, UL94V-0, GWT 750°C
- Finish:
(Blank): Gold-flash
G15: 15µin (0.38µm) MIN. Select Gold (Mating Area)
100µin (2.54µm) MIN. Select Tin
G30: 30µin (0.76µm) MIN. Select Gold (Mating Area)
100µin (2.54µm) MIN. Select Tin
T: Tin over Nickel

Ordering Information & Dimensions:

PART NO.	Dimensions	
	A	B
2x5P	10.16	31.90
2x6P	12.70	34.44
2x7P	15.24	36.98
2x8P	17.78	39.52
2x9P	20.32	42.06
2x10P	22.86	44.60
2x11P	25.40	47.14
2x12P	27.94	49.68
2x13P	30.48	52.22
2x14P	33.02	54.76
2x15P	35.56	57.30
2x16P	38.10	59.84
2x17P	40.64	62.38
2x18P	43.18	64.92
2x19P	45.72	67.46
2x20P	48.26	70.00
2x21P	50.80	72.54
2x22P	53.34	75.08
2x23P	55.88	77.62
2x24P	58.42	80.16
2x25P	60.96	82.70
2x26P	63.50	85.24
2x27P	66.04	87.78
2x28P	68.58	90.32
2x29P	71.12	92.86
2x30P	73.66	95.40
2x31P	76.20	97.94
2x32P	78.74	100.48

Unit: mm

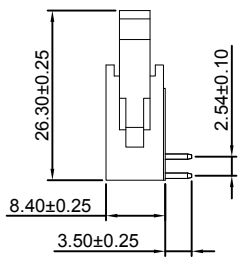
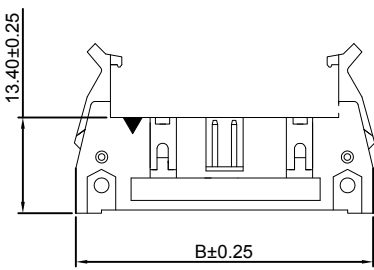
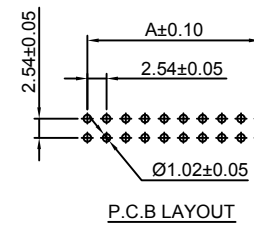
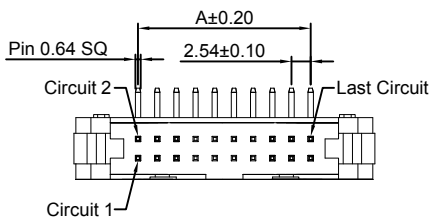

A2547WV-N-2xXP

2.54mm Pitch 180° Dual Row Box Header

Reference Informations:

- *Material: Pin: Brass/Gold over Nickel
Insulator: PBT, UL94V-0
- *Mates with CJT A2541H-N-2xXP, A2541H-N-2xXP-2, A2547HN-2xXP series Dual row Housing
- *Color: Black

Ordering Information:
A2547WV-N-2xXP - *** - ***
1 2 3

1. Part No.
2. Material:
(Blank): PBT, UL94V-0
6T: Nylon 6T, UL94V-0
GWT: PBT, UL94V-0, GWT 750 °C
3. Finish:
(Blank): Gold-flash
G15: 15µm (0.38µm) MIN. Select Gold (Mating Area)
100µm (2.54µm) MIN. Select Tin
G30: 30µm (0.76µm) MIN. Select Gold (Mating Area)
100µm (2.54µm) MIN. Select Tin
T: Tin over Nickel

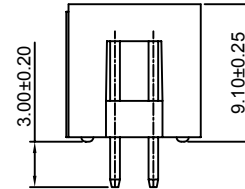
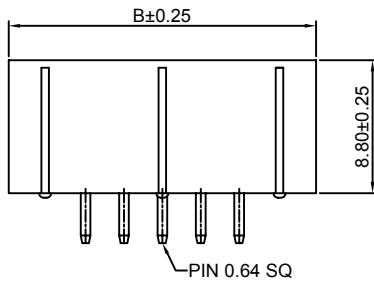
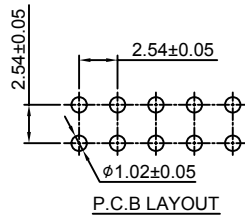
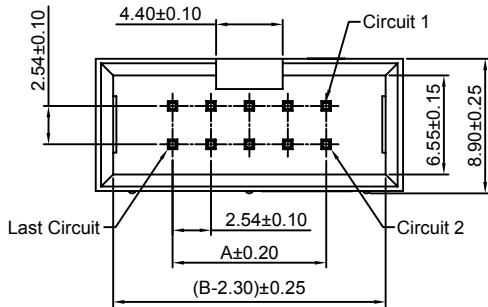
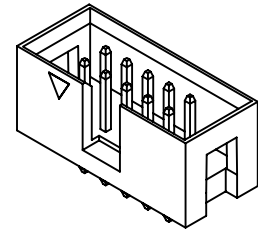

Ordering Information & Dimensions:

PART NO.	Dimensions		PART NO.	Dimensions	
	A	B		A	B
2x2P	2.54	12.70	2x22P	53.34	63.50
2x3P	5.08	15.24	2x23P	55.88	66.04
2x4P	7.62	17.78	2x24P	58.42	68.58
2x5P	10.16	20.32	2x25P	60.96	71.12
2x6P	12.70	22.86	2x26P	63.50	73.66
2x7P	15.24	25.40	2x27P	66.04	76.20
2x8P	17.78	27.94	2x28P	68.58	78.74
2x9P	20.32	30.48	2x29P	71.12	81.28
2x10P	22.86	33.02	2x30P	73.66	83.82
2x11P	25.40	35.56	2x31P	76.20	86.36
2x12P	27.94	38.10	2x32P	78.74	88.90
2x13P	30.48	40.64	2x33P	81.28	91.44
2x14P	33.02	43.18	2x34P	83.82	93.98
2x15P	35.56	45.72	2x35P	86.36	96.52
2x16P	38.10	48.26	2x36P	88.90	99.06
2x17P	40.64	50.80	2x37P	91.44	101.60
2x18P	43.18	53.34	2x38P	93.98	104.14
2x19P	45.72	55.88	2x39P	96.52	106.68
2x20P	48.26	58.42	2x40P	99.06	109.22
2x21P	50.80	60.96			

Unit: mm

A2547WR-N-2xXP

2.54mm Pitch 90° Dual Row Box Header

Reference Informations:

- *Material: Pin: Brass/Gold over Nickel
Insulator: PBT, UL94V-0
- *Mates with CJT A2541H-N-2xXP, A2541H-N-2xXP-2, A2547HN-2xXP series Dual row Housing
- *Color: Black

Ordering Information:
A2547WR-N-2xXP - *** - ***
1 2 3

1. Part No.
2. Material:
(Blank): PBT, UL94V-0
6T: Nylon 6T, UL94V-0
GWT :PBT, UL94V-0 GWT 750 °C
3. Finish:
(Blank): Gold-flash
G15: 15µm (0.38µm) MIN. Select Gold (Mating Area)
100µm (2.54µm) MIN. Select Tin
G30: 30µm (0.76µm) MIN. Select Gold (Mating Area)
100µm (2.54µm) MIN. Select Tin
T: Tin over Nickel

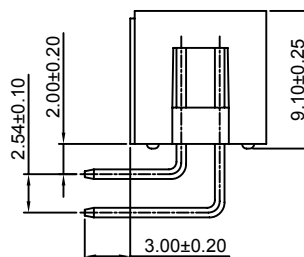
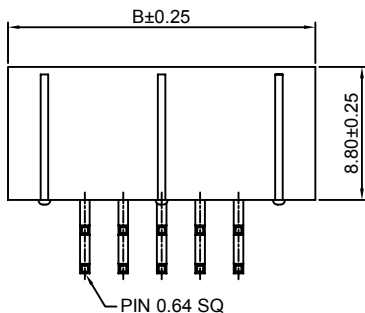
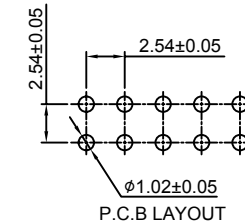
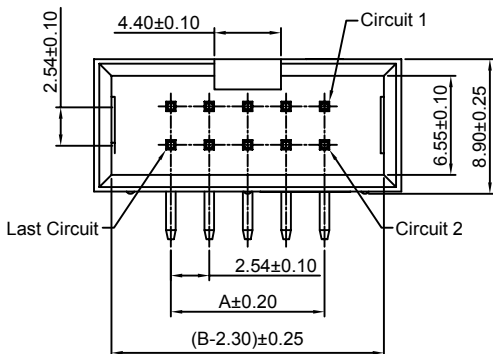
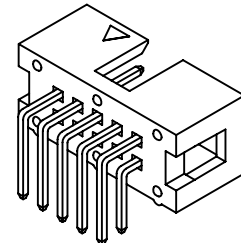

Ordering Information & Dimensions:

PART NO.	Dimensions		PART NO.	Dimensions	
	A	B		A	B
2x2P	2.54	12.70	2x22P	53.34	63.50
2x3P	5.08	15.24	2x23P	55.88	66.04
2x4P	7.62	17.78	2x24P	58.42	68.58
2x5P	10.16	20.32	2x25P	60.96	71.12
2x6P	12.70	22.86	2x26P	63.50	73.66
2x7P	15.24	25.40	2x27P	66.04	76.20
2x8P	17.78	27.94	2x28P	68.58	78.74
2x9P	20.32	30.48	2x29P	71.12	81.28
2x10P	22.86	33.02	2x30P	73.66	83.82
2x11P	25.40	35.56	2x31P	76.20	86.36
2x12P	27.94	38.10	2x32P	78.74	88.90
2x13P	30.48	40.64	2x33P	81.28	91.44
2x14P	33.02	43.18	2x34P	83.82	93.98
2x15P	35.56	45.72	2x35P	86.36	96.52
2x16P	38.10	48.26	2x36P	88.90	99.06
2x17P	40.64	50.80	2x37P	91.44	101.60
2x18P	43.18	53.34	2x38P	93.98	104.14
2x19P	45.72	55.88	2x39P	96.52	106.68
2x20P	48.26	58.42	2x40P	99.06	109.22
2x21P	50.80	60.96			

Unit: mm

A2547WV-S-2xXP

2.54mm Pitch 180° Box Header - SMT TYPE

Reference Informations:

- *Material: Pin: Brass/Gold over Nickel
Insulator: Nylon 6T, UL94V-0
- *Mates with CJT A2547H, HA, HB, HC, HF, HG, HS-2xXP series Dual row Housing
- *Color: Black

Ordering Information:
A2547WV-S-2xXP - ^{***}/₁ - ^{***}/₂ - ^{***}/₃ - ^{***}/₄

1. Part No.
2. Material:
(Blank): Nylon 6T, UL94V-0
GWT: Nylon 6T, UL94V-0, GWT 750 °C
3. Finish:
(Blank): Gold-flash
G15: 15µm (0.38µm) MIN. Select Gold (Mating Area)
100µm (2.54µm) MIN. Select Tin
G30: 30µm (0.76µm) MIN. Select Gold (Mating Area)
100µm (2.54µm) MIN. Select Tin
T: Tin over Nickel
4. Size (L):
(blank): 14.35mm
L: 10.50mm

Ordering Information & Dimensions:

PART NO.	Dimensions		
	A	B	C
2x3P	5.08	26.92	13.14
2x4P	7.62	29.46	15.68
2x5P	10.16	32.00	18.22
2x6P	12.70	34.54	20.76
2x7P	15.24	37.08	23.30
2x8P	17.78	39.62	25.84
2x9P	20.32	42.16	28.38
2x10P	22.86	44.70	30.92
2x11P	25.40	47.24	33.46
2x12P	27.94	49.78	36.00
2x13P	30.48	52.32	38.54
2x14P	33.02	54.86	41.08
2x15P	35.56	57.40	43.62
2x16P	38.10	59.94	46.16
2x17P	40.64	62.48	48.70
2x18P	43.18	65.02	51.24
2x19P	45.72	67.56	53.78
2x20P	48.26	70.10	56.32
2x21P	50.80	72.64	58.86
2x22P	53.34	75.18	61.40
2x23P	55.88	77.72	63.94
2x24P	58.42	80.26	66.48
2x25P	60.96	82.80	69.02
2x26P	63.50	85.34	71.56
2x27P	66.04	87.88	74.10
2x28P	68.58	90.42	76.64
2x29P	71.12	92.96	79.18
2x30P	73.66	95.50	81.72
2x31P	76.20	98.04	84.26
2x32P	78.74	100.58	86.80

Unit: mm

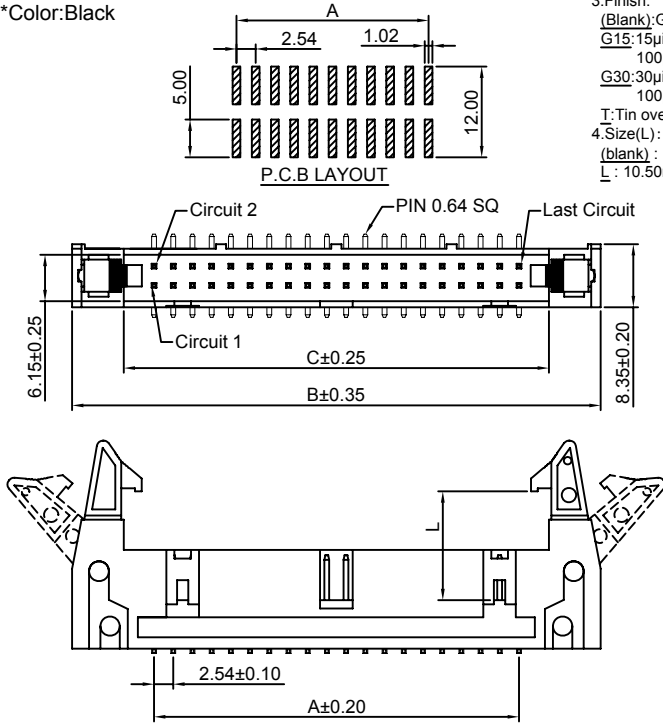

A2547WV-N-S-2xXP

2.54mm Pitch 180° Box Header - SMT TYPE

Reference Informations:

- *Material: Pin: Brass/Gold over Nickel
Insulator: Nylon 6T, UL94V-0
- *Mates with CJT A2541H-2xXP, A2541H-N-2xXP, A2547HN-2xXP series Dual row Housing
- *Color: Black

Ordering Information:
A2547WV-N-S-2xXP - ^{***}/₁ - ^{***}/₂ - ^{***}/₃

1. Part No.
2. Material:
(Blank): Nylon 6T, UL94V-0
GWT: Nylon 6T, UL94V-0, GWT 750 °C
3. Finish:
(Blank): Gold-flash
G15: 15µm (0.38µm) MIN. Select Gold (Mating Area)
100µm (2.54µm) MIN. Select Tin
G30: 30µm (0.76µm) MIN. Select Gold (Mating Area)
100µm (2.54µm) MIN. Select Tin
T: Tin over Nickel

Ordering Information & Dimensions:

PART NO.	Dimensions		PART NO.	Dimensions	
	A	B		A	B
2x2P	2.54	12.70	2x22P	53.34	63.50
2x3P	5.08	15.24	2x23P	55.88	66.04
2x4P	7.62	17.78	2x24P	58.42	68.58
2x5P	10.16	20.32	2x25P	60.96	71.12
2x6P	12.70	22.86	2x26P	63.50	73.66
2x7P	15.24	25.40	2x27P	66.04	76.20
2x8P	17.78	27.94	2x28P	68.58	78.74
2x9P	20.32	30.48	2x29P	71.12	81.28
2x10P	22.86	33.02	2x30P	73.66	83.82
2x11P	25.40	35.56	2x31P	76.20	86.36
2x12P	27.94	38.10	2x32P	78.74	88.90
2x13P	30.48	40.64	2x33P	81.28	91.44
2x14P	33.02	43.18	2x34P	83.82	93.98
2x15P	35.56	45.72	2x35P	86.36	96.52
2x16P	38.10	48.26	2x36P	88.90	99.06
2x17P	40.64	50.80	2x37P	91.44	101.60
2x18P	43.18	53.34	2x38P	93.98	104.14
2x19P	45.72	55.88	2x39P	96.52	106.68
2x20P	48.26	58.42	2x40P	99.06	109.22
2x21P	50.80	60.96			

Unit: mm

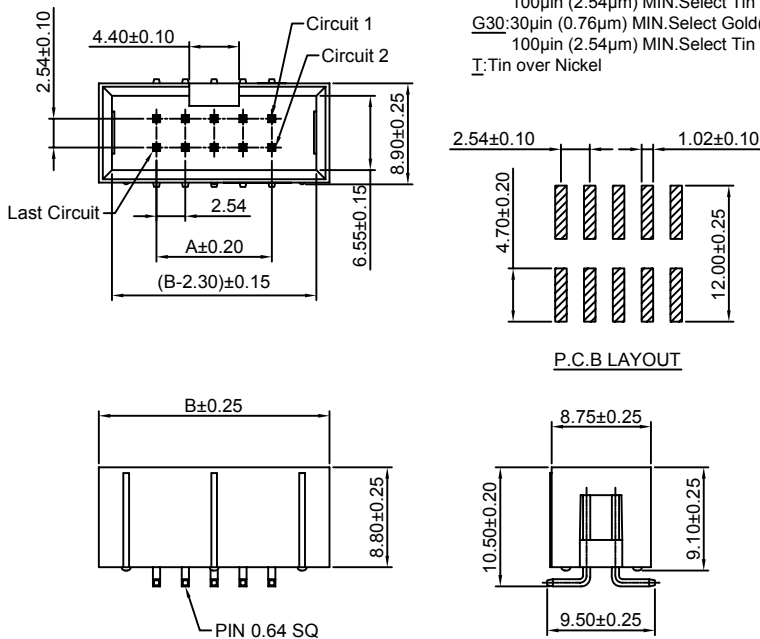

A2547WVA-N-2xXP

2.54mm Pitch 180° Box Header

Reference Informations:

- *Material: Pin: Brass/Gold over Nickel
Insulator: PBT, UL94V-0
- *Mates with CJT A2547 series Dual row Housing
- *Color: Black

Ordering Information:
A2547WVA-N-2xXP - ¹ - ² - ³ - ⁴ - ⁵

- Part No.
- Material:
(Blank): PBT, UL94V-0
6T: Nylon 6T, UL94V-0
GWT: PBT, UL94V-0, GWT 750°C
- Color:
(blank): Black
GY: Gray
BL: Blue
- Finish:
(Blank): Gold-flash
G15: 15µin (0.38µm) MIN. Select Gold (Mating Area)
100µin (2.54µm) MIN. Select Tin
G30: 30µin (0.76µm) MIN. Select Gold (Mating Area)
100µin (2.54µm) MIN. Select Tin
T: Tin over Nickel
- Size(D):
(blank): 2.90mm
D45: 4.50mm

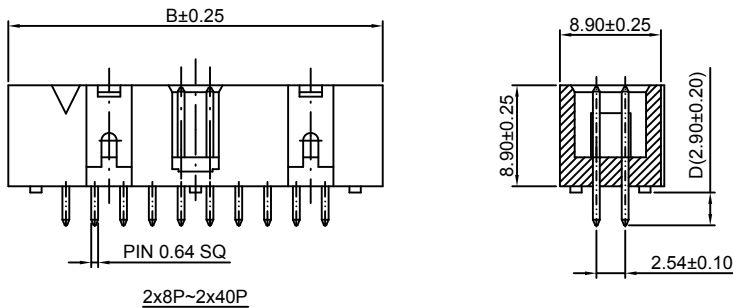
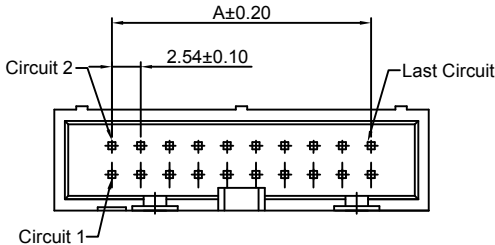
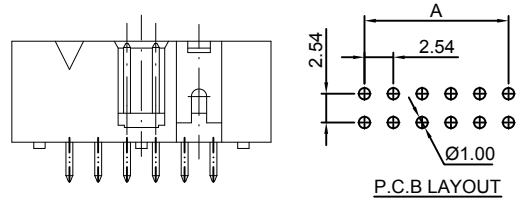

Ordering Information & Dimensions:

PART NO.	Dimensions		PART NO.	Dimensions	
	A	B		A	B
2x6P	12.70	22.86	2x24P	58.42	68.58
2x7P	15.24	25.40	2x25P	60.96	71.12
2x8P	17.78	27.94	2x26P	63.50	73.66
2x9P	20.32	30.48	2x27P	66.04	76.20
2x10P	22.86	33.02	2x28P	68.58	78.74
2x11P	25.40	35.56	2x29P	71.12	81.28
2x12P	27.94	38.10	2x30P	73.66	83.82
2x13P	30.48	40.64	2x31P	76.20	86.36
2x14P	33.02	43.18	2x32P	78.74	88.90
2x15P	35.56	45.72	2x33P	81.28	91.44
2x16P	38.10	48.26	2x34P	83.82	93.98
2x17P	40.64	50.80	2x35P	86.36	96.52
2x18P	43.18	53.34	2x36P	88.90	99.06
2x19P	45.72	55.88	2x37P	91.44	101.60
2x20P	48.26	58.42	2x38P	93.98	104.14
2x21P	50.80	60.96	2x39P	96.52	106.68
2x22P	53.34	63.50	2x40P	99.06	109.22
2x23P	55.88	66.04			

Unit: mm

A2547WRA-N-2xXP

2.54mm Pitch 90° Box Header

Reference Informations:

- *Material: Pin: Brass/Gold over Nickel
Insulator: PBT, UL94V-0
- *Mates with CJT A2547 series Dual row Housing
- *Color: Black

Ordering Information:
A2547WRA-N-2xXP - ¹ - ² - ³ - ⁴ - ⁵

- Part No.
- Material:
(Blank): PBT, UL94V-0
6T: Nylon 6T, UL94V-0
GWT: PBT, UL94V-0, GWT 750°C
- Color:
(blank): Black
GY: Gray
BL: Blue
- Finish:
(Blank): Gold-flash
G15: 15µin (0.38µm) MIN. Select Gold (Mating Area)
100µin (2.54µm) MIN. Select Tin
G30: 30µin (0.76µm) MIN. Select Gold (Mating Area)
100µin (2.54µm) MIN. Select Tin
T: Tin over Nickel
- Size(D):
(blank): 4.50mm
D29: 2.90mm

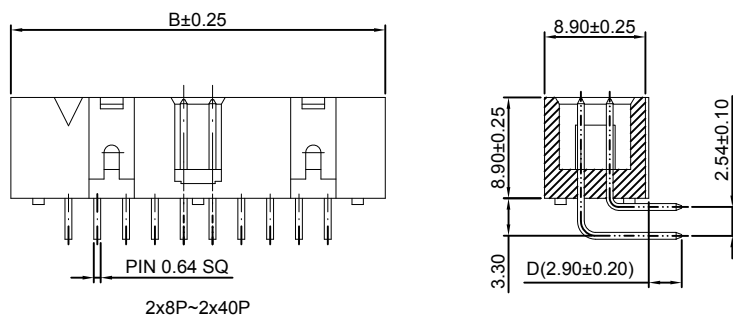
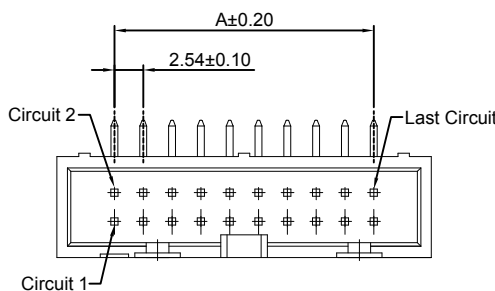
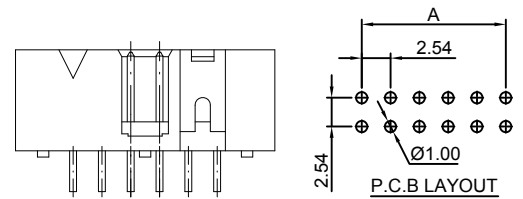

Ordering Information & Dimensions:

PART NO.	Dimensions		PART NO.	Dimensions	
	A	B		A	B
2x6P	12.70	22.86	2x24P	58.42	68.58
2x7P	15.24	25.40	2x25P	60.96	71.12
2x8P	17.78	27.94	2x26P	63.50	73.66
2x9P	20.32	30.48	2x27P	66.04	76.20
2x10P	22.86	33.02	2x28P	68.58	78.74
2x11P	25.40	35.56	2x29P	71.12	81.28
2x12P	27.94	38.10	2x30P	73.66	83.82
2x13P	30.48	40.64	2x31P	76.20	86.36
2x14P	33.02	43.18	2x32P	78.74	88.90
2x15P	35.56	45.72	2x33P	81.28	91.44
2x16P	38.10	48.26	2x34P	83.82	93.98
2x17P	40.64	50.80	2x35P	86.36	96.52
2x18P	43.18	53.34	2x36P	88.90	99.06
2x19P	45.72	55.88	2x37P	91.44	101.60
2x20P	48.26	58.42	2x38P	93.98	104.14
2x21P	50.80	60.96	2x39P	96.52	106.68
2x22P	53.34	63.50	2x40P	99.06	109.22
2x23P	55.88	66.04			

Unit: mm

A2547FC-N-2xXP-Y

2.54mm Pitch IDC Socket

Reference Informations:

- *Material:Pin:Brass/Tin over Nickel
Insulator:PBT,UL94V-0
- *Mates with CJT A2547 series Dual row Wafer
- *Color:Black

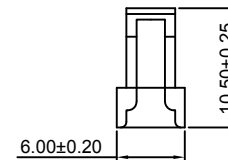
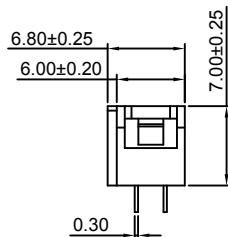
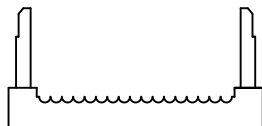
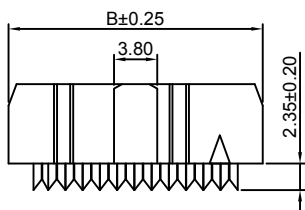
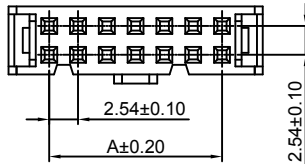

Ordering Information:

A2547FC-N-2xXP-Y - *** - ** - ***
1 2 3 4

- Part No.
- Material:
(Blank):PBT,UL94V-0
6T:Nylon 6T,UL94V-0
GWT:PBT,UL94V-0,GWT 750°C
- Color:
(blank):Black
GY:Gray
- Finish:
(Blank):Tin over Nickel
G:Gold-flash
G15:15µm (0.38µm) MIN.Select Gold(Mating Area)
100µm (2.54µm) MIN.Select Tin
G30:30µm (0.76µm) MIN.Select Gold(Mating Area)
100µm (2.54µm) MIN.Select Tin

Ordering Information & Dimensions:

PART NO.	Dimensions		PART NO.	Dimensions	
	A	B		A	B
2x3P	5.08	12.42	2x16P	38.10	45.44
2x4P	10.16	14.96	2x17P	40.64	47.98
2x5P	15.24	17.50	2x18P	43.18	50.52
2x6P	20.32	20.04	2x19P	45.72	53.06
2x7P	25.40	22.58	2x20P	48.26	55.60
2x8P	30.48	25.12	2x21P	50.80	58.14
2x9P	35.56	27.66	2x22P	53.34	60.68
2x10P	40.64	30.20	2x23P	55.88	63.22
2x11P	45.72	32.74	2x24P	58.42	65.76
2x12P	50.80	35.28	2x25P	60.96	68.30
2x13P	55.88	37.82	2x30P	73.66	81.00
2x14P	60.96	40.36	2x32P	78.74	86.08
2x15P	66.04	42.90			

Unit: mm

A2547FCWV-2xXP

2.54mm Pitch 180° IDC Wafer

Reference Informations:

- *Material:Pin:Brass/Tin over Nickel
Insulator:PBT,UL94V-0
- *Color:Black

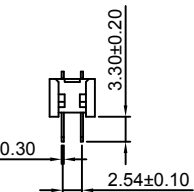
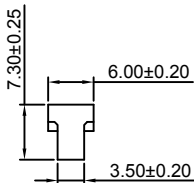
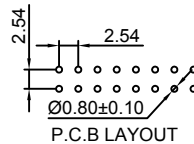
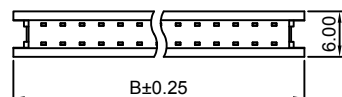
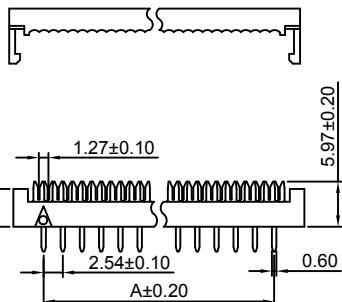
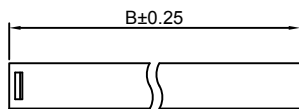

Ordering Information:

A2547FCWV-2xXP - *** - ** - ***
1 2 3 4

- Part No.
- Material:
(Blank):PBT,UL94V-0
6T:Nylon 6T,UL94V-0
GWT:PBT,UL94V-0,GWT 750°C
- Color:
(blank):Black
GY:Gray
- Finish:
(Blank):Tin over Nickel
G:Gold-flash
G15:15µm (0.38µm) MIN.Select Gold(Mating Area)
100µm (2.54µm) MIN.Select Tin
G30:30µm (0.76µm) MIN.Select Gold(Mating Area)
100µm (2.54µm) MIN.Select Tin

Ordering Information & Dimensions:

PART NO.	Dimensions		PART NO.	Dimensions	
	A	B		A	B
2x3P	5.08	13.08	2x16P	38.10	46.10
2x4P	10.16	15.62	2x17P	40.64	48.64
2x5P	15.24	18.16	2x18P	43.18	51.18
2x6P	20.32	20.70	2x19P	45.72	53.72
2x7P	25.40	23.24	2x20P	48.26	56.26
2x8P	30.48	25.78	2x21P	50.80	58.80
2x9P	35.56	28.32	2x22P	53.34	61.34
2x10P	40.64	30.86	2x23P	55.88	63.88
2x11P	45.72	33.40	2x24P	58.42	66.42
2x12P	50.80	35.94	2x25P	60.96	68.96
2x13P	55.88	38.48	2x30P	73.66	81.66
2x14P	60.96	41.02	2x32P	78.74	86.74
2x15P	66.04	43.56			

Unit: mm

A2547HI-2xXP

2.54mm Pitch 180° Box Header

Reference Informations:

- *Material: Pin: Brass/Gold over Nickel
Insulator: PBT, UL94V-0
- *Mates with CJT A2547H-2xXP series Dual row Housing
- *Color: Gray

Ordering Information:

A2547HI-2xXP - *** - ***
1 2 3

- 1. Part No.
- 2. Material:
(Blank): PBT, UL94V-0
6T: Nylon 6T, UL94V-0
GWT: PBT, UL94V-0, GWT 750°C
- 3. Finish:
(Blank): Gold-flash
G15: 15µm (0.38µm) MIN. Select Gold (Mating Area)
100µm (2.54µm) MIN. Select Tin
G30: 30µm (0.76µm) MIN. Select Gold (Mating Area)
100µm (2.54µm) MIN. Select Tin
T: Tin over Nickel

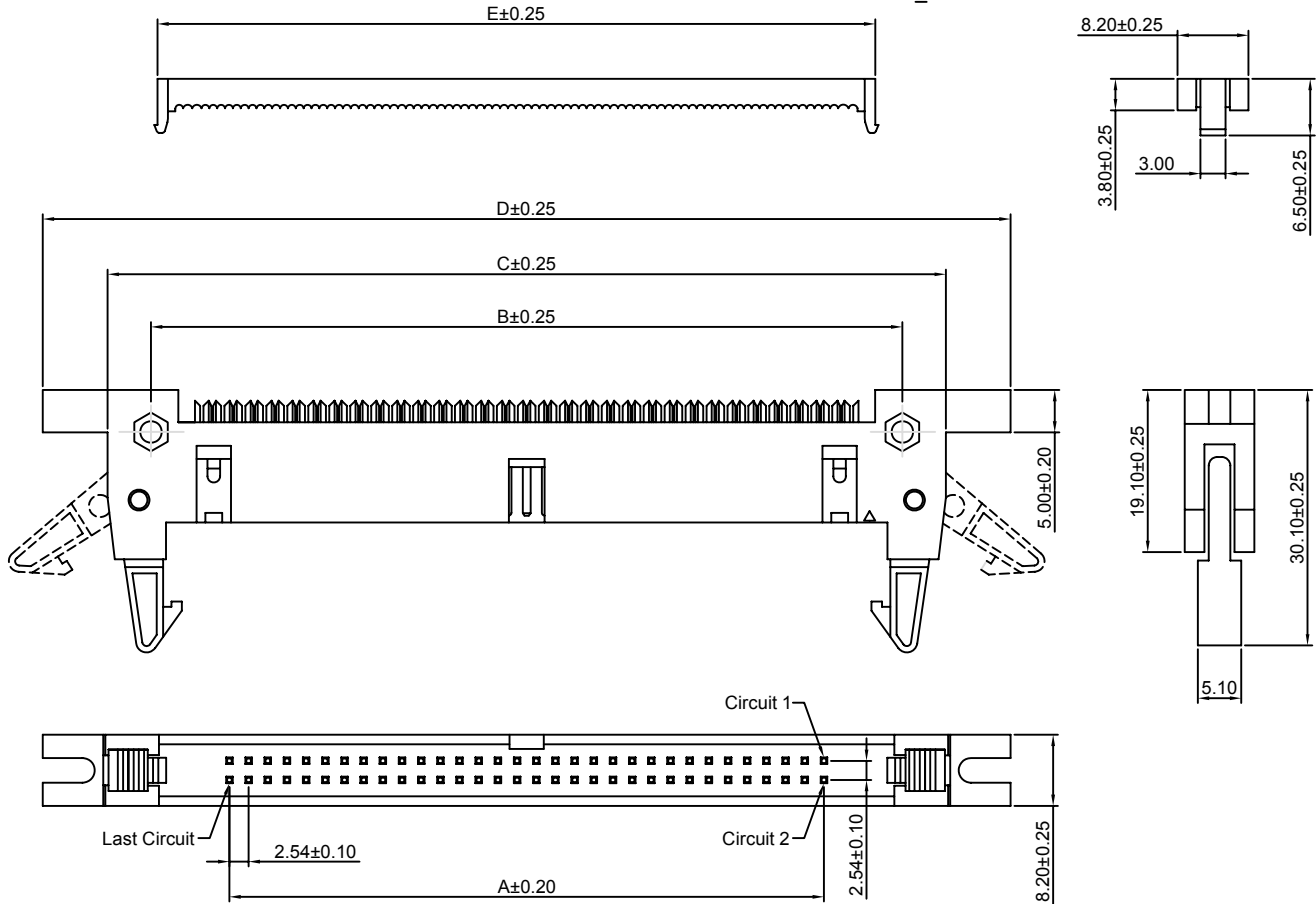

Ordering Information & Dimensions:

PART NO.	Dimensions					PART NO.	Dimensions				
	A	B	C	D	E		A	B	C	D	E
2x5P	10.16	24.39	31.92	47.32	17.27	2x19P	45.72	59.95	67.18	82.88	52.83
2x6P	12.70	26.93	34.46	49.86	19.81	2x20P	48.26	62.49	69.72	85.42	55.37
2x7P	15.24	29.47	37.00	52.40	22.35	2x21P	50.80	65.03	72.26	87.96	57.91
2x8P	17.78	32.01	39.54	54.94	24.89	2x22P	53.34	67.57	74.80	90.50	60.45
2x9P	20.32	34.55	42.08	57.48	27.43	2x23P	55.88	70.11	77.34	93.04	62.99
2x10P	22.86	37.09	44.62	60.02	29.97	2x24P	58.42	72.65	79.88	95.58	65.53
2x11P	25.40	39.63	47.16	62.56	32.51	2x25P	60.96	75.19	82.42	98.12	68.07
2x12P	27.94	42.17	49.70	65.10	35.05	2x26P	63.50	77.73	84.96	100.66	70.61
2x13P	30.48	44.71	52.24	67.64	37.59	2x27P	66.04	80.27	87.50	103.20	73.15
2x14P	33.02	47.25	54.78	70.18	40.13	2x28P	68.58	82.81	90.04	105.74	75.69
2x15P	35.56	49.79	57.32	72.72	42.67	2x29P	71.12	85.35	92.58	108.28	78.23
2x16P	38.10	52.33	59.86	75.26	45.21	2x30P	73.66	87.89	95.12	110.82	80.77
2x17P	40.64	54.87	62.40	77.80	47.75	2x31P	76.20	90.43	97.66	113.36	83.31
2x18P	43.18	57.41	64.94	80.34	50.29	2x32P	78.74	92.97	100.20	115.90	85.85

Unit: mm

A2547HIA-2xXP

2.54mm Pitch 180° Box Header

Reference Informations:

- *Material: Pin: Brass/Gold over Nickel
Insulator: PBT, UL94V-0
- *Mates with CJT A2547H-2xXP series Dual row Housing
- *Color: Gray

Ordering Information:

A2547HIA-2xXP - *** - ***
1 2 3

1. Part No.
2. Material:
(Blank): PBT, UL94V-0
6T: Nylon 6T, UL94V-0
GWT: PBT, UL94V-0, GWT 750°C
3. Finish:
(Blank): Gold-flash
G15: 15µm (0.38µm) MIN. Select Gold (Mating Area)
100µm (2.54µm) MIN. Select Tin
G30: 30µm (0.76µm) MIN. Select Gold (Mating Area)
100µm (2.54µm) MIN. Select Tin
T: Tin over Nickel

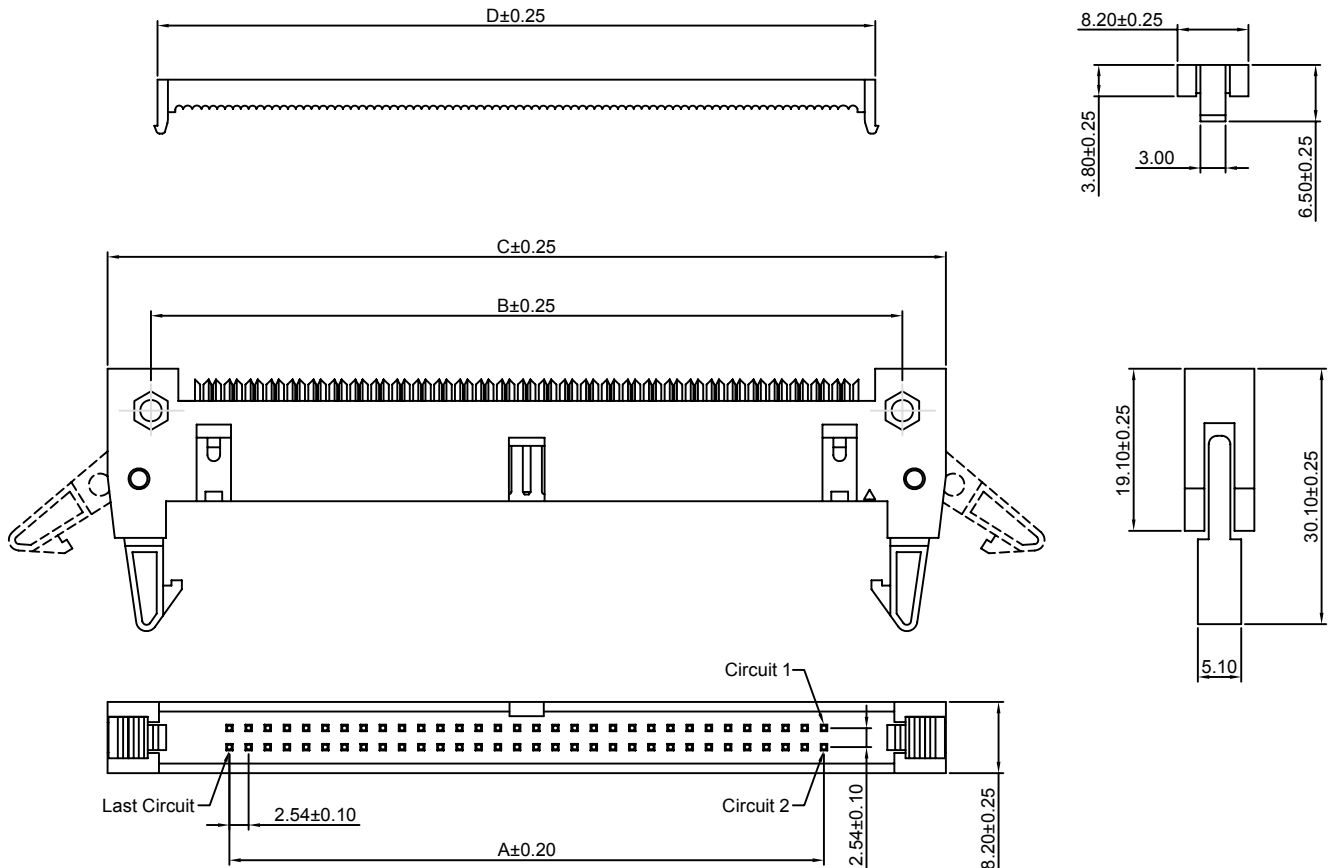

Ordering Information & Dimensions:

PART NO.	Dimensions				PART NO.	Dimensions			
	A	B	C	D		A	B	C	D
2x5P	10.16	24.39	31.92	17.27	2x19P	45.72	59.95	67.18	52.83
2x6P	12.70	26.93	34.46	19.81	2x20P	48.26	62.49	69.72	55.37
2x7P	15.24	29.47	37.00	22.35	2x21P	50.80	65.03	72.26	57.91
2x8P	17.78	32.01	39.54	24.89	2x22P	53.34	67.57	74.80	60.45
2x9P	20.32	34.55	42.08	27.43	2x23P	55.88	70.11	77.34	62.99
2x10P	22.86	37.09	44.62	29.97	2x24P	58.42	72.65	79.88	65.53
2x11P	25.40	39.63	47.16	32.51	2x25P	60.96	75.19	82.42	68.07
2x12P	27.94	42.17	49.70	35.05	2x26P	63.50	77.73	84.96	70.61
2x13P	30.48	44.71	52.24	37.59	2x27P	66.04	80.27	87.50	73.15
2x14P	33.02	47.25	54.78	40.13	2x28P	68.58	82.81	90.04	75.69
2x15P	35.56	49.79	57.32	42.67	2x29P	71.12	85.35	92.58	78.23
2x16P	38.10	52.33	59.86	45.21	2x30P	73.66	87.89	95.12	80.77
2x17P	40.64	54.87	62.40	47.75	2x31P	76.20	90.43	97.66	83.31
2x18P	43.18	57.41	64.94	50.29	2x32P	78.74	92.97	100.20	85.85

Unit: mm

X-ON Electronics

Largest Supplier of Electrical and Electronic Components

Click to view similar products for [Terminals](#) category:

Click to view products by [Changjiang](#) manufacturer:

Other Similar products are found below :

[HT-13-10](#) [71M-250-32-NB](#) [01-2065-1-0216](#) [00581P0075](#) [M10-10RX](#) [M10BCK](#) [60205-1](#) [604200-1](#) [60598-1-CUT-TAPE](#) [60617-1-C](#) [60873-1](#) [M14-516R/SK](#) [M14-6RSX](#) [M18-10FLX](#) [M18-8FBX](#) [M18-8R/LX](#) [M18BCK](#) [61314-6-C](#) [61-S](#) [61-SN-A](#) [62149-1](#) [62-NBM-A](#) [63-S](#) [640179-1](#) [640917-2-CUT-TAPE](#) [6501550002](#) [66107-2-C](#) [66107-4-C](#) [696683-1](#) [696834-1](#) [696861-1](#) [696931-1](#) [696999-1](#) [M8-516RK](#) [M86700006](#) [MA250DMFMX-A](#) [701-2007](#) [701-2307](#) [701-7761-03](#) [70F-110-32-PB](#) [718-N-A](#) [71M-187-20-NBL](#) [71M-250-32-NBL](#) [72F-187-20-NBL](#) [72M-250-32-NBL](#) [7310](#) [73F-250-32](#) [73F-250-32-NBL](#) [73F-250-32-NL](#) [F14-10C](#)