

Dual N-Channel Enhancement Mode MOSFET TDM3484

**DESCRIPTION**

The TDM3484 uses advanced trench technology to provide excellent RDS(ON) and low gate charge. This device is suitable for use as a load switch or in PWM applications.

**GENERAL FEATURES**

- RDS(ON) < 18.5mΩ @ VGS=4.5V  
RDS(ON) < 15mΩ @ VGS=10V
- High Power and current handling capability
- Lead free product is available
- SOP-8 Package

**Application**

- PWM applications
- Load switch
- Power management

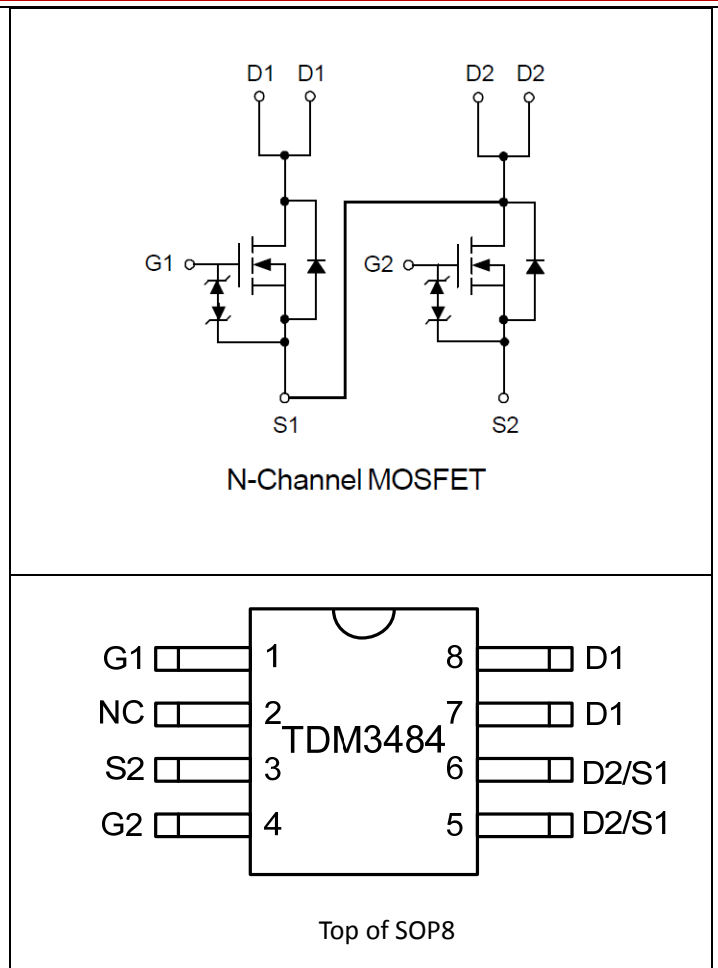

ABSOLUTE MAXIMUM RATINGS(TA=25°C unless otherwise noted)

Parameter	Symbol	Limit	Unit
Drain-Source Voltage	V <sub>DS</sub>	40	V
Gate-Source Voltage	V <sub>GS</sub>	±20	V
Drain Current @ Continuous	I <sub>D</sub> (T <sub>A</sub> =25°C)	12	A
	I <sub>D</sub> (T <sub>A</sub> =70°C)	9.6	A
Drain Current @ Current-Pulsed (Note 1)	I <sub>DM</sub> (T <sub>C</sub> =25°C)	60	A
Drain Current @ Continuous	I <sub>D</sub> (T <sub>C</sub> =25°C)	43	A
	I <sub>D</sub> (T <sub>C</sub> =100°C)	28	A
Maximum Power Dissipation (T <sub>A</sub> =25°C)	P <sub>D</sub>	2	W
Maximum Operating Junction Temperature	T <sub>J</sub>	150	°C
Storage Temperature Range	T <sub>STG</sub>	-55 To 150	°C

THERMAL CHARACTERISTICS

Thermal Resistance,Junction-to-Ambient (t<10s)	RθJA	50	°C/W
--	------	----	------

**ELECTRICAL CHARACTERISTICS** ( $T_A=25^{\circ}\text{C}$  unless otherwise noted)

Parameter	Symbol	Condition	Min	Typ	Max	Unit
<b>OFF CHARACTERISTICS</b>						
Drain-Source Breakdown Voltage	$BV_{DSS}$	$V_{GS}=0V, I_D=250\mu A$	40	-	-	V
Zero Gate Voltage Drain Current	$I_{DSS}$	$V_{DS}=32V, V_{GS}=0V$	-	-	1	$\mu A$
Gate-Body Leakage Current	$I_{GSS}$	$V_{GS}=\pm 20V, V_{DS}=0V$	-	-	$\pm 10$	$\mu A$
<b>ON CHARACTERISTICS</b> (Note 2)						
Gate Threshold Voltage	$V_{GS(th)}$	$V_{DS}=V_{GS}, I_D=250\mu A$	1.4	1.7	2.5	V
Drain-Source On-State Resistance	$R_{DS(on)}$	$V_{GS}=4.5V, I_D=8A$	-	14.6	18.5	$m\Omega$
		$V_{GS}=10V, I_D=15A$	-	11	15	$m\Omega$
<b>DYNAMIC CHARACTERISTICS</b> (Note 4)						
Input Capacitance	$C_{iss}$	$V_{DS}=20V, V_{GS}=0V, F=1.0MHz$	-	700	-	PF
Output Capacitance	$C_{oss}$		-	191	-	PF
Reverse Transfer Capacitance	$C_{rss}$		-	30	-	PF
<b>SWITCHING CHARACTERISTICS</b> (Note 3)						
Turn-on Delay Time	$t_{d(on)}$	$V_{DS}=20V, R_L=20\Omega, V_{GEN}=10V, R_G=6\Omega, I_D=1A$	-	10	-	nS
Turn-on Rise Time	$t_r$		-	6.6	-	nS
Turn-Off Delay Time	$t_{d(off)}$		-	18	-	nS
Turn-Off Fall Time	$t_f$		-	12	-	nS
Total Gate Charge	$Q_g$	$V_{DS}=20V, I_D=15A, V_{GS}=4.5V$	-	5.1	-	nC
Gate-Source Charge	$Q_{gs}$		-	2.9	-	nC
Gate-Drain Charge	$Q_{gd}$		-	1.1	-	nC
Body Diode Reverse Recovery Time	$T_{rr}$	$I_F=5A, di/dt=100A/\mu s$	-	18.8	-	nS
Body Diode Reverse Recovery Charge	$Q_{rr}$		-	4.5	-	nC
<b>DRAIN-SOURCE DIODE CHARACTERISTICS</b>						
Diode Forward Voltage (Note 2)	$V_{SD}$	$V_{GS}=0V, I_S=20A$	-	0.8	1.1	V

**NOTES:**

1. Pulse width limited by max. junction temperature.
2. Pulse Test: Pulse Width  $\leq 300\mu s$ , Duty Cycle  $\leq 2\%$ .
3. Guaranteed by design, not subject to production testing

Typical Operating Characteristics

Power Dissipation

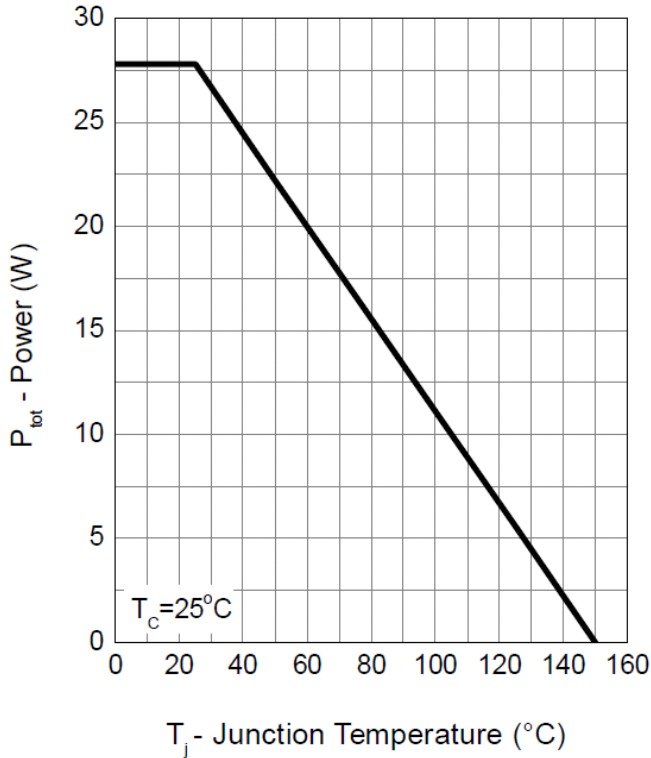

Drain Current

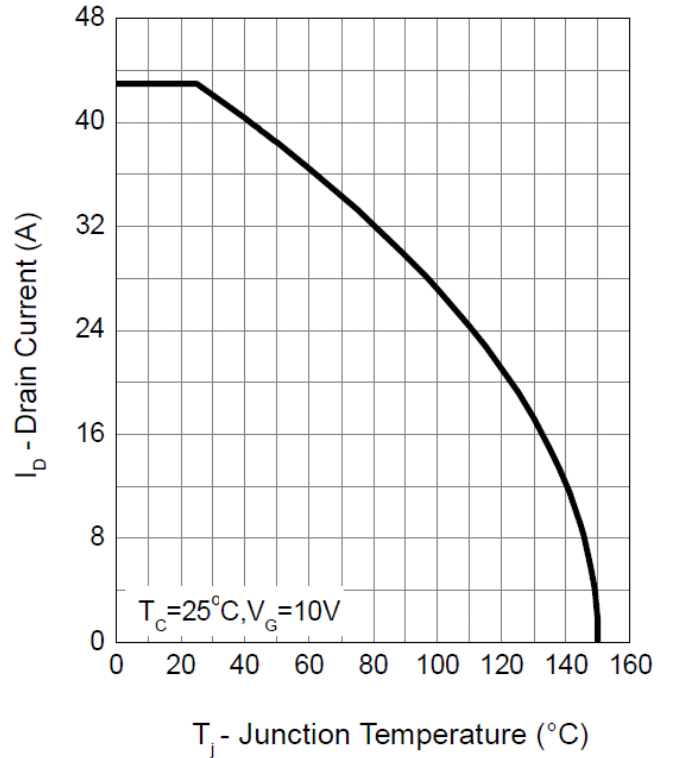

Safe Operation Area

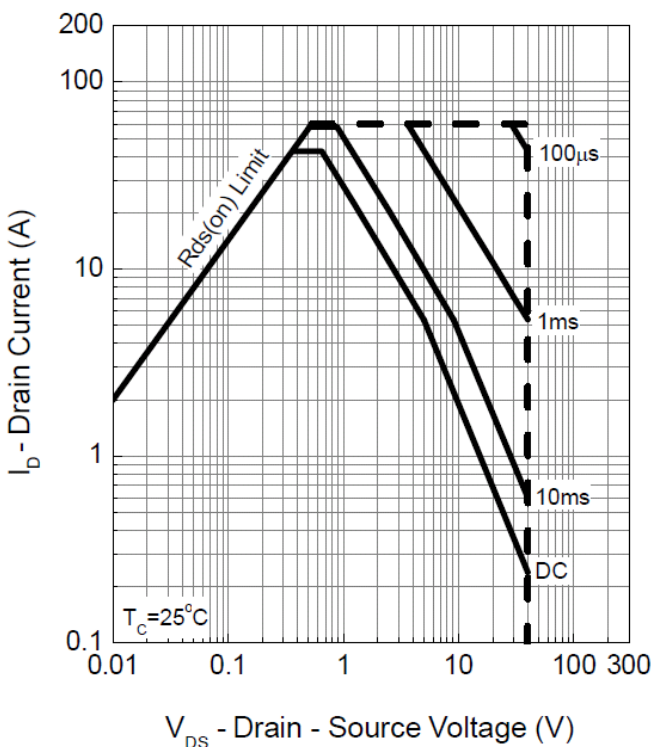

Thermal Transient Impedance

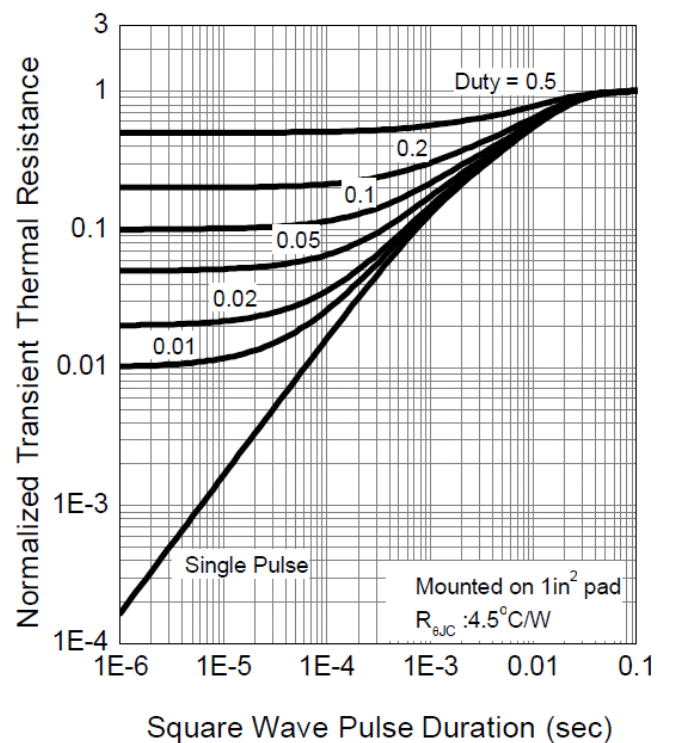

Typical Operating Characteristics(Cont.)

Safe Operation Area

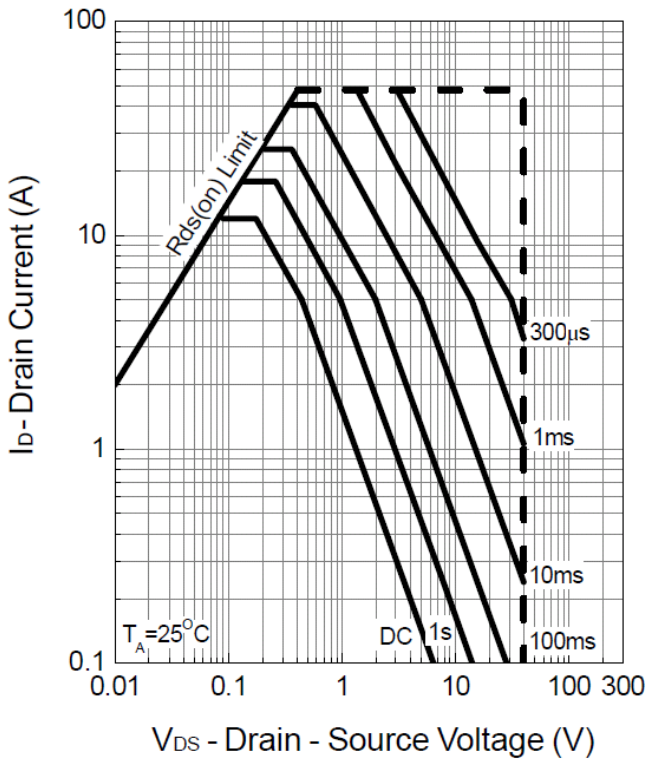

Thermal Transient Impedance

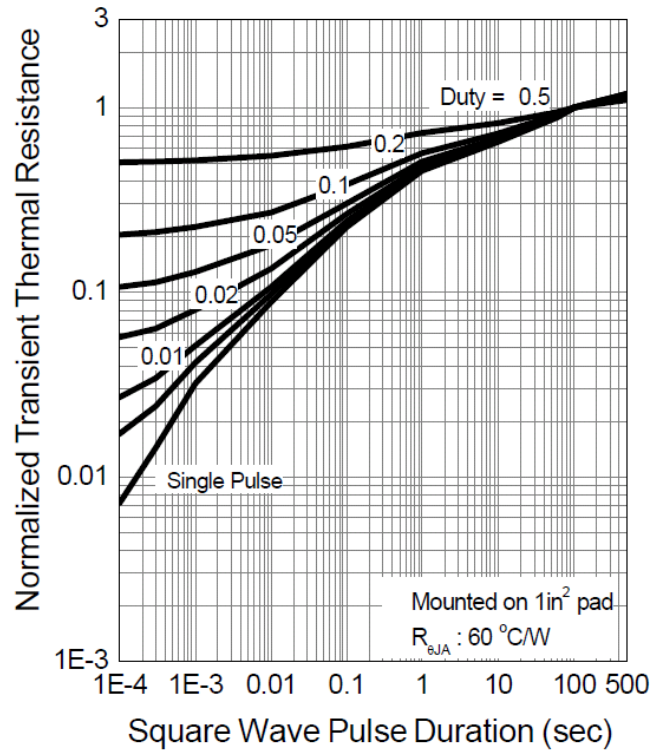

Output Characteristics

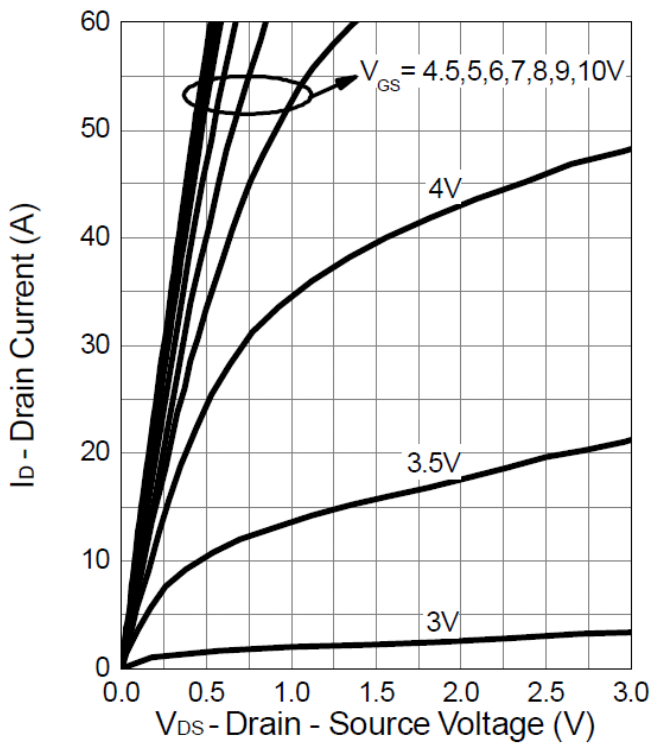

Drain-Source On Resistance

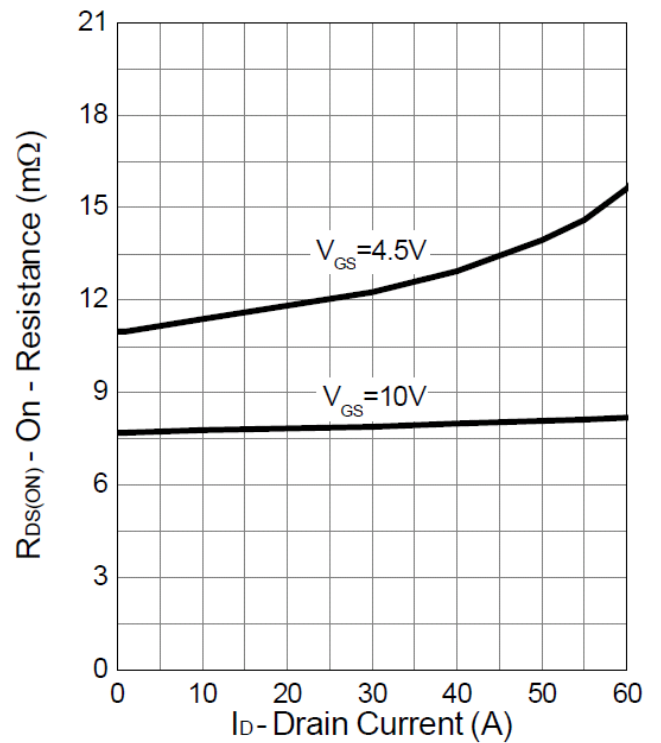

Dual N-Channel Enhancement Mode MOSFET TDM3484

Typical Operating Characteristics(Cont.)

Gate-Source On Resistance

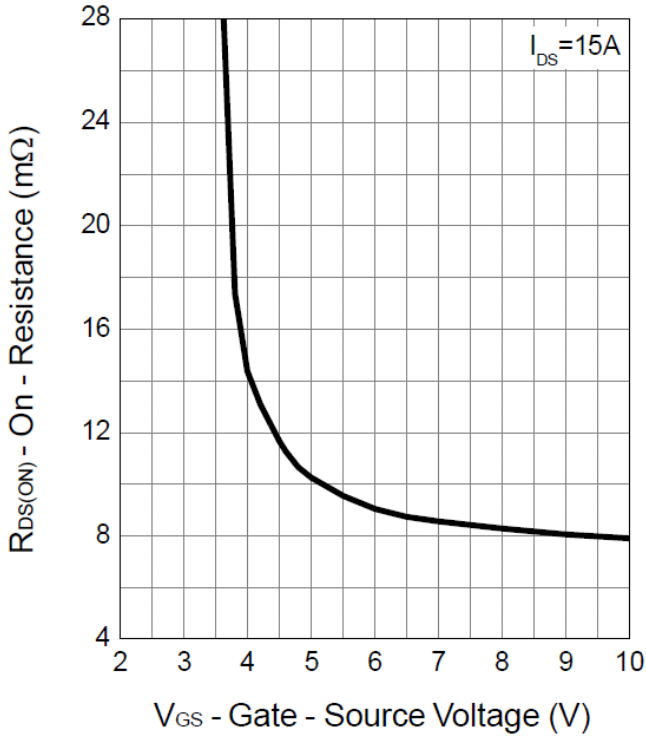

Gate Threshold Voltage

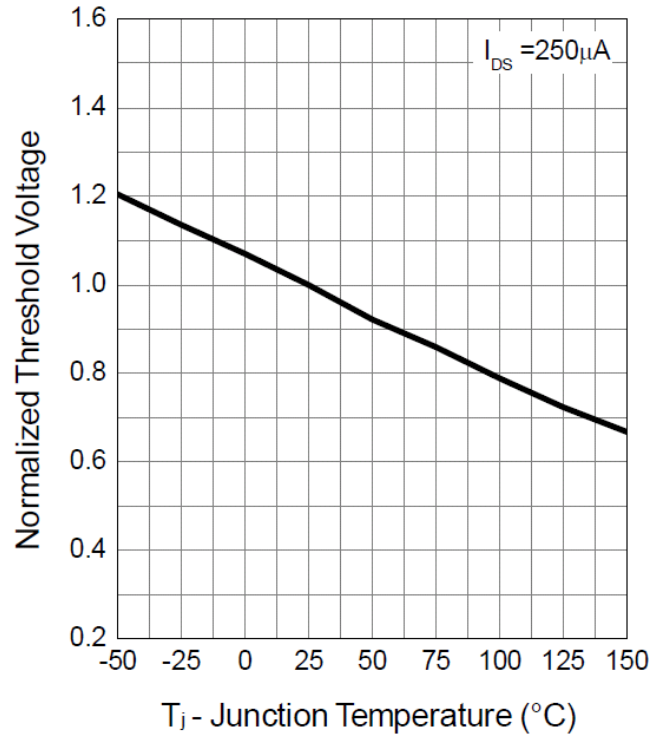

Drain-Source On Resistance

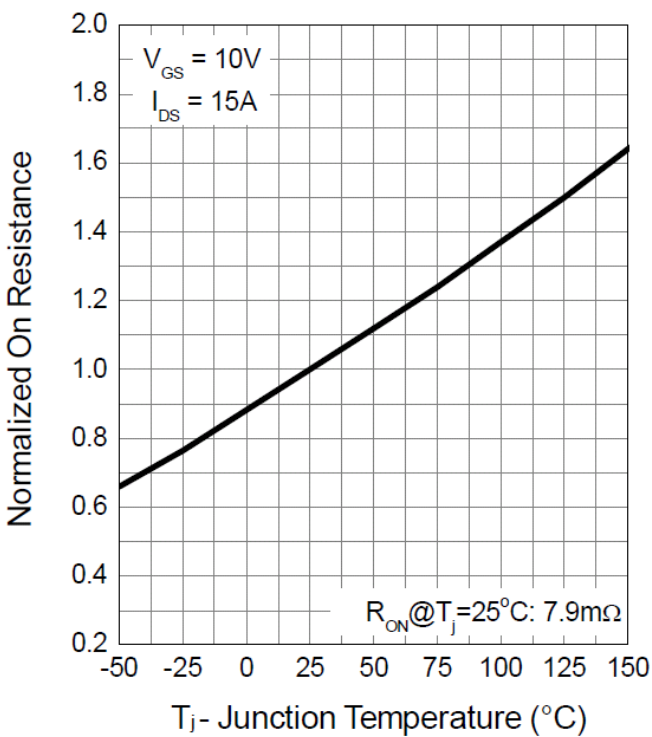

Source-Drain Diode Forward

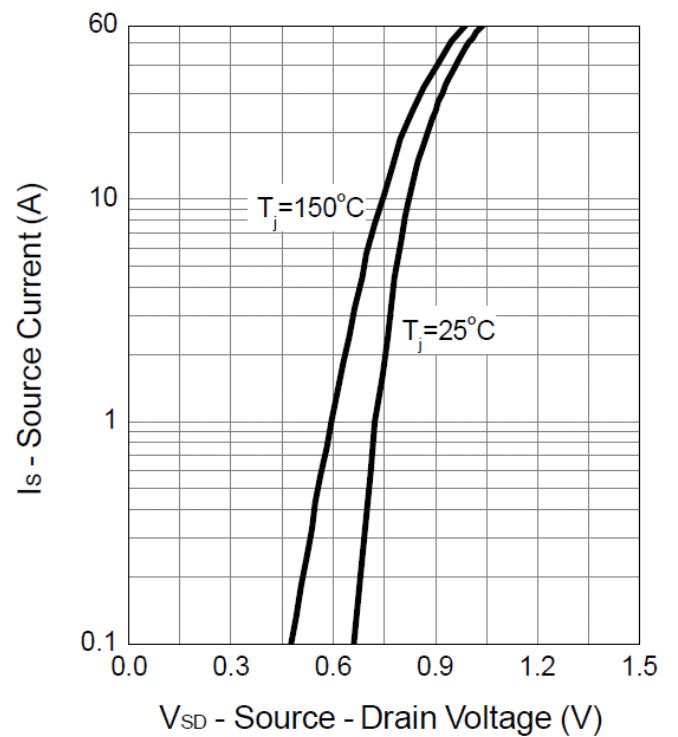

Dual N-Channel Enhancement Mode MOSFET TDM3484

Typical Operating Characteristics(Cont.)

Capacitance

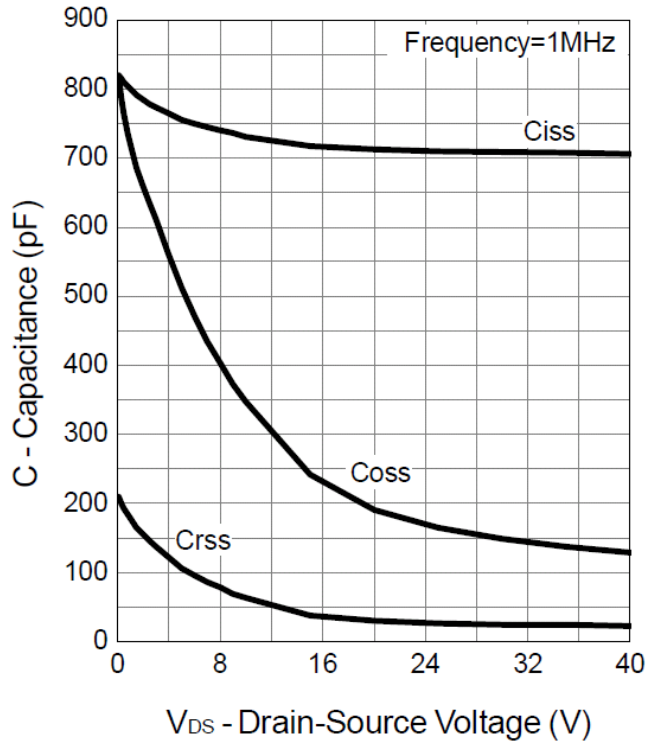

Gate Charge

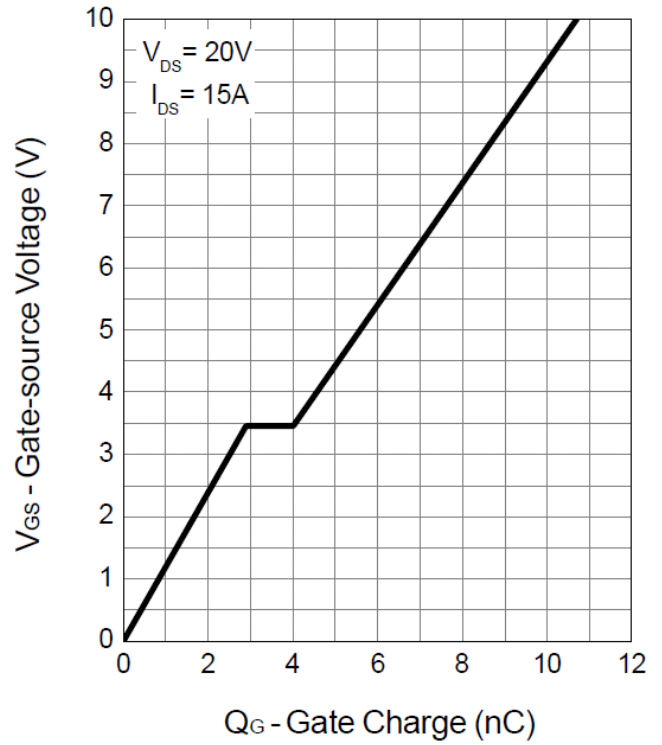

Transfer Characteristics

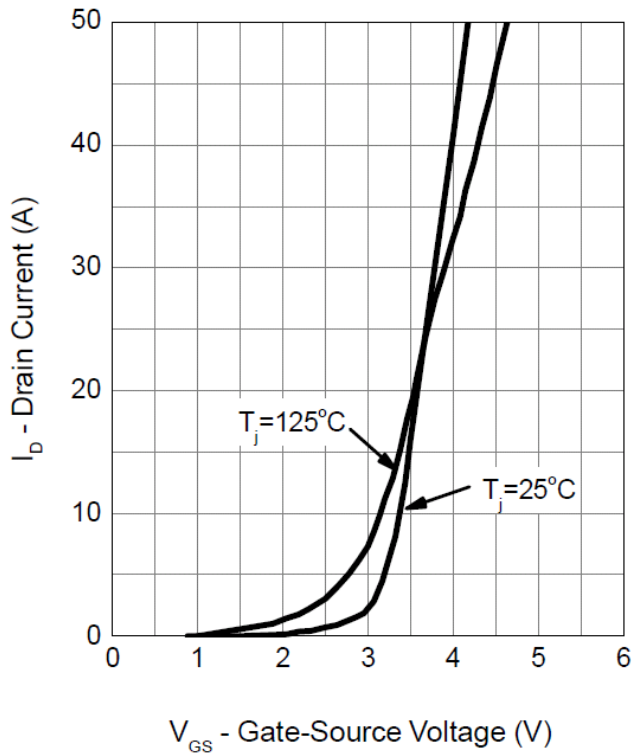

Package Information

SOP-8 Package

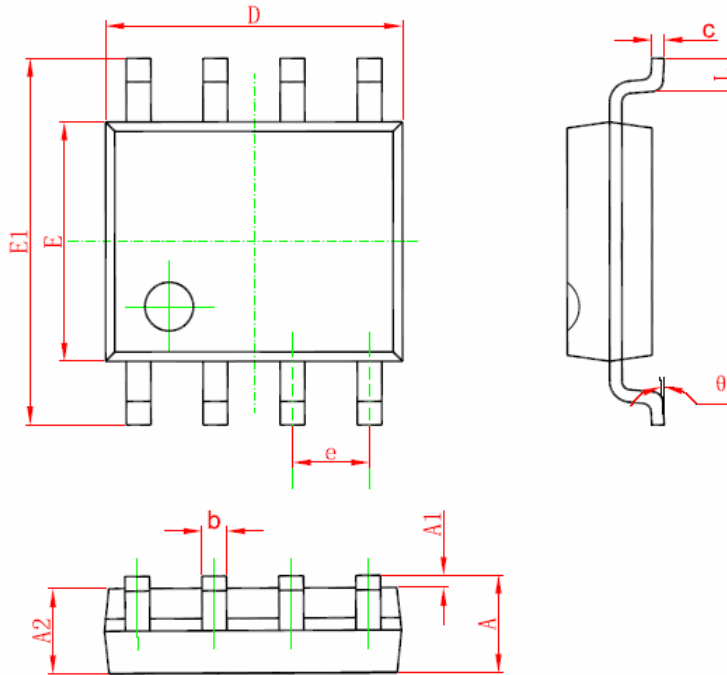

Symbol	Dimensions In Millimeters		Dimensions In Inches	
	Min	Max	Min	Max
A	1.350	1.750	0.053	0.069
A1	0.100	0.250	0.004	0.010
A2	1.350	1.550	0.053	0.061
b	0.330	0.510	0.013	0.020
c	0.170	0.250	0.006	0.010
D	4.700	5.100	0.185	0.200
E	3.800	4.000	0.150	0.157
E1	5.800	6.200	0.228	0.244
e	1.270 (BSC)		0.050 (BSC)	
L	0.400	1.270	0.016	0.050
θ	0°	8°	0°	8°

Design Notes



## X-ON Electronics

Largest Supplier of Electrical and Electronic Components

*Click to view similar products for [MOSFET](#) category:*

*Click to view products by [Techcode](#) manufacturer:*

Other Similar products are found below :

[614233C](#) [648584F](#) [MCH3443-TL-E](#) [MCH6422-TL-E](#) [FDPF9N50NZ](#) [FW216A-TL-2W](#) [FW231A-TL-E](#) [APT5010JVR](#) [NTNS3A92PZT5G](#)  
[IRF100S201](#) [JANTX2N5237](#) [2SK2464-TL-E](#) [2SK3818-DL-E](#) [FCA20N60\\_F109](#) [FDZ595PZ](#) [STD6600NT4G](#) [FSS804-TL-E](#) [2SJ277-DL-E](#)  
[2SK1691-DL-E](#) [2SK2545\(Q,T\)](#) [D2294UK](#) [405094E](#) [423220D](#) [MCH6646-TL-E](#) [TPCC8103,L1Q\(CM](#) [367-8430-0972-503](#) [VN1206L](#)  
[424134F](#) [026935X](#) [051075F](#) [SBVS138LT1G](#) [614234A](#) [715780A](#) [NTNS3166NZT5G](#) [751625C](#) [873612G](#) [IRF7380TRHR](#)  
[IPS70R2K0CEAKMA1](#) [RJK60S3DPP-E0#T2](#) [RJK60S5DPK-M0#T0](#) [APT5010JVFR](#) [APT12031JFLL](#) [APT12040JVR](#) [DMN3404LQ-7](#)  
[NTE6400](#) [JANTX2N6796U](#) [JANTX2N6784U](#) [JANTXV2N5416U4](#) [SQM110N05-06L-GE3](#) [SIHF35N60E-GE3](#)