

**Features:**

- Long operating life
- Low Power Consumption
- Low voltage DC operated
- RoHS Compliant

**Application:**

- Status indicator
- Industrial control panel
- Sensor status indication
- Wearable and portable devices



Part Number	Dice Material	Emitted Color	Lens Color
E6Q0603VGAC1UDA	InGaN	Green	Water Clear

**Electro-Optical Characteristics** ( $T_a=25^{\circ}\text{C}$ , @20mA)

Parameter	Symbol	Min.	Typ.	Max.	Unit
Luminous Intensity	IV	2000	-	3000	mcd
Radiation Bandwidth	$\Delta\lambda$	-	35	-	nm
Forward Voltage	VF	2.90	3.00	3.40	v
Luminous Flux	$\Phi$	-	-	-	Lm
Dominant Wavelength	$\lambda_d$	515	520	527	nm
CIE Coordinates CIE	x,y	-	-	-	-
Color Temperature	Tc	-	-	-	k
Viewing Angle	$2\theta_{1/2}$	-	30	-	deg
Reverse Current	IR	-	-	10	$\mu\text{A}$

**Absolute Maximum Ratings** ( $T_a=25^{\circ}\text{C}$ )

Parameter	Symbol	Max.	Unit
Peak Forward Current(1/10 Duty Cycle, 0.1ms Pulse Width)	IPF	100	mA
Forward Current	IF	30	mA
Reverse Voltage	VR	5	v
Electrostatic Discharge	ESD	2000	v
Operating Temperature Range	Topr	-40to+90	$^{\circ}\text{C}$
Storage Temperature Range	Tstg	-40to+90	$^{\circ}\text{C}$
Reflow Soldering	Tsld	260 $^{\circ}\text{C}$ for 10secs	



### Optical & Electrical Characteristics

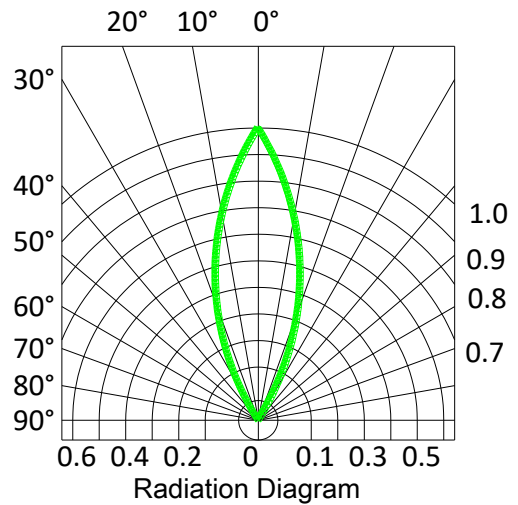
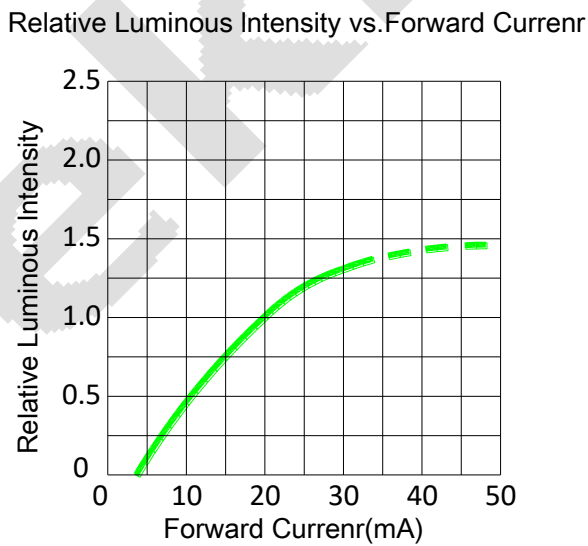
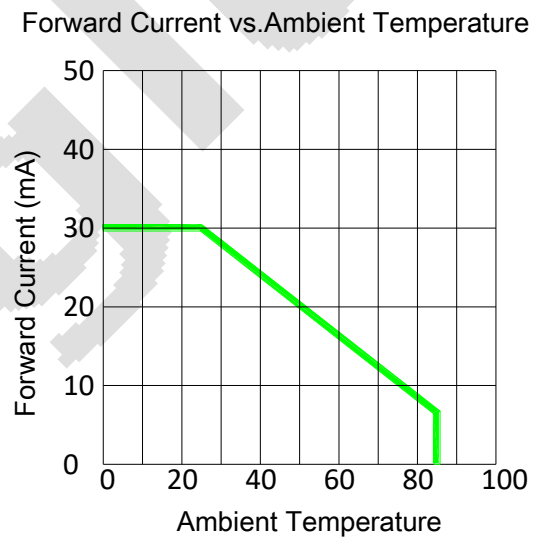
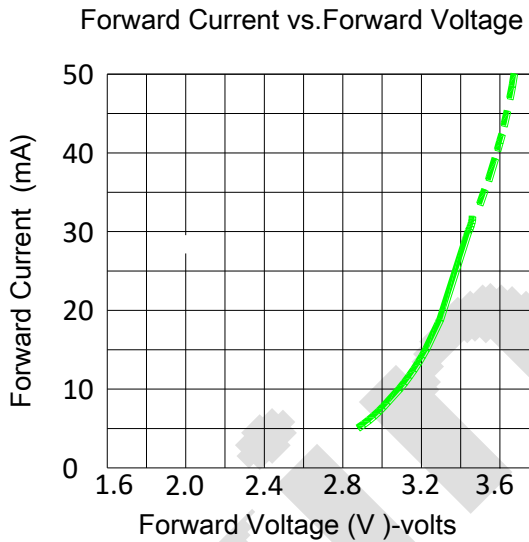
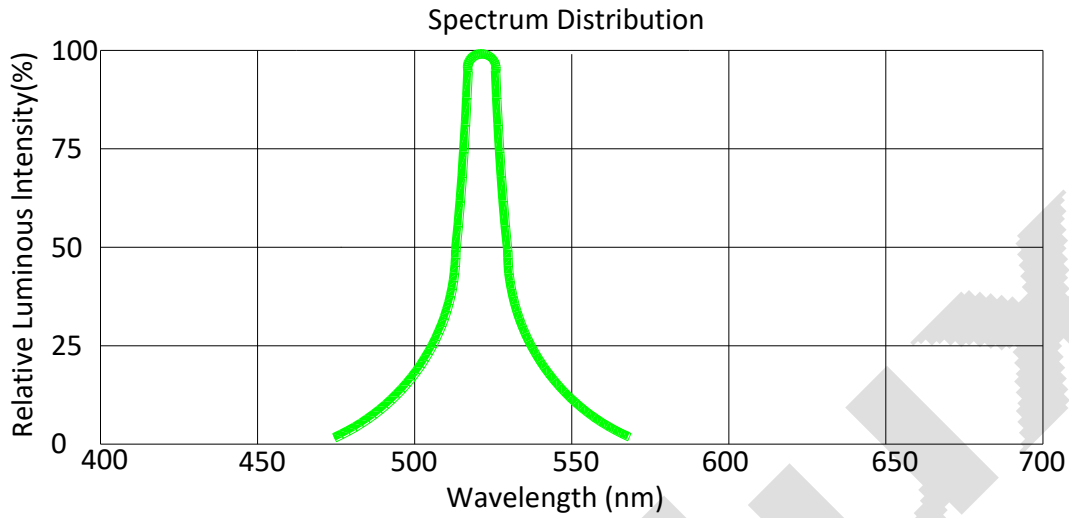



### Bin Limits

#### Bin Range Of Luminous Intensity (Unit:mcd)

Bin Code	Min	Max	Condition
L1	2000	2500	IF=20mA
L2	2500	3000	
L3	-	-	

#### Bin Range Of Forward Voltage (Unit:V)

Bin Code	Min	Max	Condition
V1	2.9	3.0	IF=20mA
V2	3.0	3.1	
V3	3.1	3.2	
V4	3.2	3.3	
V5	3.3	3.4	

#### Bin Range Of Wavelength (Unit:nm)

Bin Code	Min	Max	Condition
G1	515	517	IF=20mA
G2	517	519	
G3	519	521	
G4	521	523	
G5	523	525	
G6	525	527	

Notes:

- 1.Tolerance of Luminous Intensity  $\pm 10\%$
- 2.Tolerance of Forward Voltage  $\pm 0.1V$

**Reliability Test Items And Conditions**

Test Items	Reference	Test Conditions	Time	Quantity	Criterion
Thermal Shock	MIL-STD-202G	-40°C (30min) -100°C (30min)	100 Cycles	22	0/22
Temperature And Humidity Cyclic	JEITA ED-4701 200 203	-10°C~65°C ; 0%~90%RH	10cycles	22	0/22
High Temperature Storage	JEITA ED -4071 200 201	Ta=100°C	1000H	22	0/22
Low Temperature Storage	JEITA ED -4071 200 202	Ta=-40°C	1000H	22	0/22
High Temperature High Humidity Storage	JEITA ED -4071 100 103	Ta=60°C ; RH=90%	1000H	22	0/22
High Temperature Life Test	JESD22-A108D	Ta=80°C	1000H	22	0/22
Life Test	JESD22-A108D	Ta=25°C IF=20mA	1000H	22	0/22
Resistance to Soldering Heat	GB/T 4937, II , 2.2&2.3	Tsol*=(240±5) °C 10secs	2 times	22	0/22

**Criteria For Judging Damage**

Test Items	Symbol	Test Conditions	Criteria For Judging Damage
Forward Voltage	$V_F$	$I_F=I_{FT}$	Initial Data±10%
Reverse Current	$I_R$	$V_R=5V$	$I_R \leq 10\mu A$
Luminous Intensity	$I_V$	$I_F=I_{FT}$	Average $I_V$ degradation ≤30% ; Single LED $I_V$ degradation ≤50%
Resistance to Soldering Heat	-	-	Material without internal cracks, no material between stripped, no dead light



### Product size (Unit:mm)

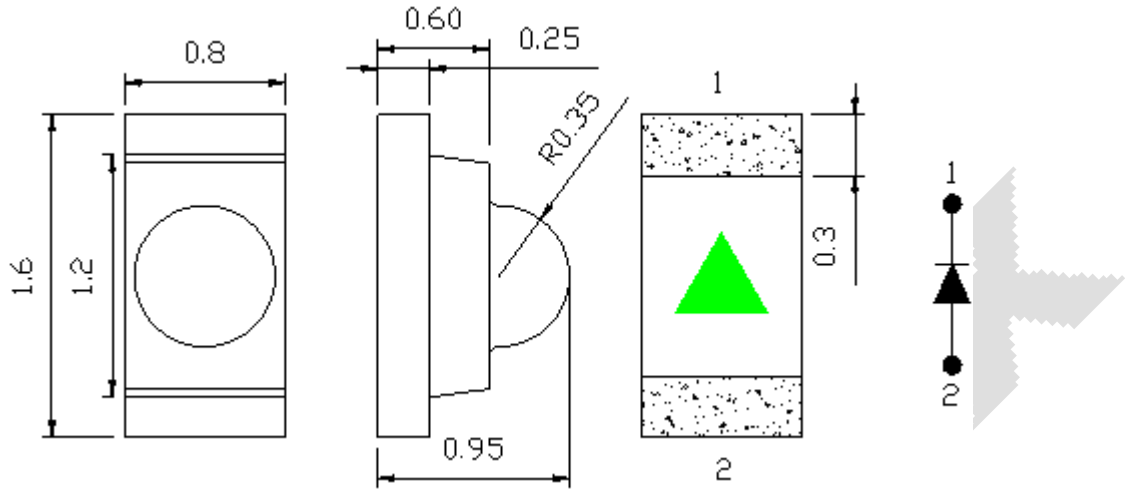

#### NOTES :

1. All dimensions are in millimeters (inches)
2. Tolerances are  $\pm 0.2\text{mm}$  (0.008inch) unless otherwise noted

### Recommended Soldering Pad Design (Unit:mm)

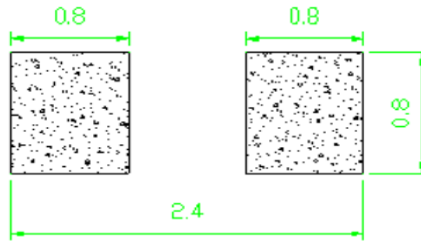

### Taping and package Spec

- Tape Specification:4,000pcs Per Reel

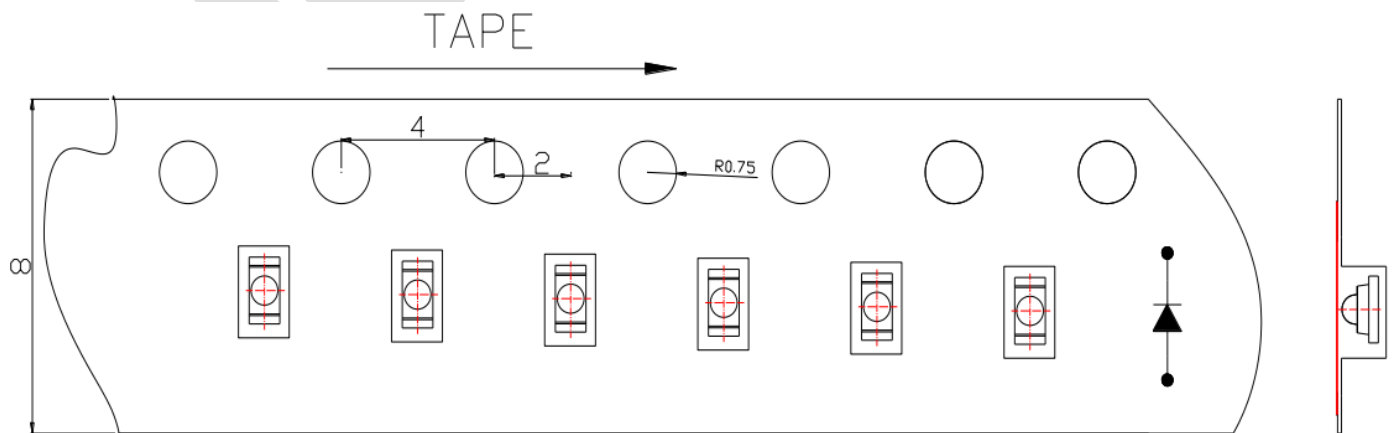



### Packaging

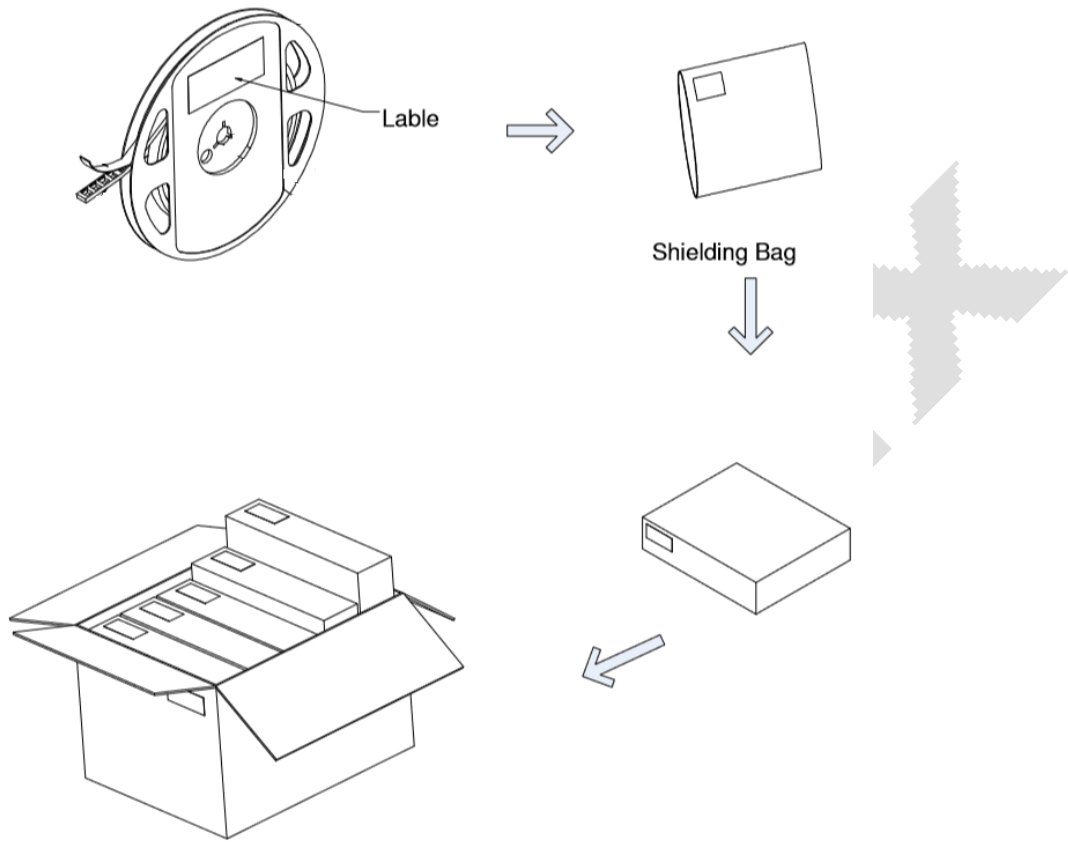

### LabelStyle

EKINGLUX OPTOELECTRONICS(SHANGHAI) CO.,LTD



P/N:E6C1206QBAC1UDA

Emitting Color: Blue

HUE: 466-468 nm



IV :100-150 mcd

VF: 3.0-3.2 V *example* BIN Code: 2

QTY: 3000 PCS DATE: 2018/06/06



LOT NO.:1806103



### Useful hint

### Reflow Soldering Instructions

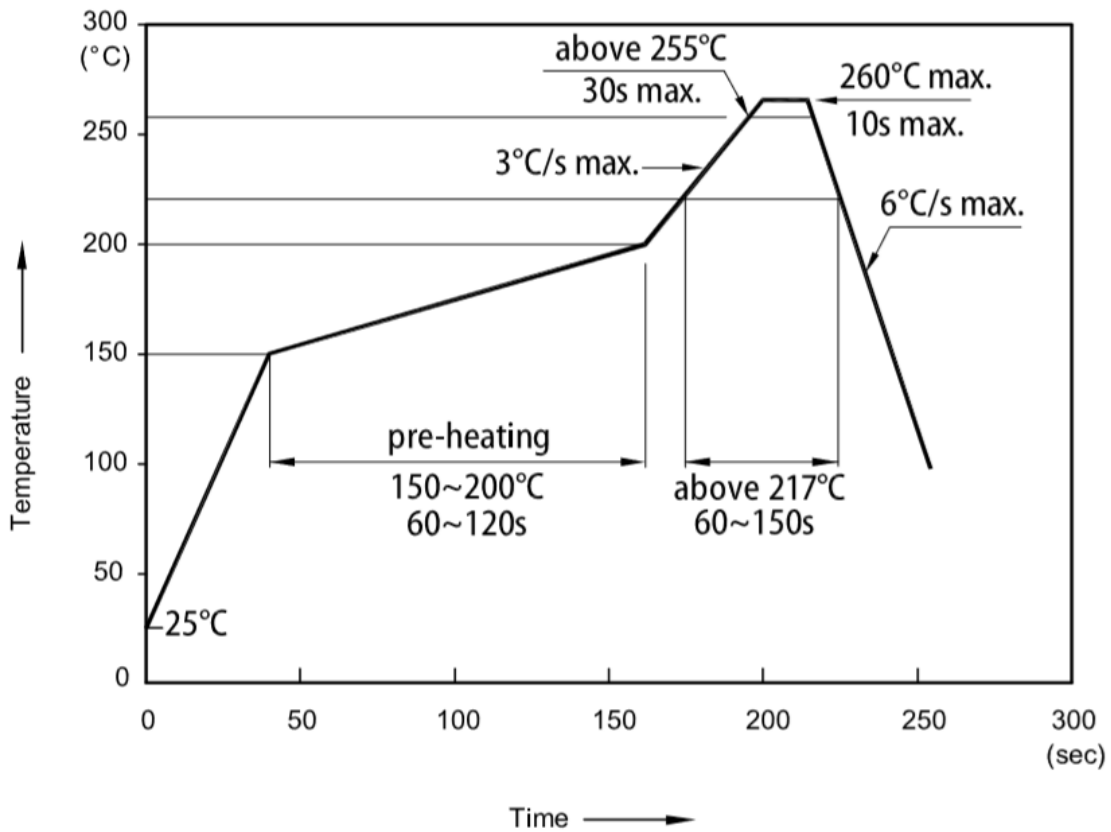

1. Don't cause stress to the LEDs while it is exposed to high temperature.
2. The maximum number of reflow soldering passes is 2 times.
3. Reflow soldering is recommended. Other soldering methods are not recommended as they might cause damage to the product.



## Precautions

### 1. Storage:

- Moisture proof and anti-electrostatic package with moisture absorbent material is used, to keep moisture to a minimum.
- Before opening the package, the product should be kept at 30°C or less and humidity less than 60% RH, and be used within a year.
- After opening the package, the product should be stored at 30°C or less and humidity less than 10%RH, and be soldered within 24 hours (1day). It is recommended that the product be operated at the workshop condition of 30°C or less and humidity less than 60%RH.
- If the moisture absorbent material has faded away or the LEDs have exceeded the storage time, baking treatment should be performed based on the following condition: (70±5)°C for 24 hours.

### 2. Static Electricity:

Static electricity or surge voltage damages the LEDs. Damaged LEDs will show some unusual characteristics such as the forward voltage becoming lower, or the LEDs do not light at the low current, even not light.

All devices, equipment and machinery must be properly grounded. At the same time, it is recommended that wrist bands or anti-electrostatic gloves, anti-electrostatic containers be used when dealing with the LEDs.

### 3. Vulcanization:

LED curing is due to sulfur being in brackets and the +1 price of silver in the chemical reaction generated Ag<sub>2</sub>S in the process. It will lead to the capacity of reflecting of silver layer reducing, light color temperature drift and serious decline, seriously affecting the performance of the product. So we should take corresponding measures to avoid vulcanization, such as to avoid using sulphur volatile substances and keeping away from high sulphur content of the material.



## X-ON Electronics

Largest Supplier of Electrical and Electronic Components

*Click to view similar products for [Standard LEDs - SMD category](#):*

*Click to view products by [EKINGLUX manufacturer](#):*

Other Similar products are found below :

[LTST-C19GD2WT](#) [LTST-N683GBEW](#) [597-3006-607F](#) [597-3403-607F](#) [LTW-K140SZR40](#) [LTW-M140ZVS](#) [598-8110-100F](#) [598-8170-100F](#)  
[598-8610-202F](#) [7012X7](#) [AAAF5060QBFSEEZGS](#) [12-22SURSYGC/S530-A3/E2/TR8](#) [1383SURT/S530-A3/TR1\(R\)](#) [APT1608QGW](#)  
[EASV1803BA0](#) [SML310BATT86](#) [SML-512VWT86A](#) [SML-LX0606SISUGC/A](#) [SML-LXL1307SRC-TR](#) [SML-LXR851SIUPGUBC](#)  
[LT1ED53A](#) [17-21/G6C-FM1N2B/3T](#) [FAT801-S](#) [SSL-LXA227IC-TR31A](#) [AM27ZGC03](#) [APB3025SGNC](#) [APHK1608VGCA](#) [APT2012QGW](#)  
[CLMVC-FKA-CA1E1L81BB7C3C3](#) [CLYBA-FKA-CFHHL9BBB7A363](#) [CMD11504UR](#) [LTW-020ZDCG](#) [LTW-21TS5](#) [LTW-K140SZR30](#)  
[HSMY-C177](#) [HT-121UYG-4739](#) [UYGT801-S](#) [KVH1C100MF6R](#) [42-21SYGC/S530-E1/TR8](#) [YGFR411-H](#) [597-2311-402F](#) [597-2712-602F](#)  
[5973212407NF](#) [597-3302-607F](#) [597-5202-407F](#) [598-8330-117F](#) [SAW8WA2A-L35M40-CA](#) [SML013WBDW1](#) [SML522BUWT86](#) [SML-](#)  
[LX0402IC-TR](#)