

SE2300

N-Channel Enhancement-Mode MOSFET

Revision: A

General Description

Thigh Density Cell Design For Ultra Low On-Resistance Fully Characterized Avalanche Voltage and Current Improved Shoot-Through FOM

- Simple Drive Requirement
- Small Package Outline
- Surface Mount Device

Features

For a single MOSFET

- $V_{DS} = 20V$
- $R_{DS(ON)} = 50m\Omega @ V_{GS}=2.5V$
- $R_{DS(ON)} = 40m\Omega @ V_{GS}=4.5V$

Pin configurations

See Diagram below

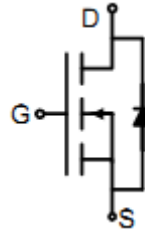
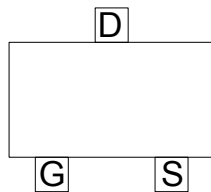

Absolute Maximum Ratings

Parameter		Symbol	Rating	Units
Drain-Source Voltage		V_{DS}	20	V
Gate-Source Voltage		V_{GS}	± 10	V
Drain Current	Continuous	I_D	5.9	A
	Pulsed		23	
Total Power Dissipation	@TA=25°C	P_D	1.2	W
Operating Junction Temperature Range		T_J	-55 to 150	°C

SE2300

Electrical Characteristics (T _J =25°C unless otherwise noted)						
Symbol	Parameter	Test Conditions	Min	Typ	Max	Units
OFF CHARACTERISTICS (Note 2)						
BV _{DSS}	Drain-Source Breakdown Voltage	I _D =250μA, V _{GS} =0 V	20			V
I _{DSS}	Drain to Source Leakage Current	V _{DS} = 20V, V _{GS} =0V			1	μA
I _{GSS}	Gate-Body Leakage Current	V _{GS} =10 V			100	nA
V _{GS(th)}	Gate Threshold Voltage	V _{DS} = V _{GS} , I _D =250μA	1	1.7	3.0	V
R _{DS(ON)}	Static Drain-Source On-Resistance ²	V _{GS} =2.5V, I _D =4A	-	34	50	mΩ
		V _{GS} =4.5V, I _D =4.5A		28	40	
DYNAMIC PARAMETERS						
C _{iss}	Input Capacitance	V _{GS} =0V, V _{DS} =105V, f=1MHz		500		pF
C _{oss}	Output Capacitance			250		pF
C _{rss}	Reverse Transfer Capacitance			90		pF
SWITCHING PARAMETERS						
Q _g	Total Gate Charge ²	V _{GS} =4.2V, V _{DS} =10V, I _D =4.2A		10		nC
Q _{gs}	Gate Source Charge			2.3		nC
Q _{gd}	Gate Drain Charge			2.9		nC
t _{d(on)}	Turn-On Delay Time	V _{GS} =4.5V, V _{DS} =10V, R _{GEN} =6Ω I _D =3.6A		7		ns
t _{d(off)}	Turn-Off Delay Time			16		ns
t _{d(r)}	Turn-On Rise Time			55		ns
t _{d(f)}	Turn-Off Fall Time			10		ns
Thermal Resistance						
Symbol	Parameter		Typ	Max	Units	
R _{θJA}	Junction to Ambient (t ≤ 10s)		-	140	°C/W	

Test Circuits and Waveform

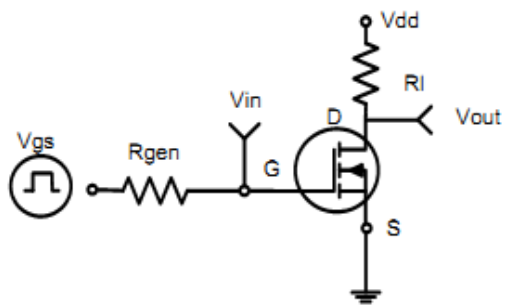

Figure 1: Switching Test Circuit

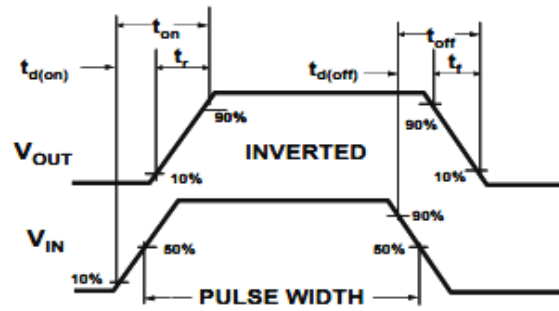

Figure 2: Switching Waveforms

Typical Characteristics

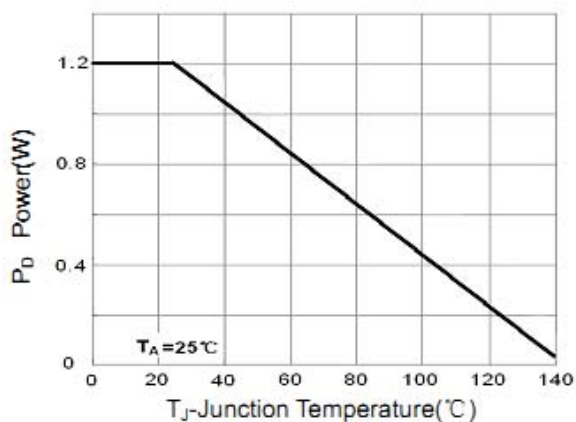

Figure 3 Power Dissipation

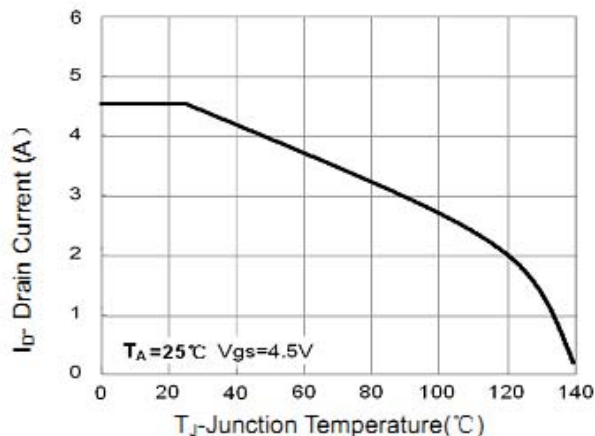

Figure 4 Drain Current

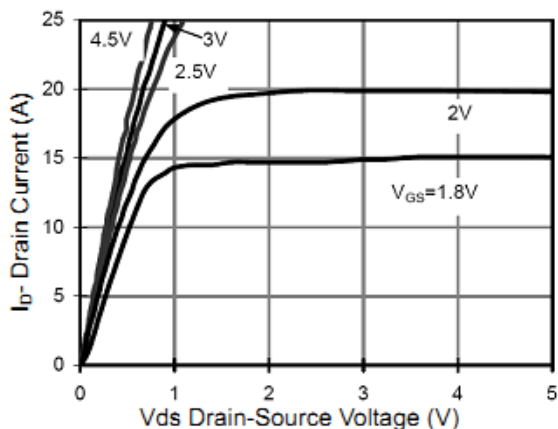

Figure 5 Output CHARACTERISTICS

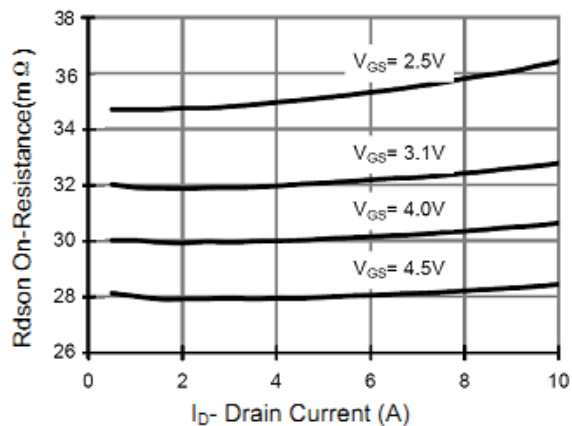

Figure 6 Drain-Source On-Resistance

Typical Characteristics

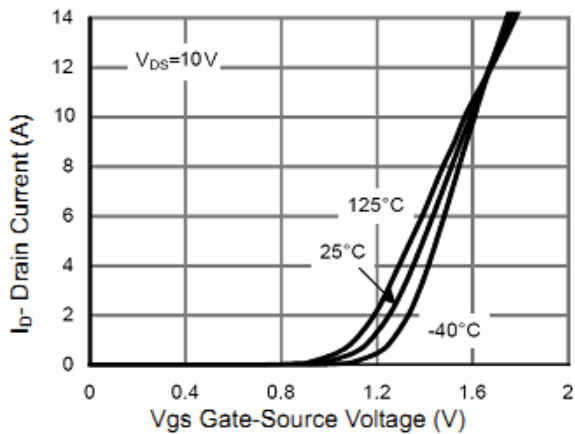

Figure 7 Transfer Characteristics

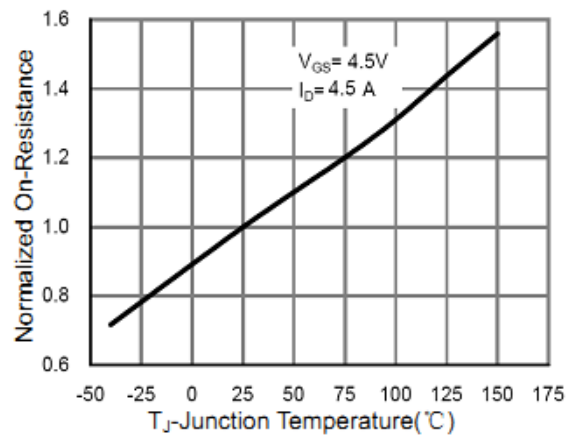

Figure 8 Drain-Source On-Resistance

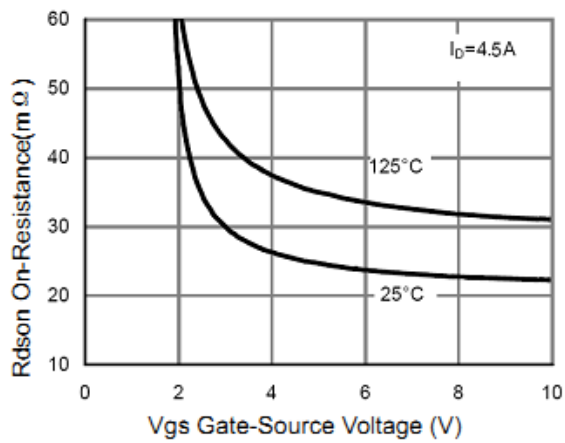

Figure 9 Rdson vs Vgs

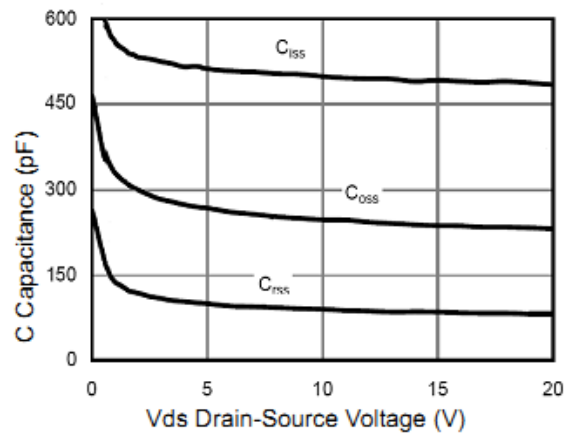

Figure 10 Capacitance vs Vds

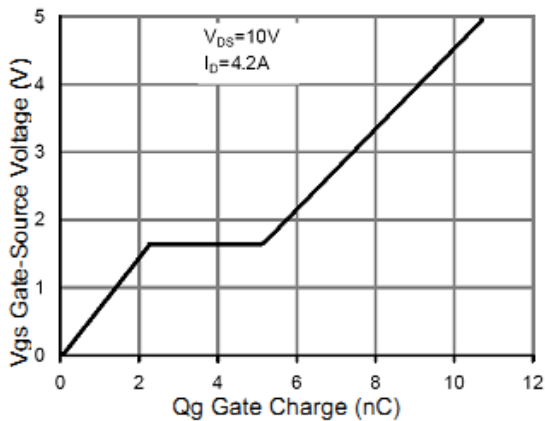

Figure 11 Gate Charge

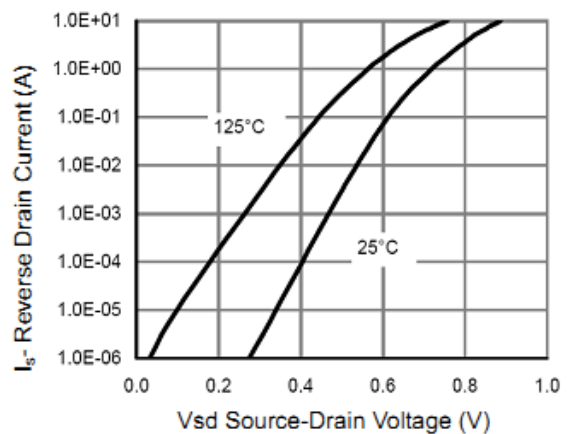

Figure 12 Source-Drain Diode Forward

Typical Characteristics

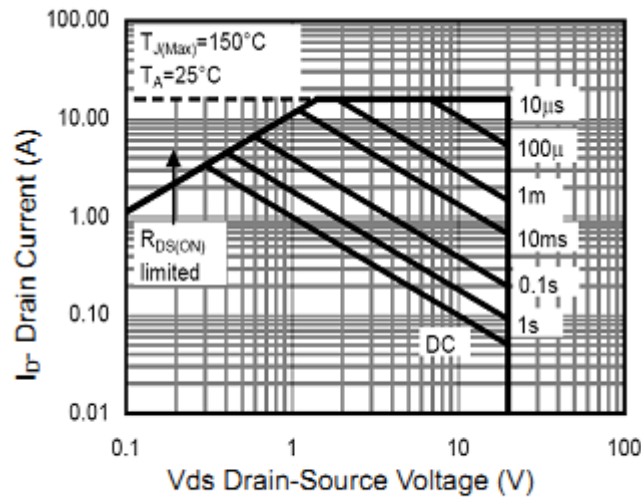

Figure 13 Safe Operation Area

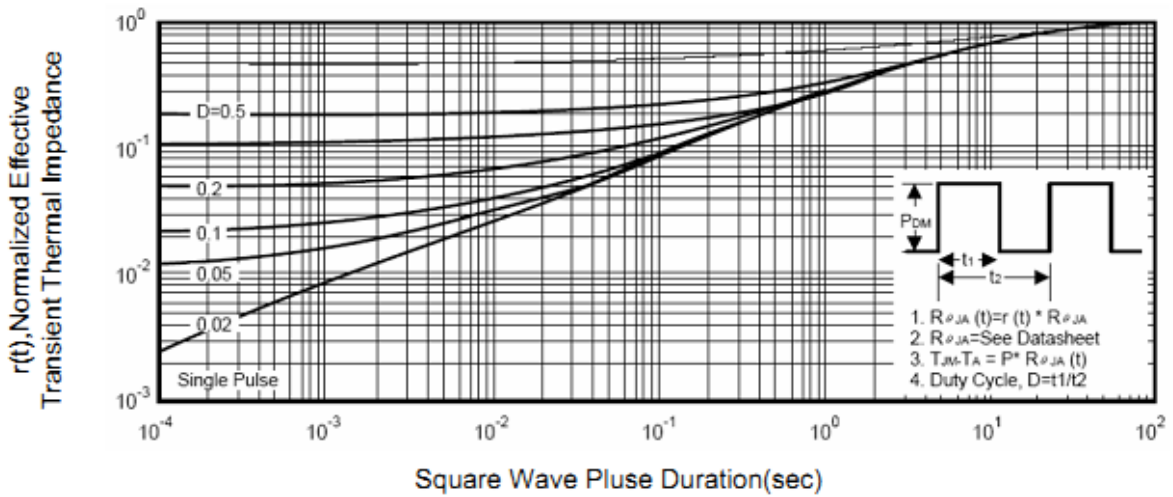
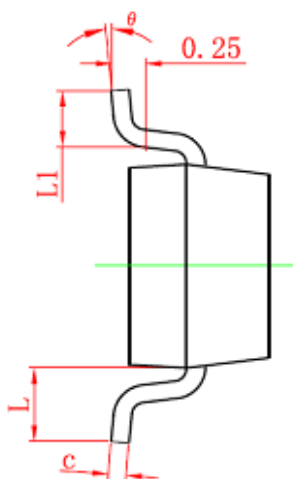
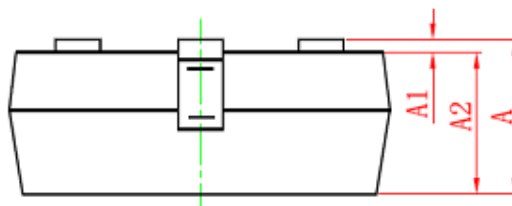
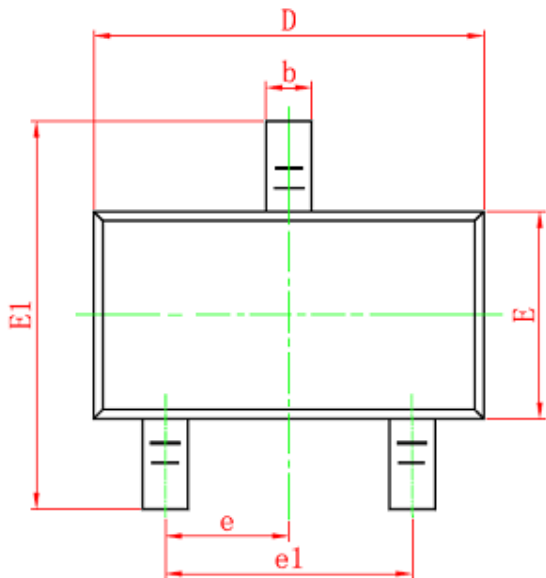

Figure 14 Normalized Maximum Transient Thermal Impedance

SE2300

Package Outline Dimension

SOT-23



Symbol	Dimensions in Millimeters	
	MIN.	MAX.
A	0.900	1.150
A1	0.000	0.100
A2	0.900	1.050
b	0.300	0.500
c	0.080	0.150
D	2.800	3.000
E	1.200	1.400
E1	2.250	2.550
e	0.950TYP	
e1	1.800	2.000
L	0.550REF	
L1	0.300	0.500
θ	0°	8°

The SINO-IC logo is a registered trademark of ShangHai Sino-IC Microelectronics Co., Ltd.

© 2005 SINO-IC - Printed in China - All rights reserved.

SHANGHAI SINO-IC MICROELECTRONICS CO., LTD

Add: Building 3, Room 3401-03, No.200 Zhangheng Road,
ZhangJiang Hi-Tech Park, Pudong, Shanghai 201203, China

Phone: +86-21-33932402 33932403

33932405 33933508 33933608

Fax: +86-21-33932401

Email: webmaster@sino-ic.com

Website: <http://www.sino-ic.com>

X-ON Electronics

Largest Supplier of Electrical and Electronic Components

Click to view similar products for [MOSFET](#) category:

Click to view products by [SINO-IC](#) manufacturer:

Other Similar products are found below :

[614233C](#) [648584F](#) [MCH3443-TL-E](#) [MCH6422-TL-E](#) [FDPF9N50NZ](#) [FW216A-TL-2W](#) [FW231A-TL-E](#) [APT5010JVR](#) [NTNS3A92PZT5G](#)
[IRF100S201](#) [JANTX2N5237](#) [2SK2464-TL-E](#) [2SK3818-DL-E](#) [FCA20N60_F109](#) [FDZ595PZ](#) [STD6600NT4G](#) [FSS804-TL-E](#) [2SJ277-DL-E](#)
[2SK1691-DL-E](#) [2SK2545\(Q,T\)](#) [D2294UK](#) [405094E](#) [423220D](#) [MCH6646-TL-E](#) [TPCC8103,L1Q\(CM](#) [367-8430-0972-503](#) [VN1206L](#)
[424134F](#) [026935X](#) [051075F](#) [SBVS138LT1G](#) [614234A](#) [715780A](#) [NTNS3166NZT5G](#) [751625C](#) [873612G](#) [IRF7380TRHR](#)
[IPS70R2K0CEAKMA1](#) [RJK60S3DPP-E0#T2](#) [RJK60S5DPK-M0#T0](#) [APT5010JVFR](#) [APT12031JFLL](#) [APT12040JVR](#) [DMN3404LQ-7](#)
[NTE6400](#) [JANTX2N6796U](#) [JANTX2N6784U](#) [JANTXV2N5416U4](#) [SQM110N05-06L-GE3](#) [SIHF35N60E-GE3](#)