

**20V N-CHANNEL Enhancement Mode MOSFET**

# MTN003N02Y3

BV <sub>DSS</sub>	20V
I <sub>D</sub>	560mA
R <sub>DS(on)</sub> @V <sub>GS</sub> =4V, I <sub>D</sub> =300mA	290mΩ (typ)
R <sub>DS(on)</sub> @V <sub>GS</sub> =2.5V, I <sub>D</sub> =300mA	440mΩ (typ)
R <sub>DS(on)</sub> @V <sub>GS</sub> =1.8V, I <sub>D</sub> =300mA	845mΩ (typ)

**Features**

- Simple drive requirement
- Small package outline
- ESD protected gate
- Pb-free lead plating and halogen-free package

**Symbol**

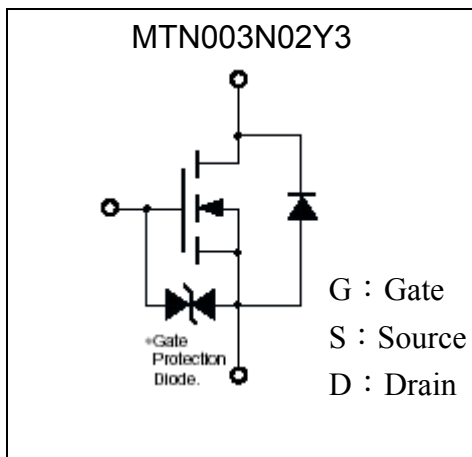

**Outline**

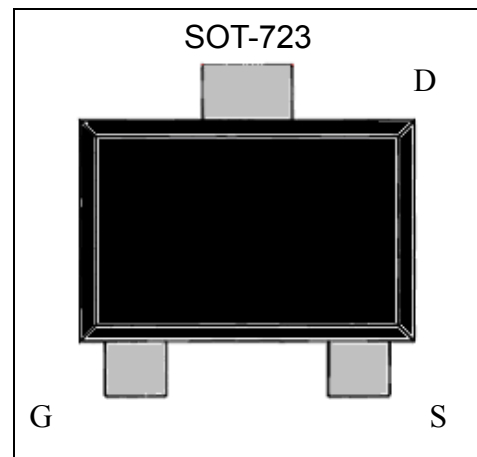

**Ordering Information**

Device	Package	Shipping
MTN003N02Y3-0-T5-G	SOT-723 (Pb-free lead plating and halogen-free package)	8000 pcs / tape & reel

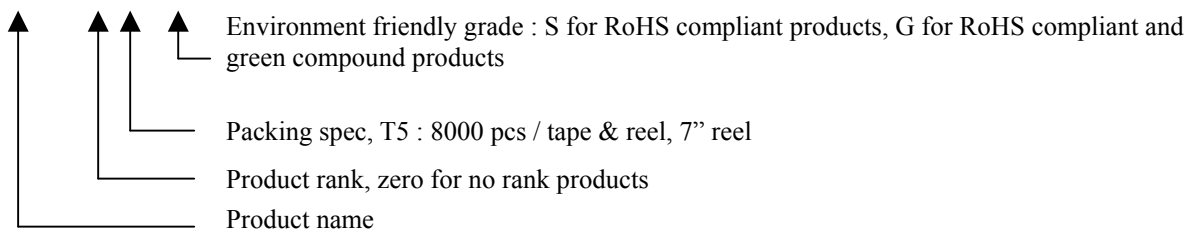



**Absolute Maximum Ratings (Ta=25°C)**

Parameter	Symbol	Limits	Unit	
Drain-Source Voltage	V <sub>DS</sub>	20	V	
Gate-Source Voltage	V <sub>GS</sub>	±8		
Continuous Drain Current @ T <sub>A</sub> =25°C, V <sub>GS</sub> =4.5V (Note 3)	I <sub>D</sub>	560	mA	
Continuous Drain Current @ T <sub>A</sub> =85°C, V <sub>GS</sub> =4.5V (Note 3)		400		
Pulsed Drain Current (Notes 1, 2)	I <sub>DM</sub>	2.5	A	
Maximum Power Dissipation (Note 3)	P <sub>D</sub>	T <sub>A</sub> =25°C	150	mW
		T <sub>A</sub> =85°C	80	
ESD susceptibility		2000 (Note 4)	V	
Operating Junction and Storage Temperature	T <sub>j</sub> , T <sub>stg</sub>	-55~+150	°C	

- Note : 1. Pulse width limited by maximum junction temperature.  
 2. Pulse width ≤ 300μs, duty cycle ≤ 2%.  
 3. Surface mounted on FR-4 board.  
 3. Human body model, 1.5kΩ in series with 100pF

**Thermal Performance**

Parameter	Symbol	Limit	Unit
Thermal Resistance, Junction-to-Ambient(PCB mounted)	R <sub>th,ja</sub>	833	°C/W

**Electrical Characteristics (Tj=25°C, unless otherwise noted)**

Symbol	Min.	Typ.	Max.	Unit	Test Conditions
<b>Static</b>					
BV <sub>DSS</sub>	20	-	-	V	V <sub>GS</sub> =0, I <sub>D</sub> =250μA
ΔBV <sub>DSS</sub> /ΔT <sub>j</sub>	-	0.02	-	V/°C	Reference to 25°C, I <sub>D</sub> =1mA
V <sub>GS(th)</sub>	0.5	0.92	1.2	V	V <sub>DS</sub> =10V, I <sub>D</sub> =1mA
I <sub>GSS</sub>	-	-	±10	μA	V <sub>GS</sub> =±8V, V <sub>DS</sub> =0
I <sub>DSS</sub>	-	-	1		V <sub>DS</sub> =20V, V <sub>GS</sub> =0
	-	-	10		V <sub>DS</sub> =16V, V <sub>GS</sub> =0 (T <sub>j</sub> =70°C)
*R <sub>DS(ON)</sub>	-	290	400	mΩ	V <sub>GS</sub> =4V, I <sub>D</sub> =300mA
	-	440	600		V <sub>GS</sub> =2.5V, I <sub>D</sub> =300mA
	-	845	1200		V <sub>GS</sub> =1.8V, I <sub>D</sub> =300mA
*G <sub>FS</sub>	-	0.9	-	S	V <sub>DS</sub> =10V, I <sub>D</sub> =300mA
<b>Dynamic</b>					
C <sub>iss</sub>	-	60	-	pF	V <sub>DS</sub> =10V, V <sub>GS</sub> =0, f=1MHz
C <sub>oss</sub>	-	14	-		
C <sub>rss</sub>	-	9	-		



$t_{d(ON)}$	-	5	-	ns	$V_{DS}=10V, I_D=150mA, V_{GS}=4V R_G=10\Omega$
$t_r$	-	5	-		
$t_{d(OFF)}$	-	24	-		
$t_f$	-	18	-		
$Q_g$	-	0.76	-	nC	$V_{DS}=10V, I_D=250mA, V_{GS}=4.5V$
$Q_{gs}$	-	0.074	-		
$Q_{gd}$	-	0.27	-		
<b>Source-Drain Diode</b>					
$*V_{SD}$	-	0.75	1.2	V	$V_{GS}=0V, I_S=100mA$

\*Pulse Test : Pulse Width  $\leq 300\mu s$ , Duty Cycle  $\leq 2\%$

**Typical Characteristics**

Typical Output Characteristics

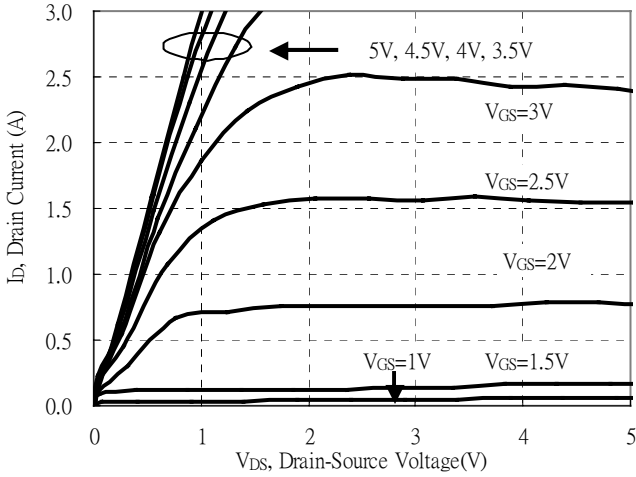

Brekdown Voltage vs Ambient Temperature

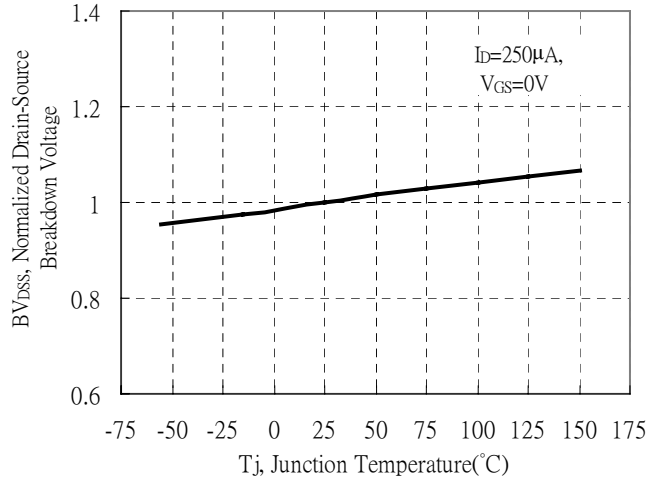

Static Drain-Source On-State resistance vs Drain Current

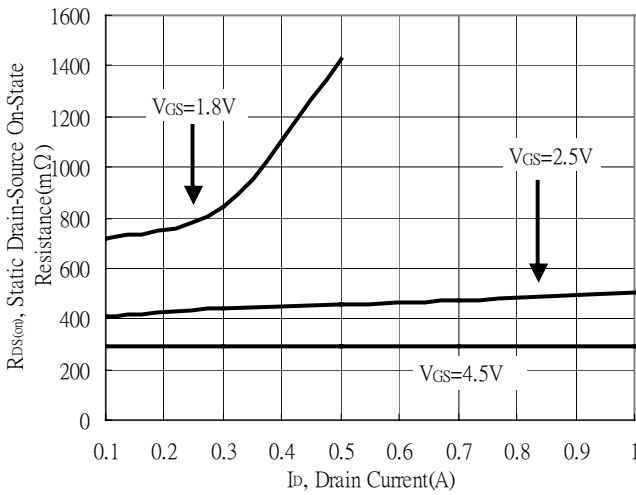

Reverse Drain Current vs Source-Drain Voltage

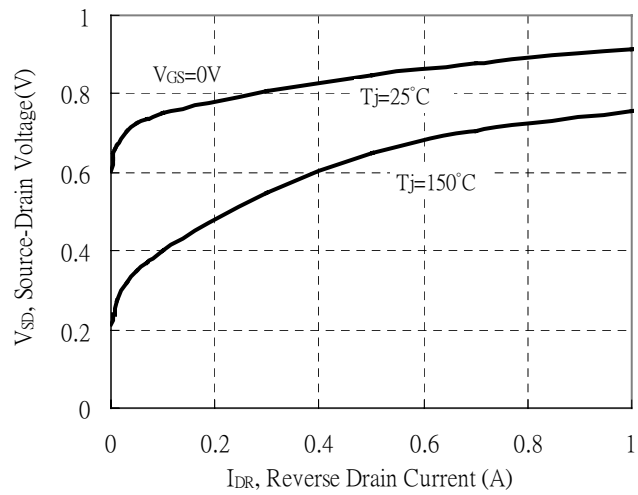

Static Drain-Source On-State Resistance vs Gate-Source Voltage

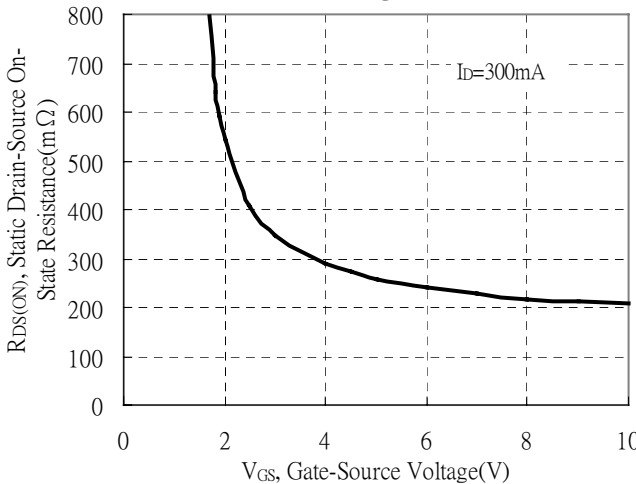

Drain-Source On-State Resistance vs Junction Temperature

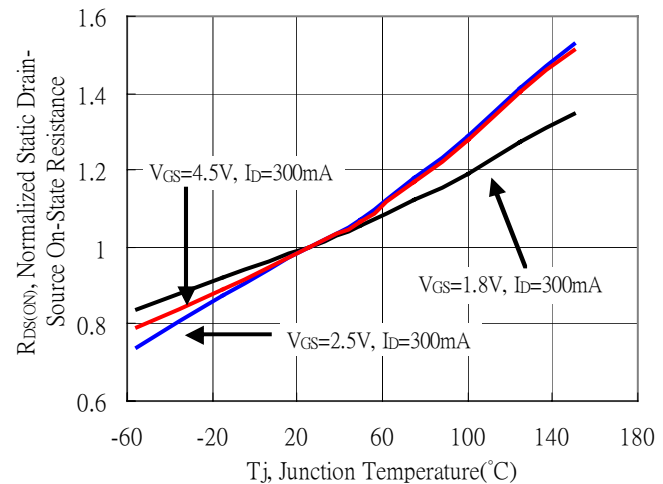



**Typical Characteristics(Cont.)**

Capacitance vs Drain-to-Source Voltage

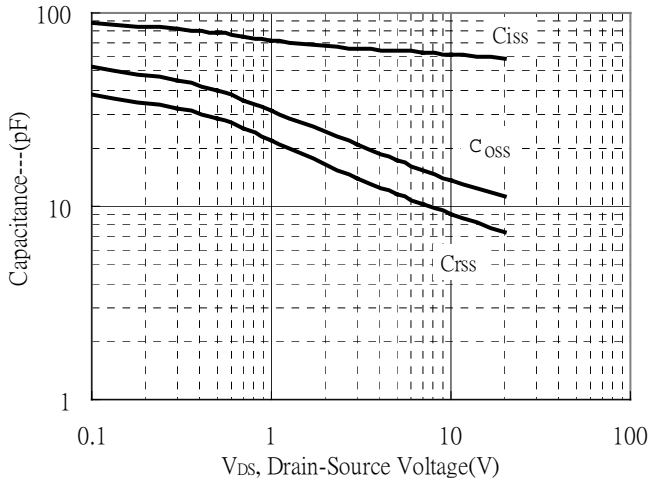

Threshold Voltage vs Junction Temperature

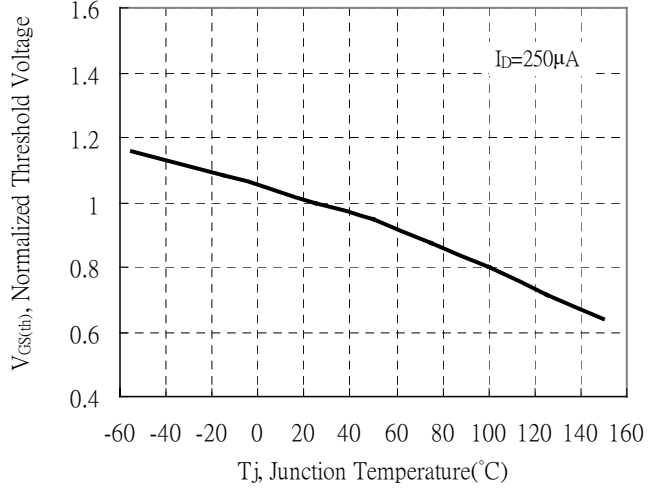

Single Pulse Power Rating, Junction to Ambient  
 (Note on page 2)

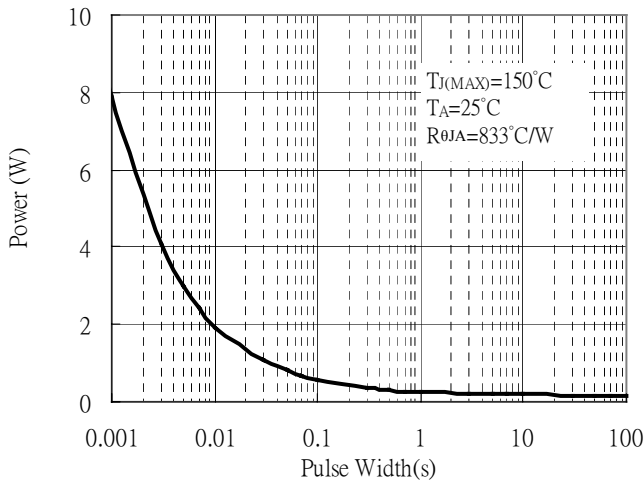

Gate Charge Characteristics

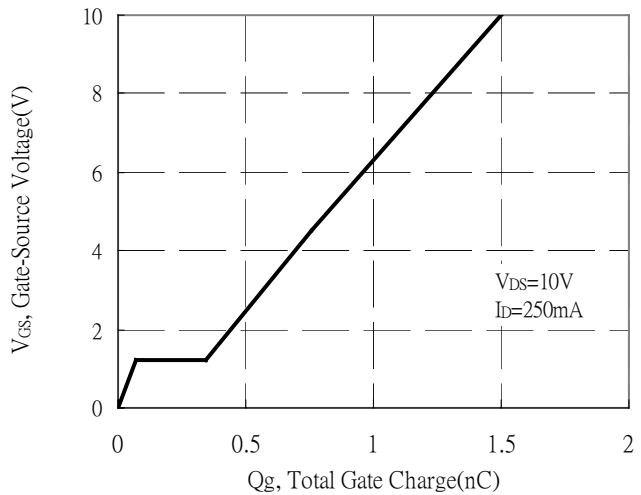

Maximum Safe Operating Area

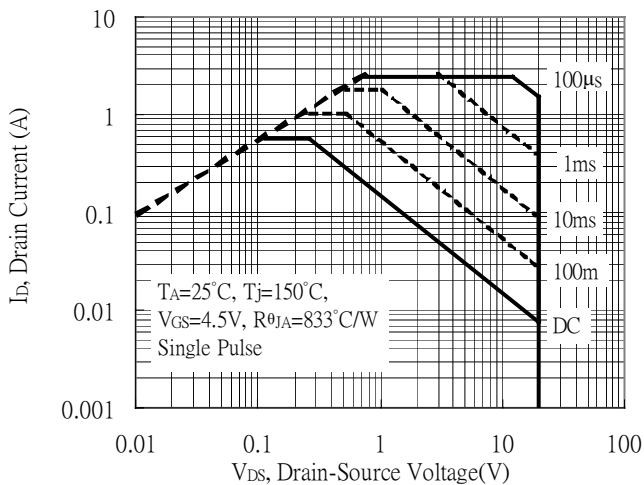

Maximum Drain Current vs Junction Temperature

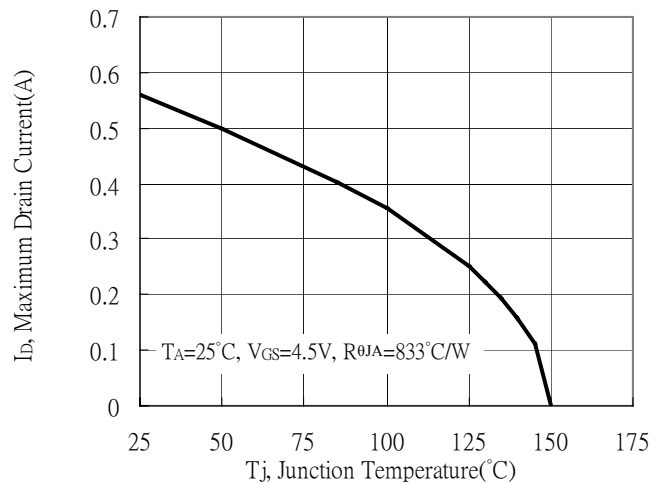

**Typical Characteristics(Cont.)**

Typical Transfer Characteristics

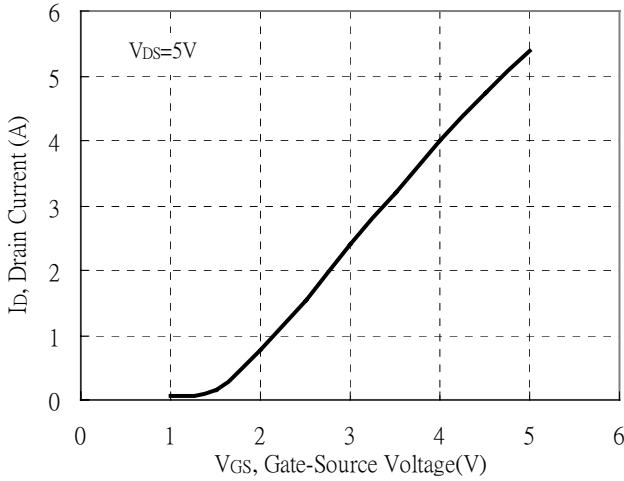

Power Derating Curve

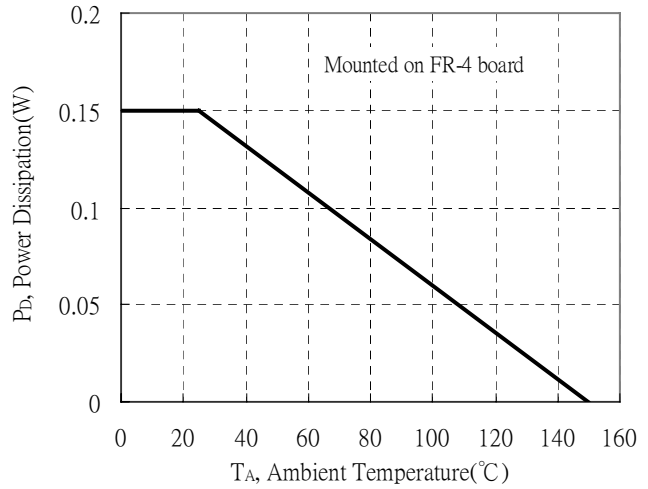

Forward Transfer Admittance vs Drain Current

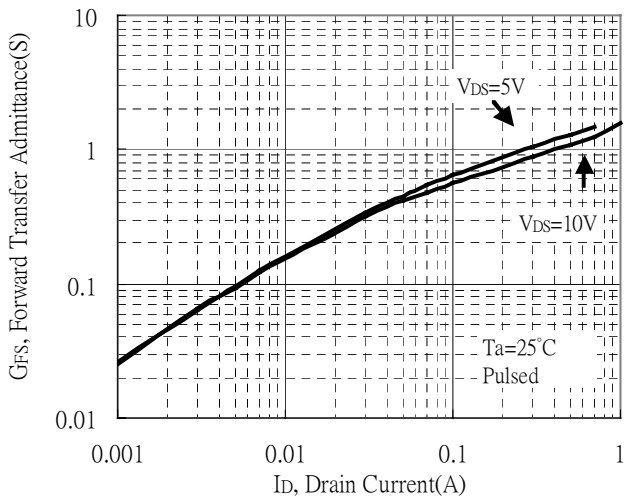

Transient Thermal Response Curves

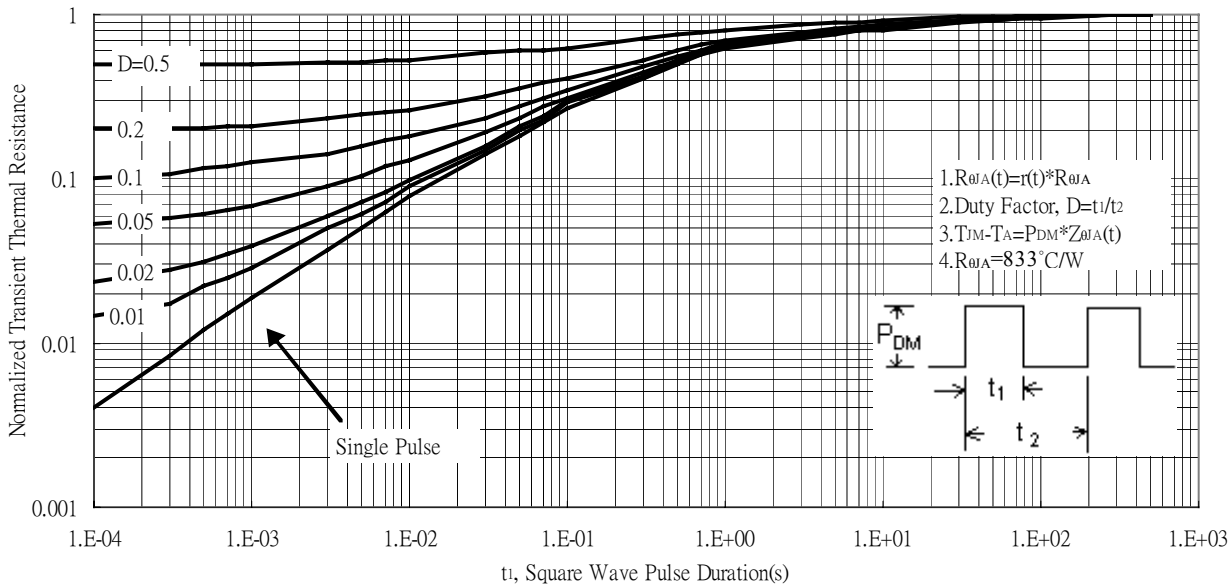

**Reel Dimension**

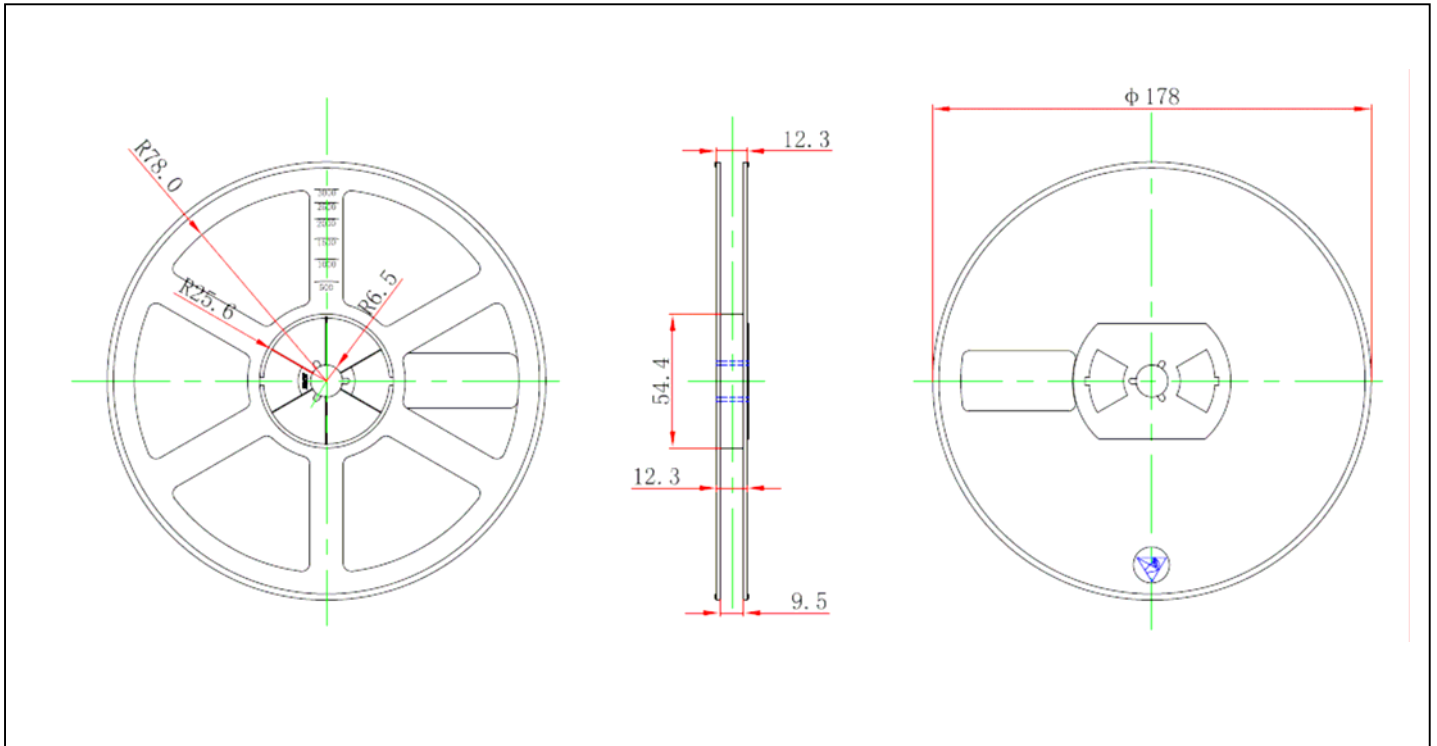

**Carrier Tape Dimension**

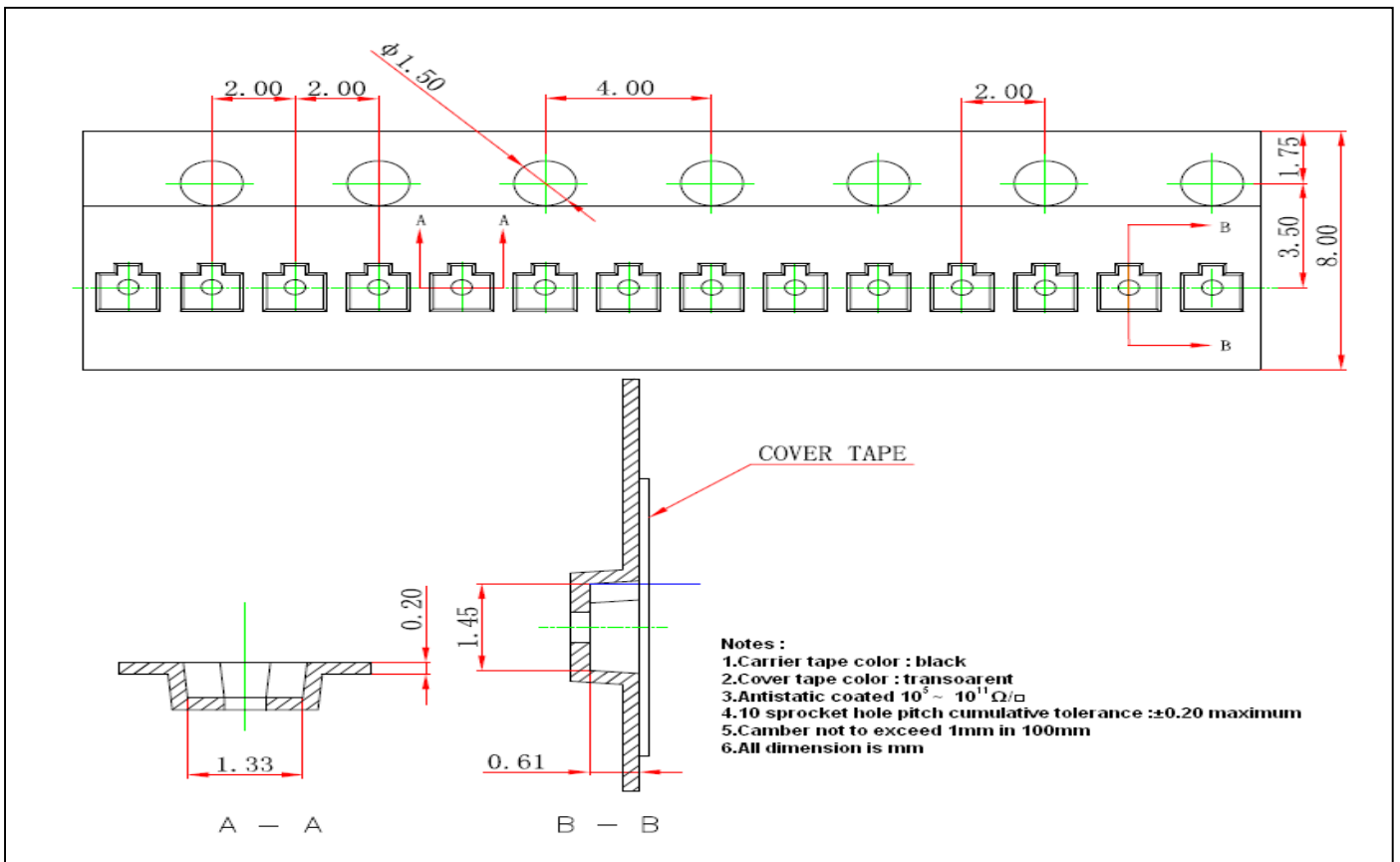

- Notes :**
1. Carrier tape color : black
  2. Cover tape color : translucent
  3. Antistatic coated  $10^5 - 10^{11} \Omega/\square$
  4. 10 sprocket hole pitch cumulative tolerance :  $\pm 0.20$  maximum
  5. Camber not to exceed 1mm in 100mm
  6. All dimension is mm

**Recommended wave soldering condition**

Product	Peak Temperature	Soldering Time
Pb-free devices	260 +0/-5 °C	5 +1/-1 seconds

**Recommended temperature profile for IR reflow**

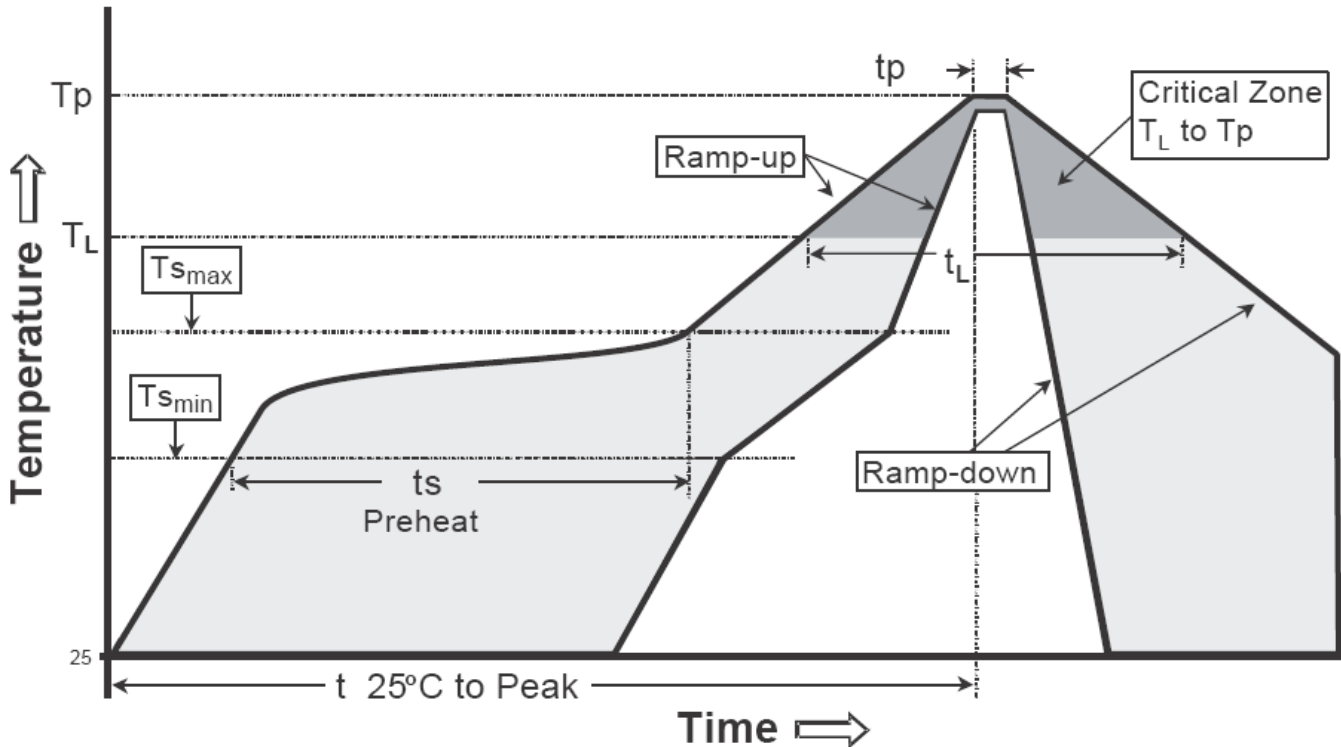

Profile feature	Sn-Pb eutectic Assembly	Pb-free Assembly
Average ramp-up rate (Tsmax to Tp)	3°C/second max.	3°C/second max.
Preheat -Temperature Min(Ts min) -Temperature Max(Ts max) -Time(ts min to ts max)	100°C 150°C 60-120 seconds	150°C 200°C 60-180 seconds
Time maintained above: -Temperature (TL) - Time (tL)	183°C 60-150 seconds	217°C 60-150 seconds
Peak Temperature(TP)	240 +0/-5 °C	260 +0/-5 °C
Time within 5°C of actual peak temperature(tp)	10-30 seconds	20-40 seconds
Ramp down rate	6°C/second max.	6°C/second max.
Time 25 °C to peak temperature	6 minutes max.	8 minutes max.

Note : All temperatures refer to topside of the package, measured on the package body surface.



**SOT-723 Dimension**

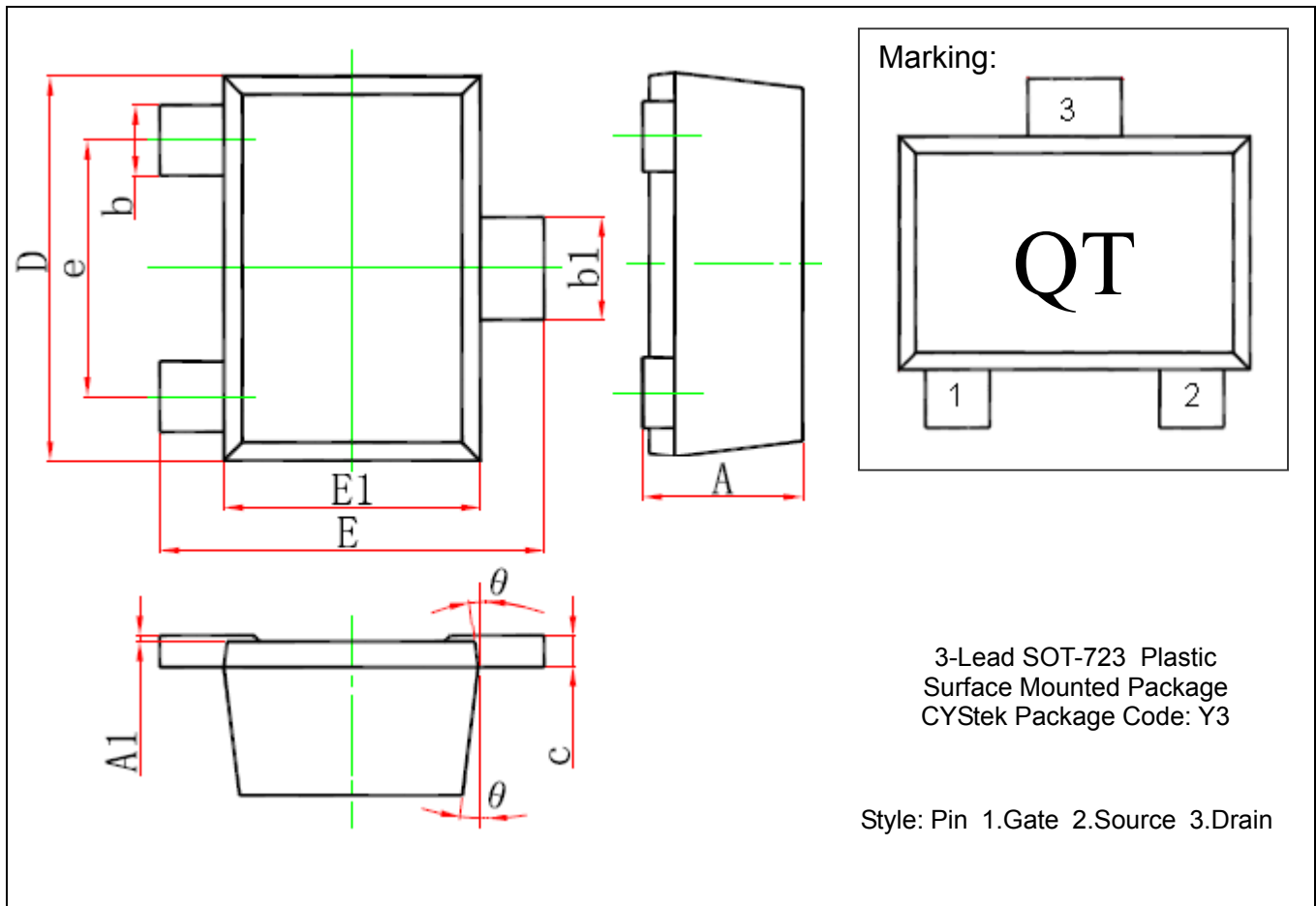

\*Typical

DIM	Millimeters		Inches		DIM	Millimeters		Inches	
	Min.	Max.	Min.	Max.		Min.	Max.	Min.	Max.
A	0.000	0.500	0.000	0.020	D	1.150	1.250	0.045	0.049
A1	0.000	0.050	0.000	0.002	E	1.150	1.250	0.045	0.049
b	0.170	0.270	0.007	0.011	E1	0.750	0.850	0.030	0.033
b1	0.270	0.370	0.011	0.015	e	0.800*		0.031*	
c	0.000	0.150	0.000	0.006	θ	7° REF		7° REF	

- Notes:**
- 1.Controlling dimension: millimeters.
  - 2.Maximum lead thickness includes lead finish thickness, and minimum lead thickness is the minimum thickness of base material.
  - 3.If there is any question with packing specification or packing method, please contact your local CYStek sales office.

**Material:**

- Lead: Pure tin plated.
- Mold Compound: Epoxy resin family, flammability solid burning class: UL94V-0.

**Important Notice:**

- All rights are reserved. Reproduction in whole or in part is prohibited without the prior written approval of CYStek.
- CYStek reserves the right to make changes to its products without notice.
- CYStek **semiconductor products are not warranted to be suitable for use in Life-Support Applications, or systems.**
- CYStek assumes no liability for any consequence of customer product design, infringement of patents, or application assistance.

## X-ON Electronics

Largest Supplier of Electrical and Electronic Components

*Click to view similar products for [MOSFET](#) category:*

*Click to view products by [CYSTECH](#) manufacturer:*

Other Similar products are found below :

[614233C](#) [648584F](#) [MCH3443-TL-E](#) [MCH6422-TL-E](#) [FDPF9N50NZ](#) [FW216A-TL-2W](#) [FW231A-TL-E](#) [APT5010JVR](#) [NTNS3A92PZT5G](#)  
[IRF100S201](#) [JANTX2N5237](#) [2SK2464-TL-E](#) [2SK3818-DL-E](#) [FCA20N60\\_F109](#) [FDZ595PZ](#) [STD6600NT4G](#) [FSS804-TL-E](#) [2SJ277-DL-E](#)  
[2SK1691-DL-E](#) [2SK2545\(Q,T\)](#) [D2294UK](#) [405094E](#) [423220D](#) [MCH6646-TL-E](#) [TPCC8103,L1Q\(CM](#) [367-8430-0972-503](#) [VN1206L](#)  
[424134F](#) [026935X](#) [051075F](#) [SBVS138LT1G](#) [614234A](#) [715780A](#) [NTNS3166NZT5G](#) [751625C](#) [873612G](#) [IRF7380TRHR](#)  
[IPS70R2K0CEAKMA1](#) [RJK60S3DPP-E0#T2](#) [RJK60S5DPK-M0#T0](#) [APT5010JVFR](#) [APT12031JFLL](#) [APT12040JVR](#) [DMN3404LQ-7](#)  
[NTE6400](#) [JANTX2N6796U](#) [JANTX2N6784U](#) [JANTXV2N5416U4](#) [SQM110N05-06L-GE3](#) [SIHF35N60E-GE3](#)