

Features:

- RoHS compliant
- Long operating life
- Ideal for backlight and indicator
- Various Colors brightness Available
- Moisture sensitivity level: 3

Application:

- Backlight
- Decoration lighting
- motormeter
- Indicator



Part Number	Dice Material	Emitted Color	Lens Color
E6C1204CWAY1UDA	InGaN	White	Yellow Diffused

Electro-Optical Characteristics (T_a=25°C, @20mA)

Parameter	Symbol	Min.	Typ.	Max.	Unit
Luminous Intensity	IV	400	-	1000	mcd
Radiation Bandwidth	Δλ	-	-	-	nm
Forward Voltage	V _F	2.90	3.00	3.40	v
Luminous Flux	Φ	-	-	-	Lm
Dominant Wavelength	λ _d	-	-	-	nm
CIE Coordinates CIE	x,y	-	0.27,0.28	-	-
Color Temperature	T _c	-	-	-	k
Viewing Angle	2θ _{1/2}	-	120	-	deg
Reverse Current	I _R	-	-	10	uA

Absolute Maximum Ratings (T_a=25°C)

Parameter	Symbol	Max.	Unit
Peak Forward Current(1/10 Duty Cycle, 0.1ms Pulse Width)	IPF	100	mA
Forward Current	IF	30	mA
Reverse Voltage	VR	5	v
Electrostatic Discharge	ESD	2000	v
Operating Temperature Range	Topr	-40to+90	°C
Storage Temperature Range	Tstg	-40to+90	°C
Reflow Soldering	Tsld	260°C for 10secs	



Optical & Electrical Characteristics

Spectrum Distribution

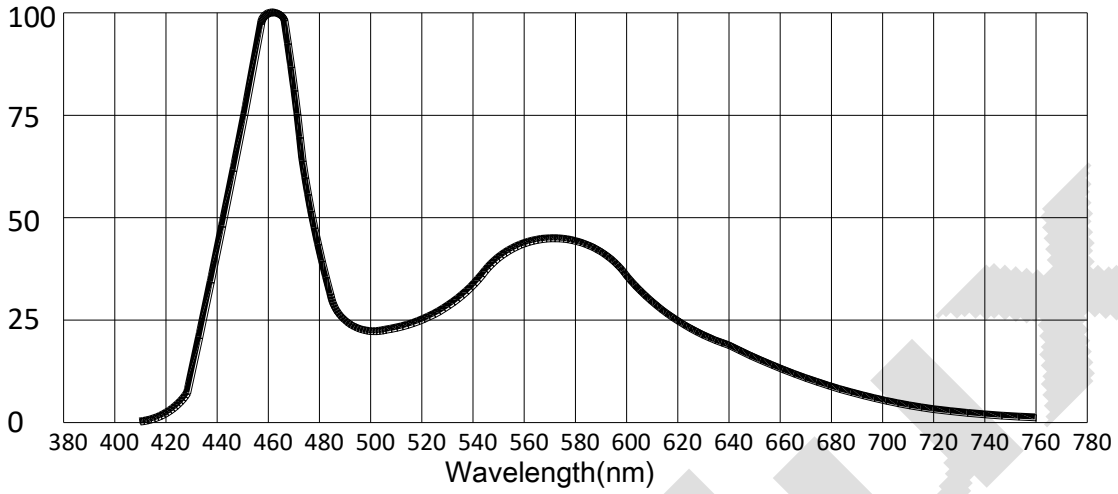

Forward Current vs. Forward Voltage

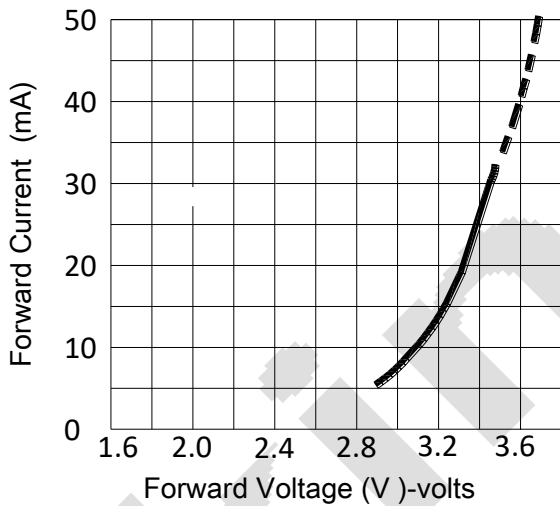

Forward Current vs. Ambient Temperature

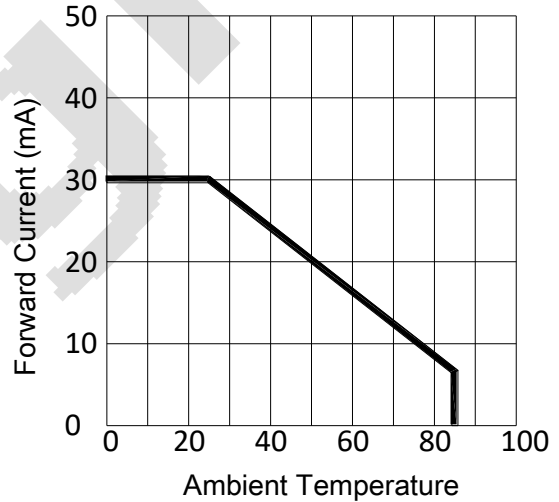

Relative Luminous Intensity vs. Forward Current

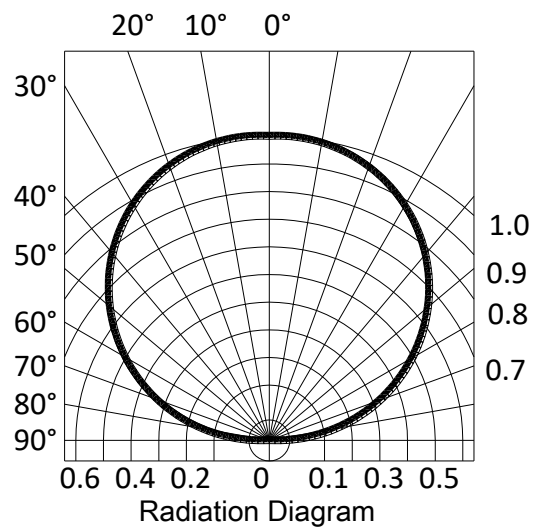
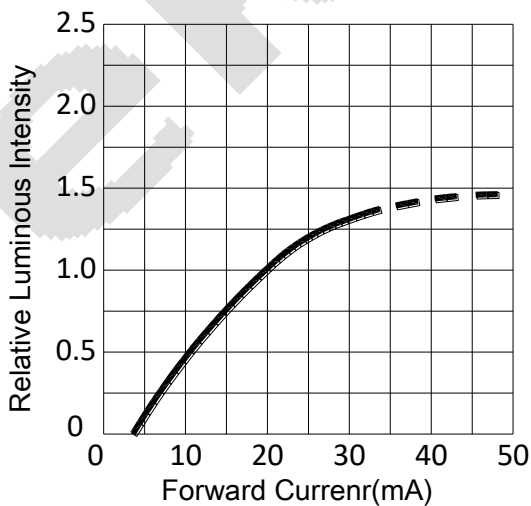



Bin Limits

Bin Range Of Luminous Intensity (Unit:mcd)

Bin Code	Min	Max	Condition
L1	400	600	IF=20mA
L2	600	800	
L3	800	1000	

Bin Range Of Forward Voltage (Unit:V)

Bin Code	Min	Max	Condition
V1	2.9	3.0	IF=20mA
V2	3.0	3.1	
V3	3.1	3.2	
V4	3.2	3.3	
V5	3.3	3.4	

Notes:

- 1.Tolerance of Luminous Intensity $\pm 10\%$
- 2.Tolerance of Forward Voltage $\pm 0.1V$



Color Bin Limits

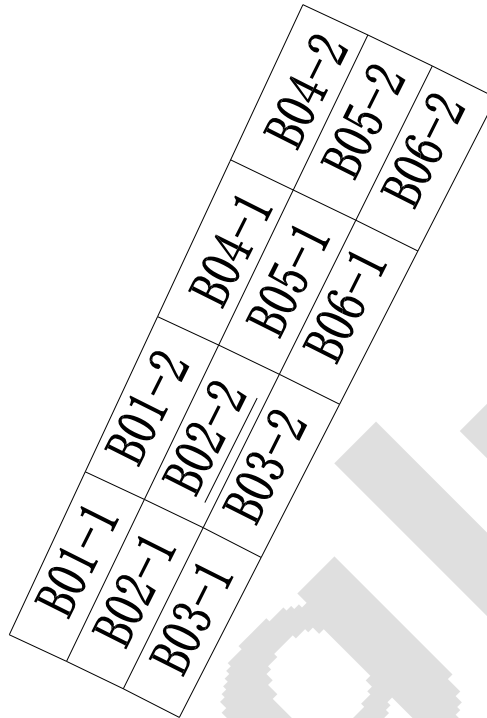

BIN	X1	Y1	X2	Y2	X3	Y3	X4	Y4
B01-1	0.2699	0.2697	0.2668	0.2711	0.2709	0.2798	0.2740	0.2783
B01-2	0.2740	0.2783	0.2709	0.2798	0.2747	0.2881	0.2780	0.2866
B02-1	0.2729	0.2682	0.2699	0.2697	0.2740	0.2783	0.2772	0.2768
B02-2	0.2772	0.2768	0.2740	0.2783	0.2780	0.2866	0.2812	0.2850
B03-1	0.2759	0.2667	0.2729	0.2682	0.2772	0.2768	0.2803	0.2752
B03-2	0.2803	0.2752	0.2772	0.2768	0.2812	0.2850	0.2845	0.2834
B04-1	0.2780	0.2866	0.2747	0.2881	0.2786	0.2964	0.2820	0.2948
B04-2	0.2820	0.2948	0.2786	0.2964	0.2825	0.3047	0.2860	0.3031
B05-1	0.2812	0.2850	0.2780	0.2866	0.2820	0.2948	0.2853	0.2932
B05-2	0.2853	0.2932	0.2820	0.2948	0.2860	0.3031	0.2894	0.3015
B06-1	0.2845	0.2834	0.2812	0.2850	0.2853	0.2932	0.2886	0.2916
B06-2	0.2886	0.2916	0.2853	0.2932	0.2894	0.3015	0.2928	0.2998

Reliability Test Items And Conditions

Test Items	Reference	Test Conditions	Time	Quantity	Criterion
Thermal Shock	MIL-STD-202G	-40°C (30min) -100°C (30min)	100 Cycles	22	0/22
Temperature And Humidity Cyclic	JEITA ED-4701 200 203	-10°C~65°C ; 0%~90%RH	10cycles	22	0/22
High Temperature Storage	JEITA ED -4071 200 201	Ta=100°C	1000H	22	0/22
Low Temperature Storage	JEITA ED -4071 200 202	Ta=-40°C	1000H	22	0/22
High Temperature High Humidity Storage	JEITA ED -4071 100 103	Ta=60°C ; RH=90%	1000H	22	0/22
High Temperature Life Test	JESD22-A108D	Ta=80°C	1000H	22	0/22
Life Test	JESD22-A108D	Ta=25°C IF=20mA	1000H	22	0/22
Resistance to Soldering Heat	GB/T 4937, II , 2.2&2.3	Tsol*=(240±5) °C 10secs	2 times	22	0/22

Criteria For Judging Damage

Test Items	Symbol	Test Conditions	Criteria For Judging Damage
Forward Voltage	V _F	I _F =I _{FT}	Initial Data±10%
Reverse Current	I _R	V _R =5V	I _R ≤10uA
Luminous Intensity	I _V	I _F =I _{FT}	Average I _V degradation≤30% ; Single LED I _V degradation≤50%
Resistance to Soldering Heat	-	-	Material without internal cracks,no material between stripped,no dead light

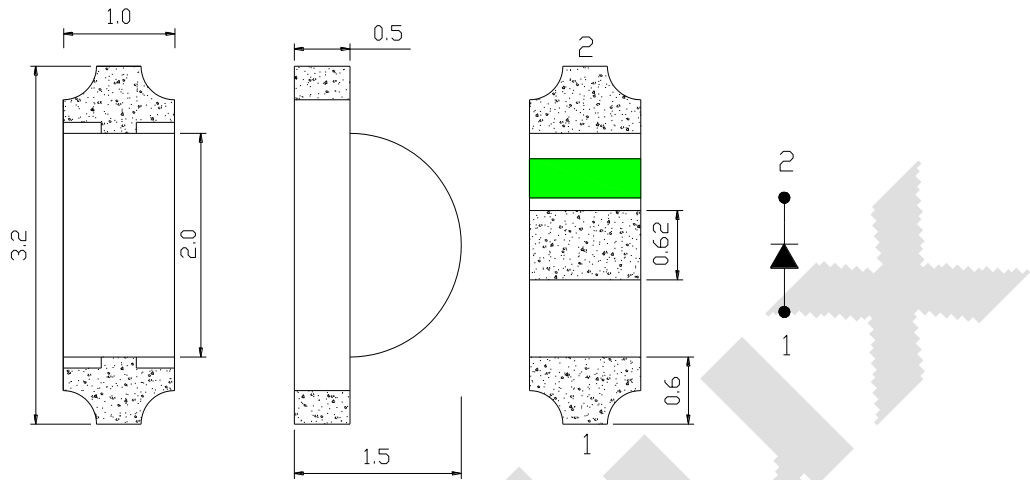
Product size (Unit:mm)

NOTES :

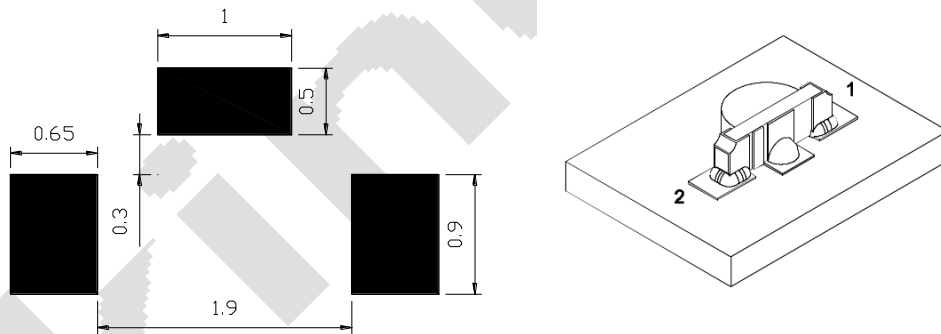
1. All dimensions are in millimeters (inches)
2. Tolerances are $\pm 0.2\text{mm}$ (0.008inch) unless otherwise noted

Recommended Soldering Pad Design (Unit:mm)

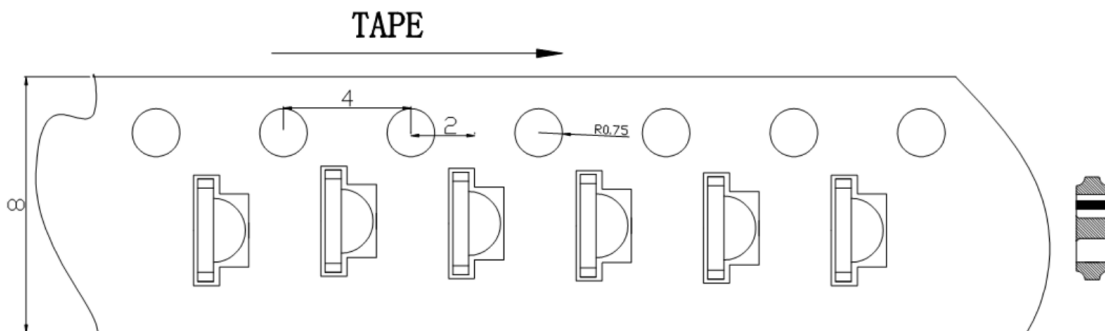
Taping and package Spec

- Tape Specification:3,000pcs Per Reel

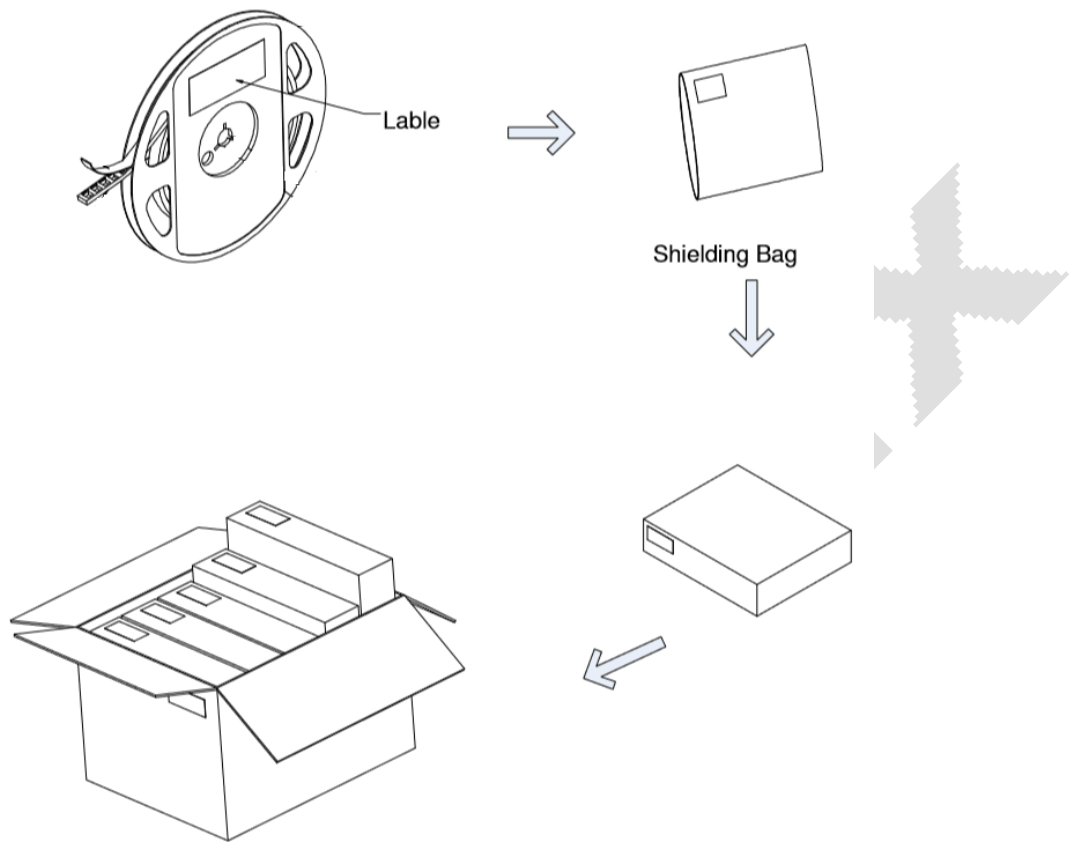

Packaging



LabelStyle

EKINGLUX OPTOELECTRONICS(SHANGHAI) CO.,LTD



P/N:E6C1206QBAC1UDA

Emitting Color: Blue

HUE: 466-468 nm

IV :100-150 mcd



VF: 3.0-3.2 V *example* BIN Code: 2

QTY: 3000 PCS DATE: 2018/06/06



LOT NO.:1806103





Useful hint

Reflow Soldering Instructions

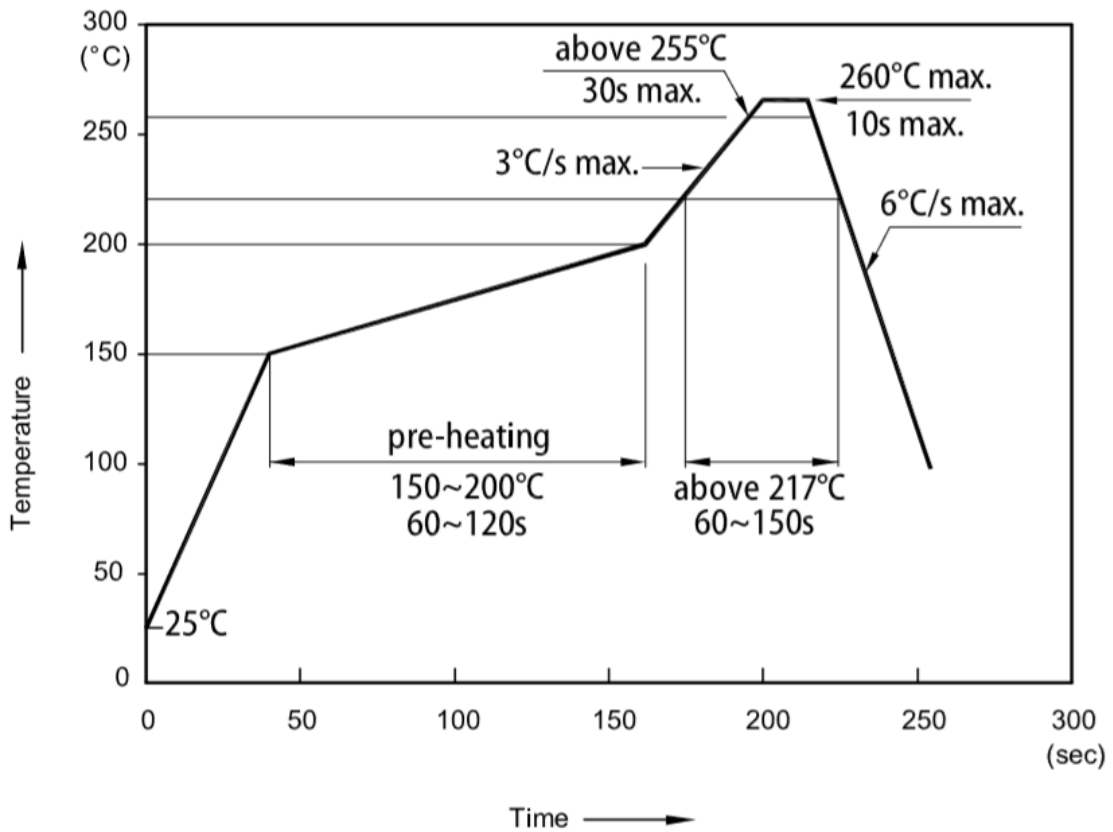

1. Don't cause stress to the LEDs while it is exposed to high temperature.
2. The maximum number of reflow soldering passes is 2 times.
3. Reflow soldering is recommended. Other soldering methods are not recommended as they might cause damage to the product.

Precautions

1. Storage:

- Moisture proof and anti-electrostatic package with moisture absorbent material is used, to keep moisture to a minimum.
- Before opening the package, the product should be kept at 30°C or less and humidity less than 60% RH, and be used within a year.
- After opening the package, the product should be stored at 30°C or less and humidity less than 10%RH, and be soldered within 24 hours (1day). It is recommended that the product be operated at the workshop condition of 30°C or less and humidity less than 60%RH.
- If the moisture absorbent material has faded away or the LEDs have exceeded the storage time, baking treatment should be performed based on the following condition: (70±5)°C for 24 hours.

2. Static Electricity:

Static electricity or surge voltage damages the LEDs. Damaged LEDs will show some unusual characteristics such as the forward voltage becoming lower, or the LEDs do not light at the low current, even not light.

All devices, equipment and machinery must be properly grounded. At the same time, it is recommended that wrist bands or anti-electrostatic gloves, anti-electrostatic containers be used when dealing with the LEDs.

3. Vulcanization:

LED curing is due to sulfur being in brackets and the +1 price of silver in the chemical reaction generated Ag₂S in the process. It will lead to the capacity of reflecting of silver layer reducing, light color temperature drift and serious decline, seriously affecting the performance of the product. So we should take corresponding measures to avoid vulcanization, such as to avoid using sulphur volatile substances and keeping away from high sulphur content of the material.

X-ON Electronics

Largest Supplier of Electrical and Electronic Components

Click to view similar products for [Standard LEDs - SMD category](#):

Click to view products by [EKINGLUX manufacturer](#):

Other Similar products are found below :

[LTST-C19GD2WT](#) [LTST-N683GBEW](#) [597-3006-607F](#) [597-3403-607F](#) [LTW-K140SZR40](#) [LTW-M140ZVS](#) [598-8110-100F](#) [598-8170-100F](#)
[598-8610-202F](#) [7012X7](#) [AAAF5060QBFSEEZGS](#) [12-22SURSYGC/S530-A3/E2/TR8](#) [1383SURT/S530-A3/TR1\(R\)](#) [APT1608QGW](#)
[EASV1803BA0](#) [SML310BATT86](#) [SML-512VWT86A](#) [SML-LX0606SISUGC/A](#) [SML-LXL1307SRC-TR](#) [SML-LXR851SIUPGUBC](#)
[LT1ED53A](#) [17-21/G6C-FM1N2B/3T](#) [FAT801-S](#) [SSL-LXA227IC-TR31A](#) [AM27ZGC03](#) [APB3025SGNC](#) [APHK1608VGCA](#) [APT2012QGW](#)
[CLMVC-FKA-CA1E1L81BB7C3C3](#) [CLYBA-FKA-CFHHL9BBB7A363](#) [CMD11504UR](#) [LTW-020ZDCG](#) [LTW-21TS5](#) [LTW-K140SZR30](#)
[HSMY-C177](#) [HT-121UYG-4739](#) [UYGT801-S](#) [KVH1C100MF6R](#) [42-21SYGC/S530-E1/TR8](#) [YGFR411-H](#) [597-2311-402F](#) [597-2712-602F](#)
[5973212407NF](#) [597-3302-607F](#) [597-5202-407F](#) [598-8330-117F](#) [SAW8WA2A-L35M40-CA](#) [SML013WBDW1](#) [SML522BUWT86](#) [SML-](#)
[LX0402IC-TR](#)