

XKB

SWITCH CONNECTOR

	MATERIAL	PLATING
center pin	brass	nickel
terminal 1	brass	silver
terminal 2	phosphor bronze	silver
terminal 3	brass	silver
bushing	brass	nickel
nut	brass	nickel
washer	steel	nickel
insulator	red vulcanized fiber	
plastic	PBT	

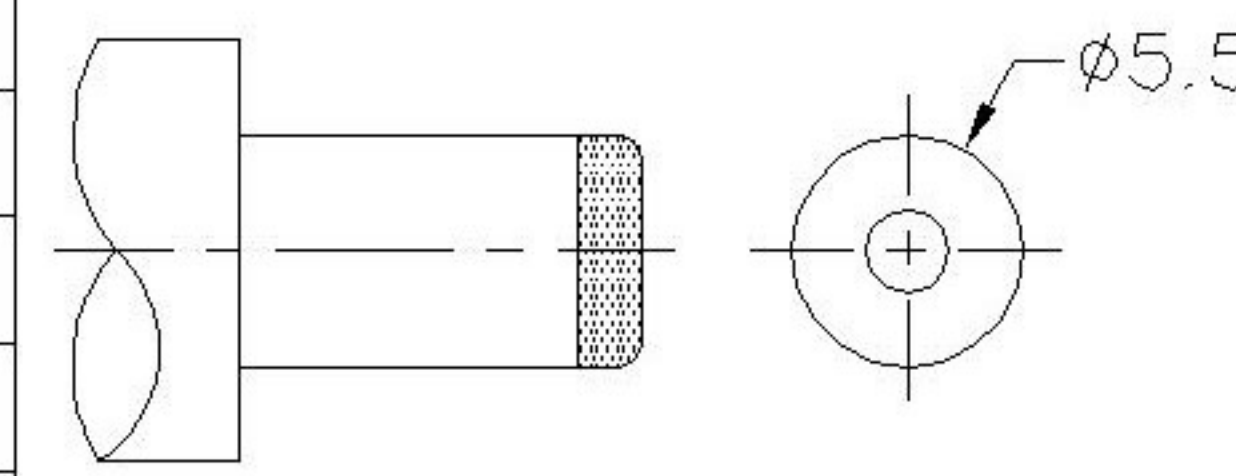

MATING PLUG
Jack Insertion Depth: 9.0 mm

SCHEMATIC	
Model	DC-025
Center Pin	Ø2.0 mm
	Ø2.5 mm

△ X	DESCRIPTION	DATE	REVISED	APPROVED	ANGULAR	±ε
△ X					L ≤ 4	±L/2
△ X					4 < L ≤ 16	±0.1
MAPK					16 < L ≤ 63	±0.4
					L > 63	±0.5

DSND		DATE		SCALE: N/A	MODEL T/FE:
DWN		DATE		VIEW:	DC POWER JACK
CHKD		DATE		UNIT: mm	FART NO.:
APPD		DATE		SIZE: A4	DWG NO.:
XKB INDUSTRIAL PRECISION CO., LIMITED					DC-025-5A-2.5
	WEIGHT	SHEET	REVISION		
	1.0g	1/1	A0		

X-ON Electronics

Largest Supplier of Electrical and Electronic Components

Click to view similar products for [DC Power Connectors](#) category:

Click to view products by [XKB](#) manufacturer:

Other Similar products are found below :

[1600206-1](#) [163-0301-EX](#) [163-0302](#) [163-0308-EX](#) [163-0310-EX](#) [163-1061-EX](#) [163-1100-EX](#) [163-4024](#) [163-4117-EX](#) [163-4118-EX](#) [163-5005-E](#) [163-7421](#) [163-MJ22-EX](#) [171-0721-EX](#) [171-0725-EX](#) [171-3118-EX](#) [171-3210-E](#) [171-3221-EX](#) [171-3222-EX](#) [171-A1326-EX](#) [173-23507-ST-EX](#) [173-5521TIP-EX](#) [173-6330TIP-EX](#) [KLDVX-SMT-02-ATR](#) [KLDX-0201-AHT-1](#) [KLDX-0202-AHT](#) [KLDX-SMT-0202-BP](#) [KLDX-SMT-0202-BPTR](#) [163-0179-EX](#) [163-0307-E](#) [163-0309-EX](#) [163-4007-EX](#) [163-4015-EX](#) [163-4025](#) [163-4119-E](#) [163-4303-E](#) [16PJ101-EX](#) [171-0702-EX](#) [171-0722-E](#) [171-0726-EX](#) [171-2122-EX](#) [171-3216-EX](#) [171-3218-EX](#) [171-3219-EX](#) [171-3220-EX](#) [171-7391](#) [173-3413-ST-EX](#) [173-4017-ST-EX](#) [RAPCBRK](#) [K596](#)