

Ultra-Low-Noise, High PSRR, Low-Dropout, 300mA Linear Regulator

Features

- **Wide Operating Voltage: 2.5~6V**
- **Low Dropout Voltage: 290mV @ 3V/300mA**
- **Guaranteed 300mA Output Current**
- **High PSRR: 70dB**
- **Current-Limit Protection**
- **Controlled Short-Circuit Current: 50mA**
- **Over-Temperature Protection**
- **Stable with 1mF Capacitor for Any Load**
- **Excellent Load/Line Transient**
- **SOT-23-5, TSOT-23-5, SOT-23-3, SC-70-5, SC-82-4, TDFN1.5x1.5-6 and TDFN1.6x1.6-6 Packages**
- **Lead Free and Green Devices Available (RoHS Compliant)**

General Description

The APL5320/A is a P-channel low dropout linear regulator which needs only one input voltage from 2.5 to 6V, and delivers current up to 300mA to set output voltage. It also can work with low ESR ceramic capacitors and is ideal for using in the battery-powered applications such as notebook computers and cellular phones. Typical dropout voltage is only 290mV at 300mA loading.

The APL5320/A provides several versions of fixed output voltages ranging. Current-limit with current foldback and thermal shutdown functions protects the device against current over-loads and over-temperature. The APL5320/A is available in SOT-23-5, TSOT-23-5, SOT-23-3, SC-70-5, SC-82-4, TDFN1.5x1.5-6 and TDFN 1.6x1.6-6 packages.

Applications

- **Cellular Phones**
- **Portable and Battery-Powered Equipments**
- **Laptops, Palmtops, Notebook Computers**
- **Wireless LANs**
- **Portable Information Appliances**
- **GPSes**

Simplified Application Circuit

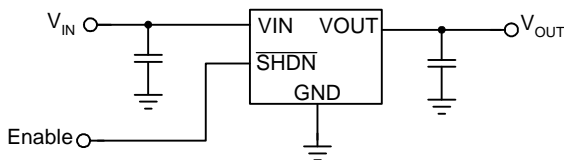

Pin Configuration

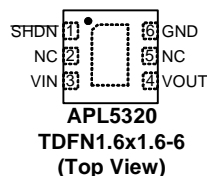
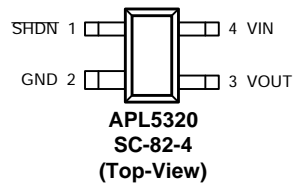
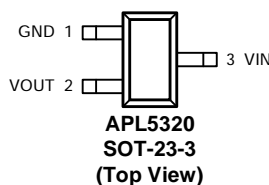
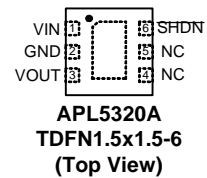
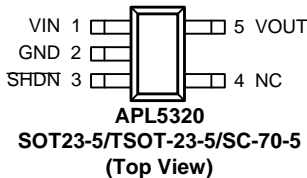

 = Exposed Pad (connected to ground plane for better heat dissipation)

ANPEC reserves the right to make changes to improve reliability or manufacturability without notice, and advise customers to obtain the latest version of relevant information to verify before placing orders.

Ordering and Marking Information

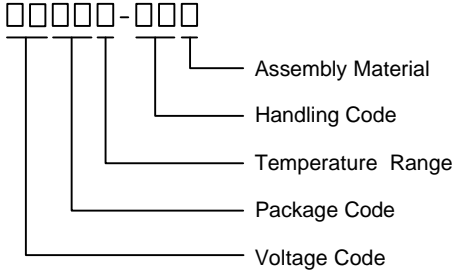
<p>APL5320/A □□□□-□□□</p> 	<p>Package Code B : SOT-23-5 BT : TSOT-23-5 A : SOT-23-3 SR : SC-82-4 S5 : SC-70-5 QB : TDFN1.6x1.6-6 QB : TDFN1.5x1.5-6 (only for APL5320A) Operating Ambient Temperature Range I : -40 to 85 °C Handling Code TR : Tape & Reel Voltage Code 12 : 1.2V Assembly Material G : Halogen and Lead Free Device</p>
--	---

Note : ANPEC lead-free products contain molding compounds/die attach materials and 100% matte tin plate termination finish; which are fully compliant with RoHS. ANPEC lead-free products meet or exceed the lead-free requirements of IPC/JEDEC J-STD-020D for MSL classification at lead-free peak reflow temperature. ANPEC defines "Green" to mean lead-free (RoHS compliant) and halogen free (Br or Cl does not exceed 900ppm by weight in homogeneous material and total of Br and Cl does not exceed 1500ppm by weight).

SOT-23-5

Product Name	Marking
APL5320-12B	205X
APL5320-15B	209X
APL5320-18B	20CX
APL5320-20B	20EX
APL5320-25B	20JX
APL5320-28B	20MX
APL5320-30B	20OX
APL5320-33B	20RX

Note: X - Code.

SOT-23-3

Product Name	Marking
APL5320-12A	205X
APL5320-15A	209X
APL5320-18A	20CX
APL5320-20A	20EX
APL5320-25A	20JX
APL5320-28A	20MX
APL5320-30A	20OX
APL5320-33A	20RX

Note: X - Code.

SC-70-5

Product Name	Marking
APL5320-12S5	205
APL5320-15S5	209
APL5320-18S5	20C
APL5320-20S5	20E
APL5320-25S5	20J
APL5320-28S5	20M
APL5320-30S5	20O
APL5320-33S5	20R

TSOT-23-5

Product Name	Marking
APL5320-12BT	205X
APL5320-15BT	209X
APL5320-18BT	20CX
APL5320-20BT	20EX
APL5320-25BT	20JX
APL5320-28BT	20MX
APL5320-30BT	20OX
APL5320-33BT	20RX

Note: X - Code.

TDFN1.6x1.6-6 / TDFN1.5x1.5-6

Product Name	Marking
APL5320-12QB	205X
APL5320-15QB	209X
APL5320-18QB	20CX
APL5320-20QB	20EX
APL5320-25QB	20JX
APL5320-28QB	20MX
APL5320-30QB	20OX
APL5320-33QB	20RX

Note: X - Code.

SC-82-4

Product Name	Marking
APL5320-12SR	205
APL5320-15SR	209
APL5320-18SR	20C
APL5320-20SR	20E
APL5320-25SR	20J
APL5320-28SR	20M
APL5320-30SR	20O
APL5320-33SR	20R

Absolute Maximum Ratings (Note 1)

Symbol	Parameter	Rating	Unit
V_{IN}	VIN to GND Voltage	-0.3 ~ 6.5	V
V_{OUT}	VOUT to GND Voltage	-0.3 ~ 6.5	V
$V_{\overline{SHDN}}$	\overline{SHDN} to GND Voltage	-0.3 ~ 6.5	V
T_J	Maximum Junction Temperature	-40 ~ 150	°C
T_{STG}	Storage Temperature	-65 ~ 150	°C
T_{SDR}	Maximum Lead Soldering Temperature, 10 Seconds	260	°C

Note1: Stresses beyond those listed under "absolute maximum ratings" may cause permanent damage to the device. These are stress ratings only and functional operation of the device at these or any other conditions beyond those indicated under "recommended operating conditions" is not implied. Exposure to absolute maximum rating conditions for extended periods may affect device reliability.

Thermal Characteristics

Symbol	Parameter	Typical Value	Unit
θ_{JA}	Junction-to-Ambient Resistance in Free Air ^(Note 2)	SOT-23-5	240
		TSOT-23-5	250
		SOT-23-3	240
		SC-70-5/SC-82-4	325
		TDFN1.6x1.6-6	165
		TDFN1.5x1.5-6	180
θ_{JC}	Junction-to-Case Resistance in Free Air	SOT-23-5	120
		TSOT-23-5	130
		SOT-23-3	120
		SC-70-5/SC-82-4	220

Note 2 : θ_{JA} is measured with the component mounted on a high effective thermal conductivity test board in free air.

Recommended Operating Conditions (Note 3)

Symbol	Parameter	Range	Unit
V_{IN}	VIN Input Voltage	2.5 ~ 6	V
$V_{\overline{SHDN}}$	\overline{SHDN} Input Voltage	2.5 ~ 6	V
I_{OUT}	VOUT Output Current	0 ~300	mA
V_{OUT}	Output Voltage	Fixed Voltage	
C_{OUT}	Output Capacitor	1~22	μF
T_A	Ambient Temperature	-40 ~ 85	°C
T_J	Junction Temperature	-40 ~ 125	°C

Note 3 : Refer to the typical application circuit.

Electrical Characteristics

Unless otherwise specified, these specifications apply over $V_{IN}=V_{OUT}+1V$, $C_{IN}=C_{OUT}=1\mu F$ and $T_A=-40\sim 85^\circ C$. Typical values are at $T_A=25^\circ C$.

Symbol	Parameter	Test Conditions	APL5320/A			Unit	
			Min.	Typ.	Max.		
UNDER-VOLTAGE LOCKAGE (UVLO) AND SUPPLY CURRENT							
	VIN UVLO Threshold Voltage	V_{IN} rising, $T_A=-40\sim 85^\circ C$	1.9	2.2	2.4	V	
	VIN UVLO Hysteresis		-	0.1	-	V	
I_Q	Quiescent Current	$I_{OUT}=0mA$, $V_{SHDN}=5V$	-	40	60	μA	
		$I_{OUT}=300mA$, $V_{SHDN}=5V$	-	40	60	μA	
I_{QSHDN}	Shut Down Supply Current	$V_{SHDN}=0V$, $V_{IN}=V_{OUT}+1V$	-	-	1	μA	
OUTPUT VOLTAGE							
	Output Voltage Accuracy	$I_{OUT}=1mA$, $T_A=25^\circ C$	-2	-	2	%	
		$I_{OUT}=1mA$ to $300mA$, $T_A=-40\sim 85^\circ C$	-3	-	3	%	
REG _{LINE}	Line Regulation	$\Delta V_{OUT}\% / \Delta V_{IN}$, $V_{OUT}+0.3V < V_{IN} < 6V$, $I_{OUT}=1mA$	-	-	0.2	%/V	
REG _{LOAD}	Load Regulation	$\Delta V_{OUT}\%$, $V_{IN}=V_{OUT}+1V$, $0mA < I_{OUT} < 300mA$	-	-	0.6	%	
V_{DROP}	Dropout Voltage	$V_{OUT}=1.5V$, $I_{OUT}=300mA$	-	0.52	0.68	V	
		$V_{OUT}=2V$, $I_{OUT}=300mA$	-	0.43	0.56	V	
		$V_{OUT}=3V$, $I_{OUT}=300mA$	-	0.29	0.38	V	
OUTPUT VOLTAGE							
PSRR	Ripple Rejection	$C_{OUT}=1\mu F$, $I_{OUT}=50mA$	f=1 kHz	-	70	-	dB
			f=10 kHz	-	63	-	dB
			f=100 kHz	-	35	-	dB
	Output Noise	f=10Hz to 100kHz, $C_{OUT}=10\mu F$, $I_{OUT}=1mA$	-	100	-	μV_{RMS}	
	VO _{UT} Discharge Resistance	$V_{SHDN}=0V$	-	0.7	-	k Ω	
SHUT DOWN							
V_{SHDN}	High Threshold Voltage	$V_{IN}=2.5$ to $6V$	1.5	-	-	V	
	Low Threshold Voltage	$V_{IN}=2.5$ to $6V$	-	-	0.4	V	
I_{SHDN}	SHDN Input Current	$V_{SHDN}=5V$	-	0.2	-	μA	
PROTECTIONS							
I_{LIMIT}	Current-Limit Threshold		330	450	750	mA	
I_{SHORT}	Short-Circuit Current	$V_{OUT}=0V$	-	50	-	mA	
t_{SS}	Soft-Start	V_{OUT} rising from 0 to 90%, $R_{LOAD}=50\Omega$, $T_A=25^\circ C$	-	60	100	μs	
T_{OTP}	Over-Temperature Threshold	T_J rising	-	160	-	$^\circ C$	
	Over-Temperature Hysteresis		-	40	-	$^\circ C$	

Typical Operating Characteristics

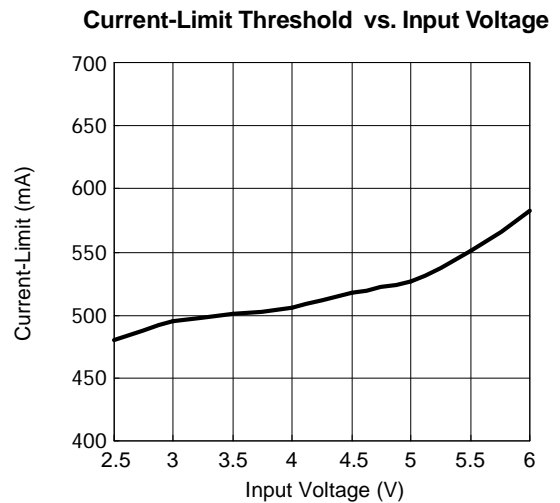
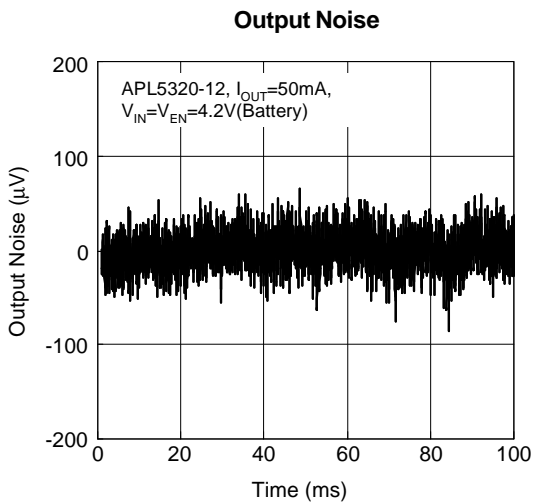
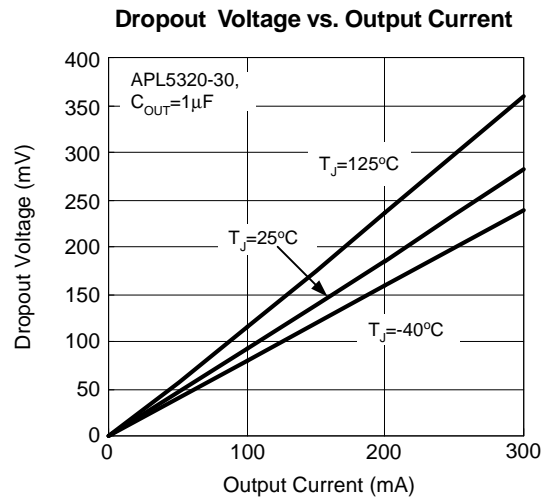
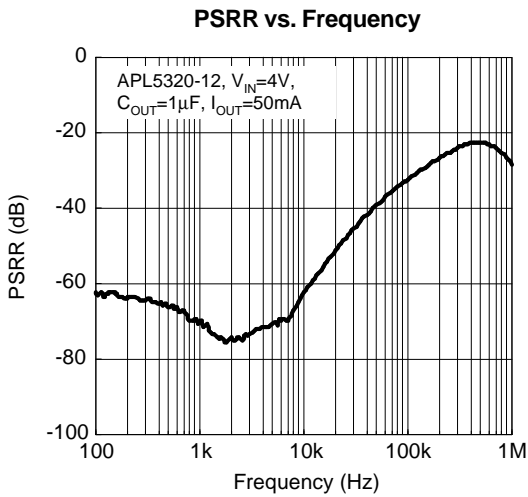
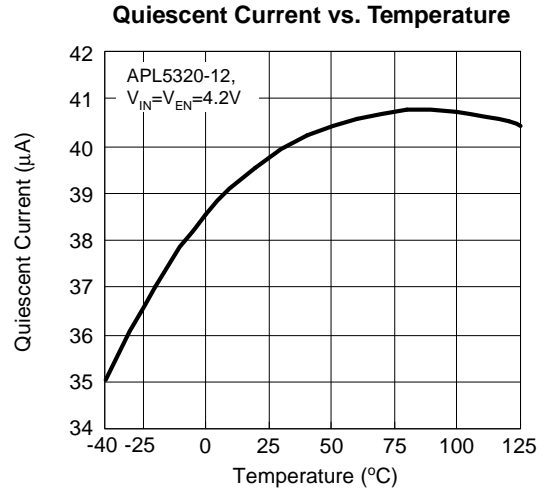
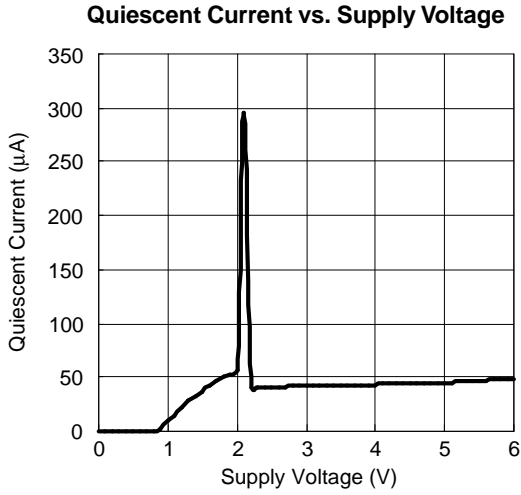

Typical Operating Characteristics (Cont.)

Current-Limit Threshold vs. Temperature

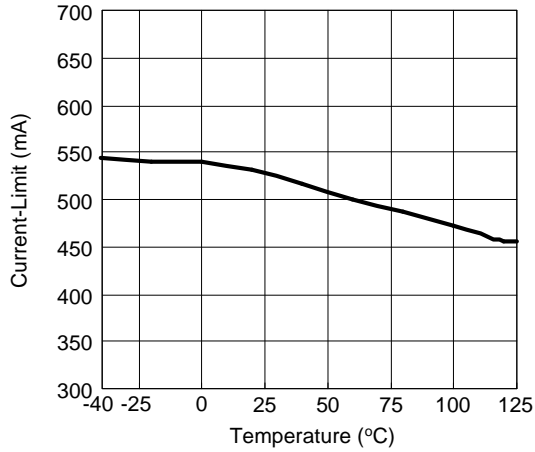

Quiescent Current vs. Output Current

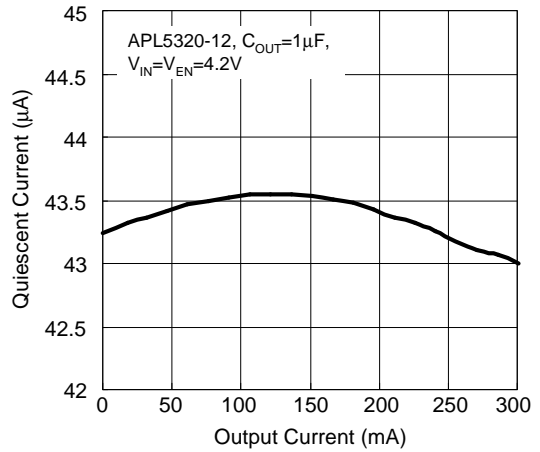

SHDN Pin Threshold Voltage vs. Supply Voltage

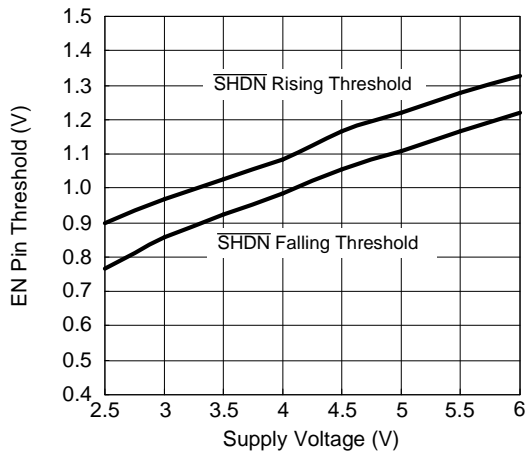

Operating Waveforms

The test condition is $V_{IN}=4.2V$, $T_A=25^{\circ}C$ unless otherwise specified.

Load Transient Response

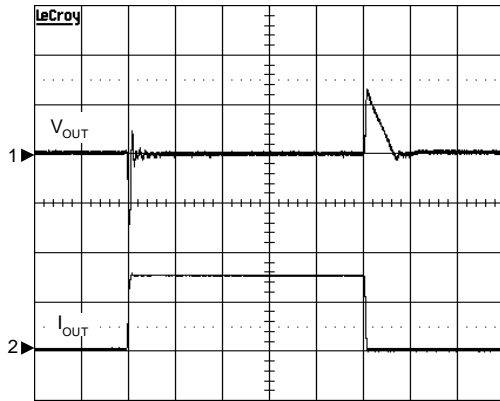

$V_{IN}=4.2V$, $V_{OUT}=1.2V$, $C_{IN}=C_{OUT}=1\mu F$,
 $I_{OUT}=10mA$ to $300mA$ to $10mA$ (Rise/Fall time= $1\mu s$)
 CH1: V_{OUT} , 50mV/Div, DC, Offset= $1.2V$
 CH2: I_{OUT} , 200mA/Div, DC
 TIME: 20 μs /Div

Load Transient Response

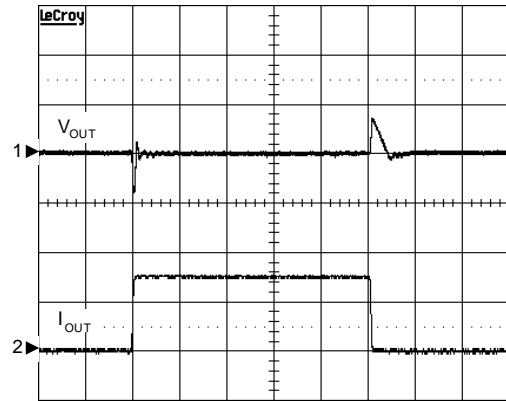

$V_{IN}=4.2V$, $V_{OUT}=1.2V$, $C_{IN}=C_{OUT}=1\mu F$,
 $I_{OUT}=10mA$ to $150mA$ to $10mA$ (Rise/Fall time= $1\mu s$)
 CH1: V_{OUT} , 50mV/Div, DC, Offset= $1.2V$
 CH2: I_{OUT} , 100mA/Div, DC
 TIME: 20 μs /Div

Load Transient Response

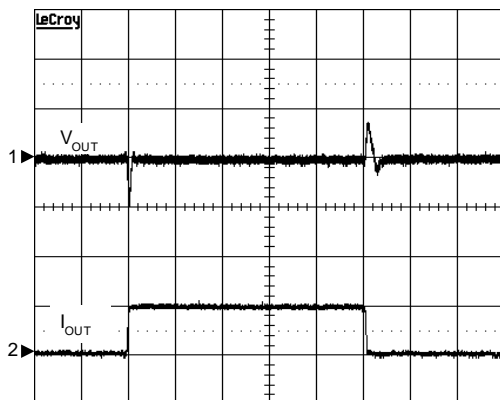

$V_{IN}=4.2V$, $V_{OUT}=1.2V$, $C_{IN}=C_{OUT}=1\mu F$,
 $I_{OUT}=10mA$ to $50mA$ to $10mA$ (Rise/Fall time= $1\mu s$)
 CH1: V_{OUT} , 20mV/Div, DC, Offset= $1.2V$
 CH2: I_{OUT} , 50mA/Div, DC
 TIME: 20 μs /Div

Line Transient Response

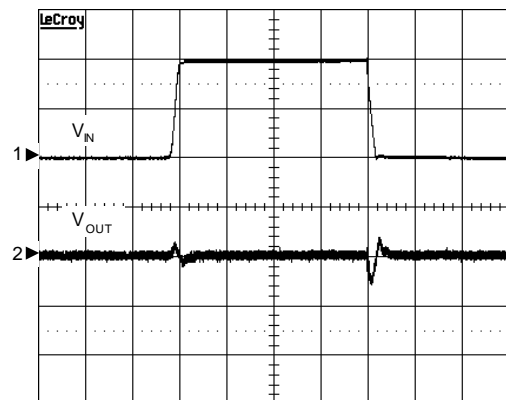

$V_{IN}=3.8V$ to $4.8V$ to $3.8V$ (Rise/Fall time= $4\mu s$),
 $V_{OUT}=1.2V$, $C_{IN}=C_{OUT}=1\mu F$, $I_{OUT}=100mA$
 CH1: V_{IN} , 500mV/Div, DC, Offset= $3.8V$
 CH2: V_{OUT} , 20mV/Div, DC, Offset= $1.2V$
 TIME: 20 μs /Div

Operating Waveforms (Cont.)

The test condition is $V_{IN}=4.2V$, $T_A=25^\circ C$ unless otherwise specified.

Line Transient Response

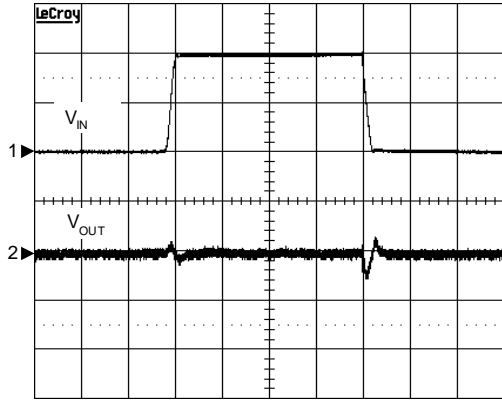

$V_{IN}=3.8V$ to $4.8V$ to $3.8V$ (Rise/Fall time= $4\mu s$),
 $V_{OUT}=1.2V$, $C_{IN}=C_{OUT}=1\mu F$, $I_{OUT}=50mA$
 CH1: V_{IN} , 500mV/Div, DC, Offset= $3.8V$
 CH2: V_{OUT} , 20mV/Div, DC, Offset= $1.2V$
 TIME: 20 μs /Div

Line Transient Response

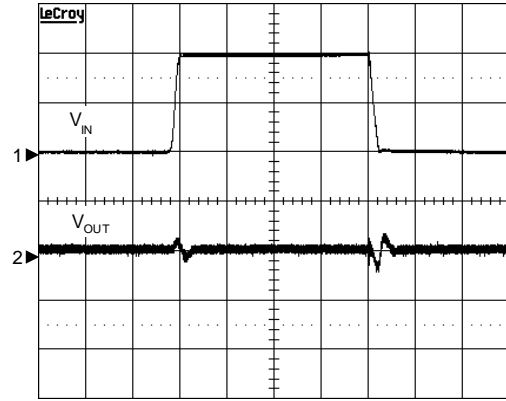

$V_{IN}=3.8V$ to $4.8V$ to $3.8V$ (Rise/Fall time= $4\mu s$),
 $V_{OUT}=1.2V$, $C_{IN}=C_{OUT}=1\mu F$, $I_{OUT}=10mA$
 CH1: V_{IN} , 500mV/Div, DC, Offset= $3.8V$
 CH2: V_{OUT} , 20mV/Div, DC, Offset= $1.2V$
 TIME: 20 μs /Div

Exiting Shutdown

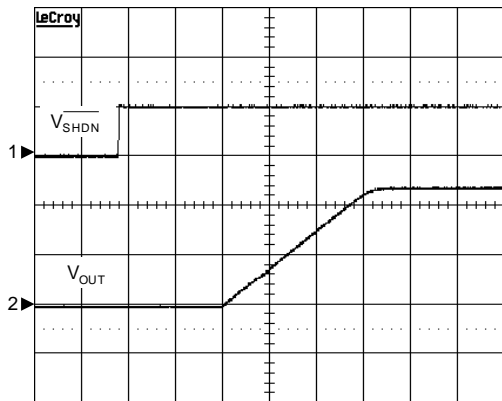

$V_{IN}=4.2V$, $V_{OUT}=1.2V$, $C_{IN}=C_{OUT}=1\mu F$,
 $I_{OUT}=10mA$
 CH1: V_{SHDN} , 2V/Div, DC
 CH2: V_{OUT} , 500mV/Div, DC
 TIME: 20 μs /Div

Entering Shutdown

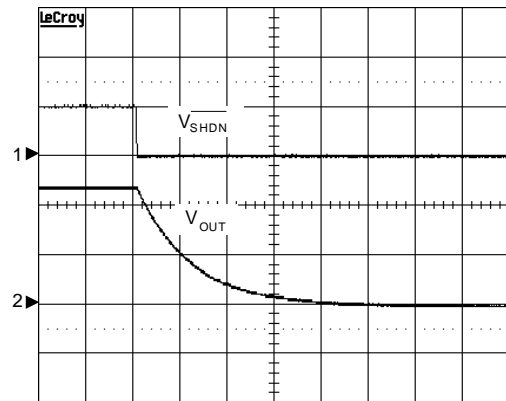

$V_{IN}=4.2V$, $V_{OUT}=1.2V$, $C_{IN}=C_{OUT}=1\mu F$,
 $I_{OUT}=10mA$
 CH1: V_{SHDN} , 2V/Div, DC
 CH2: V_{OUT} , 500mV/Div, DC
 TIME: 10 μs /Div

Pin Description

PIN NO.					NAME	FUNCTION
SOT-23-5/ TSOT-23-5/ SC-70-5	SOT-23-3	TDFN 1.6x1.6-6	SC-82-4	TDFN 1.5x1.5		
1	3	3	4	1	VIN	Voltage Supply Input Pin.
2	1	6	2	2	GND	Ground.
3	-	1	1	6	$\overline{\text{SHDN}}$	Shut Down Control Pin. Logic high: enable; logic low: shutdown. This pin can not be left floating.
4	-	2, 5	-	4,5	NC	NC Pin.
5	2	4	3	3	VOUT	Regulator Output Pin.

Block Diagram

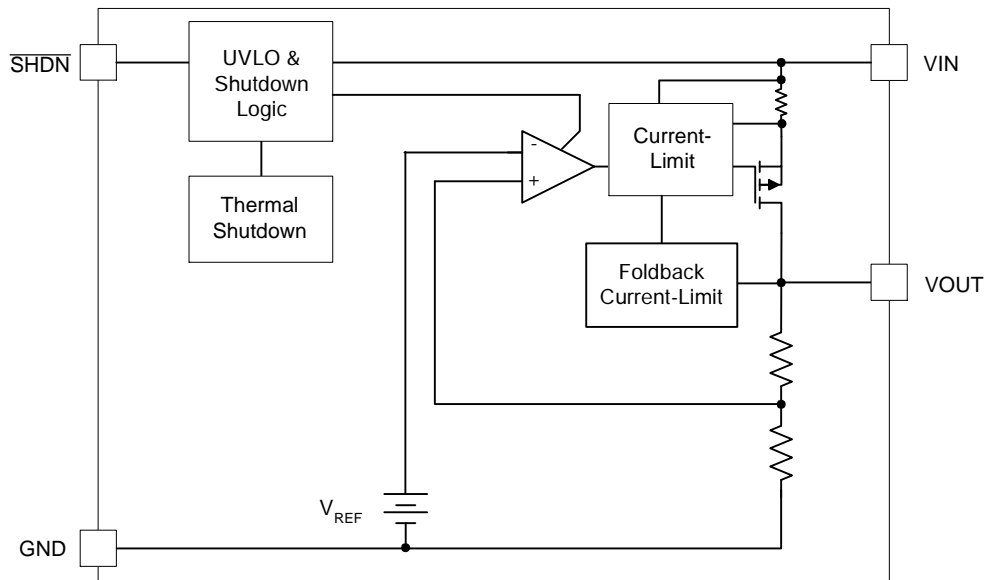

Typical Application Circuit

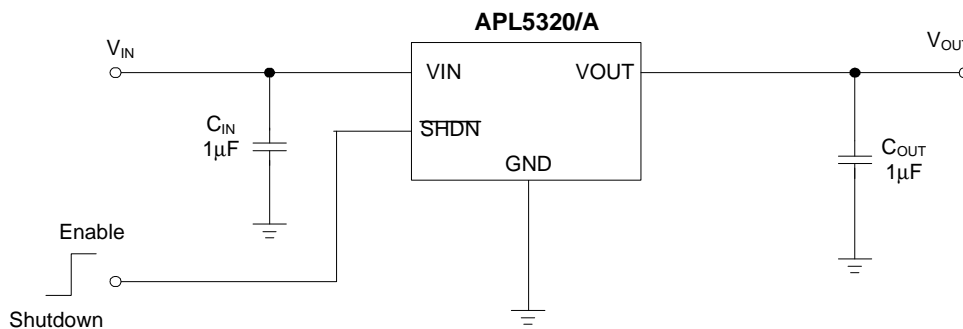

Function Description

Internal Soft-Start

An internal soft-start function controls rising rate of the output voltage to limit the surge current at start-up. The typical soft-start interval is about 60 μ s.

Thermal Shutdown

A thermal shutdown circuit limits the junction temperature of APL5320/A. When the junction temperature exceeds +160°C, a thermal sensor turns off the output PMOS, allowing the device to cool down. The regulator regulates the output again through initiation of a new soft-start cycle after the junction temperature cools by 40°C. The thermal shutdown is designed with a 40°C hysteresis to lower the average junction temperature during continuous thermal overload conditions, extending lifetime of the device.

For normal operation, device power dissipation should be externally limited so that junction temperature will not exceed 125°C.

Current-Limit with Current Foldback

The APL5320/A monitors the current via the output PMOS and limits the maximum current. When the output current reaches the current-limit threshold, current-limit with current foldback circuit starts to work to prevent load and APL5320/A from damages during overload or short-circuit conditions. Typical foldback current is about 50mA.

Shutdown Control

The APL5320/A has an active-low shutdown function. Forcing $\overline{\text{SHDN}}$ high (>1.5V) enables the V_{OUT} ; forcing $\overline{\text{SHDN}}$ low (<0.4V) disables the V_{OUT} . The $\overline{\text{SHDN}}$ can not be left floating. If it is not used, connect it to VIN for normal operation.

Under-Voltage Lock Out (UVLO)

The APL5320/A monitors the input voltage to prevent wrong logic control. The UVLO function initiates a soft-start process after input voltage exceeds its rising UVLO threshold during power on. The UVLO function also shuts off the output when the input voltage falls below its falling threshold.

Application Information

Input capacitor

The APL5320/A requires proper input capacitors to supply surge current during stepping load transients to prevent the input rail from dropping. Because the parasitic inductor from the voltage sources or other bulk capacitors to the VIN limit the slew rate of the surge current, place the Input capacitors near VIN as close as possible. Input capacitors should be larger than 1μF and a minimum ceramic capacitor of 1μF is necessary.

Output Capacitor

The APL5320/A needs a proper output capacitor to maintain circuit stability and improve transient response over-temperature and current. In order to insure the circuit stability, the proper output capacitor value should be larger than 1μF. With X5R and X7R dielectrics, 1μF is sufficient at all operating temperatures. Large output capacitor value can reduce noise and improve load-transient response and PSRR, Figure 1 shows the curves of allowable ESR range as the function of load current for various output capacitor values.

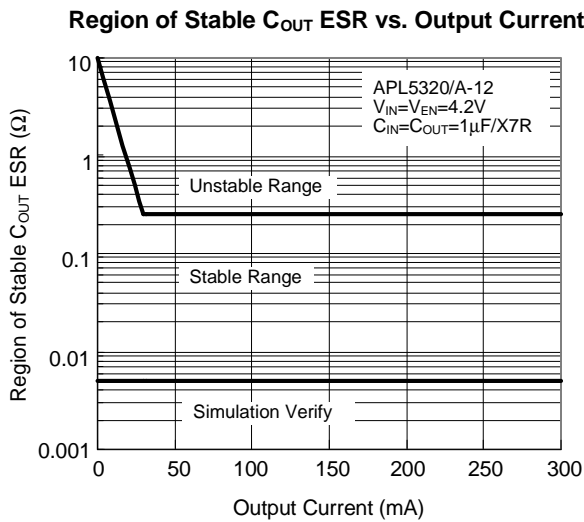

Figure1. Stable C_{OUT} ESR Range

Operation Region and Power Dissipation

The APL5320/A maximum power dissipation depends on the thermal resistance and temperature difference between the die junction and ambient air. The TDFN1.6x1.6-6 package power dissipation P_D across the device is:

$$P_D = (T_J - T_A) / \theta_{JA}$$

where (T_J - T_A) is the temperature difference between the junction and ambient air. θ_{JA} is the thermal resistance between Junction and ambient air. Assuming the T_A=25°C and maximum T_J=160°C (typical thermal limit threshold), the maximum power dissipation is calculated as:

$$P_D(\text{max})=(160-25)/165=0.81(\text{W})$$

For normal operation, do not exceed the maximum junction temperature rating of T_J=125°C. The calculated power dissipation should be less than:

$$P_D=(125-25)/165=0.6(\text{W})$$

The GND provides an electrical connection to the ground and channels heat away. Connect the GND to the ground by using a large pad or a ground plane.

Layout Consideration

Figure 2 illustrates the layout. Below is a checklist for your layout:

1. Please place the input capacitors close to the VIN.
2. Ceramic capacitors for load must be placed near the load as close as possible.
3. To place APL5320/A and output capacitors near the load is good for performance.
4. Large current paths, the bold lines in figure 2, must have wide tracks.

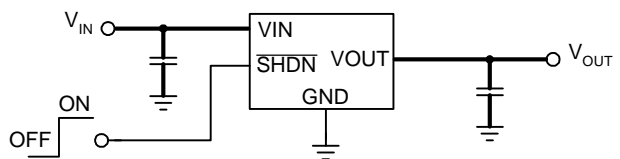
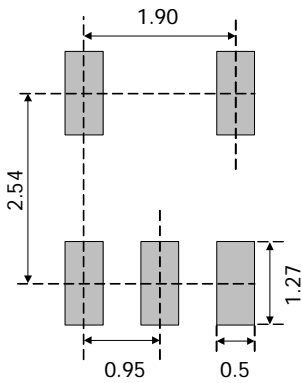

Figure2. Large Current Paths Shown as Bold Lines

Application Information(Cont.)

Recommended Minimum Footprint



Unit: mm

SOT-23-5/TSOT-23-5

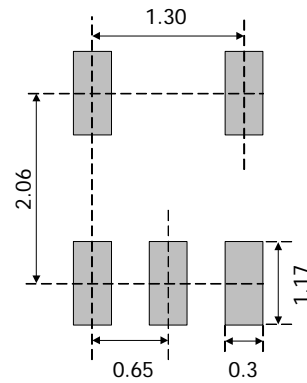

Unit: mm

SC-70-5

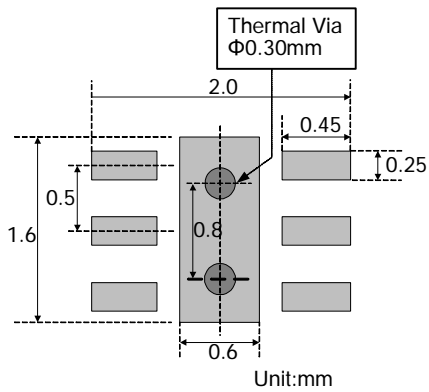

Unit:mm

TDFN1.6x1.6-6

Package Information

SOT-23-5

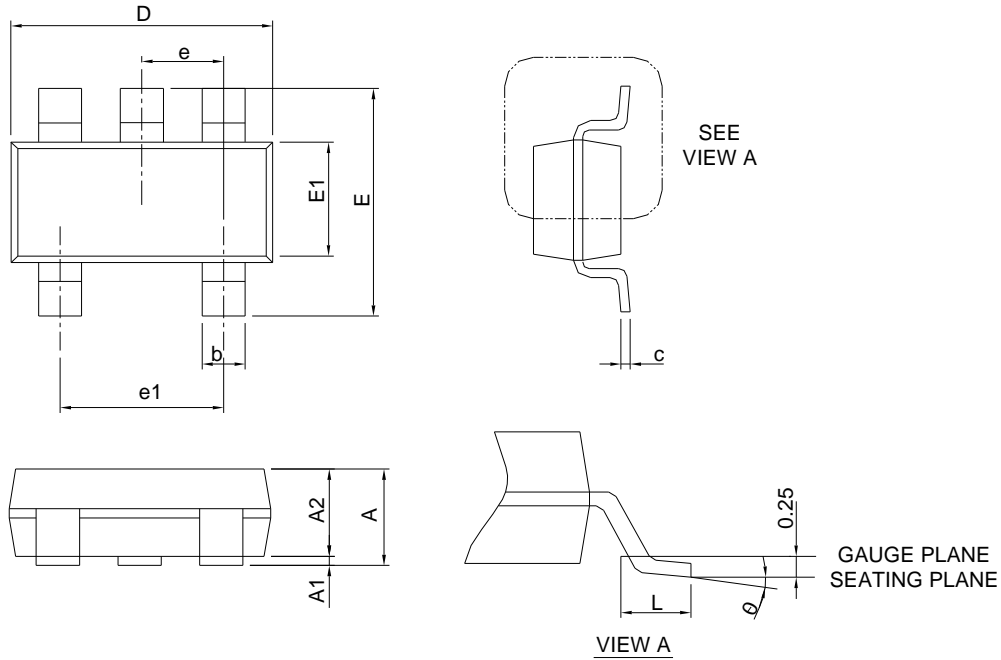

SYMBOL	SOT-23-5			
	MILLIMETERS		INCHES	
	MIN.	MAX.	MIN.	MAX.
A		1.45		0.057
A1	0.00	0.15	0.000	0.006
A2	0.90	1.30	0.035	0.051
b	0.30	0.50	0.012	0.020
c	0.08	0.22	0.003	0.009
D	2.70	3.10	0.106	0.122
E	2.60	3.00	0.102	0.118
E1	1.40	1.80	0.055	0.071
e	0.95 BSC		0.037 BSC	
e1	1.90 BSC		0.075 BSC	
L	0.30	0.60	0.012	0.024
θ	0°	8°	0°	8°

Note : 1. Follow JEDEC TO-178 AA.
 2. Dimension D and E1 do not include mold flash, protrusions or gate burrs. Mold flash, protrusion or gate burrs shall not exceed 10 mil per side.

Package Information

TSOT-23-5

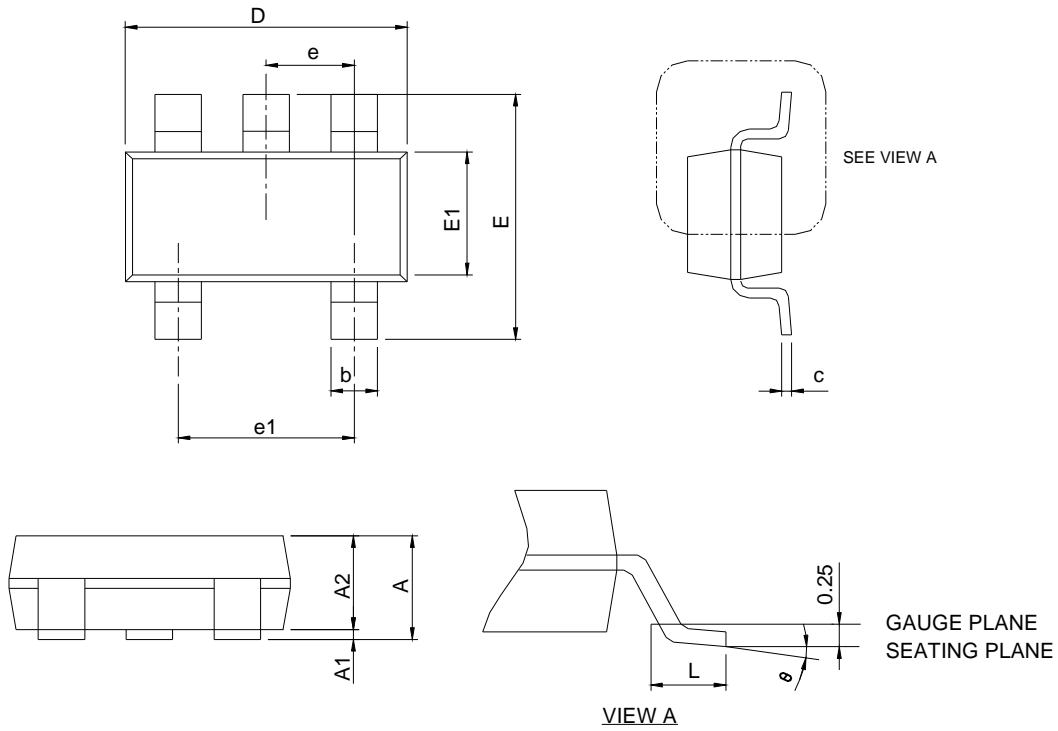

SYMBOL	TSOT-23-5			
	MILLIMETERS		INCHES	
	MIN.	MAX.	MIN.	MAX.
A	0.70	1.00	0.028	0.039
A1	0.01	0.10	0.000	0.004
A2	0.70	0.90	0.028	0.035
b	0.30	0.50	0.012	0.020
c	0.08	0.22	0.003	0.009
D	2.70	3.10	0.106	0.122
E	2.60	3.00	0.102	0.118
E1	1.40	1.80	0.055	0.071
e	0.95 BSC		0.037 BSC	
e1	1.90BSC		0.075 BSC	
L	0.30	0.60	0.012	0.024
θ	0°	8°	0°	8°

Note : 1. Followed from JEDEC TO-178 AA.
 2. Dimension D and E1 do not include mold flash, protrusions or gate burrs. Mold flash, protrusion or gate burrs shall not exceed 10 mil per side.

Package Information

SC-70-5

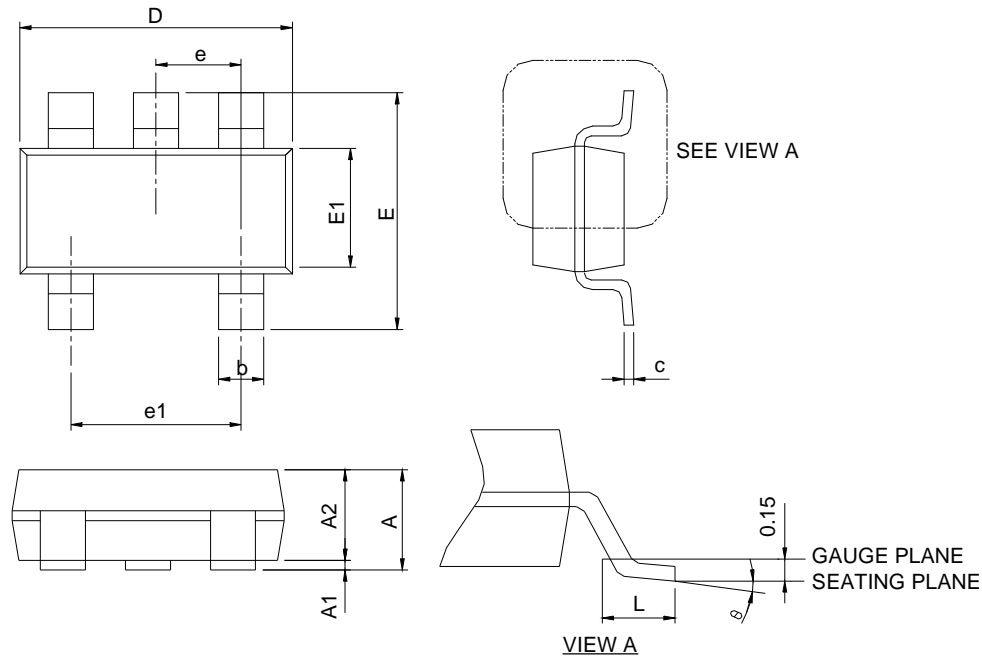

SYMBOL	SC-70-5			
	MILLIMETERS		INCHES	
	MIN.	MAX.	MIN.	MAX.
A	0.80	1.10	0.031	0.043
A1	0.00	0.10	0.000	0.004
A2	0.80	1.00	0.031	0.040
b	0.15	0.30	0.006	0.012
c	0.08	0.25	0.003	0.010
D	1.90	2.20	0.075	0.087
E	2.00	2.40	0.079	0.095
E1	1.15	1.35	0.045	0.053
e	0.65 BSC		0.026 BSC	
e1	1.30 BSC		0.051 BSC	
L	0.15	0.45	0.006	0.018
θ	0°	8°	0°	8°

Note : 1. Followed from JEDEC MO-223 AB.
 2. Dimension D and E1 do not include mold flash, protrusions or gate burrs.
 Mold flash, protrusion or gate burrs shall not exceed 6 mil per side.

Package Information

SC-82-4

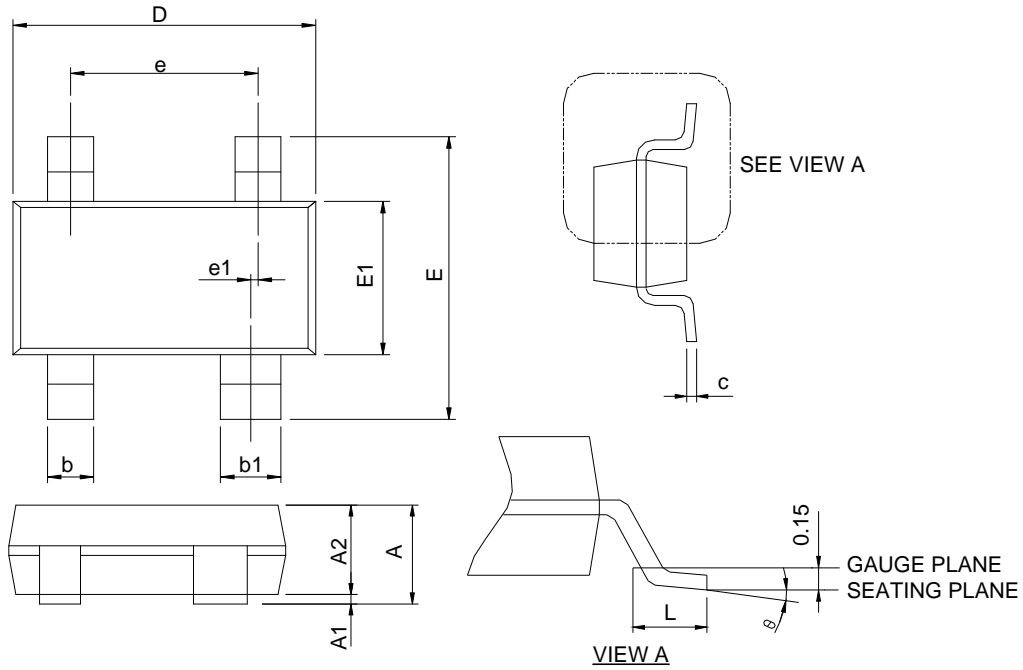

DIMENSIONS	SC-82			
	MILLIMETERS		INCHES	
	MIN.	MAX.	MIN.	MAX.
A	0.90	1.10	0.035	0.043
A1	0.00	0.10	0.000	0.004
A2	0.90	1.00	0.035	0.040
b	0.25	0.40	0.010	0.016
b1	0.35	0.50	0.014	0.020
c	0.08	0.15	0.003	0.006
D	2.00	2.20	0.079	0.087
E	2.15	2.45	0.085	0.096
E1	1.15	1.35	0.045	0.053
e	1.30 BSC		0.051 BSC	
e1	0.05 BSC		0.002 BSC	
L	0.26	0.46	0.010	0.018
θ	0°	8°	0°	8°

Note : 1. Dimension D and E1 do not include mold flash, protrusions or gate burrs. Mold flash, protrusion or gate burrs shall not, exceed 6 mil per side.

Package Information

SOT-23-3

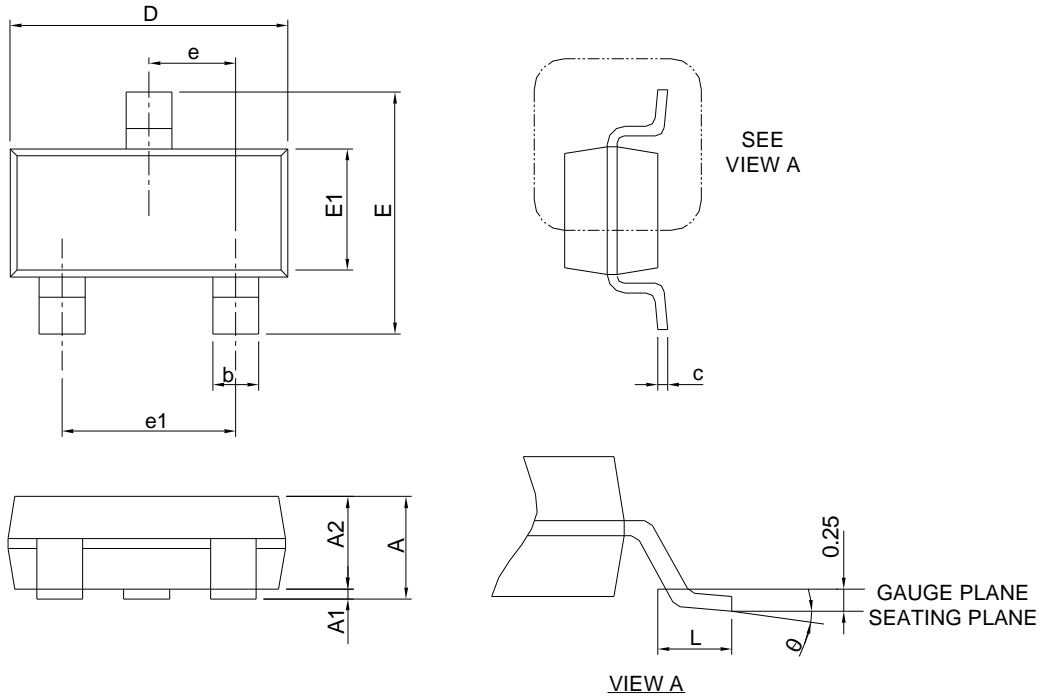

SYMBOL	SOT-23-3			
	MILLIMETERS		INCHES	
	MIN.	MAX.	MIN.	MAX.
A		1.45		0.057
A1	0.00	0.15	0.000	0.006
A2	0.90	1.30	0.035	0.051
b	0.30	0.50	0.012	0.020
c	0.08	0.22	0.003	0.009
D	2.70	3.10	0.106	0.122
E	2.60	3.00	0.102	0.118
E1	1.40	1.80	0.055	0.071
e	0.95 BSC		0.037 BSC	
e1	1.90 BSC		0.075 BSC	
L	0.30	0.60	0.012	0.024
θ	0°	8°	0°	8°

Note : Dimension D and E1 do not include mold flash, protrusions or gate burrs. Mold flash, protrusion or gate burrs shall not exceed 10 mil per side.

Package Information

TDFN1.6x1.6-6

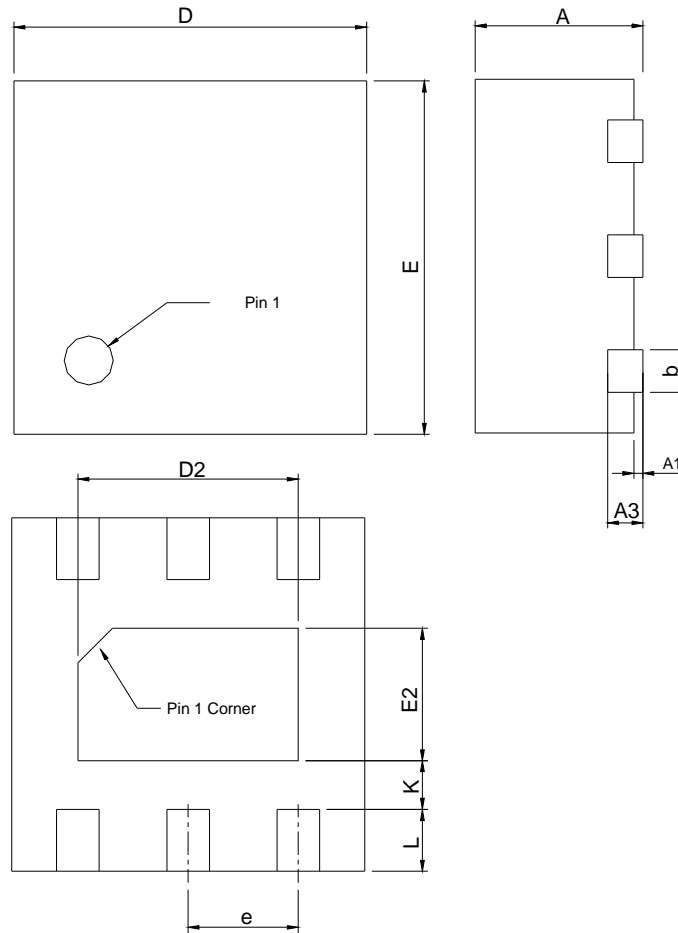

DIMENSIONS	TDFN1.6x1.6-6			
	MILLIMETERS		INCHES	
	MIN.	MAX.	MIN.	MAX.
A	0.70	0.80	0.028	0.031
A1	0.00	0.05	0.000	0.002
A3	0.20 REF		0.008 REF	
b	0.20	0.30	0.008	0.012
D	1.55	1.65	0.061	0.065
D2	0.95	1.05	0.037	0.041
E	1.55	1.65	0.061	0.065
E2	0.55	0.65	0.022	0.026
e	0.50 BSC		0.020 BSC	
K	0.20	-	0.008	-
L	0.19	0.29	0.007	0.011

Package Information

TDFN1.5x1.5-6

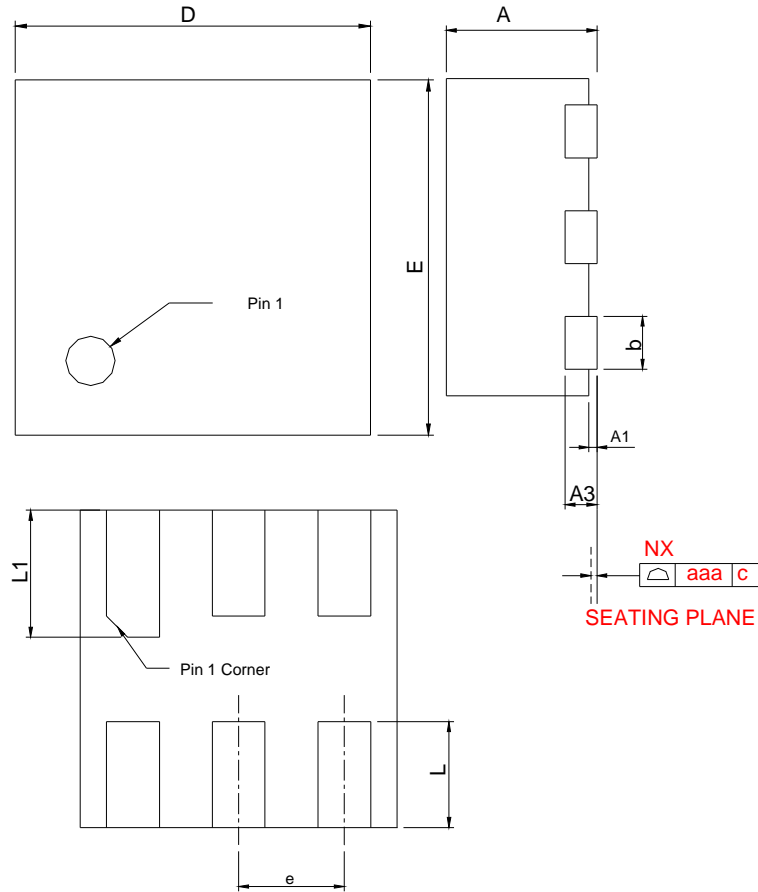

SYMBOL	TDFN1.5x1.5-6			
	MILLIMETERS		INCHES	
	MIN.	MAX.	MIN.	MAX.
A	0.70	0.80	0.028	0.031
A1	0.00	0.05	0.000	0.002
A3	0.20 REF		0.008 REF	
b	0.20	0.30	0.008	0.012
D	1.45	1.55	0.057	0.061
E	1.45	1.55	0.057	0.061
e	0.50BSC		0.020 BSC	
L	0.40	0.60	0.016	0.024
L1	0.50	0.70	0.020	0.028
aaa	0.08		0.003	

Carrier Tape & Reel Dimensions

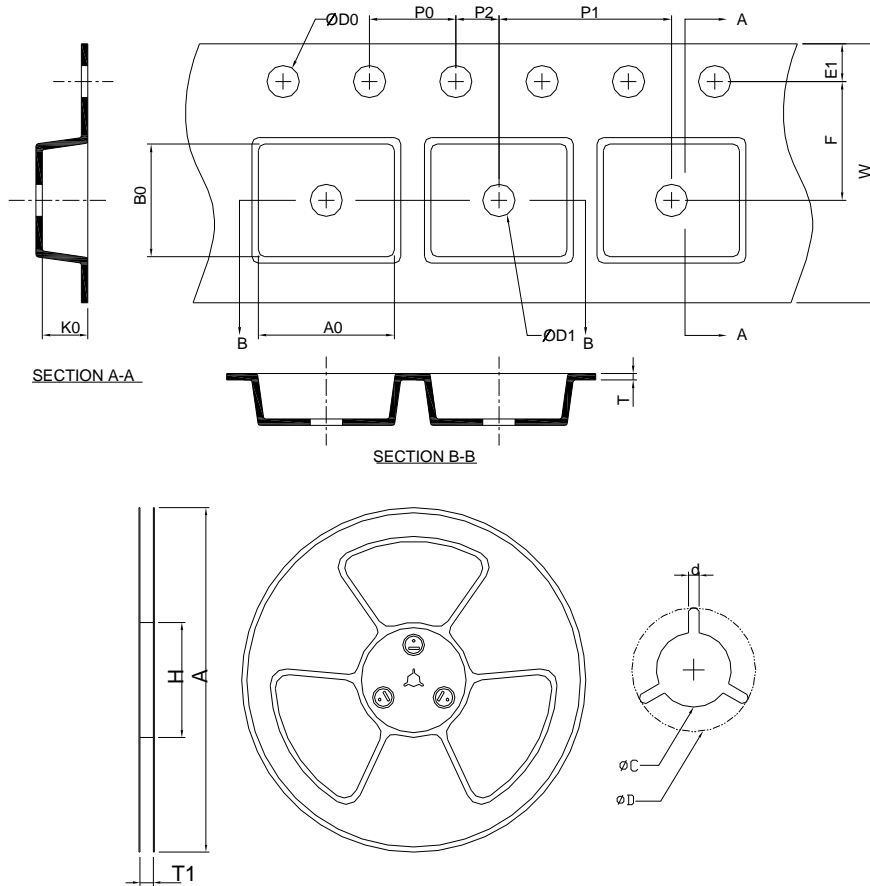

Application	A	H	T1	C	d	D	W	E1	F
SOT-23-5	178.0±2.00	50 MIN.	8.4+2.00 -0.00	13.0+0.50 -0.20	1.5 MIN.	20.2 MIN.	8.0±0.30	1.75±0.10	3.5±0.05
	P0	P1	P2	D0	D1	T	A0	B0	K0
	4.0±0.10	4.0±0.10	2.0±0.05	1.5+0.10 -0.00	1.0 MIN.	0.6+0.00 -0.40	3.20±0.20	3.10±0.20	1.50±0.20
Application	A	H	T1	C	d	D	W	E1	F
TSOT-23-5	178.0±2.00	50 MIN.	8.4+2.00 -0.00	13.0+0.50 -0.20	1.5 MIN.	20.2 MIN.	8.0±0.30	1.75±0.10	3.5±0.05
	P0	P1	P2	D0	D1	T	A0	B0	K0
	4.0±0.10	4.0±0.10	2.0±0.05	1.5+0.10 -0.00	1.0 MIN.	0.6+0.00 -0.40	3.20±0.20	3.10±0.20	1.50±0.20
Application	A	H	T1	C	d	D	W	E1	F
SOT-23-3	178.0±2.00	50 MIN.	8.4+2.00 -0.00	13.0+0.50 -0.20	1.5 MIN.	20.2 MIN.	8.0±0.30	1.75±0.10	3.5±0.05
	P0	P1	P2	D0	D1	T	A0	B0	K0
	4.0±0.10	4.0±0.10	2.0±0.05	1.5+0.10 -0.00	1.0 MIN.	0.6+0.00 -0.40	3.20±0.20	3.10±0.20	1.50±0.20

(mm)

Carrier Tape & Reel Dimensions (Cont.)

Application	A	H	T1	C	d	D	W	E1	F
SC-70-5	178.0±2.00	50 MIN.	8.4+2.00 -0.00	13.0+0.50 -0.20	1.5 MIN.	20.2 MIN.	8.0±0.30	1.75±0.10	3.50±0.05
	P0	P1	P2	D0	D1	T	A0	B0	K0
	4.0±0.10	4.0±0.10	2.0±0.05	1.5+0.10 -0.00	1.00 MIN.	0.6+0.00 -0.40	2.40±0.20	2.40±0.20	1.20±0.20
Application	A	H	T1	C	d	D	W	E1	F
TDFN1.6x1.6-6	178.0±2.00	50 MIN.	8.4+2.00 -0.00	13.0+0.50 -0.20	1.5 MIN.	20.2 MIN.	8.0±0.30	1.75±0.10	3.5±0.05
	P0	P1	P2	D0	D1	T	A0	B0	K0
	4.0±0.10	4.0±0.10	2.0±0.05	1.5+0.10 -0.00	1.5 MIN.	0.6+0.00 -0.40	1.70±0.20	1.70±0.20	0.90±0.20
Application	A	H	T1	C	d	D	W	E1	F
SC-82-4	178.0±2.00	50 MIN.	8.4+2.00 -0.00	13.0+0.50 -0.20	1.5 MIN.	20.2 MIN.	8.0±0.30	1.75±0.10	3.50±0.05
	P0	P1	P2	D0	D1	T	A0	B0	K0
	4.0±0.10	4.0±0.10	2.0±0.05	1.5+0.10 -0.00	1.00 MIN.	0.6+0.00 -0.40	2.40±0.20	2.40±0.20	1.20±0.20
Application	A	H	T1	C	d	D	W	E1	F
TDFN1.5x1.5-6	178.0±2.00	50 MIN.	8.4+2.00 -0.00	13.0+0.50 -0.20	1.5 MIN.	20.2 MIN.	8.0±0.30	1.75±0.10	3.5±0.05
	P0	P1	P2	D0	D1	T	A0	B0	K0
	4.0±0.10	4.0±0.10	2.0±0.05	1.5+0.10 -0.00	1.5 MIN.	0.6+0.00 -0.40	1.80±0.20	1.80±0.20	1.00±0.20

(mm)

Devices Per Unit

Package Type	Unit	Quantity
SOT-23-5	Tape & Reel	3000
TSOT-23-5	Tape & Reel	3000
SOT-23-3	Tape & Reel	3000
SC-70-5	Tape & Reel	3000
TDFN1.6x1.6-6	Tape & Reel	3000
SC-82-4	Tape & Reel	3000
TDFN1.5x1.5-6	Tape & Reel	3000

Taping Direction Information (Cont.)

SOT-23-3

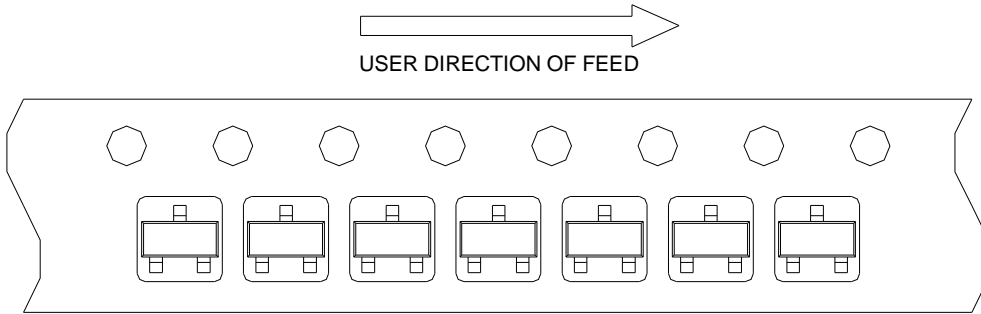

SC-70-5

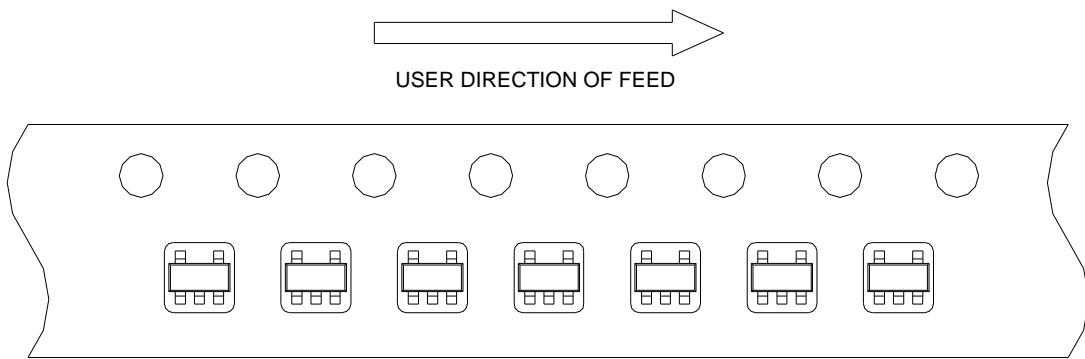

TDFN1.6x1.6-6

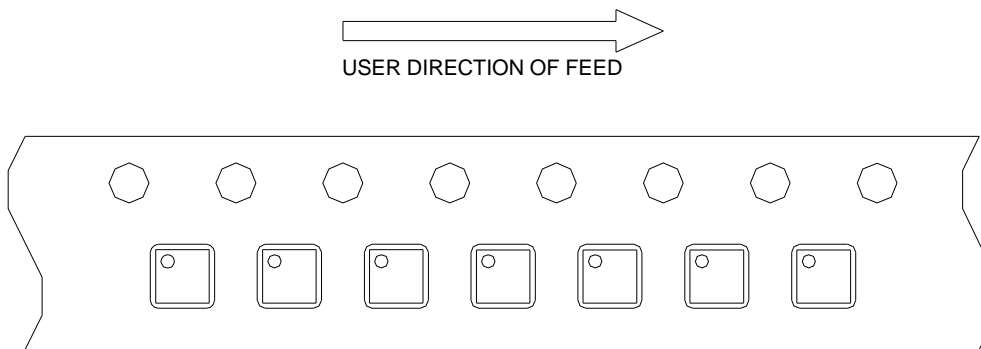

Taping Direction Information

(T)SOT-23-5

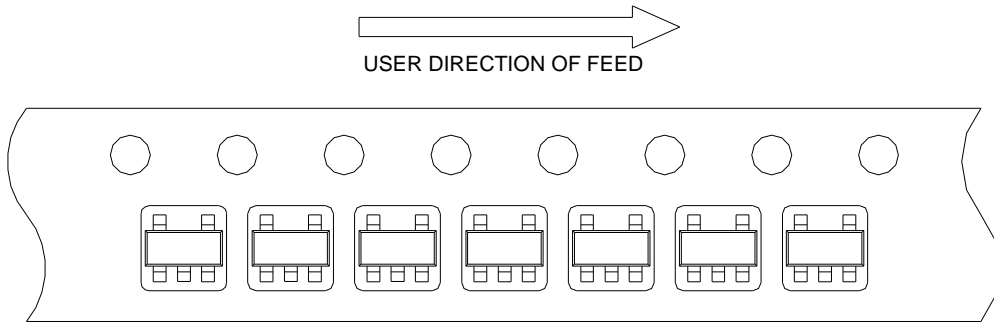

SC-82-4

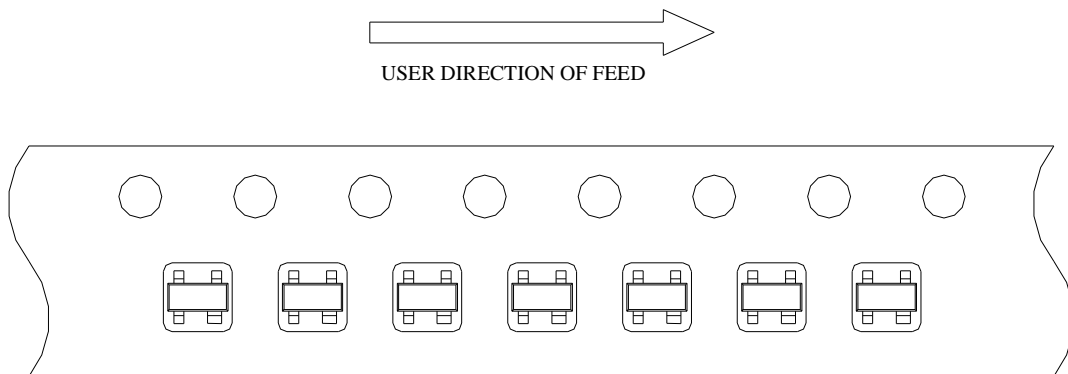

TDFN1.5x1.5-6

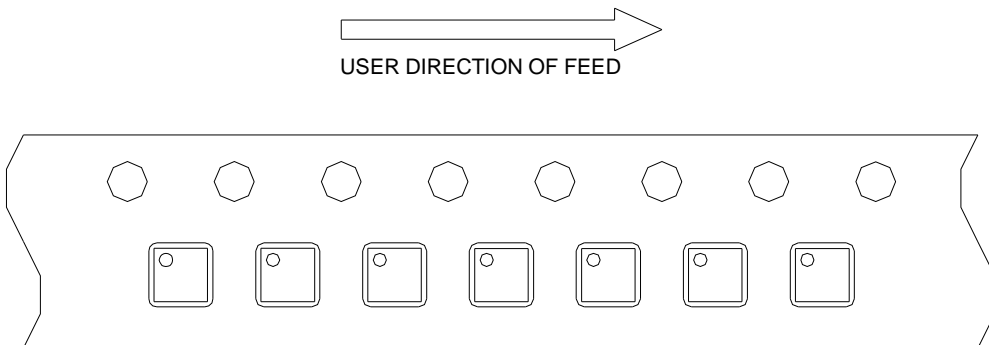

Classification Profile

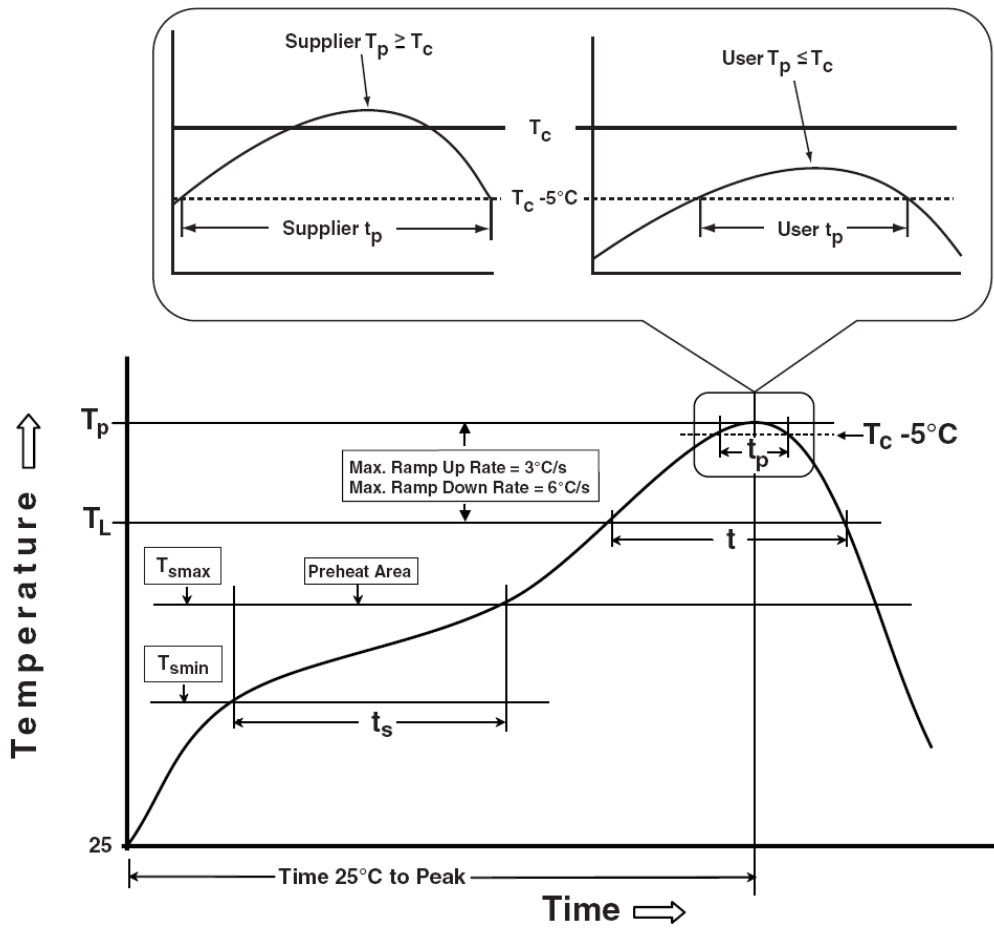

Classification Reflow Profiles

Profile Feature	Sn-Pb Eutectic Assembly	Pb-Free Assembly
Preheat & Soak		
Temperature min (T_{smin})	100 °C	150 °C
Temperature max (T_{smax})	150 °C	200 °C
Time (T_{smin} to T_{smax}) (t_s)	60-120 seconds	60-120 seconds
Average ramp-up rate (T_{smax} to T_p)	3 °C/second max.	3 °C/second max.
Liquidous temperature (T_L)	183 °C	217 °C
Time at liquidous (t_L)	60-150 seconds	60-150 seconds
Peak package body Temperature (T_p)*	See Classification Temp in table 1	See Classification Temp in table 2
Time (t_p)** within 5°C of the specified classification temperature (T_c)	20** seconds	30** seconds
Average ramp-down rate (T_p to T_{smax})	6 °C/second max.	6 °C/second max.
Time 25°C to peak temperature	6 minutes max.	8 minutes max.
* Tolerance for peak profile Temperature (T_p) is defined as a supplier minimum and a user maximum.		
** Tolerance for time at peak profile temperature (t_p) is defined as a supplier minimum and a user maximum.		

Table 1. SnPb Eutectic Process – Classification Temperatures (T_c)

Package Thickness	Volume mm ³ <350	Volume mm ³ ≥350
<2.5 mm	235 °C	220 °C
≥2.5 mm	220 °C	220 °C

Table 2. Pb-free Process – Classification Temperatures (T_c)

Package Thickness	Volume mm ³ <350	Volume mm ³ 350-2000	Volume mm ³ >2000
<1.6 mm	260 °C	260 °C	260 °C
1.6 mm – 2.5 mm	260 °C	250 °C	245 °C
≥2.5 mm	250 °C	245 °C	245 °C

Reliability Test Program

Test item	Method	Description
SOLDERABILITY	JESD-22, B102	5 Sec, 245°C
HOLT	JESD-22, A108	1000 Hrs, Bias @ $T_j=125^\circ\text{C}$
PCT	JESD-22, A102	168 Hrs, 100%RH, 2atm, 121°C
TCT	JESD-22, A104	500 Cycles, -65°C~150°C
HBM	MIL-STD-883-3015.7	VHBM ≥ 2KV
MM	JESD-22, A115	VMM ≥ 200V
Latch-Up	JESD 78	10ms, $1_{tr} \geq 100\text{mA}$

Customer Service

Anpec Electronics Corp.

Head Office :

No.6, Dusing 1st Road, SBIP,
Hsin-Chu, Taiwan, R.O.C.
Tel : 886-3-5642000
Fax : 886-3-5642050

Taipei Branch :

2F, No. 11, Lane 218, Sec 2 Jhongsing Rd.,
Sindian City, Taipei County 23146, Taiwan
Tel : 886-2-2910-3838
Fax : 886-2-2917-3838

X-ON Electronics

Largest Supplier of Electrical and Electronic Components

Click to view similar products for [LDO Voltage Regulators](#) category:

Click to view products by [Anpec](#) manufacturer:

Other Similar products are found below :

[M38D29FFHP#U1](#) [702103A](#) [717726C](#) [742457H](#) [MP20051DN-LF-Z](#) [R5F111PGGFB#30](#) [AP7363-SP-13](#) [NCP103AMX285TCG](#)
[NCV8664CST33T3G](#) [NCV8752AMX28TCG](#) [L9454](#) [AP7362-HA-7](#) [LX13043CLD](#) [TCR3DF185,LM\(CT](#) [TCR3DF24,LM\(CT](#)
[TCR3DF285,LM\(CT](#) [TCR3DF31,LM\(CT](#) [TCR3DF45,LM\(CT](#) [TLF4949EJ](#) [L9708](#) [L970813TR](#) [030014BB](#) [059985X](#) [EAN61387601](#)
[EAN61573601](#) [NCP121AMX173TCG](#) [NCP4687DH15T1G](#) [NCV8703MX30TCG](#) [701326R](#) [702087BB](#) [755078E](#) [TCR2EN28,LF\(S](#)
[LM1117DT-1.8/NO](#) [LT1086CM#TRPBF](#) [AZ1085S2-1.5TRE1](#) [MAX15101EWL+T](#) [NCV8170AXV250T2G](#) [SCD337BTG](#)
[TCR3DF27,LM\(CT](#) [TCR3DF19,LM\(CT](#) [TCR3DF125,LM\(CT](#) [TCR2EN18,LF\(S](#) [MAX15103EWL+T](#) [TS2937CZ-5.0 C0](#) [MAX8878EUK30-](#)
[T](#) [MAX663CPA](#) [NCV4269CPD50R2G](#) [NCV8716MT30TBG](#) [AZ1117IH-1.2TRG1](#) [MP2013GQ-P](#)